



PRICE LIST - 2018-19
(VOL - 01)



COMPOSITE LAB LINE PVT LTD

Lab Equipment's, Mol Bio Kit's & Reagent's, Glassware's, Plastic ware's

www.compositelabline.com



In order to fulfill all of our customers requirements, some of our products are available in three different qualities:

1- Basic Line:

The most competitive option

2 - Essential Line:

The best price-quality ratio

3 - Premium Line:

They are differentiated from the standard products by some relevant characteristics that make them suitable for specific applications destined to our most demanding clients, always keeping an excellent price-quality ratio

CLS offers a **wide range** of labware, Laboratory Essentials and Lab Furnishing / Modular laboratory furniture all together in the **same** product portfolio to make your purchase easier and quicker

LABWARE & EQUIPMENT

Attentive to your needs, we've created our own brands, easily identifiable by their logos, but we've also established collaborations with other manufacturers always in order to benefit from **the best price-quality ratio**



Our Product brands:

CLS: General labware and laboratory equipment.

CLS Instruments: range of small laboratory equipment. Outstanding quality at a very adjusted price.

CLS : Consumables and liquid handling instruments. From the simplest to the most sophisticated solution.

CLS : Our specialist Partner in filter paper.

CLS : Quality weighing equipments at affordable prices.

CLS : Offers accredited calibration services.

CLS : Lab Furnishing / Modular laboratory furniture.

Certification

Certificate of Registration

Awarded to

COMPOSITE LAB LINE PRIVATE LIMITED

A-1, O.K.K.P.COMPLEX, NEAR LT COLLEGE CROSSING, FAIZABAD ROAD, BABUGANJ, LUCKNOW-226020 UTTAR PRADESH INDIA.

It is Certified that Quality Management System of Organization has been audited and found to be in accordance with the requirements of

ISO 9001:2015

For the Scope of activities described below

MANUFACTURING OF LABORATORY EQUIPMENTS, PLASTICWARE, CHEMICAL GLASSWARE, LIFE SCIENCE APPLICATION PRODUCTS.

Certificate No : **16DQAC11**
 Initial Registration Date : 23-12-2016 Issuance Date : 23-12-2016
 Date of Expiry* : 22-12-2019
 Ist Surv. Due 23-11-2017 IIrd Surv. Due 23-11-2018

J. K. Verma
Managing Director



ROHS Certification Pvt. Ltd.

Accredited by: Delhi Accreditation Centre (DAC), Member of International Accreditation Forum (IAF)

Certificate of Compliance

Application of Council of Directive for Medical Devices Directive (MDD) 93/42/EEC.

This is to Certify that the technical documentation of the company

COMPOSITE LAB LINE PRIVATE LIMITED

A-1, O.K.K.P. COMPLEX, NEAR LT COLLEGE CROSSING, FAIZABAD ROAD, BABUGANJ, LUCKNOW-226020, UTTAR PRADESH, INDIA

for the product

MANUFACTURING OF LABORATORY PRODUCTS

(ANNEXURE-I)

Has been assessed and found to conform to the requirements of Medical Devices Directive (MDD) 93/42/EEC. This certificate refers to the information examined and read with manufacturer's declaration of conformity. Further, the product liability rests with the Manufacturer or his representative in accordance with the council Directive 85/374/EEC.

Certificate No : **17DCAE50**

Initial Registration Date : 05.04.2017 Issuance Date : 05.04.2017
 Date of Expiry* : 04.04.2020
 Ist Surv. Due : 05.03.2018 II Surv. Due : 05.03.2019

A. K. Verma
Director



ROHS Certification Pvt. Ltd.

406, Madhuban Building, 55, Nehru Place, New Delhi-110 028 India | T: +91 11 22127777 | E: info@rohs-cert.com, sales@rohs-cert.com, www.rohs-cert.com

GOVERNMENT OF INDIA
 MINISTRY OF COMMERCE AND FOREIGN TRADE
 OFFICE OF Jt. DIRECTOR GENERAL OF FOREIGN TRADE
 117/1-A&A, KAROL BAGH, NEW DELHI-110002

1. Firm Name: COMPOSITE LAB LINE PRIVATE LIMITED

2. Firm Address: 610/202 D, KEDHAR NAGAR NEAR B.S.N.L TOWER, STANLEY ROAD, LUCKNOW, U.P. 226020

3. Signature of Director: *Ajay Kishor Verma*
 AMAY KISHOR VERMA, DIRECTOR

4. Branches: NIL

5. Udyog Aadhaar Number: 0911000002

6. Date of Issue: 15.01.2012

7. Address of the Branch/Unit if any: LUCKNOW

8. Date of Issue: 15.01.2012

Udyog Aadhaar Memorandum

Type of Enterprise	Micro	Small	Medium
Manufacturing	A	B	C
Services	D	E	F
UJA#	09PA0011007		

1. Aadhaar Number: 42019816481
 2. PAN Number: AACCT383P
 3. Name of Entrepreneur: AJAY KISHOR VERMA
 4. Social Category of Entrepreneur: GENERAL
 5. Gender: Male
 6. Physical Handicap: No
 7. Name of Enterprise: COMPOSITE LAB LINE PVT LTD
 8. Type of Organization: Private Limited Company
 9. Location of Plant Details:

Sl No.	Plot/Over/Block No.	Name of Premises/Building/Village	Road/Street/Lane	Area/Locality	City	Pin	State	District
1	20 (Ramdas) Singh C	SHIK Pathshala Society Shivan	Balajige	Fazalabad Road	LUCKNOW	226020	UTTAR PRADESH	LUCKNOW

10. Date of commencement: 06/12/2006
 11. Previous Registrations details if any: None
 12. Previous Registrations details if any: None
 13. IFS Code: HOF0000039
 Bank Account: 036220004943
 14. Major Activity: MANUFACTURING

SN	NC 1 Digit	NC 4 Digit	NC 10 Digit Code	Activity Type
15	25	2520	2520200000000	Manufacturing

17. Persons employed: 8
 Investment (Plant & Machinery / Equipment): 5/20 to 10 Lakhs
 18. District Industry Centre: LUCKNOW

Declaration: I hereby declare that the information given above is true to the best of my knowledge. Any information, that may be required to be verified, shall be provided immediately before the concerned authority.

ROHS Certification Pvt. Ltd.
 (An ISO Certification Body Accredited by DAG, Delhi)

(ANNEXURE-I)

- OVEN (UNIVERSAL, INDUSTRIAL, LAB, CHROMATOGRAPHY, TRAY DRYING, HIGH TEMPERATURE)
- INCUBATOR (BOD, COOLING, TEMP. & HUMIDITY, CO2)
- ENVIRONMENTAL CHAMBER (PLANT GROWTH, STABILITY AND WALK-IN CHAMBER, COLD ROOM)
- WATER BATH (SEROLOGICAL, RECTANGULAR, CIRCULATING, HIGH TEMPERATURE, RE-CIRCULATING, COOLING, OIL, SAND, TISSUE FLUTATION, HIGH PRECISION BATH)
- AUTOClave (VERTICAL, DRY STERILIZER, HORIZONTAL, ROUND & HIGH PRESSURE STEAM BULK STERILIZER)
- CLEAN AIR EQUIPMENT (LAMINAR FLOW, BIO-SAFETY CABINET, AIR CURTAIN, FUME HOOD)
- DISTILLATION UNIT (GLASS/S.S. DISTILLATION, SINGLE, DOUBLE, TRIPLE AND QUARTZ DISTILLATION UNIT)
- SHAKER (WATER BATH, INCUBATOR, SLICES, ROTARY, WRIST ACTION, UNIVERSAL, GYRLARY SHAKERS)
- GLASSWARE (BIBAKER, FLASK, TEST TUBES, BURETTE, MEASURING CYLINDER, AND GLASS CONSUMABLES USE IN LABORATORIES)
- PLASTICWARE (BIBETTES, PCR TUBES, CENTRIFUGE TUBES, PETRIDISH, CRYO BOX, CRYO VIALS, MICRO TIPS, PCR TUBE RACKS, AND PLASTIC CONSUMABLES USE IN LABORATORIES)
- LIFE SCIENCE CONSUMABLES (PCR MASTER MIX, TAQ DNA, DNTP, AGAROSE, HBPS, CHAPS, HBPS AND OTHER LIFE SCIENCE CONSUMABLES USING IN LABORATORIES)
- ANIMAL CAGE AND ANIMAL HOUSE FURNITURE INSTRUMENTS AND CONSUMABLES.

Corporate Office: 406, Madhuban Building No. 55, Nehru Place, New Delhi-110028.
 E-mail: info@rohs-cert.com, sales@rohs-cert.com, www.rohs-cert.com
 Contact: 011-22127777

About us:

Composite Lab Line Pvt. Ltd offer a wide range of scientific goods including laboratory plastic ware, glassware, Disposable plastic ware, Liquid handling systems, Instruments & different kits.

Our CLS brand product are manufactured in state of art modern facilities and distributed through different warehouse across India.

Quality reliability and adherence have become the emblem of the Composite Lab Line Pvt Ltd.

CLS has enjoyed the trust of its reputed & loyal customers that include several CSIR Laboratories, Pharmaceutical Companies, Scientific, Health & Educational institution from the last 11 years.



Our Mission :

To enable our customers to improve the quality of life & make the society & environment cleaner, greener & healthier.

Our Vision :

To be the trusted and preeminent global provider to the research laboratories along with customer satisfaction as a final goal.

This catalog includes General Laboratory consumables such as General Labware, Cell culture products, Lab Essentials and Equipments. All our products are designed as per international standards of quality and parameters using high precision with finest quality Raw materials.

We believe that Our products would serve as most perfect for your research and we wish a great success for your work.

Reach us out

Get a Quote

Telephone

E-mail

Website

DEALER:

PRODUCT INDEX

01

Lab Instrument's (Import Range)

Range for Laboratory equipments, Electrophoresis Unit, Power Supply, Centrifuge, Dry Bath Incubator, Tissue Grinder, UV Transilluminator, UV Torch, Water Bath, Vortex Mixer, Weighing Balance, Rocking Shaker, Multiparameter, pH Meter, Magnetic Stirrer with Hot Plate

11

CLS (Liquid Handling Product's)

Micropipettes (single and multi channel) Electronic, pipette, Pipette Aid, Tips and Tubes, Gloves, Filters, PCR Tubes and Plates, Sealing Films, Cuvette, Parailm etc.

23

CLS (Import Range) Pasticware

Laboratory Plasticware including, boxes, racks, weighing boats and Centrifuge, shaker, Vortex etc.

60

CLS Clinical & Pathology Product's

Laboratory Plasticwares, Microscopic Slides, Filter Tips, Serological Pipettes etc.

66

CLS (Molecular Biology Products)

DNA Ladders, Protein Markers, Loading Dye, Taq DNA Polymerase, dNTPS, Trizol, PCR master mix, Biochemicals etc.

78

CLS Cell Culture Plasticware

81

CLS Laboratory Plasticware

103

CLS Laboratory Glassware

127

CLS General Lab Essentials

138

CLS HPLC Septa & Vials

147

CLS Kits & Reagent's

149

CLS Antibodies



342

CLS Elisa Kit's



MINI P -4, NEW GENERATION OF MINI VERTICAL ELECTROPHORESIS SYSTEM

The Mini P-4 Cell has set the new standard for Mini Vertical Electrophoresis:

Easier to assemble, leakproof, and with a four-gel capacity that doubles the output of the traditional cell, the Mini P-4 cell combines traditional features with higher throughput and even greater reliability.

Modular Cells for Many Applications Interchangeable modules easily convert a Mini P-4 cell from one application to another. Each module fits into the same buffer tank and lid to form a complete cell.

The modular configurations are:

Mini P-4 electrophoresis cell — for running handcast or precast PAGE gel and (SDS)-PAGE gels

Mini TBC electrophoretic transfer cell — for western blotting

The Mini-P-4 cell is ideal for your vertical mini gel electrophoresis needs. Easy to use, easy to assemble, robust, and versatile, the cell accommodates up to four handcast or precast gels. Casting and running gels have never been quicker or easier.

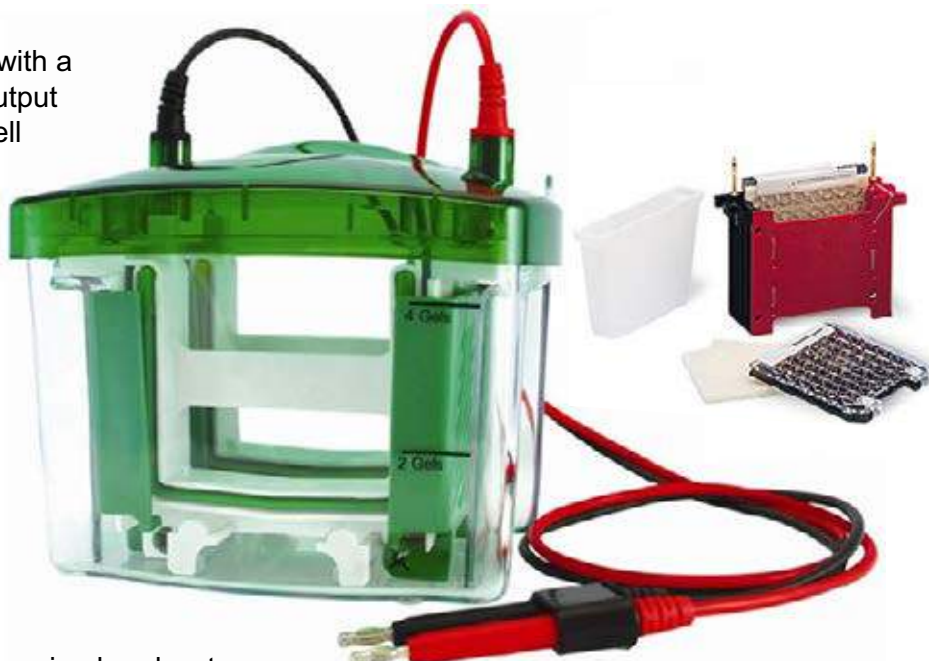

Specifications:

Number of gels	1–4
Precast gels	precast gels
Handcast gels	Cast using spacer plates
Glass plate size (W x L)	
Short plate	10.1 x 7.3 cm
Spacer plate	10.1 x 8.2 cm
Gel size (W x L)	
Handcast	8.3 x 7.3 cm
Precast	8.6 x 6.8 cm
Total buffer volume for 2 gels	700 ml
Total buffer volume for 4 gels	1,000 ml
Typical run times for SDS-PAGE	35–45 min (at 200 V constant)
Recommended power supply	Power B or Power BC
Dimensions (W x L x H)	12 x 16 x 18 cm

- Run up to 4 mini gels in less than an hour
- Run four 2-D gels in less than a day
- Evaluate sample preparation conditions
- Screen new samples and process discovery projects



MINI TBC ELECTROPHORETIC TRANSFER CELL

The Mini TBC cell is the perfect complement to the Mini P-4 vertical electrophoresis system.

- Transfers two mini format (7.5 x10 cm) gels in as little as 1 hour
- Cooling unit prevents buffer depletion during high-intensity transfers
- Cell performs low-intensity transfers by running at low voltage overnight
- Sturdy molded design protects platinum wire electrodes from breaking.



Specifications:

Transfer type	Tank
Blotting area	7.5 x 10 cm
No of cassettes	2
Buffer requirement	450 ml
Electrode distance	4 cm
Transfer time	60 min
Cooling	Blue-Ice cooling unit



Product Information

Cat No.	Product Description	Price
CLS-8000	Mini P-4 Vertical Electrophoresis System, 0.75 mm, 4 gels Includes: Mini P-4 electrophoresis cell (4 gels) 2 casting stands, 4 casting frames, 5 sets of glass plates, 10-well combs x5, sample loading guide, instructions	1,35,000.00
CLS-8001	Mini P-4 Vertical Electrophoresis System, 1.0 mm, 4 gels system, same as MP-8000 and 1.0 mm gel thickness	1,35,000.00
CLS-8005	Mini P-4 Vertical Electrophoresis System, 1.5 mm, 4 gels system same as MP-8000 and 1.5 mm gel Thickness.	1,35,000.00
CLS-8002	Mini P-4 Vertical Electrophoresis System, 0.75 mm, 2 gels, Includes: Mini P-4 electrophoresis cell (2 gels), casting stands, 2 casting frames, 5 sets of glass plates, 10-well combs x5, sample loading guide, instructions	98,000.00
CLS-8003	Mini P-4 Vertical Electrophoresis System, 1.0 mm, 2 gels system same as MP-8002 but 1.0 mm gel thickness.	98,000.00
CLS-8006	Mini P-4 Vertical Electrophoresis System, 1.5 mm, 2 gels system same as MP-8002 but 1.0 mm gel thickness.	98,000.00
CLS-1100	Short Plate, 5 per pack	3,000.00

Product Information

Cat No.	Product Description	Price
CLS-1101	Spacer Plate, 0.75 mm, 5 per pack	9,900.00
CLS-1102	Spacer Plate, 1.0 mm, 5 per pack	9,900.00
CLS-1103	Spacer Plate, 1.5 mm, 5 per pack	9,900.00
CLS-1200	Comb, 0.75 mm, 10-well, 33 ul/well, 5 per pack	8,900.00
CLS-1201	Comb, 1.0 mm, 10-well, 44 ul/well, 5 per pack	8,900.00
CLS-1202	Comb, 1.5 mm, 10-well, 66 ul/well, 5 per pack	8,900.00
CLS-1203	Comb, 0.75 mm, 15-well, 20 ul/well, 5 per pack	8,900.00
CLS-1204	Comb, 1.0 mm, 15-well, 26 ul/well, 5 per pack	8,900.00
CLS-1205	Comb, 1.5 mm, 15-well, 39 ul/well, 5 per pack	8,900.00
CLS-1206	2-D/Prep comb, 1.0 mm, 5 per pack	8,900.00
CLS-3030	Mini-TBC electrophoretic transfer cell, includes: Mini P-4 cell tank and lid with cables, buffer, Mini transfer module, 2 gel holder cassettes, 4 fiber pads, cooling units, instructions	85,000.00
CLS-3035	Mini-TBC trans blot module: includes: Mini transfer module, 2 gel holder cassettes, 4 fiber pads, cooling units, instructions	70,500.00
CLS-1150	Power B Power Supply, 300V / 400mA / 75W	1,00,640.00
CLS-1152	Power BC Power Supply, 300V / 2.0A / 200W	1,22,000.00



Horizontal Electrophoresis



Specifications:

Gel Plate dimensions	120 X 120 (mm); 120 X 60 (mm); 60 X 120 (mm); 60 X 60 (mm)
Runs up to	13, 18, 25 Samples
Comb thickness	1.0, 1.5 & 2.0 mm
Bufur Volume	650 ml
Weight	1 Kg
Size (LXWXH)	310X150X90(mm)
Price	38000.00

Horizontal Electrophoresis



Speiications:

MODEL	CLS-MH008
Dimension :	18.5cm (L) x9.5cm (B) x7cm(H)
Number of Samples:	8
Bufur Volume :	300 ml
Number of casting Tray :	7x5cm,10x7cm(1 No.Each)
Number of Combs:	8 wells 1.5mm thickness comb (Well Width-5mm, Interspace-3mm) (2 Nos.), 3wells 1.5mm thickness comb (Well Width-18mm, Interspace-4mm) (1Nos.).
Comb Capacity (5mm Deep Well) :	37ul, 132ul
Connecting Cord :	Red and Black (Each One)
No. of Platinum electrodes :	positive and negative (each one)
Bufur Chamber with Safety Lid :	1 No
Price	16,000.00

Horizontal Electrophoresis



Speiications:

MODEL	CLS-31N
Gel plate dimensions:	60x60 (mm);
Runs up to:	6 (1.5mm), 8 (1.5mm) or 11 (1.0mm, 1.5mm) samples;
Comb thickness:	1.0 mm and 1.5 mm;
Bufur volume:	120 ml
Weight:	about 0.5 kg
Size (L X W X H):	197 × 96 × 64 (mm)
Price	21,000.00

Horizontal Midi Gel Electrophoresis



Speiications:

MODEL	C-1110-01
No of Samples:	Upto 36
Bufur Volume:	400ml
Gel Size :	7x5cms, 13x6cms, 13x10cms
Dimension:	25.5cms(L) x 15.5cms (B) x 7cms(H)
Price	24,000.00

Maxi Horizontal Electrophoresis



Speiications:

MODEL	CLS2425
Gel area (WxL)	245 x 250 (mm)
No. of samples	19-364
Bufur capacity	2000 (ml)
Volume (LxWxH)	487 x 300 x 93 (mm)
Body tank with electrode	1
245 x 250 mm Gel tray	1
Gel casting	1
1.8 mm thickness 52 wells comb	2
1.0 mm thickness 46 wells comb	2
Price	1,05,000.00

Power Supply



Specifications:

MODEL	CLS-300V
Display	LCD
Output voltage / Inc.	2 - 300V / 1V
Output current / Inc.	1 - 700mA / 1mA
Output power / Inc.	150W
Operating	Constant voltage / Current
Controller	Microprocessor controller
Terminal pairs	4 Pairs
Timer	Constant mode:9999 (min) with alarm / Continuous
Pause function	Yes
Safety device	No-load detection Leakage detection Sudden load change detection Over temperature protection Overload detection Shrouded plug and sockets
Price (₹)	68,000.00

Digital Power Supply



Specifications:

MODEL	CLS-2003
Output range :	10–300 V, fully adjustable in 1 V steps,1-200 mA,fully adjustable in 1 mA steps
Type of output :	Constant voltage or constant current
Output terminals :	4 pair recessed banana jacks in parallel
Timer :	1 min–999 min , fully adjustable
Start /Stop Function :	Yes
Display :	3-digit LED
Operating conditions :	0–40°C, 0–90% humidity in the absence of condensation
Safety features :	No-load detection, sudden load change detection, overload/short-circuit detection,
Input protection :	Fuse on both hot and neutral
Input power (actual) :	220V AC/50hz
Price (₹)	35,000.00

Mini-Centrifuges



Specifications:

MODEL	CLS1008
Max. Speed/RCFxg	7000 rpm/2680 xg
Capacity	8 x 1.5/2.0ml microtubes. (8 x 0.5 & 8 x 0.2ml tubes using adapters)
Run Time	30 secs to 99 mins Timer or Continuous Operation
Dimensions	(W) 6 x (L) 6 x (H) 5 inches
Weight	2.1 lbs
Voltage	100-240V/50Hz/60Hz
Price (₹)	14,500.00

Plus Mini Centrifuge



Specifications:

MODEL	CLS-10K
Speed	3000rpm - 10000rpm (step 1000rpm)
Centrifugal Force	1000g - 7500 g
Sample Capacity	8 x 2.0ml/1.5ml/0.5ml/0.2ml tube (additional 0.5ml and 0.2ml tube carriers)2 x 8 x 0.2ml PCR tube strip (tube strip only used when speed≤6000rpm)
Time Range	1s - 999min
Noise	≤55 dB
Dimension	176x156x121 (mm)
Net Weight	≤1.5kg
Power	220V/110V 50-60HZ
Price (₹)	28,000.00

High Speed Micro Centrifuge



Specifications:

MODEL	CLS-12
Max. Speed	16000 rpm
Capacity	Standard Rotor 12X1.5/2ml
Run Time	Microprocessor based Digital Timer of range 0-15 min.
Fitted with well balance universal motor having long life with imported carbons	
Price (₹)	28,000.00

PCR Plate Centrifuge



Specifications:

Model	CLS-2500
Capacity	2 PCR Plates
Rotor Speed	2500 rpm
G Force	500 g
Rotor	Fixed Vertical
Dimensions	20 cm (w) x 23 cm (d) x 19.3 cm(h)
Weight	3 KG
Voltage	AC 100V-230V 50-60 Hz
Price (₹)	60,000.00

Dry Bath Incubator



Product technical parameters

Model Specification	CLS-100 Dry Bath Incubator (heating)	CLS-100 Dry Bath Incubator (Cooling)
Temperature Control Range	RT+5°C—100°C	-10°C—100°C
Temperature Control Accuracy 100°C	≤±0.5 °C	
Block Temp Diference 40°C	0.3 °C	
Block Temperature Uniformity	≤±0.3 °C	
Display Accuracy	0.1 °C	
Heating Time	≤15min (from 20 °C to 100 °C)	
Timing Range	99 h 59 min	
Maximum Temperature	100 °C	
Maximum Power	150 W	
Net Weight	2.2 Kg	
Dimension (LxWxH)	270 x 196 x 170 mm	
Block Selection	Refer to Exchangeable blocks for both the models	
Price	48,000.00	98,000.00

Tissue Grinder



Specifications:

MODEL	CLS-50
Power Supply:	12V DC 5A
Speed Range:	3000–8000 rpm
Motor Control:	Brushless motor with speed control servo system
Maximum Power	Output: 50W (continuous output)
Dimensions:	170 x 50 x 26 mm
Net Weight:	145g
Price	39,000.00

Thermoshaker Incubator



Specifications:

Model	CLS-100	CLS-100
Temperature Control Range	0°C- 100°C	R.T.+5°C- 100°C
Block Temperature Uniformity	≤±0.3°C	
Temperature Control Accuracy	±0.3°C	
Display Accuracy	0.1°C	
Heating Platform Temperature Accuracy	<0.5°C (detect @37°C)	
Shaking Speed	300 - 1500 rpm	300 - 2000 rpm
Shaking Orbit	3mm (horizontal)	
Timing Range	99 h 59 min	
Heating Time	<20min (from 20°C to 100°C)	
Cooling Time	≤25min from R.T. to R.T.-20°C	/
	(detected below 30°C)	
Cooling Speed	≥7°C/min (from 100°C to 20°C)	/
	≥1.2°C/min (from R.T. to R.T.-20°C)	
Price (₹)	1,75,000.00	98,000.00

Exchangeable blocks for Dry Bath Incubator & Thermoshaker

Type	Description	Price
A	96×0.2ml PCR plate	9,800.00
B	54×0.5ml	9,800.00
C	35×1.5ml	9,800.00
D	35×2.0ml	9,800.00
E	20×0.5ml+15×1.5ml	9,800.00
F	24×Dia. ≤ 12mm	9,800.00
G	32×0.2ml+25×1.5ml	9,800.00
H	32×0.2ml+10×0.5ml+15×1.5ml	9,800.00
I	103×67×30mm (water bath block)	9,800.00
J	96×0.2ml plate (lat bottom)	9,800.00
K	24×5ml (High cover)	12,500.00
L	12×15ml (High cover)	12,500.00
M	6×50ml (High cover)	12,500.00
N	Customized Block	12,500.00

UV Transilluminator



Specifications:

Model	Filter size (mm)	Wavelength (nm)	Intensity	Size(mm)	Price
CLS 10	200 x 200	302	Single Intensity	360 x 290 x 90	1,42,000.00

UV Transilluminator



Specifications:

Model	Filter size (mm)	Wavelength (nm)	Intensity	Size(mm)	Price
CLS 40A	260x210	302&365(254 option)	Variable Intensity	360x290x90	1,75,000.00

UV Transilluminator



Specifications:

MODEL	CLS-UV-365
UV source	365 nm Wave Length
Viewing area	24 x 14 cm
UV Tube	4x8 watts UV Tube
Housing	Anti Corrosion treated with Powder coated Mild Steel
UV Safety Shield	Clear Transparent lid for excellent clarity
Input	220V AC, 50-60HZ
Fuse	1 Amp
Price	40,000.00

UV Torch



Specifications:

MODEL	CLS-9403E
UV wavelength	254 nm and 365nm
Power of UV light	254 nm : 8W and 365nm : 8W
Light Transmittance	(230nm-400nm) 40%
Filter Size	180x 45 (mm)
Dimensions(LxBxH)	330 x 55 x 80 (mm)
Weight	0.5 kg
Price	28,000.00

UV Transilluminator



Specifications:

MODEL	CLS-BWL-01
UV Source	254/365nm wave Length
Viewing Area	20 X 20 cms
UV – Tubes	4 X 8 Watts UV Tube
Housing	Anti Corrosion treated with powder coated Mild Steel
UV Safety Shield	Clear Transparent lid for excellent clarity
Input Voltage	220VAC/50-60HZ
Fuse	2.5AMP
Price	88,000.00

Water Bath



Specifications:

MODEL	CLS-W420	CLS-W600
Working size	400x180x130 mm	580x280x130 mm
Power	1000W	1500W
Temperature range	RT+5 -100°C	RT+5 -100°C
Temp. Fluctuation	±1°C	±1°C
Temp. Homogeneity	±1°C	±1°C
Voltage	110V 60Hz /220V 50Hz	110V 60Hz /220V 50Hz
Dimension (mm)	480x260x280	660x360x280
Price	30,000.00	58,000.00

Variable Speed Vortex Mixer



Specifications:

MODEL	CLS-VSV
Speed range	250-2500rpm
Shaking movement	Orbital, 4mm dia
Motor type	Eccentric, oilless bearings
Power	60W
Motor rating output	10W
Dimensions	6"L x 6"W x 7"H
Weight	6 lbs
Voltage	110 Volts 60Hz
Price	16,000.00

Rocking Shaker



Specifications:

MODEL	CLS-RS-100
Speed	0-50 Oscill/min
Movement	See-Saw
Timer	0-60 min (optional)
Motor	PMDC Gear Motor
Platform size	250 X 250 mm
Overall dimension	260 mm (W) X 283 mm (D) X 180) mm
Price	32,000.00

Weighing Balance



Model	CLS-W-224
Capacity	220g
Readability	0.1 mg
Repeatability(+/-)	0.2mg
Linearity(+/-)	0.2 mg
Pan Size(Mm/Inch)	80Ø/3.5"Ø
Response Time	3 sec.
Display	Backlit LCD Display
Calibration	Single Key with external weights.
Units Of Measure	Milligram, Gram, Carat, Ounce Troy, Grain, Pennyweight, Momme, Hong Kong Tael, Singapore Tael, Taiwan Tael
Application Mode	Weighing, Animal/Dynamic Weighing, Parts Counting, Percent Weighing, Totalization
Operating Temperature	15°C to 35°C
Housing Dimension (W x d x h)	210 x 280 x 350 mm
Price	78,000.00

Weighing Balance



Model	CLS-W-203
Capacity	200g
Readability	0.001g
Repeatability(+/-)	0.002g
Linearity(+/-)	0.002g
Pan Size(Mm)	80 Ø
Response Time	< 3 sec.
Display	Backlit LCD Display
Calibration	Single Key with external weights.
Units Of Measure	gm, ct, lb, oz
Application Mode	Weighing, Parts Counting
Operating Temperature	15°C to 35°C
Housing Dimension(Wxdxh)	270 x 190 x 265 mm
Weigh Approx	4.5kg
Power Supply	External Adapter, 100-120VAC 150mA, 220-240VAC 100mA,
Price	32,000.00

**Multiparameter
pH/Conductivity/Salinity/TDS**



Specifications:

MODEL	CLS-MP30
pH Range	-2.000~20.000PH
pH Resolution	0.001, 0.01, 0.1 pH , Selectable
pH Accuracy	0.002pH
Calibration Points	Up to 5 points
ORP (mV) Range / Calibration	0 to ±1999.9mV/1 point
Ph Bufer Groups	USA, (pH1.68/4.01/7.00/10.01/12.45), NIST (pH1.68/4.01/6.86/9.18/12.45), DIN (pH1.09/4.65/6.79/9.23/12.75)
Resolution	0.1/1mv, Selectable
Accuracy	0.2mV
Measuring Mode	Absolute mV or Relative Mv
Conductivity Range	0-200mS/cm
Resolution	0.01/0.1/1
Accuracy	0.5% Full Scale
Cell Constant	0.1 / 1 / 10 / User deined
Temperature Coe cient	0.0-10.0% per °C
Calibratrrion Points	up to 5 points
Calibration Solutions	10us/cm, 84uc/cm, 1413us/cm, 12.88mS/cm, 111.8mS/cm
Compensation Modes	Linear or Pure Water
TDS Range	0-10ppt(Max.200 ppt, Depending on factor setting)
Resolution	0.01/0.1/1
Accuracy	1% Full Scale
TDS Factor	0 ~1.0
Salinity Range	0-80ppt
Resolution	0.01/0.1/1
Accuracy	1% Full Scale
Measurement Mode	Practical Salinity (PSU) or Seawater Measurement Standard (ppt)
Resistivity Range	0~100 Ω
Resolution	1/0.1/0.01
Accuracy	1% Full Scale
Temp. Range	0-105°C/32°C 221°F
Price	48,000.00

pH Meter



Speciications:

MODEL	CLS-PH-25CW
pH Range	0.00 to 14.00pH
pH Resolution	(+/-) 0.01pH
pH Accuracy	(+/-) 0.01pH
mV Range	(+) 1999mV
Temperature Range	0o to 100oC
Temperature Accuracy	(+) 1oC
Calibration Points	2 Points
Power Supply	DC 9V adaptors using AC220V/50Hz
Price	26,000.00

Edge pH Meter



Speciications:

MODEL	CLS2022
pH Range	-2.000 to 16.000 pH (Standard Mode), -2.00 to 16.00 pH (Basic Mode)
pH Resolution	0.001 pH, 0.01 pH
pH Accuracy (@25°C/77°F)	±0.01 pH, ±0.002 pH
pH Temperature Compensation	ATC: -5.0 to 100.0°C; 23.0 to 212.0°F*
mV Range	±1000.0 mV; ±2000.0 mV
mV Resolution	0.1 mV
mV Accuracy	±0.2 mV (±999.9 mV); ±1 mV (±2000 mV)
Relative mV Calibration	Single point calibration
Price	56,000.00

Magnetic Stirrer With Hot Plate



Specifications:

MODEL	CLS-H280PRO
Dimension of work plate [mm]	φ135 (5inch)
Work plate material	Stainless steel with ceramic coated hotplate
Motor type	DC motor
Motor rating input [W]	5
Motor rating output [W]	3
Power [W]	515
Voltage [VAC]	100 – 120/ 200 - 240
Frequency [Hz]	50/60
Stirring positions	1
Max. stirring quantity[H ₂ O]	3
Max. magnetic bar(L x Ø) [mm]	50
Speed range [rpm]	100-1500
Speed display	LED
Heating output [W]	500
Heating temperature range [°C]	RT – 280, equipment 1
Safety temperature [°C]	320
Temperature display	LED
Protection class according to DIN EN60529	IP21
Dimension [W x D x H] mm	150 x 260 x 80 mm
Weight [kg]	1.8
Permissible ambient temperature [°C]	5-40
Permissible relative humidity	80%
Price	30,000.00

PCR Machine



Specifications:

MODEL	CLS-W-160
Capacity	25×0.2mL(A);9×0.5mL(B);16×0.2mL+9×0.5mL(C)
Temp range	0 °C–99.9 °C(Rt≤30°C)
Max heating rate	≥2 °C/s
Max cooling rate	≥2 °C/s
Uniformity	≤±0.3°C (Constant 10s)
Accuracy	≤±0.2 °C
Temp control	Block
Stored program No.	3
Max. No. of Cycle	99
Display	12864 LCD
Communication	Serial Port
Size	160 mm (L) x 140 mm (W) x 120 mm (H)
Weight	2.2 kg
Price	1,52,000.00

Ice Flaking Machine



Specifications:

MODEL	CLS-F-20
Capacity	20 Kg/24 Hr
Ice Storage	10 Kg
Voltage	220V/50Hz or 110V/60Hz
Power	280 W
Cooling Type	Air Cooling
Refrigerant	R134a
Price	1,33,000.00

Ice Making Machine



Specifications:

Model	CLS-M-20
Production Capacity	20kg/24h
Storage Capacity	5kg
Refrigerant	R134a/110g
Body Material	304/2B Stainless Steel
Water Quality Requirement	Potable Water
Inlet Pressure	>0.15-0.3MPa
Inlet Pipe Diameter	0.75inch
Pipeline Material	Food Grade Plastic
Ice Quality	Food Grade
Price	1,50,000.00

Vertical Autoclave

Reliable autoclave for all applications requiring, total destruction of all living micro-organisms, in laboratories, hospitals, nursing homes, R&D labs etc. It is used to sterilize equipment by subjecting them to high pressure saturated steam at 121° C for around 15-20 minutes

- The outer chamber is made of heavy gauge stainless steel sheet duly polished
- The inner is made of thick 304 grade stainless steel sheet
- Lid is made of thick machined high grade stainless steel plate
- The unit has wing Nut type locking arrangement
- Unit is provided with spring loaded safety valve ,pressure gauge ,pressure Release valve,water level indicator & Drain valve
- Unit is hydraulically tested to with stand up to 40 psi pressure
- All internal joints are argon arc welded, ground and polished to give crevice free internals
- Molded joint –less silicon Rubber gasket is provided for leak proofing
- The unit is electrically heated by Lange type/immersion type heaters
- Supplied with control Box, fitted with mains & heating indicators, Rockers switch ,cord & plug to work on 220/230V,50HZ AC supply.



Specifications:

Model	Size	Price
CLSA22	250 x 450 mm, 22 Ltr.	50000.00
CLSA50	350 x 550 mm, 50 Ltr.	95000.00
CLSA75	400 x 600 mm, 75Ltr.	120000.00

Ultrasonic Cleaner



Specifications:

Models	Tank Capacity	Ultrasonic Wattage	Heating	Price
CLS-1.8L	1.8L	50W	Ambient to 80°C Digitally Controlled	19,000.00
CLS-2.5L	2.5L	50W	Ambient to 80°C Digitally Controlled	21,000.00
CLS-4L	4L	100W	Ambient to 80°C Digitally Controlled	42,000.00
CLS-6L	6L	150W	Ambient to 80°C Digitally Controlled	62,000.00
CLS-9L	9L	200W	Ambient to 80°C Digitally Controlled	80,000.00
CLS-25L	25L	600W	Ambient to 80°C Digitally Controlled	1,40,000.00

Ultrasonic Homogenizer

Features:

- Digital display, Fully microprocessor controlled and completely programmable
- Auto-tuning for convenience of use and optimal processing efficiency
- Variable power output, upto 650 watts
- Integrated Sound Abating Chamber to reduce cavitation sound emitted during processing



Specifications:

Model	CLS-92
Power Rating:	650W
Output Frequency:	20-25KHz
Sample volume:	05-500mL
Accompany (Ø)	Ø6
Optional Titanium Horn:	Ø2,3,10,12,15
Dimensions	534 X 295 X 435 mm
Weight:	14kg
Duty Ratio (%)	1-99%
Price	3,85,000.00

Ultrasonic Homogenizer

Features:

- Digital display, Fully microprocessor controlled and completely programmable
- Auto-tuning for convenience of use and optimal processing efficiency
- Variable power output, 0-150 watts
- Integrated Sound Abating Chamber to reduce cavitation sound emitted during processing



Specifications:

Model	CLS-96
Power Rating:	150W
Output Frequency:	20-25KHz
Sample volume:	10-100mL
Standard Titanium Horn:	Ø6 (10-100ml)
Optional Titanium Horn:	Ø3 (3-10ml), Ø2 (0.5-3ml)
Dimensions	534 X 295 X 435 mm
Weight:	9.3 kg
Duty Ratio	1-99%
Price	2,95,000.00

Pipettes

TopPette Mechanical Pipettes

Non Autoclavable

- Lightweight, ergonomic, low force design
- Digital display clearly reads volume setting
- The pipettes cover volume range of 0.1µl to 10ml
- Easy to calibrate and maintain with tool supplied
- Design helps avoid repetitive strain injuries
- Calibrated in accordance with ISO8655. Each pipette supplied with individual test certificate



Single-Channel Adjustable Volume Pipette

TopPette Mechanical Pipettes

Cat No	Volume Range	Price
CLS-17571	0.1-2.5µl	5562.00
CLS-17572	0.5-10µl	5562.00
CLS-17573	5-50µl	5562.00
CLS-17574	2-20µl	5562.00
CLS-17575	10-100µl	5562.00
CLS-17576	20-200µl	5562.00
CLS-17577	50-200µl	5562.00
CLS-17578	100-1000µl	5562.00
CLS-17579	200-1000µl	5562.00
CLS-17580	1000-5000µl	5562.00
CLS-17581	2-10ml	5562.00

MicroPette Mechanical Pipettes

Semi Autoclavable

- Lightweight, ergonomic, low force design
- Digital display clearly reads volume setting
- The pipettes cover volume range of 0.1µl to 10ml
- Easy to calibrate and maintain with tool supplied
- Design helps avoid repetitive strain injuries
- Calibrated in accordance with ISO8655. Each pipette supplied with individual test certificate
- The low part is available for autoclaving
- Manufactured from innovative materials



Single-Channel Adjustable Volume Pipette

MicroPette Mechanical Pipettes

Cat No	Volume Range	Price
CLS-17596	0.1-2.5µl	6197.00
CLS-17597	0.5-10µl	6197.00
CLS-17598	2-20µl	6197.00
CLS-17599	5-50µl	6197.00
CLS-17600	10-100µl	6197.00
CLS-17601	20-200µl	6197.00
CLS-17602	50-200µl	6197.00
CLS-17603	100-1000µl	6197.00
CLS-17604	200-1000µl	6197.00
CLS-17605	1000-5000µl	6197.00
CLS-17606	2-10ml	6197.00

MicroPette Plus Autoclavable Pipette

Fully Autoclavable

- Lightweight, ergonomic, low force design
- Digital display clearly reads volume setting
- The pipettes cover volume range of 0.1µl to 10ml
- Easy to calibrate and maintain with tool supplied
- Design helps avoid repetitive strain injuries
- Manufactured from innovative material
- Calibrated in accordance with ISO8655. Each pipette supplied with individual test certificate



Single-Channel Adjustable Volume Pipette

MicroPette Plus Autoclavable Pipette

Cat No	Volume Range	Price
CLS-17582	0.1-2.5µl	6833.00
CLS-17583	0.5-10µl	6833.00
CLS-17584	2-20µl	6833.00
CLS-17585	5-50µl	6833.00
CLS-17586	10-100µl	6833.00
CLS-17587	20-200µl	6833.00
CLS-17588	50-200µl	6833.00
CLS-17589	100-1000µl	6833.00
CLS-17590	200-1000µl	6833.00
CLS-17591	1000-5000µl	6833.00
CLS-17592	2-10ml	6833.00

8-Channel TopPette

Non Autoclavable

- 8 channel pipettes are available for standard 96-well plate
- Dispensing head rotates for optimum pipetting convenience
- Individual piston and tip cone assemblies allow easy repair and maintenance
- Compound material tip cone design allows visual seal verification
- Can be used with universal style pipette tips



Adjustable Volume Pipette

TopPette Mechanical Pipettes

Cat No	Volume Range	Price
CLS-17593	0.5-10µl	25424.00
CLS-17594	5-50µl	25424.00
CLS-17595	50-300µl	25424.00

8-Channel MicroPette

Semi Autoclavable

- 8 channel pipettes are available for standard 96-well plate
- Dispensing head rotates for optimum pipetting convenience
- Individual piston and tip cone assemblies allow easy repair and maintenance
- Compound material tip cone design allows visual seal verification
- Can be used with universal style pipette tips



Adjustable Volume Pipette

MicroPette Mechanical Pipettes

Cat No	Volume Range	Price
CLS-17607	0.5-10µl	27013.00
CLS-17608	5-50µl	27013.00
CLS-17609	50-300µl	27013.00

8-Channel MicroPette Plus

Fully Autoclavable

- 8 channel pipettes are available for standard 96-well plate
- Dispensing head rotates for optimum pipetting convenience
- Individual piston and tip cone assemblies allow easy repair and maintenance
- Compound material tip cone design allows visual seal verification
- Can be used with universal style pipette tips



Adjustable Volume Pipette

MicroPette Plus Autoclavable Pipette

Cat No	Volume Range	Price
CLS-17610	0.5-10µl	28602.00
CLS-17611	5-50µl	28602.00
CLS-17612	50-300µl	28602.00

12-Channel TopPette

Non Autoclavable

- 12 channel pipettes are available for standard 96-well plate
- Dispensing head rotates for optimum pipetting convenience
- Individual piston and tip cone assemblies allow easy repair and maintenance
- Compound material tip cone design allows visual seal verification
- Can be used with universal style pipette tips



Adjustable Volume Pipette

TopPette Mechanical Pipettes

Cat No	Volume Range	Price
CLS-17617	0.5-10µl	27013.00
CLS-17618	5-50µl	27013.00
CLS-17619	50-300µl	27013.00

12-Channel MicroPette

Semi Autoclavable

- 12 channel pipettes are available for standard 96-well plate
- Dispensing head rotates for optimum pipetting convenience
- Individual piston and tip cone assemblies allow easy repair and maintenance
- Compound material tip cone design allows visual seal verification
- Can be used with universal style pipette tips



Adjustable Volume Pipette

MicroPette Mechanical Pipettes

Cat No	Volume Range	Price (₹)
CLS-17621	0.5-10µl	28602.00
CLS-17622	5-50µl	28602.00
CLS-17623	50-300µl	28602.00

12-Channel MicroPette Plus

Fully Autoclavable

- 12 channel pipettes are available for standard 96-well plate
- Dispensing head rotates for optimum pipetting convenience
- Individual piston and tip cone assemblies allow easy repair and maintenance
- Compound material tip cone design allows visual seal verification
- Can be used with universal style pipette tips



Adjustable Volume Pipette

MicroPette Plus Autoclavable Pipette

Cat No	Volume Range	Price
CLS-17613	0.5-10µl	30191.00
CLS-17614	5-50µl	30191.00
CLS-17615	50-300µl	30191.00

Round Pipette Stand

The round stands have been designed to it perfectly of Pipette range, TopPette, MicroPette and MicroPette Plus Autoclavable Pipettes. The stands are convenient to hold up 6 pipettes both of single and multi-channel.

Cat No	Product	Price (₹)
CLS-17616	Round stand holds up to 6 pipettes, it of TopPette, MicroPette and MicroPette Plus	8800.00



Linear Pipette Stand

The linear have been designed to it perfectly of Pipette range, TopPette, MicroPette and MicroPette Plus Autoclavable Pipettes. The stands are convenient to hold up 6 pipettes both of single and multi-channel.

Cat No	Product	Price (₹)
CLS-17620	Linear stand holds up to 6 pipettes, it of TopPette, MicroPette and MicroPette Plus	8200.00



Single Channel Adjustable Electronic Pipette

Description:-

- A motor drive digital control pipette with multifunction Pipetting, Mixing, Stepper and Dilution
- 2 buttons handle all operation and setting
- A wide range of pipetting modules for selection
- Adjustable speeds for aspiration and dispensing
- Li-ion battery and two charging mode enable longer operation time
- Self calibration – By link it to a PC and a balance with USB connector.



Cat No	Volume Range	Increment	Price (₹)
CLS-17624	0.5-10uL	0.01uL	45000.00
CLS-17625	5-50uL	0.1uL	45000.00
CLS-17626	30-300uL	1uL	45000.00
CLS-17627	100-1000uL	5uL	45000.00

Levo Plus Motorized Pipette Filter

- Full volume range of 0.1-100ml
- Easy to one-handed operation
- Lightweight, ergonomic designs allow longer, fatigue-free pipetting
- Efficient lithium-ion battery offers long runtime on each charge
- Low battery alert
- Powerful motor fills a 25ml pipette in <5 seconds
- Supplied with integral but replaceable 0.45um filter
- Can be used while charging
- Large LCD display provides visual confirmation of remaining battery charge and speed settings
- Eight speeds are available for aspirate and dispense liquid



Large LCD display provides visual confirmation of remaining battery charge and coarse speed settings

Select the desired speed by turning the speed adjustment wheel

Silicone adapter suitable for 0.1-100ml pipette, can be fully autoclaved at 121°C

Cat No	Product	Price
CLS-17628	Levo Plus with AC adapter spare 0.45µm filter and wall stand, Euro plug	19,500.00

Purple Nitrile Powder-Free Gloves

Description

- Nitrile, synthetic rubber construction eliminates the possibility of latex-oriented allergic reactions
- Long, 9.5" ambidextrous design
- Get a good grip and an excellent fit
- Textured fingertips allow you to work with ease and confidence
- Easy-to-don beaded cuffs provide greater strength and durability
- Non-sterile for medical use



Cat No	Product	Pack Size	Price
CLS-PS	Purple nitrile Powder free Gloves, Small	100/pk 10pk/Case	850.00 7910.00
CLS-PM	Purple nitrile Powder free Gloves, Medium	100/pk 10pk/Case	850.00 7910.00
CLS-PL	Purple nitrile Powder free Gloves, Large	100/pk 10pk/Case	850.00 7910.00

Nitrile Gloves Powder Free

An economical option with the full benefits of nitrile, this version comes in a thinner format which fits and feels like latex. Nitrile is resistant to a wide range of chemicals, and offers excellent tear strength and puncture resistance. Textured fingertips provide good grip in wet or dry applications. Latex free, ergonomic design for reduced hand fatigue.



Cat No	Product	Pack Size	Price
CLS-NS	Nitrile Powder free Gloves, Small	100/pk 10pk/Case	725.00 6887.00
CLS-NM	Nitrile Powder free Gloves, Medium	100/pk 10pk/Case	725.00 6887.00
CLS-NL	Nitrile Powder free Gloves, Large	100/pk 10pk/Case	725.00 6887.00

Latex Examination Powder Free Gloves

The feel and fit of all-natural rubber latex is a powder free alternative. Featuring low protein content, leaving your hands soft and comfortable. Ergonomic design for reduced hand fatigue and stiffness. Easily donned and removed. Fully textured surface allowing for superior grip control, tactile sensitivity and manual dexterity. Natural rubber latex for superior protection.



Cat No	Product	Pack Size	Price
CLS-LS	Latex Examination Powder free Gloves, Small	100/pk 10pk/Case	710.00 6745.00
CLS-LM	Latex Examination Powder free Gloves, Medium	100/pk 10pk/Case	710.00 6745.00
CLS-LL	Latex Examination Powder free Gloves, Large	100/pk 10pk/Case	710.00 6745.00

High Temperature Gloves

Para-aramid based fabric is a remarkable fiber that provides strength to protect under extreme conditions. These gloves are substitute for asbestos gloves and most suitable for handling high temperature items. Gloves provide excellent hand protection without sacrificing manual dexterity or comfort and offering exceptional resistance to cut, slash and tear. Gloves made of fabric do not burn and will not melt and is most suitable substitute of asbestos gloves. Gloves are most suitable against open flame and hot metal splashes and can withstand temperature up to 350oC and with heavy woolen insulation up to 550oC.



Cat No	Product	Pk Size	Price
CLS018	High Temperature Gloves	1 Pair	4000.00

Cryo Gloves

Cryo-Gloves are multi layer insulated gloves designed to provide protection to the hands and arms from the hazard encountered when working with ultra cold. They are light weight, flexible, durable, clean, allow for excellent dexterity, are very comfortable wear for extended periods and are extremely warm.



Cat No	Product	Pk Size	Price
CLS Cyro S	Cryo Gloves Small	1 Pair	18020.00
CLS Cyro M	Cryo Gloves Medium	1 Pair	18020.00
CLS Cyro L	Cryo Gloves Large	1 Pair	18020.00

Parafilm

We are among the distinguished names in the industry, engaged in offering Parafilm Tape to our valuable customers. The offered parafilm tapes are manufactured as per the prevailing industry standards and are known for their moisture holding capacity. These parafilms are precise in terms of dimensions and are made available at competitive prices



Cat No	Film Width	Roll Length	w x h x d, mm	Price
CLS-502A	50 mm (2-inch)	75 m	135 x 58 x 132	3500.00
CLS-1004A	100 mm (4-inch)	38 m	132 x 135 x 112	4500.00

Sealing Film

The Sealing Film was developed with the assistance of a major cycler manufacturer for PCR applications. Not only does it offer low-auto fluorescence but it will prevent vapor loss and is thermostable and functional from -70 °C to +95°C. Certified RNase, DNase and DNA-free. DMSO resistant. This transparent sealing tape consists of a 2.0 mil polyolefin film coated on one side with a pressure sensitive acrylate adhesive which does not interfere with cycle reactions.

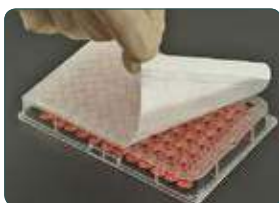

Cat No	Product	Pk Size	Price
CLS-418	Sealing Film, 50 Sheets	1PK	3510.00
CLS-418-S	Sealing Film, Sterile, 50 Sheets	1PK	3780.00

96-Well PCR Plate

96 Well PCR Plates are non-skirted for optimal flexibility. The raised rim of each well ensures a reduced risk of cross contamination and more effective adhesive film sealing to ensure samples (up to 200µl) remain intact. These PCR Plates are suitable for thermal cyclers and because of the high quality polypropylene material, PCR and qPCR applications can be conducted with confidence.



Specifications

- Non-skirted for optimal flexibility
- Reduced risks of cross contamination
- Improved adhesive film sealing
- High quality polypropylene

Cat No	Product	Pk Size	Price
CLS034	96-Well PCR Plate 5 plates/pk	5 plates/pk	1890.00

Autoclave Indicator Tap

Description

The Autoclave indicator Tape consists of an adhesive, backing and chemical indicator strips. The adhesive is an aggressive, pressure-sensitive designed to adhere to a variety of wraps, including woven, treated woven, non-woven, paper and paper/plastic wraps in order to secure the pack during steam sterilization. After sterilization, the tape is designed to remove easily and cleanly from treated and untreated woven wraps. The backing is a saturated crepe paper and provides the stretch needed for pack expansion during sterilization. The chemical indicator lines will turn dark-brown/black on beige background when exposed at a steam sterilization process.



Cat No	Product	Pk Size	Price
CLS011	Autoclave Indicator Tape	1 ROLLS	5400.00

Inoculating Loops & L Shaped Spreader

The inoculating loops are made of PS material offers high flexibility provide comfortable, stable and uniform streaking without damage to nutrient surface. The pre-Sterile L Shaped spreaders are ideal for spreading of samples on agar surfaces without disturbing media layer. It has smooth rounded surface to prevent any cutting or gouging of agar inoculation of culture plates. L Shape enables even spreading

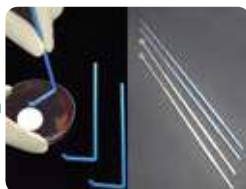

Cat No	Capacity	Pack	Price
CLS10001	1ul Sterile Loop	10/Pk, 100/Case	464.00
CLS10001-1	1ul Sterile Loop	1/Pk, 100/Case	600.00
CLS10010	10ul Sterile Loop	10/Pk, 100/Case	464.00
CLS10010-1	10ul Sterile Loop	1/Pk, 100/Case	600.00
CLS10000	L Shaped Spreader-Sterile	10/Pk. 100/Pack	1280.00

Autoclave Bag

- Allow for repeated autoclaving
- Strong side seams for security holding items
- Thickness: 2.0 mil thick polypropylen
- Temperature: 121 °C (250 °F)



Cat No	Size	Pack	Price
CLS/AB/1225	310 x 660 mm	500/Pack	15333.00
CLS/AB/1625	415 x 600 mm	500/Pack	18333.00
CLS/AB/2432	610 x 810 mm	500/Pack	21333.00

Bio Hazard Bag

A range of biohazard collection bag printed with biohazard warning symbol.



Cat No	Size	Color	Pack	Price
CLS/1224WR	12 x 24 inches	White (Red Print)	500/Pack	14500.00
CLS/2436	24 x 36 inches	Red	500/Pack	21200.00
CLS/1624Y	16 x 24 inches	Yellow	500/Pack	19300.00

Petri Dish

- Used by microbiologists to culture Micro-organism on solid media
- Non vented dishes have lid which fits flatly on the base resulting in less potential for external contamination and significantly reduced evaporation rate.



Cat No	Product	Pk Size	Price
CLS-P-90	Petri Dish, Disposable, 90mm Single Room, Sterile, Individual Pack	500/pk	5200.00

Protective Eyewear

These products are intended for protection against high speed particles at low energy (F) at extreme temperature conditions, -5 °C and +55°C (T) in accordance with EN166:2001. They also protect against UV radiation in accordance with EN170:2002.



- This protective eyewear has been shown to meet the basic safety requirements under Article 10 of the European Community Directive 89/686/EEC and is thus CE marked.
- These products have been examined at the design stage by INSPEC International Ltd., 56 Leslie Hough way, Salford, Greater Manchester, M6 6AJ,

Cat No	Description	Pack Size	Price
CLS1709	Protective Eyewear	1/pk	700.00

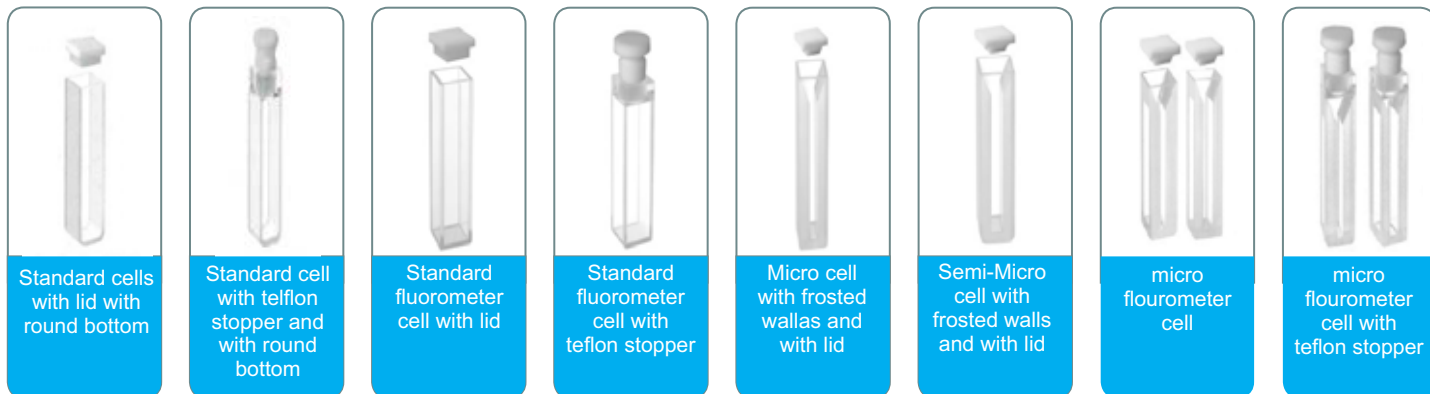
Cuvette

* Q=Quartz G=Optical Glas

Specifications - Standard cells with lid with round bottom(2/PK)

Outside Dim HxWxD mm	Path Lenght mm	Inside Width mm	Volume ml	ES Qyarz Glass 190nm-2500nm	Product Number		
					Price	Optical Glass 340nm-2500nm	Price
45×12.5×3.5	1	10	0.35	CQ-101	15050.00	CG-101	4610.00
45×12.5×4.5	2	10	0.7	CQ-102	12875.00	CG-102	4175.00
45×12.5×7.5	5	10	1.7	CQ-103	7220.00	CG-103	2653.00
45×12.5×12.5	10	10	3.5	CQ-104	5480.00	CG-104	2653.00
45×12.5×22.5	20	10	7	CQ-105	12875.00	CG-105	3610.00
45×12.5×32.5	30	10	10.5	CQ-106	15050.00	CG-106	3697.00
45×12.5×42.5	40	10	14	CQ-107	17225.00	CG-107	3740.00
45×12.5×52.5	50	10	17.5	CQ-108	17225.00	CG-108	3740.00
45×12.5×102.5	100	10	35	CQ-109	30275.00	CG-109	7220.00

Specifications - Standard cell with teflon stopper and with round bottom(2/PK)

45x 12.5x 12.5	10	10	3.5	CQ-114	15050.00	CG-114	6350.00
----------------	----	----	-----	--------	----------	--------	---------

Specifications - Standard fluorometer cell with lid(2/PK)

45x 12.5x 12.5	10	10	3.5	CQ-204	15050.00	CG-204	6350.00
----------------	----	----	-----	--------	----------	--------	---------

Specifications - Standard fluorometer cell with lid(2/PK)

45x 12.5x 12.5	10	10	3.5	CQ-214	17225.00	CG-214	8525.00
----------------	----	----	-----	--------	----------	--------	---------

Specifications - Semi-Micro cell with frosted walls and with lid(2/PK)

45x 12.5x 12.5	10	1	0.35	CQ-234	10700.00	CG-234	8525.00
45x 12.5x 12.5	10	2	0.7	CQ-244	10700.00	CG-244	8525.00
45x 12.5x 12.5	10	3	1	CQ-254	10700.00	CG-254	8525.00

Specifications - Micro cell with frosted walls and with lid(2/PK)

45x 12.5x 12.5	10	4	1.4	CQ-264	10700.00	CG-264	8525.00
45x 12.5x 12.5	10	5	1.7	CQ-274	10700.00	CG-274	8525.00

Specifications - Micro fluourometer cell(2/PK)

45x 12.5x 12.5	10	1	0.35	CQ-504	23750.00	CG-504	19400.00
45x 12.5x 12.5	10	2	0.7	CQ-514	23750.00	CG-514	19400.00
45x 12.5x 12.5	10	3	1	CQ-524	23750.00	CG-524	19400.00
45x 12.5x 12.5	10	4	1.4	CQ-534	23750.00	CG-534	19400.00

Specifications - Micro fluourometer cell(2/PK)

45x 12.5x 12.5	10	1	0.35	CQ-554	25490.00	CG-554	21575.00
45x 12.5x 12.5	10	2	0.7	CQ-564	25490.00	CG-564	21575.00
45x 12.5x 12.5	10	3	1	CQ-574	25490.00	CG-574	21575.00
45x 12.5x 12.5	10	4	1.4	CQ-584	25490.00	CG-584	21575.00

Micro Pipette Tips

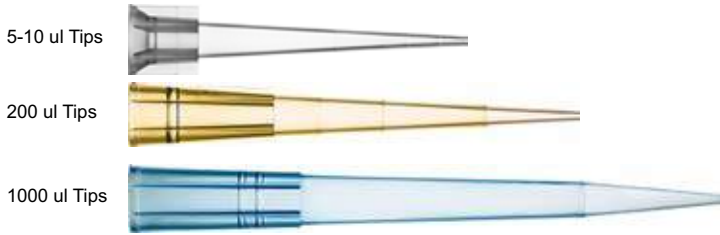

Cat No	Product	Pack	Price
C10MT	Micro Tips 5-10 ul, polypropylene,	1000/pk 20pk/Case	950.00 12240.00
C200MT	Pipette Tips 200 ul, polypropylene, autoclavable	1000/pk 20pk/Case	720.00 8840.00
C1000MT	Pipette Tips 1000 ul, polypropylene, autoclavable	1000/pk 20pk/Case	1500.00 21760.00

Filter Tips

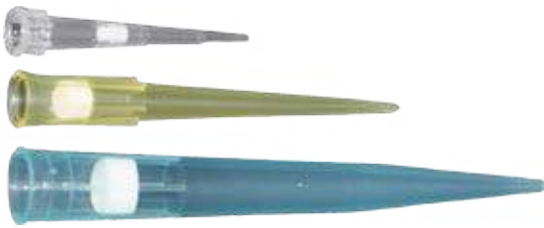

Filter tips are especially suited for working with PCR. Filter tips are produced from High quality colour Less granules. of Virgin ploypropylene to minimize liquid retention ensure most accurate and consistent result. The hydrophobic filter maximize tip performance and prevents particles to reach pipettor. (96/Rack)

Cat No	Product	Pack Size	Price
CLS12010-R	10 ul with Filter Low Retention, Sterilized, Rack Pack	20 Rack/Pack	19375.00
CLS12200-R	200 ul with Filter Low Retention, Sterilized, Rack Pack	20 Rack/Pack	19375.00
CLS12000-R	1000 ul with Filter Low Retention, Sterilized, Rack Pack	20 Rack/Pack	22475.00

Centrifuge Tubes Standards

Standard quality Centrifuge tubes are made from highquality polypropylene assures good transparency and chemical resistibility. The bold white color graduations and writing areas are clear and are chloroform resistant. These tubes are leak proof and can be autoclaved to 121 °C /Freezable to -80 °C.



Cat No	Product	Pack Size	Price
CLS0015	15 ml	500/Box, 1000 Pack	10370.00
CLS0050	50 ml	500/Pack	8415.00
CLS1015	15 ml Sterilized	500/Box, 1000/Pack	12665.00
CLS1050	50 ml Sterilized	500/Pack	9520.00

PCR And Micro Centrifuge Tubes

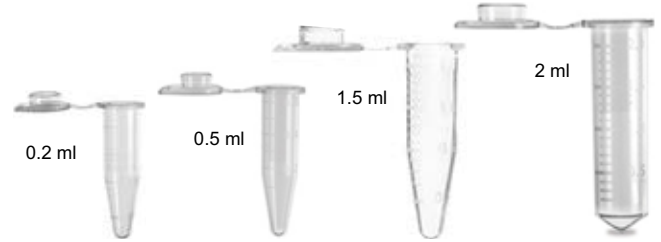

Cat No	Product	Pack	Price
C200LT	0.2ml PCR Tube, Polypropylene Clear, Graduated, Conical Bottom	1000/pk, 20pk/Case	4400.00 79200.00
C500LT	0.5ml Tube, Polypropylene Clear, Graduated, Conical Bottom	1000/pk, 20pk/Case	2500.00 31500.00
C1.5MCT	1.5ml CentrifugeTube, Polypropylene Clear, Graduated, Conical Bottom, Flat Cap.	1000/pk, 20pk/Case	1500.00 23500.00
C2MCT	2ml CentrifugeTube, Polypropylene Clear, Graduated, Conical Bottom, Flat Cap	1000/pk, 20pk/Case	1800.00 27500.00

Centrifuge Tubes Premium

Centrifuge tubes Personal quality are made from medical grads superior 100% virgin polypropylene assures good transparency chemical resistibility and havelow retension surface. Thus tubes are available either Sterilized or Non Sterilizez in order to satisfy the diffrent research requirements. The Bold Black graduation and writing area are clear and are chloroform resistant. These tubes are Leakproof can be autoclaved to 121 °C /Freezable to -80 °C.



Cat No	Capacity	Pack Size	Price
CLS00015	15 ml	50/Bag, 500/Box, 1000/Pack	15215.00
CLS00050	50 ml	50/Bag, 500/Pack	10200.00
CLS10015	15 ml Sterilized	25/Bag, 500/Box, 1000/Pack	18700.00
CLS10050	50 ml Sterilized	25/Bag, 500/Pack	12325.00

Pipette Tips Box

PP withstand Autocalving and Freezing



Cat No	Product	Pack Size	Price
CLS0010	10 ul	4	1600.00
CLS0200	200 ul	4	1600.00
CLS1000	1000 ul	4	1840.00

Pasteur Pipettes

Pasteur are made of PE-LD and are perfect products for transfer of fluids in a quick and safe way.



Cat No	Capacity	Pack	Price
CLS00001	1 mL, Non Sterile	500 Box, 10 Box/Pack	9520.00
CLS10001	1 mL, Sterile	100 Box, 10 Box/Pack	6320.00
CLS00003	3 mL, Non Sterile	500 Box, 10 Box/Pack	9420.00
CLS10003	3 mL, Sterile	100 Box, 10 Box/Pack	6320.00

Syringe Filters

Introduction

BRBLS Syringe Filters are simply quality filters, well packaged, and offered at a fair. The Classic range is available in all of the major membranes including Nylon, PES, MCE, PVDF, CA and GF which are supplied in 13mm, 17mm, 25mm and 30mm formats in virgin polypropylene housing.

Feature

- Application Compatibility: Broad range of filtration media meets diverse application needs
- Minimum sample hold-up: Syringe Filter's housings are specifically designed to maximize sample recovery
- Convenient: Each unit is clearly marked with an identifying code to denote pore size, membrane material

Application

- HPLC sample preparation
- Routine QC analysis
- Content uniformity
- Removal of protein precipitates
- Dissolution testing
- Food analysis
- Biofuel analysis
- Environmental samples

Syringe Filters Selection Guide

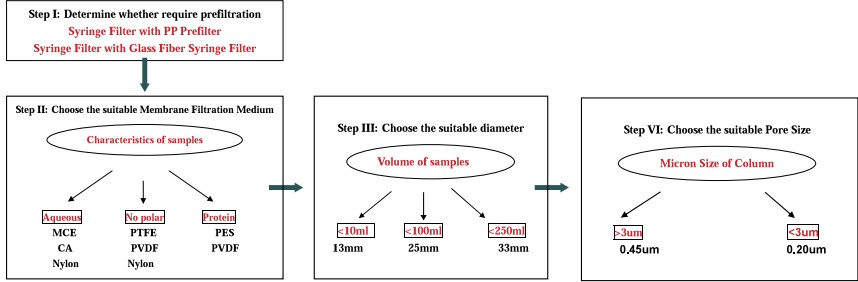

Syringe Filter (Non Sterile)

Cat No.	Dia(mm)	Pore Size (um)	Material	Package	Price
CLSF01	13	0.45	Nylon 66	100 Pcs/box	4140.00
CLSF02	13	0.22	Nylon 66	100 Pcs/box	4140.00
CLSF03	13	0.45	PES	100 Pcs/box	4140.00
CLSF04	13	0.22	PES	100 Pcs/box	4140.00
CLSF05	25	0.45	Nylon 6	100 Pcs/box	5865.00
CLSF06	25	0.22	Nylon 6	100 Pcs/box	5865.00
CLSF07	25	0.45	PES	100 Pcs/box	5865.00
CLSF08	25	0.22	PES	100 Pcs/box	5865.00
CLSF09	25	0.45	Nylon 66	100 Pcs/box	7935.00
CLSF10	25	0.22	Nylon 66	100 Pcs/box	7935.00
CLSF11	13	0.45	MCE	100 Pcs/box	2760.00
CLSF12	13	0.22	MCE	100 Pcs/box	2760.00
CLSF13	25	0.45	MCE	100 Pcs/box	4830.00
CLSF14	25	0.22	MCE	100 Pcs/box	4830.00
CLSF15	13	0.45	PTFE	100 Pcs/box	5520.00
CLSF16	13	0.22	PTFE	100 Pcs/box	5520.00
CLSF17	25	0.45	PTFE	100 Pcs/box	8280.00
CLSF18	25	0.22	PTFE	100 Pcs/box	8250.00
CLSF19	13	0.45	GHP	100 Pcs/box	15600.00
CLSF20	13	0.22	GHP	100 Pcs/box	15600.00
CLSF21	25	0.45	GHP	100 Pcs/box	33300.00
CLSF22	25	0.22	GHP	100 Pcs/box	33300.00
CLSF23	13	0.45	PVDF	100 Pcs/box	6210.00
CLSF24	13	0.22	PVDF	100 Pcs/box	6210.00
CLSF25	25	0.45	PVDF	100 Pcs/box	10350.00
CLSF26	25	0.22	PVDF	100 Pcs/box	10350.00



Syringe Filter Ordering information (sterile)

Nylon66 Syringe Filter (Polyamide-66, 13mm/25mm)

Cat No.	Product	Package	Price
CLSNY013022S	Sterile Nylon Syringe Filters, Pore:0.22(um), Housing Diameter:13(mm)	100	11400.00
CLSNY013045S	Sterile Nylon Syringe Filters, Pore:0.45(um), Housing Diameter:13(mm)	100	11400.00
CLSNY025022S	Sterile Nylon Syringe Filters, Pore:0.22(um), Housing Diameter:25(mm)	100	13200.00
CLSNY025045S	Sterile Nylon Syringe Filters, Pore:0.45(um), Housing Diameter:25(mm)	100	13200.00
CLSNY030022S	Sterile Nylon Syringe Filters, Pore:0.22(um), Housing Diameter:30(mm)	100	15000.00
CLSNY030045S	Sterile Nylon Syringe Filters, Pore:0.45(um), Housing Diameter:30(mm)	100	15000.00



PES Syringe Filter (Polyethersulfone)

Cat No.	Product	Package	Price (₹)
CLSPES013022S	Sterile PES Syringe Filters, Pore:0.22(µm), Housing Diameter:13(mm)	100	10800.00
CLSPES013045S	Sterile PES Syringe Filters, Pore:0.45(µm), Housing Diameter:13(mm)	100	10800.00
CLSPES025022S	Sterile PES Syringe Filters, Pore:0.22(µm), Housing Diameter:25(mm)	100	12600.00
CLSPES025045S	Sterile PES Syringe Filters, Pore:0.45(µm), Housing Diameter:25(mm)	100	12600.00
CLSPES030022S	Sterile PES Syringe Filters, Pore:0.22(µm), Housing Diameter:30(mm)	100	14400.00
CLSPES030045S	Sterile PES Syringe Filters, Pore:0.45(µm), Housing Diameter:30(mm)	100	14400.00



Syringe Filter (Cellulose Acetate)

Cat No.	Product	Package	Price (₹)
CLSCA013022S	Sterile CA Syringe Filters, Pore:0.22(µm), Housing Diameter:13(mm)	100	10800.00
CLSCA013045S	Sterile CA Syringe Filters, Pore:0.45(µm), Housing Diameter:13(mm)	100	10800.00
CLSCA025022S	Sterile CA Syringe Filters, Pore:0.22(µm), Housing Diameter:25(mm)	100	12600.00
CLSCA025045S	Sterile CA Syringe Filters, Pore:0.45(µm), Housing Diameter:25(mm)	100	12600.00
CLSCA030022S	Sterile CA Syringe Filters, Pore:0.22(µm), Housing Diameter:30(mm)	100	14400.00
CLSCA030045S	Sterile CA Syringe Filters, Pore:0.45(µm), Housing Diameter:30(mm)	100	14400.00



Syringe Filter (Polyvinylidene Fluoride)

Cat No.	Product	Package	Price (₹)
CLSPF013022S	Sterile Hydrophobic PVDF Syringe Filters, Pore:0.22(µm), Housing Diameter:13(mm)	100	11400.00
CLSPF013045S	Sterile Hydrophobic PVDF Syringe Filters, Pore:0.45(µm), Housing Diameter:13(mm)	100	11400.00
CLSPF025022S	Sterile Hydrophobic PVDF Syringe Filters, Pore:0.22(µm), Housing Diameter:25(mm)	100	13200.00
CLSPF025045S	Sterile Hydrophobic PVDF Syringe Filters, Pore:0.45(µm), Housing Diameter:25(mm)	100	13200.00
CLSPF030022S	Sterile Hydrophobic PVDF Syringe Filters, Pore:0.22(µm), Housing Diameter:30(mm)	100	15000.00
CLSPF030045S	Sterile Hydrophobic PVDF Syringe Filters, Pore:0.45(µm), Housing Diameter:30(mm)	100	15000.00



Membrane Filter

Membrane filters or “membranes” are microporous films with specific pore size ratings. Membranes retain particles and microorganisms that exceed their pore ratings by acting as a physical barrier and capturing such particles on the surface of the membrane.

Application

- General clean and filtration
- Sample Prep
- Environmental Monitoring and Analysis
- Filtration of Aqueous and Organic Solutions
- Fluid Monitoring
- Pharmaceutical Products Analysis
- Chromatography and Mass Spec Sample Prep
- Venting and Gas Filtration

Feature

- High Porosity: BRBLS™ thin membrane with high porosity provide high liquid and gas low per unit area. High porosity also provides high surface area for adsorption or binding
- Clean: As part of comprehensive quality program, only high purity raw materials and reagents are used to produce BRBLS membranes.
- Strong: BRBLS™ membranes are monitored for both burst and tensile strength. PTFE and Nylon are very strong for most aggressive applications.

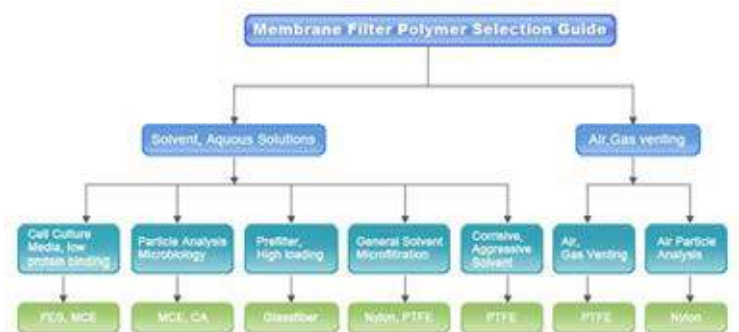

Sterile MiCE membrane filter, gridded, individually package

Cat No.	Product	Package	Price (₹)
CLSMCE047022GWS	MCE Gridded Membrane Filter, White, Sterile, 0.22(µm), 47(mm)	100	4680.00
CLSMCE047045GWS	MCE Gridded Membrane Filter, White, Sterile, 0.45(µm), 47(mm)	100	4680.00



Cat No.	Product	Package	Price
CLSMCE047080GWS	MCE Gridded Membrane Filter, White, Sterile, 0.8(μm), 47(mm)	50	4680.00
CLSMCE050022GWS	MCE Gridded Membrane Filter, White, Sterile, 0.22(μm), 50(mm)	50	4680.00
CLSMCE050045GWS	MCE Gridded Membrane Filter, White, Sterile, 0.45(μm), 50(mm)	50	4680.00
CLSMCE050080GWS	MCE Gridded Membrane Filter, White, Sterile, 0.8(μm), 50(mm)	50	4680.00
CLSMCE047022GWSP	MCE Gridded Membrane Filter, White, Sterile, 0.22(μm), 47(mm),With Pad	50	6600.00
CLSMCE047045GWSP	MCE Gridded Membrane Filter, White, Sterile, 0.45(μm), 47(mm),With Pad	50	6600.00
CLSMCE047080GWSP	MCE Gridded Membrane Filter, White, Sterile, 0.80(μm), 47(mm),With Pad	50	6600.00



Nylon Membrane Filter

Cat No.	Product	Package	Price
CLSNY013022	Nylon Membrane Filter, Pore:0.22(μm), Diameter:13(mm)	50	5640.00
CLSNY025022	Nylon Membrane Filter, Pore:0.22(μm), Diameter:25(mm)	50	4800.00
CLSNY047022	Nylon Membrane Filter, Pore:0.22(μm), Diameter:47(mm)	50	7650.00
CLSNY090022	Nylon Membrane Filter, Pore:0.22(μm), Diameter:90(mm)	50	11190.00
CLSNY142022	Nylon Membrane Filter, Pore:0.22(μm), Diameter:142(mm)	50	16410.00
CLSNY293022	Nylon Membrane Filter, Pore:0.22(μm), Diameter:293(mm)	25	20850.00
CLSNY013045	Nylon Membrane Filter, Pore:0.45(μm), Diameter:13(mm)	50	5640.00
CLSNY025045	Nylon Membrane Filter, Pore:0.45(μm), Diameter:25(mm)	50	4800.00
CLSNY047045	Nylon Membrane Filter, Pore:0.45(μm), Diameter:47(mm)	50	7650.00
CLSNY090045	Nylon Membrane Filter, Pore:0.45(μm), Diameter:90(mm)	50	11190.00
CLSNY142045	Nylon Membrane Filter, Pore:0.45(μm), Diameter:142(mm)	50	16410.00
CLSNY293045	Nylon Membrane Filter, Pore:0.45(μm), Diameter:293(mm)	25	21750.00
CLSNY013080	Nylon Membrane Filter, Pore:0.8(μm), Diameter:13(mm)	50	8460.00
CLSNY025080	Nylon Membrane Filter, Pore:0.8(μm), Diameter:25(mm)	50	7200.00
CLSNY047080	Nylon Membrane Filter, Pore:0.8(μm), Diameter:47(mm)	50	11475.00
CLSNY090080	Nylon Membrane Filter, Pore:0.8(μm), Diameter:90(mm)	50	16785.00
CLSNY142080	Nylon Membrane Filter, Pore:0.8(μm), Diameter:142(mm)	50	24615.00
CLSNY293080	Nylon Membrane Filter, Pore:0.8(μm), Diameter:293(mm)	25	32625.00
CLSNY013100	Nylon Membrane Filter, Pore:1.2(μm), Diameter:13(mm)	50	8460.00
CLSNY025100	Nylon Membrane Filter, Pore:1.2(μm), Diameter:25(mm)	50	7200.00
CLSNY047100	Nylon Membrane Filter, Pore:1.2(μm), Diameter:47(mm)	50	11475.00
CLSNY090100	Nylon Membrane Filter, Pore:1.2(μm), Diameter:90(mm)	50	16785.00
CLSNY142100	Nylon Membrane Filter, Pore:1.2(μm), Diameter:142(mm)	50	24615.00
CLSNY293100	Nylon Membrane Filter, Pore:1.2(μm), Diameter:293(mm)	25	32625.00
CLSNY013300	Nylon Membrane Filter, Pore:3.0(μm), Diameter:13(mm)	50	8460.00
CLSNY025300	Nylon Membrane Filter, Pore:3.0(μm), Diameter:25(mm)	50	7200.00
CLSNY047300	Nylon Membrane Filter, Pore:3.0(μm), Diameter:47(mm)	200	11475.00
CLSNY090300	Nylon Membrane Filter, Pore:3.0(μm), Diameter:90(mm)	50	16785.00
CLSNY142300	Nylon Membrane Filter, Pore:3.0(μm), Diameter:142(mm)	50	24615.00
CLSNY293300	Nylon Membrane Filter, Pore:3.0(μm), Diameter:293(mm)	25	32625.00
CLSNY013500	Nylon Membrane Filter, Pore:5.0(μm), Diameter:13(mm)	50	8460.00



Cat No.	Product	Package	Price
CLSNY025500	Nylon Membrane Filter, Pore:5.0(μm), Diameter:25(mm)	50	7200.00
CLSNY047500	Nylon Membrane Filter, Pore:5.0(μm), Diameter:47(mm)	50	11475.00
CLSNY090500	Nylon Membrane Filter, Pore:5.0(μm), Diameter:90(mm)	50	16785.00
CLSNY142500	Nylon Membrane Filter, Pore:5.0(μm), Diameter:142(mm)	50	24615.00
CLSNY293500	Nylon Membrane Filter, Pore:5.0(μm), Diameter:293(mm)	25	32625.00

Hydrophilic PTFE Membrane Filter (Poly(Tetrafluoroethylene))

Cat No.	Product	Package	Price
CLSPTFE013022L	Hydrophilic PTFE Membrane Filter, Pore:0.22(μm), Diameter:13(mm)	50	16878.00
CLSPTFE025022L	Hydrophilic PTFE Membrane Filter, Pore:0.22(μm), Diameter:25(mm)	50	15762.00
CLSPTFE047022L	Hydrophilic PTFE Membrane Filter, Pore:0.22(μm), Diameter:47(mm)	50	29670.00
CLSPTFE090022L	Hydrophilic PTFE Membrane Filter, Pore:0.22(μm), Diameter:90(mm)	50	56370.00
CLSPTFE013045L	Hydrophilic PTFE Membrane Filter, Pore:0.45(μm), Diameter:13(mm)	50	16878.00
CLSPTFE025045L	Hydrophilic PTFE Membrane Filter, Pore:0.45(μm), Diameter:25(mm)	50	15762.00
CLSPTFE047045L	Hydrophilic PTFE Membrane Filter, Pore:0.45(μm), Diameter:47(mm)	50	29670.00
CLSPTFE090045L	Hydrophilic PTFE Membrane Filter, Pore:0.45(μm), Diameter:90(mm)	50	56370.00

CA Membrane Filter (Cellulose Acetate)

Cat No.	Product	Package	Price
CLSCA013022	CA Membrane Filter, Pore:0.22(μm), Diameter:13(mm)	50	7158.00
CLSCA025022	CA Membrane Filter, Pore:0.22(μm), Diameter:25(mm)	50	5820.00
CLSCA047022	CA Membrane Filter, Pore:0.22(μm), Diameter:47(mm)	50	7077.00
CLSCA090022	CA Membrane Filter, Pore:0.22(μm), Diameter:90(mm)	50	9720.00
CLSCA142022	CA Membrane Filter, Pore:0.22(μm), Diameter:142(mm)	50	12240.00
CLSPTFE090045L	Hydrophilic PTFE Membrane Filter, Pore:0.45(μm), Diameter:90(mm)	50	56370.00

PES Membrane Filter (Polyethersulfone)

Cat No.	Product	Package	Price
CLSPES013022	PES Membrane Filter, Pore:0.22(μm), Diameter:13(mm)	50	7584.00
CLSPES025022	PES Membrane Filter, Pore:0.22(μm), Diameter:25(mm)	50	7020.00
CLSPES047022	PES Membrane Filter, Pore:0.22(μm), Diameter:47(mm)	50	13845.00
CLSPES090022	PES Membrane Filter, Pore:0.22(μm), Diameter:90(mm)	50	26010.00
CLSPES142022	PES Membrane Filter, Pore:0.22(μm), Diameter:142(mm)	50	39690.00
CLSPES013045	PES Membrane Filter, Pore:0.45(μm), Diameter:13(mm)	50	7584.00
CLSPES025045	PES Membrane Filter, Pore:0.45(μm), Diameter:25(mm)	50	7020.00
CLSPES047045	PES Membrane Filter, Pore:0.45(μm), Diameter:47(mm)	50	13845.00
CLSPES090045	PES Membrane Filter, Pore:0.45(μm), Diameter:90(mm)	50	26010.00
CLSPES142045	PES Membrane Filter, Pore:0.45(μm), Diameter:142(mm)	50	39690.00
CLSPES013010	PES Membrane Filter, Pore:0.1(μm), Diameter:13(mm)	50	12276.00
CLSPES025010	PES Membrane Filter, Pore:0.1(μm), Diameter:25(mm)	50	10530.00
CLSPES047010	PES Membrane Filter, Pore:0.1(μm), Diameter:47(mm)	50	20769.00
CLSPES090010	PES Membrane Filter, Pore:0.1(μm), Diameter:90(mm)	50	39000.00



PVDF Membrane Filter (Polyvinylidene fluoride)

Cat No.	Product	Package	Price
CLSPVDF013022	PVDF Membrane Filter, Pore: 0.22(μm), Diameter: 13(mm)	50	7695.00
CLSPVDF025022	PVDF Membrane Filter, Pore: 0.22(μm), Diameter: 25(mm)	50	8289.00
CLSPVDF047022	PVDF Membrane Filter, Pore: 0.22(μm), Diameter: 47(mm)	50	12750.00
CLSPVDF090022	PVDF Membrane Filter, Pore: 0.22(μm), Diameter: 90(mm)	50	21240.00
CLSPVDF142022	PVDF Membrane Filter, Pore: 0.22(μm), Diameter: 142(mm)	50	30222.00
CLSPVDF013045	PVDF Membrane Filter, Pore: 0.45(μm), Diameter: 13(mm)	50	7695.00
CLSPVDF025045	PVDF Membrane Filter, Pore: 0.45(μm), Diameter: 25(mm)	50	8289.00
CLSPVDF047045	PVDF Membrane Filter, Pore: 0.45(μm), Diameter: 47(mm)	50	12750.00
CLSPVDF090045	PVDF Membrane Filter, Pore: 0.45(μm), Diameter: 90(mm)	50	19377.00
CLSPVDF142045	PVDF Membrane Filter, Pore: 0.45(μm), Diameter: 142(mm)	50	30222.00

PP Membrane Filter (Polypropylene)

Cat No.	Product	Package	Price
CLSP025022	PP Membrane Filter, Pore:0.22(μm), Diameter:25(mm)	50	5252.00
CLSP047022	PP Membrane Filter, Pore:0.22(μm), Diameter:47(mm)	50	7859.00
CLSP090022	PP Membrane Filter, Pore:0.22(μm), Diameter:90(mm)	50	8338.00
CLSP142022	PP Membrane Filter, Pore:0.22(μm), Diameter:142(mm)	50	9738.00
CLSP250022	PP Membrane Filter, Pore:0.22(μm), Diameter:250(mm)	50	12571.00
CLSP293022	PP Membrane Filter, Pore:0.22(μm), Diameter:293(mm)	25	16129.00
CLSP025045	PP Membrane Filter, Pore:0.45(μm), Diameter:25(mm)	50	4728.00
CLSP047045	PP Membrane Filter, Pore:0.45(μm), Diameter:47(mm)	50	7074.00
CLSP090045	PP Membrane Filter, Pore:0.45(μm), Diameter:90(mm)	50	7548.00
CLSP142045	PP Membrane Filter, Pore:0.45(μm), Diameter:142(mm)	50	8763.00
CLSP250045	PP Membrane Filter, Pore:0.45(μm), Diameter:250(mm)	50	11316.00
CLSP293045	PP Membrane Filter, Pore:0.45(μm), Diameter:293(mm)	25	14511.00

Nitrocellulose Transfer (Blotting) Membrane

Pure esters of nitrocellulose, free of acetate and other esters. Maximal protein/nucleic acid binding. upto 80 to 100 μg/cm² Nitrocellulose membranes are easily blocked, wet out naturally & do not require methanol. Recommended for western blotting. Two pore sizes available : 0.45 μm is suitable for protein & most blotting applications, 0.2 μm sizes for lower molecular weights.

Cat No.	Size	Micron Rating	Nos./Pkt.	Price
CLSNM101	300 mm x 300 mm	0.45	10	15920.00
CLSNM102	200 mm x 200 mm	0.45	10	12800.00
CLSNM103	100 mm x 100 mm	0.45	10	6400.00
CLSNM104	300 mm x 3 mts	0.45	One Roll	15840.00
CLSNM105	300 mm x 300 mm	0.20	10	15920.00
CLSNM106	200 mm x 200 mm	0.20	10	12800.00
CLSNM107	100 mm x 100 mm	0.20	10	6400.00
CLSNM108	300 mm x 3 mts	0.20	One Roll	



Filter Paper

Qualitative Filter Paper

Cat No	Diameter (mm)	Packing	Price
CLSQF102	60*60cm	100pcs/pack	23350.00
CLSQF103	7cm	100pcs/box	618.00
CLSQF104	9cm	100pcs/box	828.00
CLSQF105	11cm	100pcs/pack	1170.00
CLSQF106	12.5cm	100pcs/pack	1434.00
CLSQF107	15cm	100pcs/pack	1848.00
CLSQF108	18cm	100pcs/pack	2478.00
CLSQF109	20cm	100pcs/pack	3156.00
CLSQF110	24cm	100pcs/pack	4740.00
CLSQF111	25cm	100pcs/pack	5100.00
CLSQF112	28cm	100pcs/pack	6300.00



Ashless Filter Paper

Cat No	Diameter (mm)	Packing	Price
CLSQF202	7cm	100 pcs per/pack	1494.00
CLSQF203	9cm	100 pcs per/pack	2178.00
CLSQF204	11cm	100 pcs per/pack	3078.00
CLSQF205	12.5cm	100 pcs per/pack	3798.00
CLSQF206	15cm	100 pcs per/pack	4872.00
CLSQF207	18cm	100 pcs per/pack	6906.00

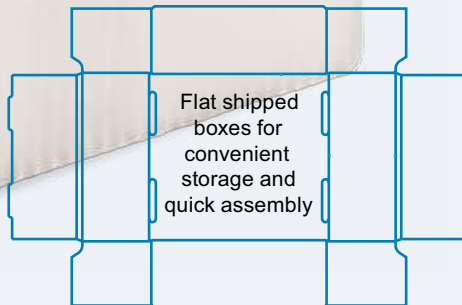
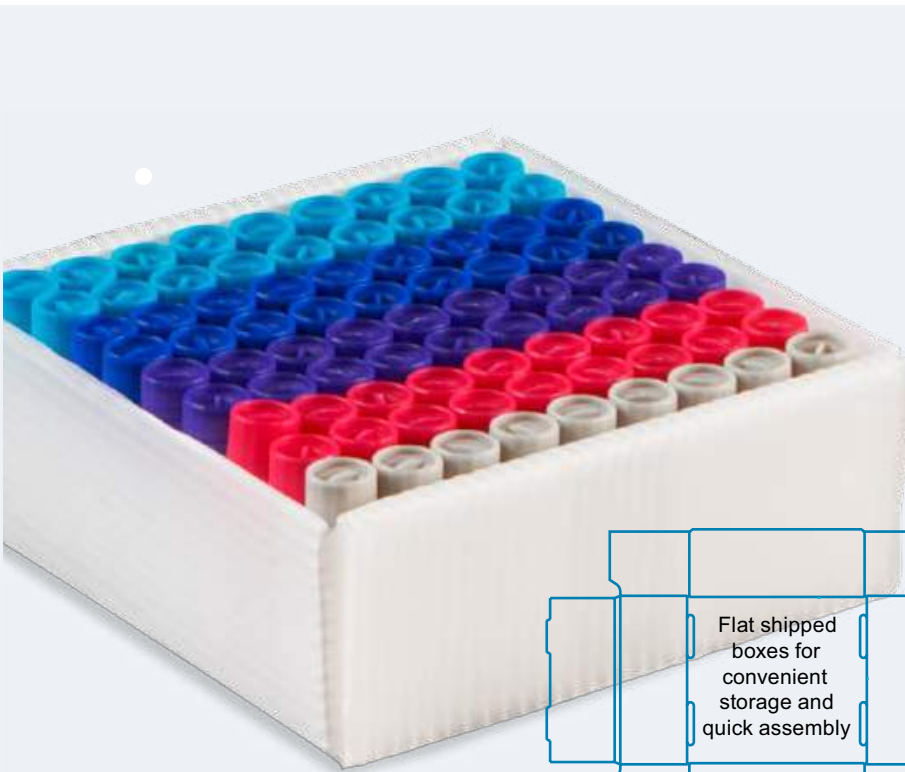

Flatpack Freezer Boxes
Reusable, economical and moisture resistant plastic

These easy self-assemble boxes come flat-packed, ensuring valuable lab space is not taken up storing the boxes before they are needed. Made from corrugated polypropylene, they are more durable than card boxes as they are not susceptible to moisture, so they can be frozen and thawed numerous times without a problem.

- Pre-assembled dividers included with the boxes.
- Store down to temperatures of -80°C
- Holds 81 x 12 mm (max. diameter) tubes in a 9 x 9 format
- Complete with well dividers in packs of 10



Sea Star® Vortexer®

Multi-purpose, maximum convenience

- Variable speed rotary dial provides finite speed control during vortex mixing
- Stable elastomeric device feet, provide vibration dampening and prevent movement during operation
- Innovative head can be removed for cleaning purposes



Specifications

- Speed Range: Variable 500-3000 rpm (shaking to vortexing)
- Orbit: 4.2 mm
- Control: 3 position switch-continuous, intermittent, manual, and off

Holding capacity (plus a center cup)

- Assay Plate x 1
- 50 mL conical tubes x 2
- 15 mL conical tubes x 2
- 1.5/2 mL microfuge tubes x 4
- 0.5 mL microfuge tubes x 6
- 0.2 mL microfuge tubes x 24



Cat No	Description	Price
CLS120214	Sea Star® Vortexer 220V AC, 50/60 Hz	28,000.00

Sea Star® Digital Orbital Shaker

Multipurpose compact universal shaker

- No-stop optical motor feedback, enables the unit to instantly adjust to weight load changes and unbalanced loads for truly reproducible results
- Suitable for use in incubators and cold rooms within the stated temperature range
- Soft-start feature reduces spill instances from full vessels
- A high weight loading of 4.5 kg, with an overload protection cut out



Specifications

- Speed range: 20 to 300 rpm 1 rpm increments
- Orbit diameter: 19.2 mm
- Timer range: 0 to 49 hours, 1 second increments or continuous
- Maximum load: 4.5 kg



Bungee cords allows you to create your own holding matrix for vessels of all shapes and sizes

Cat No	Description	Price
CLS4010A	Sea Star® Digital Orbital Shaker, 110–240 VAC, 50/60 Hz	95,000.00

Micro Tubes

Made from 100% virgin polypropylene, certified DNase, RNase and Pyrogen free and capable of withstanding high centrifugal forces. The natural colored tubes offer superior clarity, while the pure black version protects and prolongs the life of more light sensitive products.



Microtubes - 0.2, 0.5 and 1.5 mL

- Attached flat caps for easy one handed use, fully autoclavable
- 0.2 mL is suitable for Thermal Cyclers. The slender shape evenly distributes uniform heat
- 0.5 and 1.5 mL versions have a frosted writing area and a syringe pierceable cap

Cat No	Volume	Dimension	Noted Graduation	Pack	Price
CLS4423	0.2 mL	Max OD 6.9 mm	None	1000/pk	11,828.00
CLS4422	0.5 mL	Max OD 10.1 mm	0.1, 0.3, 0.5	1000/pk	7,941.00
CLS4323	1.5 mL	Max OD 12.9 mm	0.1, 0.5, 1.0	500/pk	3,717.00
CLS4323K	1.5 mL	Max OD 13.4 mm	0.1, 0.5, 1.0, 1.5	500/pk	4,292.00
CLS4325	1.5 mL	Max OD 12.9 mm	0.1, 0.5, 1.0	1000/pk	7,398.00

Centrifuge Tubes

Large Capacity Tubes - 15 and 50 mL

- Lot-to-lot traceability with easy tear packaging
- Writing area and flat polyethylene lids for easy labelling
- Imprinted graduations and a self-standing version (only in clear bulk pack)
- Reusable card used for the racked versions, making them more environmentally friendly



Cat No	Volume	Dimension	Noted Graduation	Pack	Price
CLS4426B	15 mL	OD 17 mm + 0.3 mm Length 120 mm + 2 mm	0.5 mL	500/pk	33,719.00
CLS4426R	15 mL	OD 17 mm + 0.3 mm Length 120 mm + 2 mm	0.5 mL	500/pk	36,172.00
CLS4428	15 mL	OD 17 mm + 0.3 mm Length 120 mm + 2 mm	0.5 mL	500/pk	49,000.00
CLS4427B	20 mL	OD 29 mm + 0.3 mm Length 114 mm + 2 mm	5.0 mL	500/pk	46,600.00
CLS4429	50 mL	OD 29 mm + 0.3 mm Length 114 mm + 2 mm	5.0 mL	500/pk	67,000.00
CLS4427S	50 mL	OD 29 mm + 0.3 mm Length 114 mm + 2 mm	5.0 mL	500/pk	47,850.00

Screw-Top Tubes with O-Ring Cap

Screw-on polypropylene lids with TPE O-Ring to create an excellent seal for secure storage.

- Clear polypropylene tubes provide excellent view of samples
- Skirted, self-standing base makes filling and retrieval easy
- Ideal for sample processing and storage application

Cat No	Volume	Dimension	Noted Graduation	Pack	Price
CLS10060	2.0 mL	Max OD 13.3 mm Closed height 46.7 mm	0.5, 1.0, 1.5	500/pk	19,726.00

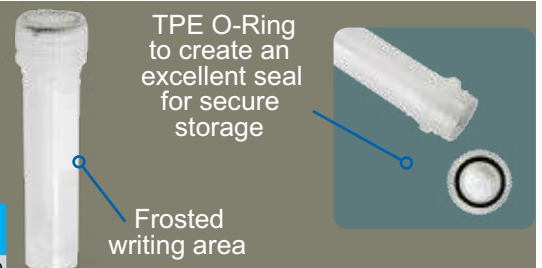

TPE O-Ring to create an excellent seal for secure storage

Frosted writing area

Sprout® Mini-Centrifuge

Sprout® Package includes:

- Sprout® Mini-Centrifuge
- 6 place 1.5/2.0 mL tube rotor
- 16 place 0.2 mL tube rotor (singles, or 2 x 8 Strip)
- 6 tube adapters 0.2 mL
- 6 tube adapters 0.5 mL
- Storage case for rotors and adapters
- Tube rack
- Power cord

Specifications

- Maximum speed: 6,000 rpm
- Maximum RCF: 2000 x g
- Power: Regional specific versions
- Dimensions: 153 x 128 x 104 mm



Change out rotors with the push of a button



Cat No	Description	Price
CLS10022	Sprout® Mini-Centrifuge	20,000.00

Gusto® High-Speed Mini-Centrifuge

This compact centrifuge is ideal for protocols calling for fast spins with a higher RCF requirement. Ideal for PCR®, microfilter cell separation, clinical & diagnostic applications, and HPLC protocols

- Compact footprint and brush-less motor for quiet operation and low vibration
- Select and set the digital speed display in xg or rpm
- Sample imbalance and tilt safety cut out
- Safety interlock lid prevents opening while rotor is turning
- Made from UV-resistant plastic, increasing its useful life under harsh light conditions
- Double insulated construction
- Push button lid release
- Manual override allows user to open lid in case of power failure



Specifications

- Speed: 500–12,500 rpm
- RCF: 15–9, 800 Xg
- Power: 110 to 240 VAC, 50/60 Hz with 4 interchangeable plug adapters

Gusto® Package includes:

- Gusto™ High-Speed Mini-Centrifuge
- 12 place 1.5/2.0 mL tube rotor
- 32 place 0.2 mL tube rotor (singles, or 4 x 8 Strip)
- 12 tube adapters 0.2 mL
- 12 tube adapters 0.5 mL
- Universal power adapter 110–240V 50/60 Hz, with 4 interchangeable plug type

Cat No	Description	Price
CLS10050	Gusto™, 110–240 VAC, 50/60 Hz	75,000.00

Universal Tube Rack

Quickly change tube sizes with this adaptable polypropylene rack. Open the well with a turn of the knob or directly insert a tube into the opening.

- Holds up to 12 similar size tubes
- Imprinted references for easy identification
- Generously-sized handles for easy transport
- Accepts tubes and vessels from 16–30 mm in size

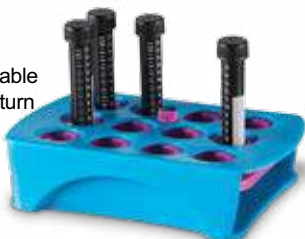

Cat No	tubes	wells	Price
CLS24330A	15–50 mL	12	11,900.00

Grab Rack®

Rack features silicon grips to hold tubes in place

Turn the rack over and the tubes will not fall out! Great for discarding liquids while tubes stay in place.

- Tubes insert and extract with a gentle push or pull
- ABS rack with silicon gripping fingers. No assembly required
- Not recommended for cleaning in autoclave
- measures 259 x 127 x 49 mm

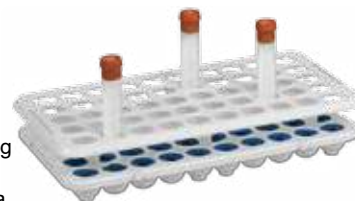

Cat No	Description	Tubes	Wells	Price
CLS24371A	Grab Rack	16 mL	50	5,517.00

ADAPT-A-RACK®

Capable of holding different size tubes in each available slot as the well literally adapts to your tube size to hold firmly in an upright position. The design enables you to hold 12 mm to 30 mm (5 mL to 50 mL) tubes simultaneously and still allow full viewing of the tube label

- Open sides allow for label viewing
- Flat base to hold tubes upright
- Linked racks should be supported underneath when carrying



Cat No	Rack #1 Color Top/Bottom	Rack #2 Color Top/Bottom	Pack	Price
CLS120184	Blue/Green	Blue/Green	2 Rack/Box	2,512.00
CLS120185	Blue/Yellow	Blue/Yellow	2 Rack/Box	2,512.00
CLS120186	Pink/White	Pink/White	2 Rack/Box	2,512.00
CLS120187	Blue/Blue	Blue/Blue	2 Rack/Box	2,512.00
CLS120188	White/White	White/White	2 Rack/Box	2,512.00
CLS120189	Pink/Pink	Pink/Pink	2 Rack/Box	2,512.00
CLS120190	Yellow/Yellow	Yellow/Yellow	2 Rack/Box	2,512.00
CLS120191	Green/Green	Green/Green	2 Rack/Box	2,512.00

Microtube Racks 80-Well

• Easily fill and transfer 80 tubes in compact arrangement (5 x 16 array).

- Polypropylene rack has molded-in coordinates to aid organization
- Measures 225 x 67 x 28 mm. Pack of 5



Cat No	Tubes	Well	Color	Price
CLS29025A	1.5/2.0 mL	80	Natural	4,731.00
CLS29025B	1.5/2.0 mL	80	Blue	4,731.00
CLS29025C	1.5/2.0 mL	80	Green	4,731.00
CLS29025D	1.5/2.0 mL	80	Pink	4,731.00
CLS29025E	1.5/2.0 mL	80	Yellow	4,731.00
CLS29025F	1.5/2.0 mL	80	Orange	4,731.00
CLS29025G	1.5/2.0 mL	80	Assorted Color	4,731.00
CLS29025J	1.5/2.0 mL	80	Red	4,731.00

3 Way Rack

Rack measures 164 x 123 x 62 mm.

- Made of polypropylene
- Finger slots are molded into the rack for easy pickup and moving
- Racks connect to one another on either end
- Autoclavable



Cat No	Tubes	Pack Size	Well	Color	Price
CLS4289B	0.2 mL	6	24	Assorted Color	9,124.00
	0.5 mL	6	14		
	1.5/2.0 mL	6	12		

PCR® Racks Reversible

- PCR® side of the rack holds 8 or 12 x 0.2 mL tube strips or individual tubes
- Opposite side holds 0.5 mL tubes
- Both sides of the rack have 12 wells for 1.5 mL tubes
- Measures 206 x 131 x 54 mm.

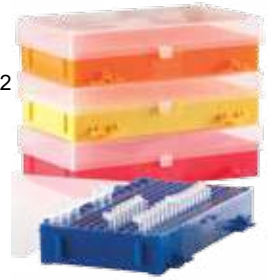

Pack Size: 5

Cat No	Tubes	Well	Color	Price
	1.5/2.0 mL (both sides)	12		
CLS2344A	0.2 mL (one side)	168	Assorted Color	11,830.00
	0.5 mL (one side)	40		

Reversible Racks 96-Well

Flip polypropylene rack from 96 wells for 0.5 mL tubes on one side to 96 wells for 1.5/2.0 mL tubes on the other side.



Cat No	Tubes	Pack	Well	Color	Price
CLS2345A	1.5/2.0 mL 0.5 mL	5	96	Assorted Color	12,000.00
CLS2345B	1.5/2.0 mL 0.5 mL	5	96	Natural	12,000.00
CLS2345C	1.5/2.0 mL 0.5 mL	5	96	Blue	12,000.00
CLS2345D	1.5/2.0 mL 0.5 mL	5	96	Green	12,000.00
CLS2345E	1.5/2.0 mL 0.5 mL	5	96	Pink	12,000.00
CLS2345F	1.5/2.0 mL 0.5 mL	5	96	Yellow	12,000.00

Tube Rack 20-well

Interlock multiple racks to increase tube storage. Polypropylene racks lock together on each side.



Pack Size: 6

Cat No	Tubes	Well	Color	Price
CLS4284A	0.5/1.0/1.5/2.0 mL 0.5 mL	20	Blue	9,970.00

PCR® Racks 96-Well

Sturdy polypropylene rack accommodates individual tubes or strips of 8 or 12 tubes.



Pack Size: 5

Cat No	Tubes	Well	Color	Price
CLS23461A	0.2 mL	96	Assorted Color	8,450.00
CLS23461B	0.2 mL	96	Natural	8,450.00
CLS23461C	0.2 mL	96	Blue	8,450.00
CLS23461D	0.2 mL	96	Green	8,450.00

50-Well Microtube Storage Boxes

For smaller storage requirements of 1.5/2.0 mL microtubes or cryogenic vials.

Pack Size: 5



Cat No	Tubes	Pack	Well	Color	Price
CLS120032	1.5/2.0 mL	5	50	Natural	6,051.00
CLS120033	1.5/2.0 mL	5	50	Assorted Color	6,051.00

81-Well Microtube Storage Boxes

Store 1.5/2.0 mL microtubes or cryogenic vials in polypropylene storage boxes, with an easy open, friction fit lid.

- Black light tight version available for light sensitive samples
- Measures 130 x 130 x 47 mm and will fit into most standard freezer racking
- Pack of 5



Cat No	Tubes	Well	Color	Price
CLS120034	1.5/2.0 mL	81	Natural	8,620.00
CLS120035	1.5/2.0 mL	81	Blue	8,620.00
CLS120036	1.5/2.0 mL	81	Green	8,620.00
CLS120037	1.5/2.0 mL	81	Pink	8,620.00
CLS120038	1.5/2.0 mL	81	Yellow	8,620.00
CLS120039	1.5/2.0 mL	81	Orange	8,620.00
CLS120040	1.5/2.0 mL	81	Assorted Color	8,620.00
CLS120041	1.5/2.0 mL	81	Black	8,620.00

100-Well Microtube Storage Boxes

For larger storage requirements of 1.5/2.0 mL microtubes or cryogenic vials.

- Black, light-tight version available for light sensitive samples

Pack Size: 5



Cat No	Tubes	Well	Color	Price
CLS120042	1.5/2.0 mL	100	Natural	9,901.00
CLS120043	1.5/2.0 mL	100	Black	9,901.00
CLS120044	1.5/2.0 mL	100	Assorted Color	9,901.00
CLS120201	1.5/2.0 mL	100	Blue	9,903.00
CLS120202	1.5/2.0 mL	100	Green	9,903.00
CLS120203	1.5/2.0 mL	100	Yellow	9,903.00
CLS120204	1.5/2.0 mL	100	Orange	9,903.00

Work2Store™ & Work2Store™ Micro Expanding Storage Boxes

Single rack, double function

Reduce sample handling time and the need for several racks when working with samples for cold temperature storage. Patent-pending opening and closing mechanism allows the rack to expand, creating needed room for sample manipulation. Then simply collapse the rack back to its compact form and it is ready for the freezer. Temperature range -80 to 121°C. Two versions now available the original for holding 1.5/2.0 mL cryo and micro tubes and now the new Micro reversible version for holding 0.5 mL and 0.2 mL tubes (see below)

- Instantly creates more working space
- Helps reduce potential cross contamination
- Stops opened microfuge lids from interfering with other wells
- Stackable, autoclavable and with alphanumeric well identifications
- Will fit into standard 2" (53 mm) freezer racking

Work2Store™



Work2Store™ Micro



Work2Store^a

- Clear lid locks the rack together for safe handling and transportation
- Wells have a center depression to stabilize conical tubes and a cryogenic vial lock for one handed cap removal
- Holds 64 x 1.5/2.0 mL cry and/or micro tubes

Work2Store^a Micro

- 0.2 mL tube side has been configured to work 8 strip, 12 strip or single tubes
- Reversible rack which will hold
- 64 x 0.5 mL micro tubes on one side and 96 x 0.2 mL micro tubes on the other side

Cat No	Description	Tubes	Well	Price
CLS120018	Work2Store™	1.5/2.0 mL	64	6,500.00
CLS120183	Work2Store™ Micro	0.5/0.2 mL	64/96	6,500.00

Cardboard Cryogenic Vial Boxes & Partitions

For storage of small samples and tubes

- Store in LN₂ or in mechanical freezers
- Bottom vent holes to allow quicker circulation and removal of cold air, vapor or LN₂
- All box footprints are 13.3 x 13.3 cm, select from two different heights
- Pack Size: 12 Pack



Cat No	Tubes	Color	Height	Price
CLS2860A	Vial Box and Lid	White	50 mm	8,189.00
CLS2860B	Vial Box and Lid	White	75 mm	8,871.00
CLS2860C	Vial Box and Lid	Assorted Color	50 mm	8,800.00
CLS2860CB	Vial Box and Lid	Blue	50 mm	8,800.00
CLS2860CR	Vial Box and Lid	Red	50 mm	8,800.00
CLS2860CY	Vial Box and Lid	Yellow	50 mm	8,800.00
CLS2860E	100-Cell Partition (10 x 10)	Max. tube dia 11.5 mm		6,824.00
CLS2860H	81-Cell Partition (9 x 9)	Max. tube dia 12 mm		6,824.00
CLS2860F	64-Cell Partition (8 x 8)	Max. tube dia 15 mm		6,500.00
CLS2860G	49-Cell Partition (7 x 7)	Max. tube dia 17.5 mm		6,500.00

Cardboard Micro Tube Boxes

- Store in mechanical freezers or vapor phase LN₂*
- Will fit into most standard freezer racking
- 0.2 mL tube (9.5 mm max) version has 169 wells in a 13 x 13 format
- 0.5 mL tube (12 mm max) version has 100 wells in a 10 x 10 format



Cat No	Description	Tubes	Well	Qty	Price
CLS120220	Cardboard Micro Tube Boxes	0.2 mL	169	PK/10	13,520.00
CLS120221	Cardboard Micro Tube Boxes	0.2 mL	100	PK/10	13,520.00

Flatpack Freezer Boxes

These easy self-assemble boxes come flat-packed, ensuring valuable lab space is not taken up storing the boxes before they are needed. Made from corrugated polypropylene, they are more durable than card boxes as they are not susceptible to moisture, so they can be frozen and thawed numerous times without a problem.



- Flat shipped boxes for convenient storage and quick assembly.
- Pre-assembled dividers included with the boxes.
- Store down to temperatures of -80°C
- Holds 81 x 12 mm (max. diameter) tubes in a 9 x 9 format
- Complete with well dividers in packs of 10

Cat No	Description	Tubes	Well	Qty	Price
CLS120262	Corrugated Polypropylene Box with Divider	12 mm	81	PK/10	11,600.00

Foam Tube Rack

Lightweight microtube racks are ideal for long-term studies or tube storage

- Holds 1.5 and 2.0 mL micro tubes. Pack of 10



Cat No	Well	Dimension	Price
CLS4282	100	336 x 95 x 73	13,180.00
CLS4283A	50	210 x 110 x 71	10,500.00

Cardboard Tube Racks and Partitions

- Partitions come in two sizes. Wells measure maximum of 17.5 mm and 29.5 mm dia.
- Economical cardboard racks are disposable
- Write-on surface for descriptions or self numbering systems
- Pack of 10



Cat No	Description	Price
CLS2860M	15 and 50 mL Box and Lid	12,400.00
CLS2860P	50 mL, 16 Cell Partion (4 Columns x 4 Row)	6,190.00
CLS2860T	15 mL, 36 Cell Partion (6 Columns x 6 Row)	7,740.00

Freezer Boxes

freezer boxes

Reusable, economical and moisture resistant plastic

- Made from polypropylene material
- Easy self-assemble boxes shipped lat-packed
- More durable than card boxes as they are not susceptible to moisture
- Significantly reduces the chance of mold
- Dividers included with the boxes
- Store down to temperatures of -80°C

Corrugated Polypropylene 0.2/0.5/1.5-2.0/5 mL

CLS120367



CLS120381



Cat. No.	Products	Place	Pack size	Price
CLS120379	Flatpack Freezer Boxes White, 0.2ml	144 place	10/pk	15,704.00
CLS120380	Flatpack Freezer Boxes Blue, 0.2ml	144 place	10/pk	15,704.00
CLS120381	Flatpack PP Freezer Boxes Red, 0.2ml	144 place	10/pk	15,704.00
CLS120382	Flatpack PP Freezer Boxes Purple, 0.2ml	144 place	10/pk	15,704.00
CLS120383	Flatpack PP Freezer Boxes White, 0.5ml	81 place	10/pk	15,704.00
CLS120384	Flatpack PP Freezer Boxes Blue, 0.5ml	81 place	10/pk	15,704.00
CLS120385	Flatpack PP Freezer Boxes Red, 0.5ml	81 place	10/pk	15,704.00
CLS120386	Flatpack PP Freezer Boxes Purple, 0.5ml	81 place	10/pk	15,704.00
CLS120262	Flatpack PP Freezer Boxes ,White 1.5/2ml	81 place	10/pk	9,980.00
CLS120376	Flatpack PP Freezer Boxes Blue, 1.5/2ml	81 place	10/pk	9,980.00
CLS120377	Flatpack PP Freezer Boxes Red, 1.5/2ml	81 place	10/pk	9,980.00
CLS120378	Flatpack PP Freezer Boxes Purple, 1.5/2ml	81 place	10/pk	9,980.00
CLS120387	Flatpack PP Freezer Boxes White, 5ml	25 place	10/pk	15,704.00
CLS120388	Flatpack PP Freezer Boxes Blue, 5ml	25 place	10/pk	15,704.00
CLS120389	Flatpack PP Freezer Boxes Red, 5ml	25 place	10/pk	15,704.00
CLS120390	Flatpack PP Freezer Boxes Purple, 5ml	25 place	10/pk	15,704.00

Cat. No.	Products	Place	Pack size	Price
CLS120391	Flatpack PP Freezer Boxes White, 15ml	36 place	10/pk	22,000.00
CLS120392	Flatpack PP Freezer Boxes Blue, 15ml	36 place	10/pk	22,000.00
CLS120393	Flatpack PP Freezer Boxes Red, 15ml	36 place	10/pk	22,000.00
CLS120394	Flatpack PP Freezer Boxes Purple, 15ml	36 place	10/pk	22,000.00
CLS120366	Flatpack PP Freezer Boxes White, 50ml	16 place	10/pk	21,100.00
CLS120367	Flatpack PP Freezer Boxes Blue, 50ml	16 place	10/pk	21,100.00
CLS120368	Flatpack PP Freezer Boxes Red, 50ml	16 place	10/pk	21,100.00
CLS120369	Flatpack PP Freezer Boxes Purple, 50ml	16 place	10/pk	21,100.00

Test Tube Rack

5 mL/15 mL/16mm Tube Rack*

This multi-purpose rack is designed with the flexibility to hold 20 - 5 mL, 20 - 15 mL or 16mm tubes OR to hold a40 - 5 mL, 40 - 15 mL or 16 mm tubes. The rack incorporates two moving hinged upper shelves that can be rotated to an up or down position to accommodate the size of the tube being used. In addition, the rack can also hold clinical tubes of a similar diameter (16 mm) and height.

- Rack holds 5 or 15 mL tubes (or tubes up to 16 mm in diameter) or a combination of 20 – 5 mL, 15 mL or 16 mm tubes.
- Unique tear drop shaped openings (top tray) for better retention of tubes
- Ergonomic handles for ease of use
- Imprinted grid on both sides of the upper shelves for quick identification and retrieval
- Shelves can be easily rotated to accommodate the different size tubes



Cat. No.	Product	Wells	Color	Pack Size	Price
CLS120167	Test Tube Rack, 5 mL/15mL	40	Purple Natural	1/pk	7,800.00
CLS120467	Test Tube Rack, 5 mL/15mL	40	Green Blue	1/pk	7,800.00

Trackrack

Take what you need and store the rest

- Segments box made of polypropylene
- Eight segments per box
- 1.5 -2.0 mL cryo and micro-centrifuge tubes (64 tubes)
- A cryogenic vial lock for one-handed cap removal



Cat. No.	Product	Well Dia.	Wells	Color	Pack Size	Price
CLS120356	TracRack, 1.5/2.0 mL	12.3 mm	40	Purple	1/pk	4,754.00

Transformer™ cube

- Polypropylene construction complete with two snap-in grids
- Imprinted grid, first-tube orientation — keyed lid
- Use without grids for larger sized product storage
- Fill with ice and use as a temporary low-temperature workstation
- Clear lid, translucent sides
- Autoclavable



Cat No	Tubes	Pack	Well	Color	Price
CLS23271A	15 mL	1	16	Purple	13,800.00
	50 mL	1	9	Purple	

Trackrack MICRO

Take what you need and store the rest

- Segments box made of polypropylene
- Eight reversible segments per box
- 64 x 0.5 mL tubes, 96 x 0.2 mL micro tubes, or a combination of both



TracRack® Outer Box

- Made from thin film polypropylene material
- Store down to temperatures of -80°C
- Moisture resistant, significantly reducing the chance of mold
- Removable segments allow outer shell to be used for storage of other small laboratory products
- 2 in. (5.3 cm) boxes fit in standard freezer racks

Cat. No.	Product	Well Dia.	Wells	Color	Pack Size	Price
CLS120357	TracRack, 0.2 mL, 0.5 mL	5.1 mm, 7.8 mm	40	Purple	1/pk	4,754.00

Microtube Tube Racks

Reinforced nylon tube racks offering superior chemical and heat resistance over most other plastic based racks.

- Handles provide easy and safe transportation and allow racks to be stacked
- Two formats available for smaller and larger requirements
- Temperature range -40°C to +140°C



Cat No	Tubes	Well	Dimension	Color	Pack	Price
CLS120241	1.5/2.0 mL	24	143 x 90 x 52 mm	Blue	8	13,800.00
CLS120242	1.5/2.0 mL	24	143 x 90 x 52 mm	White	8	15,574.00
CLS120243	1.5/2.0 mL	96	210 x 131 x 54 mm	Blue	4	13,520.00
CLS120244	1.5/2.0 mL	96	210 x 131 x 54 mm	White	4	13,520.00

Test Tube Racks

Tough and more highly resistant to acids, bases, solvents and heat

These durable racks are molded in a single, continuous piece so no assembly required and there are no detachable pieces. Delrin® fiberglass-reinforced polyoxymethylene (POM): Offers the highest chemical and heat resistance (-40 to +140°C)

- Autoclavable, available in half and full rack sizes for 5 tube diameters

Polypropylene:

Offers good chemical and heat resistance (0 to 110°C)

- Not recommended for autoclaving, available in the full size for 2 tube diameters

Both:

- Have molded coordinates for tube orientation
- Designed to be stable when used in water baths
- Have flat labeling area for easier identification
- Available in 5 different colors. Cases of 8



Cat No	Tubes	Well	Dimension	White	Blue	Green	Magenta	Yellow	Price (₹)
Full Size Darlin® Rack Autoclavable	13 mm	72	104 x 202 x 59	CLS27511A	CLS27511B	CLS27511C	CLS27511D	CLS120205	38880
	16 mm	72	127 x 250 x 70	CLS27512A	CLS27512B	CLS27512C	CLS27512D		
	20 mm/15 mL	40	100 x 252 x 83	CLS27513A	CLS27513B	CLS27513C	CLS27513D		38880
	25 mm	40	120 x 300 x 92	CLS27514A	CLS27514B	CLS27514C	CLS27514D		42260
	30/50 mL	24	110 x 282 x 85	CLS27515A	CLS27515B	CLS27515C	CLS27515D	CLS120207	42260
Full Size Darlin® Rack Autoclavable	13 mm	36	104 x 104 x 59	CLS27501A	CLS27501B	CLS27501C	CLS27501D		26130
	16 mm	36	127 x 127 x 70	CLS27502A	CLS27502B	CLS27502C	CLS27502D		27409
	20 mm/15 mL	20	100 x 127 x 83	CLS27503A	CLS27503B	CLS27503C	CLS27503D		29957
	25 mm	16	120 x 122 x 92	CLS27504A	CLS27504B	CLS27504C	CLS27504D		29957
	30 mm/50 mL	9	110 x 110 x 85	CLS27505A	CLS27505B	CLS27505C	CLS27505D		29957
Full Size Polypropylene Rack	13 mm	72	104 x 202 x 59	CLS27551A	CLS27551B	CLS27551C	CLS27551D		25251
	16mm	72	127 x 250 x 70	CLS27552A	CLS27552B	CLS27552C	CLS27552D		25251

Snap-Together Conical Tube Rack

- Shipped flat, easy-to-assemble ABS racks snap together securely
- Designed for stable use in water baths



One-Well 50 mL Connecting Tube Racks

- Molded circular base ring keeps conical or round-bottom tubes in place

Pack Size: 5



Cat No	Tubes	Pack	Well	Color	Price
CLS24306	15 mL	30		Orange	5,271.00
	50 mL	20			

Cat No	Description	Price
CLS23052	1-Well 50 mL Tube Racks, Assorted	8,955.00

One-Well 50 mL Single Tube Racks

Reinforced nylon tube racks offering superior chemical and heat resistance over most other plastic based racks.

- Handles provide easy and safe transportation and allow racks to be stacked
- Two formats available for smaller and larger requirements
- Temperature range -40°C to +140°C



Cat No	Description	Tubes	Well	Color	Price
CLS23051	Epoxy-Coated Wire Rack	50 mL	1	Yellow	3,250.00
CLS23053A	Polystyrene Friction-Fit Rack	50 mL	1	Blue	4,570.00

Pop-Up™ Racks

- Designed to help organize 15 and 50 mL tubes
- Robust polypropylene construction. Not recommended for cleaning in autoclave
- 15 mL max tube dia. 17 mm
- 50 mL max tube dia. 30 mm
- Pack Size: 2



Cat No	Color	Tube	Well	Price
CLS24320B	Blue	15 mL 50 mL	21 12	7,340.00
CLS24320P	Pink	15 mL 50 mL	21 12	7,340.00
CLS24318	Purple	15 mL	45	7,340.00
CLS24319	Green	50 mL	18	7,340.00

Fold and Snap Test Tube Rack

- Easy-to-assemble polypropylene racks fold and snap together
- Available in 4 different colors for 3 popular tube sizes

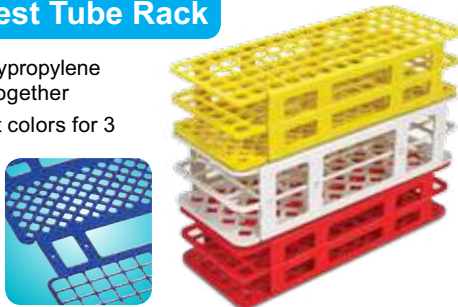

Cat No	Tube	Well	Color	Dimension	Price
CLS243073B	13 mm	90	Blue	245 x 105 x 63 mm	3,000.00
CLS243073W	13 mm	90	White	245 x 105 x 63 mm	3,000.00
CLS243073R	13 mm	90	Red	245 x 105 x 63 mm	3,000.00
CLS243073Y	13 mm	90	Yellow	245 x 105 x 63 mm	3,000.00
CLS243077B	17 mm	60	Blue	245 x 108 x 72 mm	3,000.00
CLS243077W	17 mm	60	White	245 x 108 x 72 mm	3,000.00
CLS243077R	17 mm	60	Red	245 x 108 x 72 mm	3,000.00
CLS243077Y	17 mm	60	Yellow	245 x 108 x 72 mm	3,000.00
CLS243071B	21 mm	40	Blue	245 x 108 x 72 mm	3,000.00
CLS243071W	21 mm	40	White	245 x 108 x 72 mm	3,000.00
CLS243071R	21 mm	40	Red	245 x 108 x 72 mm	3,000.00
CLS243071Y	21 mm	40	Yellow	245 x 108 x 72 mm	3,000.00

Peg Racks

- Spacious peg design allows easy viewing of tube contents
- Use as a drying rack for glass plates or upside-down tubes
- Pegs remain straight even after repeated autoclaving
- Embossed indexing, ribbed grips, and drainage holes
- Pack of 2

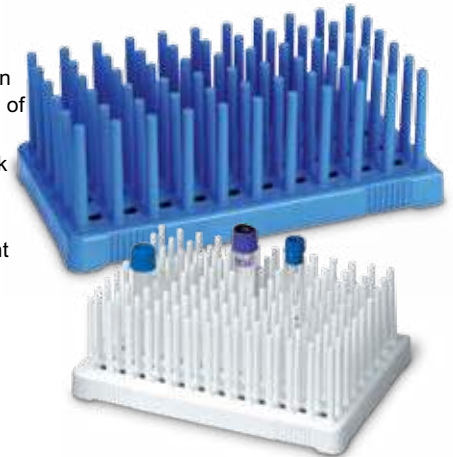

Cat No	Tube	Well	Color	Dimension	Price
CLS24311A	14–17 mm	50	White	188 x 104 x 69 mm	5,070.00
CLS24311B	14–17 mm	50	Blue	188 x 104 x 69 mm	5,070.00
CLS24312A	10–13 mm	96	White	82 x 126 x 69 mm	5,600.00
CLS24312B	10–13 mm	96	Blue	82 x 126 x 69 mm	5,600.00

Mega Racks

Fully-assembled, polypropylene Mega Racks are great for high throughput labs requiring large sample storage.

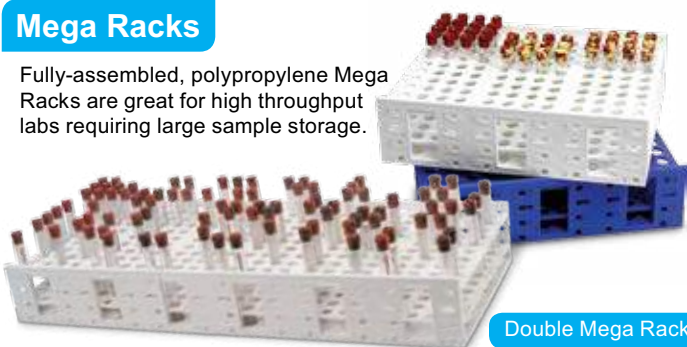

Double Mega Rack

Cat No	Description	Size	Wells	Color	Price
CLS24322A	10–13 mm Tube Rack	single	216	Blue	9,200.00
CLS24322E	10–13 mm Tube Rack	single	216	White	9,200.00
CLS24323A	13–16 mm Tube Rack	single	120	Blue	9,200.00
CLS24323E	13–16 mm Tube Rack	single	120	White	9,200.00
CLS120113	10–13 mm Tube Rack	double	432	White	18,210.00
CLS120112	10–13 mm Tube Rack	double	432	Blue	18,210.00
CLS120115	13–16 mm Tube Rack	double	240	White	18,210.00
CLS120114	13–16 mm Tube Rack	double	240	Blue	18,210.00

Rota-Rack® Duo Tube Rack

- Rotate and customize to suit your application needs. 4 combinations possible
- Blue section holds 48 x 0.5 mL and 48 x 1.5 mL microfuge tubes on the reverse side
- Purple section holds 96 x 0.2 mL tubes in a standard array pattern one and 48 x 1.5 mL tubes on the reverse side
- Tapered wells securely suspend tubes and makes removal easy
- Alphanumeric well identification

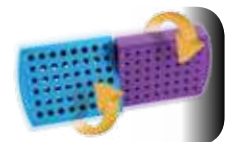

Cat No	Tube	Well	Color	Dimension	Price
CLS29041A	0.2 mL	96	Blue & Purple	296 x 118 x 34	8,600.00
	0.5 mL	48			
	1.5 mL	96			

Rota-Rack® Tube Racks

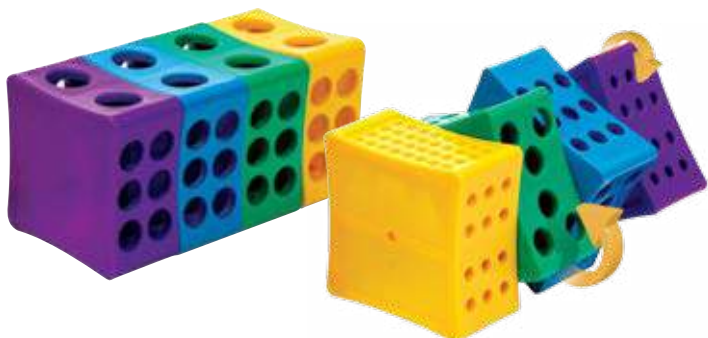

Cat No	Tube	Well	Color	Dimension	Price
CLS29040A	50 mL	9	Assorted Color	224 x 110 x 110 mm	10,500.00
	15 mL	8			
	20 mm	6			
	10-13 mm	10			
CLS29040B	15 mL	6	Assorted Color	210 x 100 x 100 mm	10,500.00
	1.5/2.0 mL	9			
	0.5 mL	12			
	0.2 mL	32			

Puzzle Rack

Two-sided puzzle-shaped pieces hold an assortment of 1.5/2.0, 15 and 50 mL test tubes.

- Pack of 4



Cat No	Tube	Well	Color	Price
CLS29060A	15 mL	9	Assorted Color	13,880.00
	50 mL	4		
	1.5/2.0 mL	8 on top side		
	1.5/2.0 mL	4 on opposite side		

Cube Rack



Interlocking multi-tube racks

- Heavy duty polypropylene rack.
- Pack of 5

Cat No	Tube	Well	Color	Price
CLS29050A	50 mL	4	Assorted Color	11,250.00
	15 mL	10		
	12 mL	12		
	1.5/2.0 mL	16		

4-Way Rack

Link together to cater for your application needs

- Pack of 5



Cat No	Color	Price
CLS29022A	Natural	9,630.00
CLS29022B	Blue	9,630.00
CLS29022C	Green	9,630.00
CLS29022D	Pink	9,630.00
CLS29022E	Yellow	9,630.00
CLS29022F	Orange	9,630.00
CLS29022G	Assorted Color	9,630.00

Transfer Pipette

These one-piece, unbreakable polyethylene plastic pipettes are well-suited for blood banking (2 mL size), urinalysis, hematology, wet chemistry, microbiology, and serology.

- Bulk packed versions come in handy dispenser box
- Sterile versions available single wrapped, or 20 wrapped at a time
- Lot-to-lot traceability on sterile versions. All in packs of 500

Cat No	Description	Sterile	Length	Graduations	Overall Volume	Price
CLS20635E	0.5 mL, Bulk	No	60 mm	None	1.1 mL	8,000.00
CLS206371A	1 mL, Bulk	No	150 mm	0.25 mL	5 mL	4,500.00
CLS206371B	1 mL, 20/wrap	Yes	150 mm	0.25 mL	5 mL	8,600.00
CLS206371C	1 mL, 1/wrap	Yes	150 mm	0.25 mL	5 mL	12,880.00
CLS206372A	2 mL, Bulk	No	155 mm	0.5 mL	5 mL	4,700.00
CLS206372B	2 mL, 20/wrap	Yes	155 mm	0.5 mL	5 mL	8,600.00
CLS206372C	2 mL, 1/wrap	Yes	155 mm	0.5 mL	5 mL	12,900.00
CLS206373A	3 mL, Bulk	No	155 mm	0.5 mL	7 mL	4,700.00
CLS206373B	3 mL, 20/wrap	Yes	155 mm	0.5 mL	7 mL	9,200.00
CLS206373C	3 mL, 1/wrap	Yes	155 mm	0.5 mL	7 mL	13,500.00



Wire Tube & Bottle Racks

- Chemically-resistant epoxy-coated steel wire racks
- Suitable for conical, round or flat bottom glass or plastic tubes and bottles

Bijou Bottle/Tube Rack



- Rack suitable for Bijou bottles and low profile tubes up to 25 mm dia
- Available in a 2 x 6 or a 5 x 10 format
- Mesh bottom support

Universal Bottle/Tube Rack

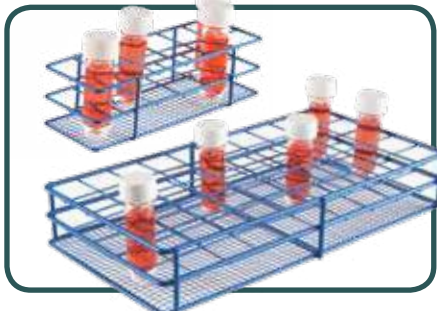

- Rack suitable for Universal, McCartney and Scintillation vials and low profile tubes up to 33 mm dia
- Available in a 2 x 6 or a 5 x 10 format
- Mesh bottom support

13 & 16 mm Tube Racks

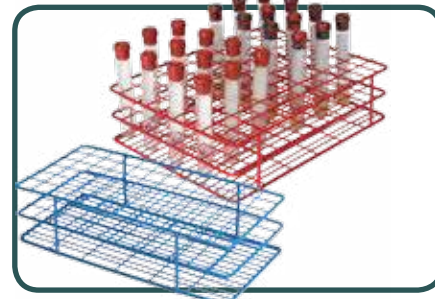

- For 13 and 16 mm blood collection tubes and test tubes
- Two formats for each size 6 x 12 and 9 x 12, color coded
- Slotted bottom

15 mL/50 mL Tube Racks



- Support capped tubes up to 18 mm dia 3 x 5 format
- Support capped tubes up to 30 mm dia 2 x 4 format
- Slotted bottom

Urine Container Rack

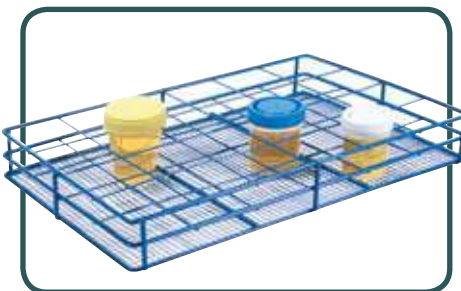

- Ideal for urine containers up to 58 mm dia
- Slotted bottom
- Mesh bottom support

Centrifuge Bottle Rack



- Holds bottles and vessels up to 60 mm dia
- Slotted bottom

Cat No	Description	Pack	Dimension mm	Price
CLS120085	Tube rack, blue, 25 mm well 2 x 6, 12 place		164 x 64 x 32 mm	4,350.00
CLS120086	Tube rack, blue, 25 mm well 5 x 10, 50 place		271 x 145 x 32 mm	7,610.00
CLS120087	Tube rack, blue, 33 mm well 2 x 6, 12 place		212 x 80 x 60 mm	4,350.00
CLS120088	Tube rack, blue, 33 mm well 5 x 10, 50 place		355 x 189 x 60 mm	8,200.00
CLS120089	Tube rack blue, 13 mm well, 6 x 12, 72 place		205 x 105 x 65 mm	6,850.00
CLS120090	Tube rack red, 13 mm well, 9 x 12, 108 place		205 x 162 x 65 mm	6,850.00
CLS23072	Tube rack blue, 16 mm well, 6 x 12, 72 place		237 x 127 x 65 mm	6,850.00
CLS23108	Tube rack red, 16 mm well, 9 x 12, 108 place		241 x 188 x 65 mm	6,850.00
CLS23215	Tube rack blue, 18 mm well, 3 x 5, 15 place		127 x 76 x 76 mm	6,800.00
CLS232461	Tube rack blue, 30 mm well, 2 x 4, 8 place		147 x 80 x 89 mm	6,700.00
CLS120091	Tube/Bottle rack blue, 58 mm well, 6 x 4, 24 place		393 x 262 x 50 mm	13,041.00
CLS23224	Bottle rack blue, 60 mm well, 2 x 3, 6 place		205 x 135 x 104 mm	6,161.00

Floating Foam Tube Racks

- Closed-cell foam resists water absorption so racks can be washed and reused
- Racks include detachable carrying handles-easily lift samples out of baths
- Pack of 5



Cat No	Tubes	Well	Color	Dimension	Price
CLS2165A	50 mL	4	Green	165 x 137 x 65	4,157.00
CLS2165B	15 mL	8	Blue	172 x 57 x 65	3,720.00
CLS2165C	1.5-2.0 mL	24	Yellow	150 x 83 x 69	4,230.00
CLS2166	0.2/0.5/ 1.5-2.0 mL	18	Blue	82 mm dia	4,300.00

Pearl™ Pipettes Adjustable Volume

- Internal metal parts for increased accuracy and calibration stability
- Easy volume adjustment with locking tab to prevent accidental change
- Separate tip ejector and a large digital volume display



Cat No	No of Channels	Volume Range	Price
CLS120097	Single	0.1–2 µL	40954
CLS120098	Single	0.5–10 µL	40954
CLS120099	Single	2–20 µL	40954
CLS120100	Single	5–50 µL	40954
CLS120101	Single	10–100 µL	40954
CLS120102	Single	20–200 µL	40954
CLS120103	Single	30–300 µL	40954
CLS120104	Single	100–1000 µL	40954
CLS120105	Single	500–5000 µL	40954
CLS120106	Single	1000–10000 µL	40954
CLS120215	Eight	5-50 µL	132600
CLS120216	Eight	30-300 µL	132600

Flip & Grip™ Pipette Holder

- Will hold up to 12 single channel pipette, or a combo of 3 single and 3 multichannel
- Holds most common brands. Rubber grips prevent scratching pipette



- Holder rotates for easy pipette selection and storage
- Weighted base. Fixing screw provided for under shelf option
- Measures 332 mm H x 193 mm W (bench top style); 187 mm L x 193 mm W (under shelf style)



Cat No	Color	Price
CLS120026	Blue	20,955.00
CLS120056	Lime	20,955.00
S120057	Magenta	20,955.00

Pipette Stands

These classic 3, 4, and 6-place pipette stands are designed to hold most major pipette brands.

- The upper slots are 25 mm and the lower slots are 20 mm wide
- Acrylic stands are transparent/clear; ABS stands are solid opaque colors



Cat No	Type	Material	Color	Price
CLS206203	Three	Acrylic	Clear	10,750.00
CLS206204	Four	Acrylic	Clear	12,132.00
CLS20620	Six	Acrylic	Clear	15,720.00
CLS20613C	Six	Acrylic	Blue	16,221.00
CLS20613E	Six	ABS	Blue	11,997.00

RF 1000 Pipette Controller

- Tapered silicon pipette adapter allows a large range of pipette sizes and makes to be used. Replaceable when worn
- Accepts common, and readily available replacement filters unlike other pipette aids whose filters are custom. This will help reduce total cost of ownership over time
- Includes a magnetic/wall mountable holder and 0.45 µm filter
- Overall dimensions 180 x 45 x 120 mm.



SPECIFICATIONS:

- Power: Manual
- Filter: PTFE/25 mm dia / 0.45 µm filter in PP housing
- Pipettes: 1 to 50 mL, glass and plastic
- Pipette nozzle: polypropylene, autoclavable
- Dimensions: 180 x 45 x 120 mm

Cat No	Description	Price
CLS1000RFU	RF1000 with magnetic/mountable holder	20046

RF 3000 Pipette Controller

- Operates with 110–240 volt electrical supplies worldwide
- Long-life Li-Ion Battery, with quick charge—up to 20 hours continuous use
- UV resistant housing—longer lasting when exposed to UV sterilizing
- Universal grip and soft coated triggers with direction indicators, for right or left handed users
- Ergonomically balanced in the hand with a loaded pipette
- Bright LEDs indicate three operation modes, High, Low and Gravity, toggled by repeatedly pressing a large mode button that is in easy reach of your thumb when in use
- Five different colored nose cones included to help differentiate department, task or user, as well as a labeling area on the side of the unit
- Filters are readily available, so you are not tied into a pipette specific brand—helps reduced the total life costs of ownership verses other makes of pipette aids
- An adapter can be fitted to the nose cone to stabilize small volume and thinner pipettes
- Low battery indicator; can be recharged when in use



Operational mode indicator



Magnetic wall mount



Specifications:

- Power: Rechargeable Li-Ion battery (replaceable)
- Filter: PTFE/25 mm dia 0.45 µm filter
- Pipettes: 1 to 100 mL, glass and plastic
- Pipettes nozzle: Polypropylene, autoclavable
- Dimensions: 15 x 152 x 41 mm

Rf3000 Package includes:

- Charging stand and wall-mountable/magnetic holder
- Nozzle adapter for use with small pipettes
- Li-Ion rechargeable battery
- Three replacement 0.45 µm filters
- Five nose cones, Blue, Lime, Shamrock, Teal, Lilac
- AC adapter 100 to 240V, 50/60Hz with four interchangeable plugs



Cat No	Description	Price
CLS3000	RF3000 with Power Adapter	78931
Replacement Parts:		
CLS5000RFFIL	Filters, Pack of 5	6,947.00
CLS300501	Universal Power Adapter	15,626.00
CLS3000RFRWH	Wall Mount Holder	6,874.00

HS300502	Battery RF3000	7,946.00
CLS5000RFRP	Pipette Adapter, Silicone	4,779.00
CLS300504	Nose Cones, Pack of 5	15,012.00

Vacuum/Pressure Bulb

- Pack of 2



Cat No	Capacity	Price
CLS20631B	85 mL	2,354.00

Multi-Channel Reagent Reservoirs



- Tapered reservoir bottoms into a narrow trough to aid full sample recovery

Cat No	Volume	Material	Sterility	Qrt	Price
CLS20521A	55 mL	Clear PVC	Non-Sterile	100/pk	11,456.00
CLS20521B	55 mL	White Polystyrene	Non-Sterile	100/pk	11,456.00
CLS20521C	55 mL	White Polystyrene	Sterile	50/pk	21,121.00
CLS20721B	100 mL	White Polystyrene	Non-Sterile	100/pk	14,159.00
CLS20721C	100 mL	White Polystyrene	Sterile	50/pk	31,427.00

Dual Solution® Reservoir

- Non-sterile. Pack of 25 reservoirs and 25 lids



Cat No	Description	Price
CLS20821A	Dual Solution Reservoir	20,515.00

Pipette Racks

Angled four shelved compartments keep your 0.1 to 50 mL pipettes or cans within easy reach while preventing damage and clutter.

- Heavy duty acrylic version provides crystal-clear viewing from any angle
- ABS versions have cut-out viewing window and come with two removable attachments that hold pipette bulbs, fillers, and pumps
- Magnetized ABS version has strong magnets on both sides and mounts securely to most metal surfaces*
- All racks measure 291 x 88 x 401 mm



Cat No	Description	Material	Color	Price
CLS20611	Pipette Rack	Acrylic	Clear	31,240.00
CLS20612	Pipette Rack	ABS	Blue	16,558.00
CLS20612M	Magnetized Pipette Rack	ABS	Blue	17,910.00
CLS20613	Pipette Rack	ABS	Red	16,560.00

Cargo™ Pipette Rack

Organize the Cargo™ Pipette Rack to meet your laboratory or personal needs. Click together horizontally or vertically to build the desired configuration, or use as individual holders, utilizing the three lid sections provided.

- Magnets on both sides of units connect securely and safely to most metal surfaces
- Angled shelves store 0.1 to 50 mL pipettes within arm's reach for use
- Protective lid encloses the unit to prevent dust build up and provides additional shelf space
- Link to additional sets for larger needs and requirements
- Assorted shades of blue: light, medium, dark. Pack of 3

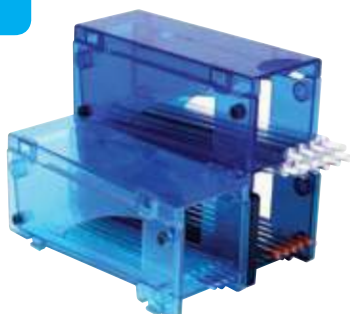

Cat No	Color	Dimension	Price
CLS20615M	Blue	301 x 100 x 127.5	17,840.00

Pipette Tip Disposal Box

Convenient for one-handed disposal of used pipette tips. Eliminates any need to handle pipette tips used with hazardous fluids.

- The 3/8" (10 mm) thick acrylic provides protection from Beta radiation
- The large, hinged lid allows easy disposal of contents
- Suggest using in conjunction with small Biohazard Disposal Bags (page 71), if hazardous fluids are not acrylic friendly
- Measures 154 x 171 x 206 mm.



Cat No	Description	Price
CLS234634	Pipette Tip Disposal Box	28,662.00

Rubber Pipette Filler

This rubber pipette filler is designed for efficient one-handed operation. Control air evacuation, liquid uptake, and liquid dispensing with three valves, each containing a chemical-resistant stainless steel ball.

- Pinch release valve for smooth liquid flow
- Filler its standard size pipettes
- Order the red pipette filler for safe pipetting of caustics. It does not contain carbon black and will not smudge
- Filler measures 54 x 54 x 130 mm

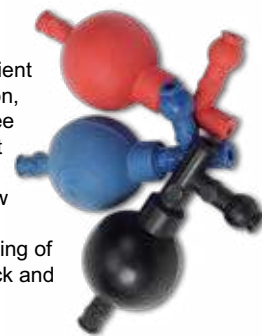

Cat No	Description	Price
CLS20632A	Pipette Filler, Black	1,636.00
CLS20632B	Pipette Filler, Red	1,636.00
CLS20632C	Pipette Filler, Blue	1,636.00

Safety Bulb Pipette Filler

- Pack of 3



Cat No	Capacity	OD	Price
CLS20623	15 mL	41 mm	3,620.00

Latex (Natural Rubber) Dropper Bulbs

- Pack of 72



Cat No	Capacity	Length	OD	Hole Die	Price
CLS20622A	1 mL	43 mm	13 mm	5 mm	6,450.00
CLS20622B	2 mL	52 mm	13 mm	6 mm	6,450.00

Cardboard Slide Tray



Cat No	Capacity	Trim/imprinting	Dimension	Qty.	Price
CLS9902	20-Place	Black	208x341x9	72/cs	88322
CLS9913	20-Place	Blue	208x341x9	72/cs	88322
CLS9914	20-Place	Green	208x341x9	72/cs	88322
CLS120196	20-Place	Red	208x341x9	72/cs	88322
CLS120197	20-Place	Yellow	208x341x9	72/cs	88322
CLS9930	30-Place	Black	281x328x10	40/cs	85067

Cardboard Slide Mailers

1-Place



Cat No	Capacity	Dimension	Qty	Price
CLS9903	1-Place	95 x 42 x 5 mm	25/pk	5,050.00
CLS9904	2-Place	103 x 79 x 5 mm	36/pk	10,731.00

Plastic 5-Slide Mailers

Pack of 25



Cat No	Description	Color	Dimension	Price
CLS15982	Side-Opening Mailer	Natural	226 x 340 x 125	3,100.00
CLS15983G	End-Opening Mailer	*		3,100.00
CLS15986	End-Opening Mailer	Natural		3,041.00

Rubber Bulbs

• Pack of 1



Cat No	Capacity	Length	OD	Hole Die	Price (₹)
CLS20630B	15 mL	56 mm	34 mm	4 mm	534.00
CLS20630C	30 mL	66 mm	46 mm	6 mm	671.00
CLS20630D	60 mL	80 mm	54 mm	6 mm	790.00
CLS20630E	150 mL	103 mm	73 mm	6 mm	2,354.00

20-Place Slide Tray Racks

Search, identify, and easily locate the specimen slide you need!

- ABS rack holds five 20-place slide trays (not included see above)
- Eliminates the worry of breakage during retrieval-easy access to each of the trays
- Matching clasps provide area for identification labels and doubles as a handle



Cat No	Capacity	Color	Dimension	Price
CLS99040A	5 Slide Trays	Black	226 x 340 x 125	9,193.00

Plastic 2-Place Slide Mailer

- Measures 93 x 68 x 5 mm.
Pack of 25

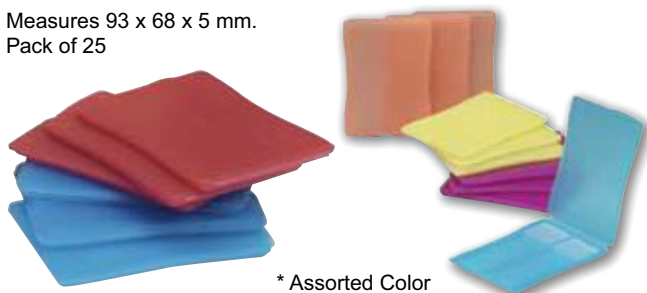

* Assorted Color

Cat No	Description	Color	Dimension	Price
CLS15983A	2-Place Slide Mailer	*	226 x 340 x 125	3,030.00
CLS15983B	2-Place Slide Mailer	Natural		3,030.00

Slide Staining Tray Set

- Pack of 4 base trays and 1 lid
- Stain, rinse, and dry slides on a single working tray
- Made from a polypropylene and polyethylene blend
- A clean and fresh working surface area every time
- Up to eight slides it comfortably onto the base and the deep well holds up to 38 mL
- Compact size and recessed handles for easy transport from work area to sink
- Two convenient pour spouts for quick disposal of unwanted liquid waste
- Dark lid protects slides for light sensitive applications
- Pack of 4 base trays and 1 lid
- Disposable



Cat No	Description	Dimension	Price (₹)
CLS15951A	8 slides	305 x 127 x 29.5 mm	9,062.00

Slide Holder

Hold slides during evaluation, cleaning, and drying

- Made from chemical-resistant polyethylene
- Solid, strong construction with rubber feet for bench top stability

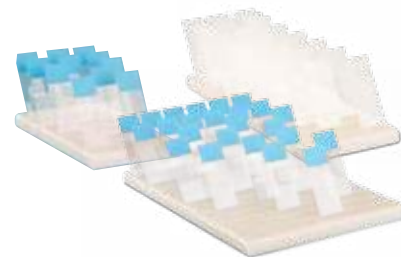

Cat No	Description	Dimension	Price
CLS15981C	15	153 x 102 x 21 mm	9,327.00
CLS15981A	40	298 x 105 x 24 mm	10,037.00
CLS15981B	78	299 x 178 x 21 mm	12,506.00

Tungsten-Point Lab Pen

Cat No	Description	Price
CLS1846	Tungsten-Point Lab Pen	9,196.00



- Ideal for forensic, life science, agricultural, industrial and safety investigations to name a few
- Base measures 89 x 127 mm. Bendable neck and head measure 559 mm

Cat No	Description	Price (₹)
CLS15941B	Flexible Digital Microscope	76222

Handheld Digital Microscope

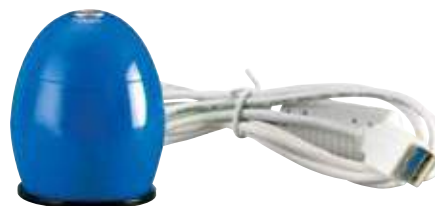

- Use with a computer or projector
- Uploads and charges via USB. Software compatible with Microsoft Windows® (98SE/2000/ME/XP/Vista/7), Mac OS® X 10.4. Computer with monitor required for use (not included)
- Up to 43x magnification using a 17" monitor (up to 53x using a 21" monitor)
- High-quality resolution with 640 x 480 pixels (1280 x 960 Mac). Direct x 9.0 or above required for Windows OS, VGA CMOS sensor
- 15 frames per second with auto white balance and auto exposure 2 head adapters for viewing different media (included)
- 4 LED lights illuminate dark settings or objects
- Removable pieces for easy cleaning. Simple plug and play functionality
- Measures 44 mm dia; 64 mm H

Cat No	Description	Price
CLS15941A	Handheld Digital Microscope	38106

Microscope Slide Dispenser

Cat No	Description	Price
CLS15984	Slide Dispenser	4,021.00



Lens Tissue Books

Non-abrasive cleaning for delicate optical surfaces Lint-free i ber paper is ideal for cleaning lens and optics.

- Pack consists of 20 books of 100 sheets. (4 inner packs of 5 books)



Cat No	Description	Price
CLS15920	Lens Tissue Books	36,361.00

Flexible Digital Microscope

Easy-to-use microscope connects to any PC and provides high-quality images from 10x to 200x magnification.

- Bendable gooseneck positions easily to view hard-to-see objects
- Built-in camera and microphone provide immediate assessment
- Use with a projector or PC. Charges and uploads via computer USB port
- Features true 1.3 MP resolution, 15 fps frame rate, focus wheel, 6 LED lights and measurement software (compatible with Windows XP®, Windows Vista®, Mac OS® 10.6 and above). Direct X 9.0 required
- Computer with monitor required for use (not included)
- Portable and ideal for investigating flat or 3D subject matter especially items often difficult to see round or behind



Tall Slide Box 100-Place

Sturdy ABS material for rugged use. Slide boxes are designed for storage and transport.

- Grooved slots hold individual slides in place
- Soft cork lining ensures that slides will not slip
- Identification card, lining and grooved slots are numbered
- Stackable with other Tall boxes and/or 100-place Premium slide boxes



Cat No	Capacity	Color	Dimension	Price
CLS15979A	100	Blue	208 x 175 x 60 mm	4,905.00

Standard Microscope Slide Boxes

Constructed of durable polypropylene, slide boxes hold either 25 or 100 standard slides (25 x 75 mm and 1 x 3").

- Stacking feet maximize stability
- Slide Identification card. No liner
- 25-place box measures 141 x 92 x 3 mm; 100-place box measures 210 x 169 x 37 mm



Cat No	Capacity	Color	Price
CLS15990A	25-Place	Blue	946.00
CLS15990B	25-Place	Red	946.00
CLS15990C	25-Place	White	946.00
CLS15991A	100-Place	Blue	1,284.00
CLS15991B	100-Place	Red	1,284.00
CLS15991C	100-Place	White	1,284.00



25-Place Slide Boxes

100-Place Slide Boxes

Color	Cat (cork-lined)	Price	Cat (cork-lined)	Price
Blue	CLS15994A	1,877.00	CLS15994M	2,215.00
Green	CLS15994B	1,877.00	-	-
Red	CLS15994C	1,877.00	CLS15994P	2,215.00
Yellow	CLS15994D	1,877.00	-	-
White	CLS15994E	1,877.00	CLS15994R	2,215.00
Grey	CLS15994F	1,877.00	-	-
Black	CLS15994G	1,877.00	-	-

True North® Microscope Slide Box

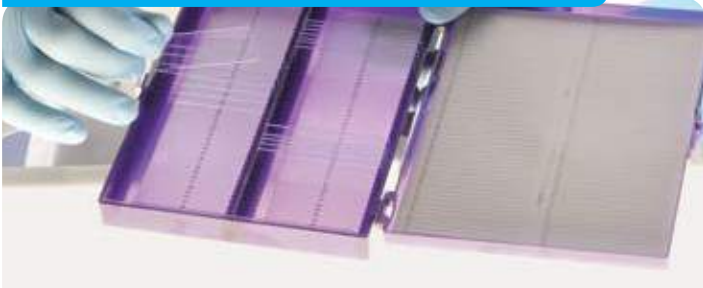

Cat No	Color	Slides	Price
CLS15988H	Purple	100	4,905.00

50-Place Slide Boxes

Color	Cat (cork-lined)	Price
Blue	CLS15996A	1,791.00
Red	CLS15996B	1,791.00
White	CLS15996C	1,791.00

25-Place Slide Boxes

Color	Cat (cork-lined)	Price (₹)	Cat (cork-lined)	Price
Blue	CLS15989A	1,623.00	CLS15989M	1,690.00
Green	CLS15989B	1,623.00	-	-
Red	CLS15989C	1,623.00	CLS15989P	1,690.00
White	CLS15989E	1,623.00	CLS15989R	1,690.00

Premium Microscope Slide Boxes

- Molded, rigid boxes securely hold slides in grooved slots
- Durable ABS plastic boxes are available with either cork or foam lining
- Both the lining and the slots are numbered to correspond to the slide inventory sheet
- [Pack size 1](#)

50-Place Slide Boxes



100-Place Slide Boxes

Storage Rack for Microscope Slide Boxes



Cat No	Bins	Dimension	Price
CLS159890B	15	711 x 171 x 228 mm	81,103.00

Sample Collection Cart

- Made of durable stainless steel and aluminum construction
- Handle for pulling the unit
- Painted surfaces utilize Microban® protection
- 5 wheel, weighted base for stability of unit
- Designed to hold the Droplet™ blood collection station
- Adjustable height – Range: 30 tp 55 inches (762 x 1397 mm)
- Designated tray area dimensions 16 x 9 x 6 inches (429 x 265 x 172 mm)
- Working surface dimensions 14.25 x 7.5 inches (362 x 191 mm)



Cat No	Dimension	Price
CLS120263	Sample Collection Cart 1	2,57,400.00
CLS120264	Deluxe Sample Collection Cart 2	3,58,280.00

Blood Collection Tray

Lightweight, roomy and easy-to-clean Droplet™ Blood Collection Tray. Keeping a clean and organized tray has never been easier. Wash the ABS tray as needed, and replace the insert periodically for a fresh start. Tray inserts come in two configurations and include an extra-deep compartment for a sharps container on the following page.



- Tray features a supply drawer, side pockets, and a ratcheting handle with soft rubber grip that rotates out of the way for easy access
- Each tray includes either a 13 mm or a 16 mm Heathrow OneRack® test tube rack and two disposable polystyrene inserts
- Additional inserts sold in packs of 4 in two different configurations

Cat No	Dimension	Price
CLS2200A	Droplet Blood Collection Tray with 2 Inserts (Style A) and a 36-Place, 13 mm Test Tube Rack	24,297.00
CLS2200B	Droplet Blood Collection Tray with 2 Inserts (Style B) and a 36-Place, 16 mm Test Tube Rack	24,297.00

Droplet™ Lid

Protect the contents of the Droplet Tray with this sturdy lid. Custom designed for a snug fit, the lid provides access to the tray handle in its vertical position.

- Can be secured with cable ties for extra security
- Made of polystyrene



Cat No	Color	Price
CLS2202	White	13,552.00

Disposable Droplet inserts



Insert A for 13 mm tube rack

Insert B for 16 mm tube rack

Cat No	Color	Price
CLS2201A	Insert A for 13 mm Tube Rack, Pack of 4	7,097.00
CLS2201B	Insert B for 16 mm Tube Rack, Pack of 4	7,097.00

Sharps Containers

Provides safe disposal of syringes, needles and other small sharps. Stackable to reduce storage space before use



- 1.0 L capacity (Quart) with a clear lid to view fill level
- Slide access lid for temporary and final closures for safety and security
- Built-in needle removal port, preventing direct contact with sharps
- Measures 115 W x 115 D x 192 H mm, packs of 18

Cat No	Description	Color	Price
CLS120177	1.0 L sharps container	Yellow	18,210.00
CLS120178	1.0 L sharps container	Red	18,210.00

X-tourn™ Tourniquets

High-quality disposable tourniquets that will not rope or curl when being used, so you can rely on the performance of every one. Latex free, no rubber proteins, resins or fatty acids that can produce hypersensitive reactions.



- Made from supple and smooth polyisoprene
- Less abrasive than other brands, uniform thickness prevents shredding and breaking
- Each measures 2.54 x 45.72 cm

Cat No	Capacity	Color	Pack	Price
CLS120108	Tourniquets	Green	100/pk	8,271.00
CLS120109	Tourniquets	Green	25/roll	3,860.00
CLS120110	Tourniquets	Orange	250/pk	19,300.00
CLS120111	Tourniquets	Orange	25/roll	3,860.00

ToteMax™ Blood Collection Trays

Unique phlebotomy tray design and patented hook feature allows the tray to be on or over most bed rail, footboard and handrails outside a typical patient room. Made from food grade resins for a durable non-breakable design



Cat No	Color	Price
CLS120021	Blue/Red/Pink/Purple/Green	23,160.00

Blood Collection Tray

- Customize the compartments to suit your personal needs with dividers provided.
- Lightweight easy-to-clean ABS construction
- Comfort grip handle tested to hold up to 10 Kg!



Cat No	Description	Tube Rack	Price
CLS120261	Blood Collection Tray, White	17 mm rack	36,956.00

Droplet® Sample Storage Tray

Hard wearing storage trays that can be used for specimen containers with the insert provided, or for general lab products without the insert.

- Lightweight and sturdy to hold up to 24 full specimen containers (up to 58 mm in diameter). Specimen containers not included.
- Removable insert to allow outer shell to be used for storage or transportation of laboratory products

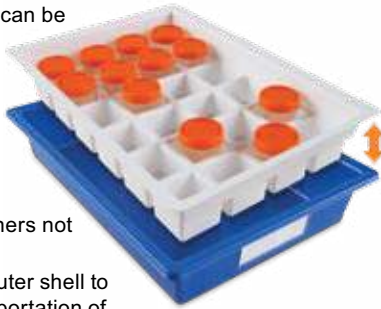

Cat No	Description	Color	Price
CLS120172	Droplet® Sample Storage Tray		15,532.00

Urine Container Rack

- Chemically-resistant epoxy-coated steel wire racks
- Suitable for 1 at bottom containers up to 58 mm dia
- Slotted bottom
- Mesh bottom support

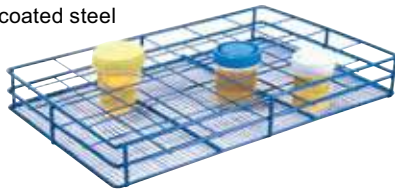

Cat No	Description	Dimension	Price
CLS120091	Tube/Bottle rack blue, 58 mm well, 6 x 4, 24-place	393 x 262 x 50 mm	13,041.00

Bouffant Head Covers

Latex-free bouffant head covers, designed for roominess and comfort. Gentle elastic provides secure coverage without binding. Made of comfortable SPP (spunbond polypropylene).



Cat No	Description	Color	Pack	Price
CLS120058	Bouffant Head Cover 24"	Blue	Pk/100	8,247.00

Shoe Cover

Slip resistant, Latex Free
Made of strong, low-linting polypropylene, slip-resistant tread



Cat No	Description	Color	Pack	Price
CLS120059	Shoe Cover, Slip Resistant, PP	Blue	Pk/100	17,087.00

Clamp-Ette® Pipette Holders

- Chemical-resistant polypropylene and its most major pipette brands.
- Available in a single or triple format



Cat No	Description	Color	Price
CLS2062A	Clamp-Ette	Blue	3,839.00
CLS20162A	Tri Clamp-Ette	Blue	8,450.00

Benchtop Counters

Mechanical, benchtop counters are perfect for blood cells (label included), bacterial colonies or other repetitive counting.

- Each key records up to 999
- Total window keeps track of total number of strokes made on all other keys; bell rings when total reaches 100



Blood cell key labels

- CLS5360A: Baso., Eosin., Mono., Lymph., Poly., and Total, measures 250 x 76 x 56 mm
- CLS5360B: Baso, Eosin., Myelo., Juven., Stab., Seg., Lymph., Mono., and Total, measures 320 x 76 x 56 mm

Cat No	Description	Dimension	Price
CLS5360A	6-Key Benchtop Counter	250 x 76 x 56	81,696.00
CLS5360B	9-Key Benchtop Counter	320 x 76 x 56	118,335.00

Arctic Squares® Freezer Rack

Inovative horizontal drawer system for upright freezers

Constructed of corrosion-resistant stainless steel with four drawers to hold 16 boxes.

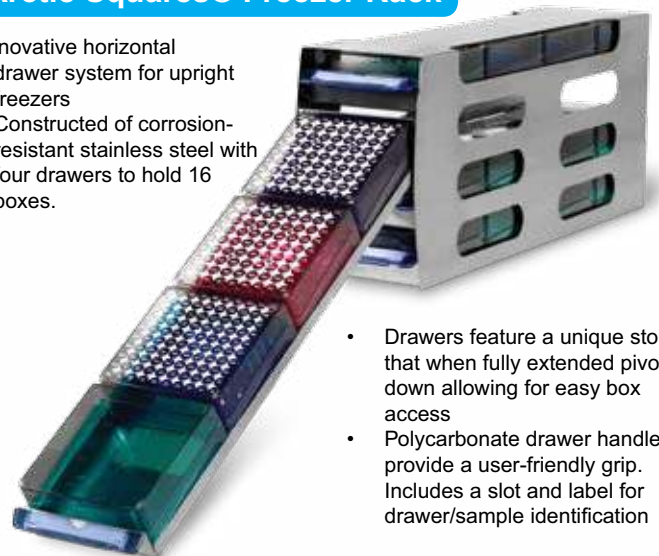

- Drawers feature a unique stop, that when fully extended pivot down allowing for easy box access
- Polycarbonate drawer handles provide a user-friendly grip. Includes a slot and label for drawer/sample identification

Cat No	Orientation	Capacity	Shelves	Box Height	Dimension	Price
CLS2864	Horizontal	16 Boxes	4	53 mm	139 x 571 x 238	78,709.00

Assay Plate Freezer Rack

For Assay Plate and PCR® rack storage in upright freezers



Conig	Cat No	Open (Dimension)	Overall (Dimension)	Price
4 x 4	CLS28624	135 x 111 x 56 mm	543 x 112 x 230 mm	41,886.00

Cube Freezer Rack - Upright

For 15 and 50 mL tube box storage
Constructed of corrosion-resistant stainless steel with 6 (2 x 3) rack spaces.



Conig	Cat No	Box Size	Dimension	Price
2 x 3	CLS28622	152 x 157 x 134	459 x 159 x 271	40,839.00

Cube Freezer Rack - Chest

For 15 and 50 mL tube box storage
Constructed of corrosion-resistant stainless steel with 4 (4 x 1) rack spaces.



Conig	Cat No	Box Size	Dimension	Price
4 x 1	CLS28621	152 x 156 x 133	154 x 157 x 539	19,372.00

Freezer Racks

Upright Freezer Rack Configurations



Chest Freezer Rack



Chest Freezer Racks

Conig	Cat No	Box Size	Dimension	Price
7 x 1	CLS2862AB	2" (53 mm)	140 x 141 x 390	22,618.00
10 x 1	CLS2862A	2" (53 mm)	140 x 141 x 557	21,654.00
11 x 1	CLS2862AC	2" (53 mm)	140 x 141 x 613	27,975.00
12 x 1	CLS2862AD	2" (53 mm)	140 x 141 x 669	29,761.00
13 x 1	CLS2862AE	2" (53 mm)	140 x 141 x 724	30,952.00
5 x 1	CLS2862DA	3" (75 mm)	140 x 141 x 406	20,833.00
8 x 1	CLS2862D	3" (75 mm)	140 x 141 x 649	20,341.00
9 x 1	CLS2862DB	3" (75 mm)	140 x 141 x 730	27,975.00

Upright Freezer Racks 2" boxes

Conig	Cat No	Box Size	Dimension	Price
4 x 3	CLS2862HA	2" (53 mm)	418 x 140 x 225	35,559.00
4 x 4	CLS2862H	2" (53 mm)	556 x 140 x 225	37,848.00
4 x 5	CLS2862HD	2" (53 mm)	695 x 140 x 225	51,784.00
5 x 3	CLS2862HE	2" (53 mm)	418 x 140 x 280	37,499.00
5 x 4	CLS2862HB	2" (53 mm)	556 x 140 x 280	51,784.00
7 x 4	CLS2862HC	2" (53 mm)	556 x 140 x 392	60,713.00

Upright Freezer Racks 3" boxes

Conig	Cat No	Box Size	Dimension	Price (₹)
3 x 3	CLS2862KA	3" (75 mm)	418 x 140 x 245	34,523.00
3 x 4	CLS2862K	3" (75 mm)	556 x 140 x 245	36,746.00
4 x 4	CLS2862KB	3" (75 mm)	556 x 140 x 326	49,999.00
5 x 4	CLS2862KC	3" (75 mm)	556 x 140 x 407	57,141.00

Slide Box Freezer Rack

For slide boxes, Reversible PCR® and 50-Well EPS racks in upright freezers



Conig	Cat No	Box Size	Dimension	Price
3 x 3	CLS28623	180 x 212 x 73	541 x 217 x 221	56,022.00

Cryogenic Vial Holders

- Well tabs allow one-handed opening and closing of vials that have a slot feature
- Embossed index numbers and squared, upper left corner provide easy orientation
- Ribbed grips make handling with gloves easier



Pack of 4

Cat No	Wells	Color	Price
CLS23229B	50	Blue	21,121.00

Arctic Squares® Polycarbonate Cryostorage Boxes

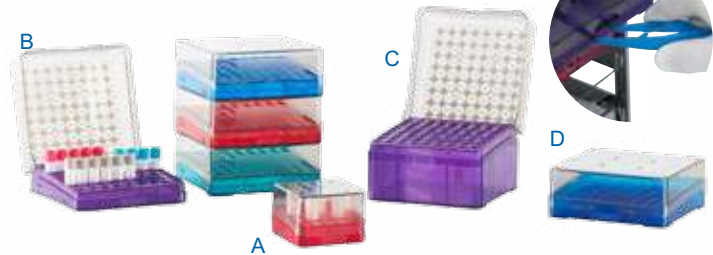

Safely store vials from -196 to +121°C in mechanical freezers as well as liquid nitrogen! Our polycarbonate boxes are designed with unique features to help orient, identify and access vials with ease.

- Hinged lid with built-in stop allows easy one-handed access to samples (not on 25 place)
- Forward-sloped base and high contrast indexing on the transparent lid ensure quick visual orientation
- Magnetic tipped forceps supplied with styles B, D, E and F. Help pick vials and remove boxes from freezer racking
- All boxes have vent and drainage holes, are stackable and autoclavable

Cat No	Description	Base Color	Vial Size	l x m x h ml	Qty	Price
CLS23325A	5 x 5 Array Boxes	Ruby Red	up to 2.0	76 x 76 x 53	8/pk	14,484.00
CLS23381B	9 x 9 Array Standard Boxes	Assorted Color	up to 2.0	133 x 133 x 53	4/pk	11,845.00
CLS23381C	9 x 9 Array Tall Boxes	Amethyst Purple	up to 5.0	133 x 133 x 96	5/pk	18,443.00
CLS23300D	10 x 10 Array Boxes	Arctic Blue	up to 5.0	133 x 133 x 53	4/pk	11,845.00

PVC Cryogenic Cane Sleeves

- Clear plastic sleeves protect vials in aluminum canes during handling and storage
- Safe for cryogenic freezing
- More durable than cardboard sleeves
- Transparency allows sample identification without removing sleeve
- Measure 14.5 mm dia x 275 mm long. Pack of 100

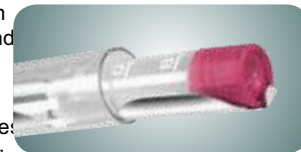

Cat No	Description	Price
CLS23210	Clear Cane Sleeves	17,572.00

Cryogenic Vial Canes



Aluminum canes hold vials for freezer storage or immersion in L₂N dewars.

- For use in liquid and vapor phase; use approved vials only
- Canes bend to fit all major cryogenic vial brands. Pack of 12

Cat No	Length	No of Vials	Vials Size	Price
CLS23205	290 mm	5	up to 2.0 mL	5,576.00
CLS23206	300 mm	6	up to 5.0 mL	5,576.00

Mini Coolers

Ideal for keeping PCR® reagents, enzymes, and other biochemical reagents cool while working at the bench. Filled with insulating gel, the Mini Coolers can also be used for controlled sample freezing and for longer temperature retention samples.

- Polycarbonate construction with rubber non-slip feet
- Gridded and keyed one-position lids for easy sample identification
- 0.5 mL tube adapters supplied as standard with the 0.5–2.0 mL tube size versions
- Temperature-retention graph supplied with each of the 7 styles
- Versions available for 0.5 and 1.5/2.0 mL microcentrifuge tubes and cryogenic vials and a 96-place version for 0.2 mL tubes and assay plates

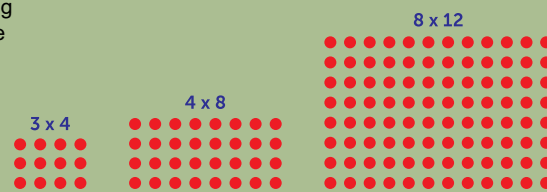

Cat No	Temp	Tube Array	No. Tubes	Tube Sizes	Color	Lid	Dimensions (mm)	Temp Retention	Price
CLS120070	0°C	3 x 4	12	0.5–2 mL	Green	Clear	145 x 105 x 100	1°C for 4 hr**	35,493.00
CLS120071	0°C	4 x 8	32	0.5–2 mL	Green	Clear	245 x 105 x 100	1°C for 5 hr**	60,065.00
CLS120072	0°C	4 x 8	32	0.5–2 mL	Green	Gel Filled	245 x 105 x 100	1°C for 7.5 hr**	65,526.00
CLS120073	-20°C	3 x 4	12	0.5–2 mL	Blue	Clear	145 x 105 x 100	-15°C for 2.5 hr**	35,493.00
CLS120074	-20°C	4 x 8	32	0.5–2 mL	Blue	Clear	245 x 105 x 100	-15°C for 3.5 hr**	60,065.00
CLS120075	-20°C	4 x 8	32	0.5–2 mL	Blue	Gel Filled	245 x 105 x 100	-15°C for 5 hr**	65,526.00
CLS120076	-20°C	8 x 12	96	0.2 mL	Blue	Clear	225 x 165 x 110	-15°C for 3.5 hr	65,526.00

Cool Containers

Conveniently nest lid beneath bucket or pan

- The close-it lid keeps evaporation to a minimum and features a comfortable recessed knob
- The lid and bottom of the bucket/pan are keyed to it together
- For low-temperature use to -196°C at 1 bar
- Taper design for easy stacking
- Precise pour spout and generous handles
- In four, color-coded, user-friendly sizes



Cat No	Shape	Size	Thickness	Qty	Price
CLS28714K	Bucket	4 L	181 (H) x 234 (D)	Black Onyx	24,410.00
CLS28721G	Pan	1 L	267 x 195.5 x 114	Emerald	17,780.00
CLS28724B	Pan	4 L	381 x 254 x 140	Arctic Blue	26,976.00
CLS28729R	Pan	9 L	521 x 292 x 163	Ruby	36,509.00

Freezer Thermometer

Protect frozen and chilled samples from potential spoilage. Monitor temperatures inside your freezer or refrigerator with the added convenience of sound and flashing LED lights to alert out-of-range temperatures.



- Suction cup attaches the probe inside freezer/refrigerator while the thermometer secures to the outside with hook-and loop tape
- Large digital display shows freezer/refrigerator temperature plus ambient temperature
- Set freezer range: 14.9° to -9.4°F (-9.5° to -23°C); set refrigerator range: 35.6° to 46.4°F (2° to 8°C)
- Switches toggle for freezer or refrigerator monitoring and °F or °C
- Includes one AAA battery
- Unit measures 136 x 19 x 28 mm; probe cable measures 0.9 m; probe measures 5 mm OD x 17 mm L

Cat No	Color	Price
CLS28630	Freezer Thermometer	8565

smartSPATULAS®

Ideal for keeping PCR® reagents, enzymes, and other biochemical reagents cool while working at the bench. Filled with insulating gel, the Mini Coolers can also be used for controlled sample freezing and for longer temperature retention samples.



- Polycarbonate construction with rubber non-slip feet
- Gridded and keyed one-position lids for easy sample identification
- 0.5 mL tube adapters supplied as standard with the 0.5–2.0 mL tube size versions
- Temperature-retention graph supplied with each of the 7 styles
- Versions available for 0.5 and 1.5/2.0 mL microcentrifuge tubes and cryogenic vials and a 96-place version for 0.2 mL tubes and assay plates

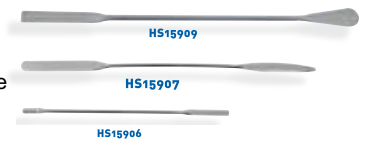

smartSPATULAS® autoclavable

Cat No	Description	use with tubes	Qty.	Price
CLS120005	Micro Antistatic	0.2 mL	300/pk	7,171.00
CLS120008	Eco	15 and 1.5 mL	300/pk	10,748.00
CLS120003	Standard Blue	15 and 1.5 MI	300/pk	10,124.00
CLS120004	Standard Opaque	15 and 1.5 mL	300/pk	10,124.00
CLS120007	Std. Opaque Sterile	15 and 1.5 MI	300/pk	40,954.00
CLS120006	Macro Green	50 mL	150/pk	11,226.00

smartSPATULAS® autoclavable

Cat No	Description, mm	l, mm	Finish	Price
CLS15906	Flat end, 30 L; spoon, 12 L x 4 W	150	Glazed	1,014.00
CLS15907	Round lat end, 50 L x 8 W Tapered Flat end, 45 L x 6.5 W	195	Mirror	1,014.00
CLS15909	Flat end, 50 L; spoon, 38 L x 15 W	225	Mirror	1,081.00

Forceps

Disposable forceps feature corrugated handles and serrated tips. ABS. Pack of 6.



Cat No	Length	Tip	Color	Price
CLS15998C	111 mm	Straight	Dark Blue	4021

Weighing Dishes

Pack of 100



Color	Size	Dimension mm	Regular Material	Price
Aluminum	Small	43 dia x 12 H	CLS14521A	1,654.00
	Medium	57 dia x 14 H	CLS14521B	1,860.00
	Large	70 dia x 16 H	CLS14521C	2,549.00
G Aluminum	Large	101 dia x 8 H	CLS14522	3,238.00

Weighing Boats

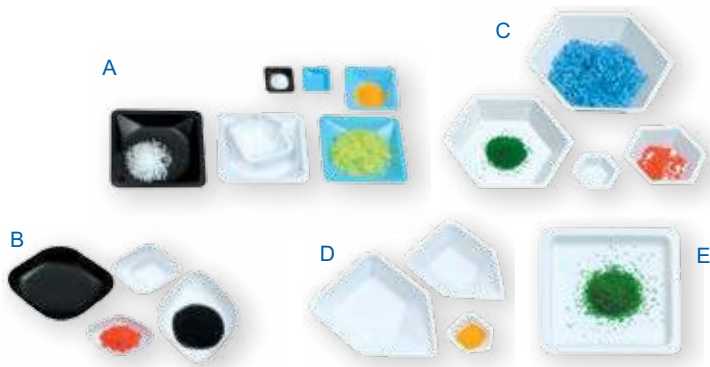

- A. Standard Weighing Boats
- B. Diamond-Shaped Weighing Boats
- C. Hexagonal Weighing Boats
- D. Pour-Boat Weighing Dishes
- E. Square Weighing Boats

Pack of 500

Color	Size	Dimension mm	regular material	Price (₹)	antistatic material	Price
White Blue Black	Small	46 x 46 x 8	CLS1420A	3281.00	CLS1420AA	5,750.00
	Medium	85 x 85 x 24	CLS1420B	5256.00	CLS1420BB	9,000.00
	Large	140 x 140 x 22	CLS1420C	8988.00	CLS1420CC	14,434.00
B White Black	5 mL	55 x 35 x 6	CLS1424AA	2724.00	CLS1425AA	4,375.00
	25 mL	71 x 46 x 14	CLS1424A	4505.00	CLS1425A	7,751.00
	30 mL	78 x 56 x 14	CLS1424B	4505.00	CLS1425B	7,751.00
	100 mL	119 x 90 x 19	CLS1424C	9417.00	CLS1425C	15,812.00
C White	Small	38 x 25 x 9	N/A		CLS14251A	3,686.00
	Medium	64 x 51 x 19	N/A		CLS14251B	6,545.00
	Large	102 x 76 x 22	N/A		CLS14251C	18,086.00
	X-Large	127 x 89 x 31	N/A		CLS14251D	23,081.00
D White	Small	43 x 58 x 13	CLS1419A	8,612.00	CLS120225	9,157.00
	Medium	83 x 132 x 26	CLS1419B	17,879.00	CLS120226	18,528.00
	Large	108 x 183 x 26	CLS1419C	27,525.00	CLS120227	28,647.00
E White	Medium	90 x 90 x 7	CLS1422	9,129.00	N/A	

Wash Bottles Safety Labeled Self Venting

- Wide bottle mouth makes filling easier
- Non-metallic vent that prevents the risk of solvent leakage
- With the exception of the bottle designed for Sodium Hypochlorite, which is a white LDPE bottle for light protection and has a HDPE closure, the bottles are made from LDPE, with a PP closure
- Six named chemicals, a self labeling** and assorted pack of bottles to choose from
- 500 mL bottle size, supplied in packs of 6



Cat No	Description	Color	Price
CLS120250	Acetone	Red	10,910.00
CLS120251	Distilled Water	Natural	10,910.00
CLS120252	Isopropanol	Yellow	10,910.00
CLS120253	Ethanol	White	10,910.00
CLS120254	Methanol	Green	10,910.00
CLS120255	Sodium Hypochlorite	Blue	10,910.00
CLS120256	Self labeling**	Natural	10,910.00
CLS120257	Assorted*		10,910.00

Wash Bottles Color-Coded

- Wide bottle mouth makes filling easier
- Non-metallic vent that prevents the risk of solvent leakage
- With the exception of the bottle designed for Sodium Hypochlorite, which is a white LDPE bottle for light protection and has a HDPE closure, the bottles are made from LDPE, with a PP closure
- Six named chemicals, a self labeling** and assorted pack of bottles to choose from
- 500 mL bottle size, supplied in packs of 6



Cat No	Color	Price
CLS120245	White	6,670.00
CLS120246	Red	6,670.00
CLS120247	Yellow	6,670.00
CLS120248	Green	6,670.00
CLS120249	Blue	6,670.00

Weighing Papers

- Nitrogen-free for a very smooth surface and good sample recovery
- Strong enough to support dense material
- Available in 3 sizes



Cat No	Dimensions	Qty.	Price
CLS120116	3 x 3" (76.2 x 76.2 mm)	500/pk	7,688.00
CLS120117	4 x 4" (101.6 x 101.6 mm)	500/pk	11,348.00
CLS120118	6 x 6" (152.4 x 152.4 mm)	500/pk	22,729.00

Eyewash Stations

- Frame is equipped with top and bottom holes for easy mounting to any lat surface. Screws provided
- Each station includes attached mirror, instruction cards, and one or two 1 L (32 oz) dousing bottles



Cat No	Description	Bottles	h x w x d, mm	Price
CLS1019B	Single Bottle Eyewash Station	One 32 oz (1 L)	425 x 167 x 105	6,725.00
CLS1020B	Double Bottle Eyewash Station	Two 32 oz (1 L)	425 x 355 x 105	10,780.00
CLS1021B	Replacement Bottle	32 oz (1 L)	86 dia x 275 H	2,197.00

Transport Box

- Polycarbonate construction and available in three colors for user/owner identification
- Silicone water-tight seal and three lid clasps provide secure closure
- Carry handle folds neatly into body space allowing the units to be stacked
- Lid opens a full 180°, allowing total access to contents and making it easier to clean
- Use the separators provided to create your own compartment sizes, or use empty to transport larger products and equipment
- Autoclavable and measures 380 x 196 x 160 mm



Cat No	Color	Price
CLS120052	Clear with Blue handles	23,160.00
CLS120077	Red with Red handles	23,160.00
CLS120078	Yellow with Yellow handle	23,160.00

Grabbit™ Temp Mitts

- Oversized surfaces with nubs for secure grip
- Mitts withstand temperatures from -70 to 500°F (-57 to 260°C)



Cat No	Description	Dimension, mm	Price
CLS1034A	Full-Hand Mitt	177 x 100 x 32	4,596.00

High-Temperature Gloves

- Maintain flexibility and comfort in most applications
- Two sizes available; wrist length and forearm length
- Machine washable



Cat No	Gauntlet	Overall Length	Price
CLS1031B	250 mm	485 mm	9,631.00

Bottle Carrier

- Made from 304 grade Stainless Steel, with a wire mesh bottom for increased stability
- Handles fold down for easier storage
- Autoclavable and measures 370 x 180 x 380 mm with handles extended



Cat No	Dimension	Price
CLS120092	CLS 120092 370 x 180 x 380 (with handles extended)	13,584.00

Laboratory Safety Razor Blade

- Cleanly slice agarose gels* right on the light box without scratching the surface
- Ideal for cutting soft tissue and plant matter
- Adjust the size required by simply cutting with scissors!
- Supplied in packs of 100



Cat No	Dimension	Price
CLS120259	19 mm H x 38 mm W x 0.22 mm thick	6,516.00
CLS120260	25 mm H x 50 mm W x 0.22 mm thick	7,337.00

Eco-smartFunnel™ Paper Funnel

- Cleanly slice agarose gels* right on the light box without scratching the surface
- Ideal for cutting soft tissue and plant matter
- Adjust the size required by simply cutting with scissors!
- Supplied in packs of 100



Cat No	Dimension	Price
CLS120219	Eco-smartFunnel™ 186 mL cap, Top Dia. 6 cm2, Bottom Dia. 0.64 cm2, Height 12.8 cm	10,192.00

Lead Rings

- Maintain flexibility and comfort in most applications
- Two sizes available; wrist length and forearm length
- Machine washable



Cat No	Type	lask sizes	id, mm	od, mm	weight, g	Price
CLS8882A	O-Shape	125 to 500 mL	48	77	277	6,252.00
CLS8882B	O-Shape	250 to 1000 mL	51	90	508	6,928.00
CLS8882C	O-Shape	500 to 2000 mL	57	98	635	8,279.00
CLS8882D	O-Shape	1000 to 4000 mL	70	115	970	9,124.00
CLS8881A	C-Shape	125 to 500 mL	42	75	227	7,265.00
CLS8881B	C-Shape	250 to 1000 mL	51	90	472	8,279.00
CLS8881C	C-Shape	500 to 2000 mL	54	98	599	9,124.00
CLS8881D	C-Shape	1000 to 4000 mL	66	113	907	9,800.00

Clearly Safe® Safety Glasses Dispensers

Ergonomically angled for easy dispensing Translucent acrylic dispensers provide easy access to safety accessories.

- Hinged lid protects glasses from dust and debris
- Set on counter or wall mount (screws included)
- Large Dispenser holds approx. 20 glasses, Small Dispenser approx. 10
- Great for holding other personal items, too!



Cat No	Description	l x w x d, mm	Color	Price
CLS1041	Small Safety Glass Dispenser	227 x 162 x 156	Blue	19,695.00
CLS1040A	Large Safety Glass Dispenser	203 x 203 x 406	Blue	35,655.00

Biohazard Disposal Bags

- Epoxy coated steel wire holder available for bags HS1003D & HS10320
- Autoclavable to 250°F (121°C)



Cat No	Description	Thickness	Dimension	Price
CLS10320	Bag, Case of 500	1.57	203 x 305	22776.00
CLS10321	Bag, Case of 200	1.57	356 x 483	20576.00
CLS10322	Bag, Case of 200	1.57	483 x 584	31788.00
CLS10323	Bag, Case of 200	1.57	635 x 838	76066.00
CLS10044H	Bag Holder			5372.00

Autoclavable Bags

Clear bags imprinted with blue biohazard labeling designed for safe disposal.

- 4 inner packs of 50 bags, sold as a case of 200



Cat No	w x l, mm	Price
CLS1002A	310 x 660	22,071.00
CLS1002B	415 x 600	24,523.00
CLS1002C	610 x 810	45,980.00

Heat Sealer with Cutter

Quickly and efficiently seal polyethylene or polypropylene bags, sheets or lat tubing from 0.01 to 0.8 mm thick. Sliding blade removes excess material 19 mm from the seal.

- Timing knob ensures safe sealing. Simply turn knob to set time (1-8 seconds), press handle down and remove when light indicates cycle is complete
- Heating element measures 310 mm long and is only hot when sealing

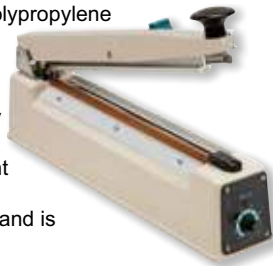

Cat No	Description	Plug Type	Price
CLS28271	220/230 VAC	Cont. Europe/Israel	53,560.00

e Count Colony Counter

eCount™ combines a multi-function electronic counter with a Sharpie® pen for marking to prevent missing or double-counting colonies.

- Light, ergonomic body is balanced for easy manipulation
- Select between an audible beep or an LED lash to acknowledge count
- Store up to 32 separate counts and display the total of all counts
- Count up/down verification
- Quick and easy to change between different
- Lock counter of to allow use of the marker without registering more counts



Cat No	Description	Price
CLS120000	Electronic Colony Counter Package	82,929.00

Sharpie® Marker Pens

- Dual-Tip Colored Sharpie® Pens
- Bright selection of colors offers instant visual recognition
- Combines a fine tip at one end and an ultrafine tip at the other end, perfect for a larger range of labeling requirements



Standard Black Sharpie® Pens

- Strong fine tip will keep its shape much longer than other brands of pens
- Long lasting, supplied in packs of 12

Cat No	Description	Pack	Price
CLS15094	Sharpie® Dual-Tip Pen Set (Assorted)	8/pk	7,970.00
CLS15092ZP	Sharpie® Standard Fine Pens (Black)	12/pk	8785.00

Mini -Light Box & Mini-Magnifier

Mini Light Box saves bench space and can be stored in a drawer.

- Viewing area (10 x 127 mm) is perfect for quick screening of 96-well plates, Petri dishes, electrophoresis gels, slides, and transparencies
- Powered by four AA batteries (included), Measures 161 x 135 x 44 mm
- Mini Magnifier enlarges objects for easier viewing
- Swiveling, molded lens. 1.75X magnification
- Lens measures 185 x 100 mm; stand measures 207 mm H



Cat No	Description	Price
CLS15093	Mini Light Box, With Batteries	35,708.00
CLS15092D	Mini Magnifier	25,189.00

smartPicks® Inoculation Picks

Available in three lengths and two needle sizes to suit a wide range of application needs. The Mini fits neatly into a 1.5 mL microfuge tube allowing the lid to be closed for full sample transfer/recovery.

- Naturally biodegradable, made from 100% USA grown White Birch wood
- Manufactured in an FDA-registered factory and comply with FDA standards for food contact
- Autoclavable and available in semi or needle point styles for delicate operations

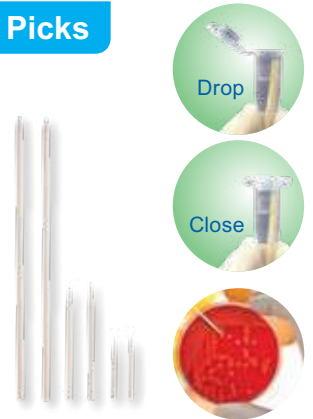

Cat No	Description	Qty	Price
CLS120009	Mini, Semi Point, 1.28", Fits 1.5 mL tube (closed)	2000/pk	21,577.00
CLS120010	Mini, Needle Point, Fits 1.5 mL tube (closed)	2000/pk	21,577.00
CLS120011	Standard, Semi Point, 2.5" Single Tip	1500/pk	23,638.00
CLS120012	Standard, Needle Point, 2.5" Single Tip	1500/pk	23,638.00
CLS120013	Large, Semi Point, 6" Single Tip	500/pk	15,333.00
CLS120014	Large, Needle Point, 6" Single Tip	500/pk	15,333.00

Inoculating Needle/Loops

Transfer bacterial cultures without risk of contamination.

- Use loop end to uniformly streak a gel surface
- Use needle end for removal of colonies
- Choose between flexible polypropylene or the more rigid ABS versions
- Disposable, Sterile, 20 per zip bag with lot-to-lot traceability
- Measures 200 mm L x 4 mm dia. Pack of 1000



Cat No	Description	Material	Price
CLS81121A	1 µL Loop	Flexible PP	15,333.00
CLS81121B	1 µL Loop	Rigid ABS	15,333.00
CLS81121C	10 µL Loop	Flexible PP	15,333.00
CLS81121D	10 µL Loop	Rigid ABS	15,333.00

Cell Spreaders

Delta™



L-Shape



Stainless Steel



Delta™: Flexible rippled handle and domed spreading bar to help reduce agar tears. Gamma sterilized

L-Shape: Lot-to-lot traceability, 10 wrap comes in a zip bag

Stainless Steel: Reusable. Flame and Autoclave sterilizable

Cat No	Description	Sterile	bar x dia, mm	Qty	Price
CLS8151	Delta™	Yes, single wrap	172 x 37 x 4	500/pk	20,242.00
CLS8171A	L-Shape	Yes, single wrap	146 x 38 x 4	500/pk	26,364.00
CLS8171B	L-Shape	Yes, 10 Wrap	146 x 38 x 4	500/pk	20,232.00
CLS86655	Stainless Steel	No	203 x 33 x 4	each	2,826.00

Petri Dish Dispenser

- Sturdy acrylic holds up to 30 x 100 mm dishes in two easy-access partitions
- Bench top or wall mountable (screws provided)
- Measures 222 x 107 x 236 mm



Cat No	Description	Price
CLS23452	Acrylic Petri Dish Dispenser	17,914.00

Wire Petri Dish Holder

- Holds up to 6 x 100 mm Petri Dishes
- Epoxy-coated steel wire
- Measures 127 x 86 x 107 mm



Cat No	Description	Price
CLS23455	Wire Petri Dish Holder	4,562.00

Droplet® Sample Storage Tray

- Large, usable, easy to clean surface area enables products of all shapes and sizes to be contained
- Stackable with other trays support as many as four high
- Integrated label holder and cards to enable easily changed identification
- Lightweight and sturdy insert to hold up to 24 full specimen containers (up to 58 mm in diameter). Specimen containers not included



Cat No	Description	Price
CLS120172	Droplet® Sample Storage Tray	15,533.00

Drawer Organizer

Polystyrene organizer is perfect for storing and organizing small laboratory supplies.

- Protect small and fragile items
- Fit in most standard drawers or store on benches and shelves
- Dimensions: 460 x 307 x 63 mm



Cat No	Description	Price
CLS2538A	3-Compartment Tray: 2 compartments measure 430 x 80 mm 1 compartment measures 430 x 110 mm	10,306.00

MagLab™ Series



Create lab storage space-of your bench top

Easily organize common of your bench top with color and features four most metal surfaces, or create your own holding point with the metal plate provided.

the MagLab™ storage system. Each rack is made of robust ABS plastic in a bright translucent color and features four powerful magnets for a secure hold onto most metal surfaces, or create your own holding point with the metal plate provided.

- MagRack™ holds four 50 mL tubes and nine 15 mL tubes
- MagWipe™ holds a standard (110 x 210 mm) Kimwipes® box
- MagPette™ holds two pipettors (its most popular styles)
- MagBox™ holds miscellaneous accessories
- Use the MagLab™ self-adhesive mounting plates for use on non-metallic surfaces
- The MagLab™ Series is available individually or as a pack of four

Cat No	Description	Color	l x w x h, mm	Price
CLS23500	MagLab Series, 4/pk	Teal/Green/Purple/Orange	522 x 393 x 102	15,476.00
CLS23501	MagRack	Teal	131 x 112 x 64	4,464.00
CLS23502	MagWipe	Green	130 x 91 x 98	4,464.00
CLS23503	MagPette	Purple	131 x 112 x 76	4,464.00
CLS23504	MagBox	Orange	130 x 78 x 102	4,464.00

Clearly Safe® Workstation Storage Bin

The essential combination accessory holder
Organize your most commonly used laboratory disposables in one central location.

- Acrylic unit has room to store gloves, Kimwipes®, and Parafilm®
- Use bins to store tubes, tips, etc.
- Measures 265 x 137 x 440 mm



Cat No	Description	Price
CLS234523	Workstation Storage Bin	35,486.00

Benchtop Dispensing Bins

Work great with gloved hands, bright colors!

Ergonomically designed with large, angled openings and oversized lip.

- Lid remains open when tilted back
- Nonskid rubber feet and pre-drilled holes for wall mounting
- Green bin includes a removable divider
- Mounting screws included



Cat No	Color	Compartments	w x h x d, mm	Price
CLS23411	Neon Green	Dual	180 x 155 x 165	17,231.00
CLS23412	Neon Blue	Single	155 x 155 x 170	17,742.00

Pipette Workstation

Keep pipette and disposable tips together in one convenient stand.

- Acrylic rack holds up to four pipettors on top shelf
- Dual bins house two different sizes of tips. Self-closing lids provide dust-free storage
- Oversized lip on lid allows for easy access even when wearing gloves
- Measures 244 x 165 x 246 mm



Cat No	Description	Price
CLS234631	Pipette Workstation	30,414.00

Workstation Dispensing Bins

See inventory levels of pipette tips, tubes, fittings, finger cots, and other bulk small items at a glance.

- Flip-top covers on generous openings make filling and dispensing easy and keep products dust-free
- 4 sizes available to cater to a wide variety of storage needs
- Includes non-skid rubber feet



Cat No	No Bins	l x w x d, mm	Price
CLS23401	One	180 x 175 x 235	16,380.00
CLS23402	Two	139 x 160 x 368	19,108.00
CLS23403	Three	210 x 155 x 212	21,837.00
CLS23404	Four	278 x 158 x 217	23,202.00

Modular Glove Box Holders

The Anti-Microbial version (blue) is ideal for use in clean rooms, hospitals, and microbiological work areas. The Microban additive prevents growth of molds and bacteria.

- High-impact, durable resin is resistant to harsh cleaning solutions
- Modular design allows single boxes or horizontal stacking for multiple box holder
- Universal fit for most major brands of glove boxes
- Mounting screws included
- Each unit measures 254 x 156 x 97 mm. Pack of 3



Cat No	Description	Color	Price
CLS120258	Modular Glove Box Holder	White	18,210.00
CLS23491A	Modular Glove Box Holder, Anti-Microbial	Blue	23,818.00

Glove Box Holders

Free up benchtop space by mounting holders on wall for easy dispensing of gloves.

- Clear acrylic holders include a polyester foam insert to securely hold a range of glove box sizes—snug fit ensures easy removal of gloves
- Sturdy, epoxy-coated steel wire racks are an economical solution
- All holders fit most major brands of boxes
- Mounting screws included



Cat No	Description	Material	w x h x d, mm	Price
CLS23471A	1-Box Holder	Acrylic	141 x 260 x 110	11,089.00
CLS23471B	2-Box Holder	Acrylic	295 x 260 x 110	16,890.00
CLS23471C	3-Box Holder	Acrylic	295 x 385 x 110	19,961.00
CLS23457	1-Box Holder	Wire	140 x 209 x 108	5,576.00
CLS23458	3-Box Holder	Wire	250 x 454 x 108	11,152.00

Wall Holder 4 Position Adjustable

Not just for glove boxes! Ideal for gloves, face masks, shoe covers... etc. The adjustable holding points provide true flexibility to hold up to four different boxed protective products and other lab essentials (size dependent)

- Ideal for holding different boxed sizes of gloves, mop caps, ear plugs, face masks, shoe covers etc.
- Adjustable universal fit, easy to clean, with a low profile
- Wall- or door-mountable, mounting hardware included
- Measures 152 x 762 x 76 mm



Cat No	Description	Color	Price
CLS120107	Adjustable Wall Holder		37,497.00

Lab Wipe Holders

Clear acrylic holders in boxes of small or large lab wipes.

- Mount on a shelf or wall
- The smaller version attaches with double-stick tape and the larger version with screws
- Mounting materials included



Cat No	Description	l x w x d, mm	Price
CLS234521	Small Holder	118 x 122 x 84	4,095.00
CLS234522	Large Holder	320 x 127 x 97	8,530.00

Storage Racks for 80-Well Racks

These racks help you keep large numbers of microtubes organized on your benchtop.

- Holds up to eight 80-well microtube racks filled with either 1.5 or 2.0 mL microtubes
- Plenty of room to slide the racks in and out

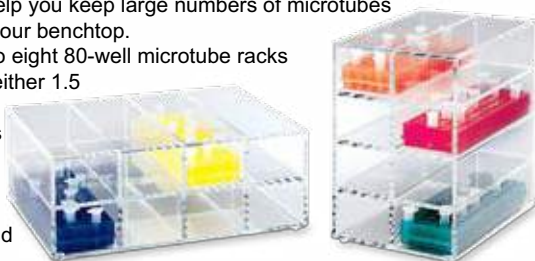

Cat No	Description	l x w x d, mm	Price
CLS23263A	Vertical Rack	157 x 236 x 234	44,144.00
CLS23263B	Horizontal Rack	310 x 236 x 122	44,144.00

Floating Microtube Racks

- Detachable legs provide two options: Attach legs so rack stands upright on bench top, or detach legs so samples can be quickly popped out by pushing down onto any surface.
- Not recommended for cleaning in autoclave.
- Measure 60 mm high including legs.
- Pack of 4.



Cat No	Shape	Tubes	Well	Color	Price
CLS2132A	Square (102 mm)	1.5/2.0 mL	16	White	6,694.00
CLS2134A	Round (98 mm dia)	1.5/2.0 mL	20	White	6,694.00

Soft Cover Dispenser

Translucent acrylic dispensers provide easy access to safety accessories.

- Hinged lid protects contents from dust and debris
- Set on counter or wall mount (screws included)
- Great for holding other personal items, too!



Cat No	Description	w x h x d, mm	Color	Price
CLS1042C	Soft Cover Dispenser	227 x 162 x 156	Natural	48,898.00

Earplug Dispenser

Translucent acrylic dispensers provide easy access to safety accessories.

- Holds approximately 200 pairs of foam earplugs
- Set on counter or wall mount (screws included)



Cat No	Description	w x h x d, mm	Color	Price
CLS1040B	Earplug dispenser	227 x 162 x 156	Green	35,655.00

Three-in-One Dispenser

Three separate lift-up lids make loading and dispensing supplies easy.

- Middle compartment has reach-in hole for dispensing
- Durable acrylic is see-through so product levels are always visible



Cat No	Description	w x h x d, mm	Color	Price
CLS1042	Three-in-One dispenser	406 x 406 x 203	Grey	48,898.00

Tubby® Container

Sturdy storage tub with lid and divider

- The lid snaps in place to secure the contents and for safe transport



Cat No	Description	Qty	w x h x d, mm	Price
CLS23453	Tubby	Pk/5	330 x 200 x 115	8,955.00

Wire Drying Rack

Saves glassware from chips and cracks
Drain and dry test tubes, beakers, flasks, and other labware.

- Holds up to 90 pieces of labware on 18 x 127 mm pins and 72 x 76 mm pins
- Constructed of spot-welded, vinyl-coated steel wire for durability
- Easily accessible and removable bottom drainage pan



Cat No	Description	Price
CLS23243A	Wire Drying Rack	28,886.00

Foil Rolls

Designed for easy use and minimal waste

- Ideal for autoclaving, freezing, incubating, protecting labware, lining, sealing, and general storage



Cat No	Description	Roll Size	Price
CLS23534A	102 mm (4-inch) length Foil Roll	152.4 m	3,372.00
CLS23536A	153 mm (6-inch) length Foil Roll	152.4 m	4,904.00

Test Tube Baskets



Ideal for washing and storing test tubes
Strong baskets for use with mechanical washers and autoclaves.

- Two versions available, epoxy-coated steel, or the lighter weight aluminum style
- Will withstand repeated autoclaving and use in the lab

	Cat No	Material	l x w x h, mm	Price
A	CLS20341A	Aluminum	152 x 152 x 152	6,590.00
B	CLS20341B	Aluminum	256 x 152 x 152	7,401.00
C	CLS20341C	Aluminum	332 x 228 x 178	9,631.00
D	CLS120082	Coated steel	125 x 125 x 125	4,893.00
E	CIS120083	Coated steel	150 x 150 x 150	5,977.00
F	CLS120084	Coated steel	332 x 228 x 178	9,237.00

Label Station

Organize your labels for easy accessibility

- Acrylic station includes a writing surface, a cutting edge for easy dispensing, and non-skid rubber feet
- Counter-sunk holes provided for wall mounting



Cat No	Description	Color	l x w x h, mm	Price
CLS23460	Label Station	Blue	280 x 120 x 89	21,307.00

ABS Dispenser for Parafilm® Sealing Film

Unique design for maximum safety
Store, dispense, and cut Parafilm®, tape, labels, and Tough-Tags®.

- ABS plastic dispenser designed with a safety razor that slides and cuts with no danger to fingers. Supplied with two easily exchanged cutting blades



Cat No	Description	Color	w x h x d, mm	Price
CLS234525B	ABS Dispenser	Blue	120 x 156 x 171	12,165.00
CLS234525C	ABS Dispenser	Green	120 x 156 x 171	12,165.00
CLS234525D	ABS Dispenser	Red	120 x 156 x 171	12,165.00
CLS234525R	Replacement blades for ABS dispenser, pack of 5			1,585.00

Parafilm® Sealing Film

Parafilm® M is a semi-transparent, flexible, thermoplastic film with two-way stretch.

- Will stretch 200% and adhere to irregular shapes and surfaces to provide a secure seal



Cat No	Film Width	Roll Length	w x h x d, mm	Price
CLS234526A	50 mm (2-inch)	75 m	135 x 58 x 132	9,188.00
CLS234526B	100 mm (4-inch)	38 m	132 x 135 x 112	9,498.00
CLS234526C	100 mm (4-inch)	75 m	135 x 107 x 132	16,506.00

DuraSEAL™

Durable heat-resistant, solvent-proof Laboratory stretch ilm

- Heat-resistant and microwave compatible for temperatures up to 100°C (boiling water)
- Highly resistant to solvents and caustic agents
- Film can stretch 500–800% before breaking or tearing
- Forms an airtight barrier and is twice as long as some other brands!



Stretches 500-800%



Cat No	Size	Ideal Use	Price
CLS-1-150	25 mm x 46 m/1.0" x 150'	Tubes/Vials	8,944.00
CLS-2-500	50 mm x 152 m/2.0" x 500'	Beakers	14,144.00
CLS-4-250	100 mm x 76 m/4.0" x 250'	Jars/Bottles	19,968.00
CLS-4-500	100 mm x 152 m/4.0" x 500'	Jars/Bottles	26,000.00
CLS-5-150	127 mm x 46 m/5.0" x 46'	Large Containers	17,264.00

PetriSEAL™ and ContainerSEAL™

Sealing tape for Petri Dishes, Microplates, lids and caps

- Seal remains flexible even with intermittent exposure to 100°C
- Tape stretches, conforms and seals to irregular perimeters
- Waterproof and chemically resistant to most solvent and caustic agents



Cat No	Size	Description	Price
CLS-SEAL-108B	13 mm x 33 m/0.5" x 108'	PetriSEAL Blue	15,600.00
CLS-SEAL-108C	13 mm x 33 m/0.5" x 108'	PetriSEAL Clear	15,600.00
CLS-SEAL-108R	13 mm x 33 m/0.5" x 108'	PetriSEAL Red	15,600.00
CLS-SEAL-108Y	13 mm x 33 m/0.5" x 108'	PetriSEAL Yellow	15,600.00
CLS-SEAL-108W	13 mm x 33 m/0.5" x 108'	PetriSEAL White	15,600.00
CLS-SEAL-75R	8.5 mm x 33 m/0.75" x 108'	ContainerSEAL Red	20,800.00
CLS-SEAL-75W	8.5 mm x 33 m/0.75" x 108'	ContainerSEAL White	20,800.00
CLS-SEAL-75Y	8.5 mm x 33 m/0.75" x 108'	ContainerSEAL Yellow	20,800.00
CLS-SEAL-XLR	25 mm x 33 m/1.0" x 108'	ContainerSEAL Red XL	20,800.00
CLS-SEAL-XLW	25 mm x 33 m/1.0" x 108'	ContainerSEAL White XL	20,800.00
CLS-SEAL-XLY	25 mm x 33 m/1.0" x 108'	ContainerSEAL Yellow XL	20,800.00

Mini Bin™ Foil Dispenser

Safely cut foil to any size

- Compact to fit in limited work space areas and easy to transport
- Safe to use—load the foil roll, press the cover to activate the safety guard
- Foam strip prevents foil retracting back into unit
- For use with 102 mm or 153 mm (4 or 6 inch) length foil rolls (sold separately)



Cat No	w x h x d, mm	Price
CLS23520A	190 x 100 x 112	17,857.00

Laboratory Notebooks

For recording research data, experimental procedures, and design ideas, use these notebooks to keep information safe and well organized.

- Numbered, acid-free, pages include spaces for title, project number, book number, date, and witness signature
- Lined notebooks feature college-ruled pages for easy report writing
- Covers for all versions are waterproof and chemical-resistant
- All notebooks contain periodic and conversion tables in the back
- Measures 218 x 281 mm



Cat No	Description	Page Format	Color	Qty	Price
CLS8610A	100-Page Notebook	Grid	Black	12/cs	74,090.00
CLS8610B	200-Page Notebook	Grid	Blue	12/cs	92,591.00
CLS8610D	200-Page Notebook	Lined	Red	12/cs	90,136.00

Time Tracker® Mini

Based on the Original Time Tracker, the Mini is an economical option intended for easy use.

- Total alarm time ranges from 5 to 120 minutes in 5-minute increments
- Visual indicator features lighted dome. Green light during count down; yellow for the designated "warning" time; red when time has expired
- Volume control and audible warning alarm
- Requires 3 AAA batteries, not included. Measures 83 x 83 x 121 mm



Cat No	Description	Price
CLS24653	Time Tracker Mini	12,870.00

Time Tracker®

Makes it easy to monitor your process from a distance! Designed like a traffic signal so the meaning of each light is intuitive. Green light means less than half done; yellow means more than half done, and red means finished.

- Programmable time
- Six different audible alerts. With LCD display
- LCD with 8 mm high characters, 10 characters across. Operates on 110 VAC adapter (included)
- Measures 112 x 118 x 230 mm



Cat No	Description	Price
CLS24651	Time Tracker	21,311.00

Heat Resistant Gloves

Terry cloth gloves provide durability and long wear with heat and abrasion resistance

- Applications include: general use for handling utensils, handling items when autoclaving, light/medium fabrication, metal and glass handling, etc.
- Gloves are heat resistant when dry (do not use when wet, near steam, with sharp objects, or with LN2)
- Made of 100% knitted cotton terry cloth that is washable
- Glove is designed with a straight thumb allowing more comfort and flexibility with heat barrier
- Gauntlets provide extra safety for wrist and forearm protection



Specifications

- Overall Length: Approximately 480 mm (18.9 in)
- Width (Palm): Approximately 135 mm (5.3 in)

Cat No	Description	Size	Color	Qty	Price
CLS120483	Heat Resistant Gloves	Universal	Brown	2 gloves per pack	9,630.00

smartBOATS

Made from FSC® Certified (FSC® Mix) paper (Eco-IN) and when disposed of in the standard waste stream they will naturally biodegrade (Eco-OUT)

A truly green solution to sample weighing.

- Made of grease proof paper that meets FDA 21 CFR 176.170 (components of paper in contact with aqueous and fatty foods) and with 21 CFR 176.180 (contact with dry foods)
- Control contents like a polystyrene weigh boat
- An alternative to regular weighing papers
- Available in a small and medium in both brown for light colored samples and white for dark samples



Cat. No.	Size	L x W x H	Color	Pack Size	Price
CLS120312	Small	35 x 35 x 15.8 mm	Brown	500/pk	10,977.00
CLS120313	Medium	47.6 x 47.6 x 14.2 mm	Brown	500/pk	12,693.00
CLS120314	Small	35 x 35 x 15.8 mm	White	500/pk	10,977.00
CLS120315	Medium	47.6 x 47.6 x 14.2 mm	White	500/pk	12,693.00



- A. Pocket Timer/Stopwatch/Clock**
 - Four independent timing channels with visual and audible alarms
 - Use as a stopwatch, a count up/down timer, or a clock
 - Includes spring clip and magnetic back
- B. Triple Timer/Clock**
 - Three channels to count up/down with
 - Simultaneous display, time-out, and 60 second audible alarm
 - Channels may be started independently or simultaneously
 - Timer automatically counts up after counting down to zero
 - Memory recall
- C. Digital Sand Timer/Clock**
 - Watch the digital sand gradually disappear over time just like mechanical sand timers
 - Audible and visual alarms
 - Flip one way to display count up/down timer, flip the other way to display the clock in 12- or 24-hour mode
 - Memory recall
- D. Big-Digit Dual Timer/Clock**
 - Display clock and timer simultaneously, or two independent timers
 - Use one timer to count up, or use two timers to count down independently
 - Audible and visual alarm
- E. Multi-Function Stopwatch/Clock**
 - Quick start, quick stop timer features time, split, hourly chime, calendar, alarm
 - 100 cm neck cord
- F. Four Channel Timer/Clock**
 - Independently or simultaneously set time on four channels
 - Audible and visual alarms signify elapsed time
 - Easily toggle between channels and clock with top buttons
 - Includes spring clip with magnetic back

Cat No	No of Channels	Timing Capacity	Resolution	Count Direction	Display Digits, h	Clock	Alarm	Battery	l x h x d, mm	Price	
A	CLS24490D	Four	100 Hr.	1/100 Sec.	Up/down	6 mm	Yes	Yes	One LR44 1.5V	61 x 71 x 25	5,742.00
B	CLS24490M	Three	20 Hr.	1/100 Sec.	Down	10.5 mm	Yes	Yes	One AAA	86 x 66 x 22	7,570.00
C	CLS24671	One	99 Min.	1 Sec.	Up/down	15 mm	Yes	Yes	Three LR44	58 x 114 x 35	5,820.00
D	CLS24780	Two	24 Hr.	1/100 Sec.	Up/down	25.5 mm	Yes	Yes	One AAA	142 x 97 x 20	9,630.00
E	CLS24645	One	60 Min.	1/100 Sec.	Up	8.5 mm	Yes	Yes	One LR44 1.5V	87 x 78 x 21	7,941.00
F	CLS24670	Four	99 Hr.	1/100 Sec.	Down	14 mm	Yes	Yes	Two LR44	73 x 59 x 13	5,819.00



Code	Product Description	Label	Pk Size	Price	Code	Product Description	Label	Pk Size	Price
CLS-122 BLACK	Solvent Resistant Pen, black	Laboratory Marker	5	3790.00	CLS-CLTT-3000	Clear Laser Tough-Tags 1.05 x 0.50" 1,920/pk	Labels	5	50050.00
CLS-130 RED	Solvent Resistant Pen, red	Laboratory Marker	5	3790.00	CLS-CMBO-1000	Laser Cryo-Babies/Tough-Spot Set	Labels	5	46200.00
CLS-GD-110760	Gel Drying Frames 14 x 14cm	Gel Related	5	81713.50	CLS-COLB-1000	Color Coded Tough-Tags, Blue 500/roll	Labels	5	41085.00
CLS-GD-110761	Gel Drying Frames 24 x 24cm	Gel Related	5	160688.00	CLS-COLG-1000	Color Coded Tough-Tags, Green 500/roll	Labels	5	41085.00
CLS-C-110762	Cellophane 14 x 14cm-50/pk	Gel Related	5	10955.00	CLS-COLR-1000	Color Coded Tough-Tags, Red 500/roll	Labels	5	41085.00
CLS-C-110763	Cellophane 24 x 24cm-50/pk	Gel Related	5	15520.00	CLS-COLW-1000	Color Coded Tough-Tags, White 500/roll	Labels	5	41085.00
CLS-TP-1000	Autoclave Indicator Tape 0.75" x 2160"	Tape	5	11165.00	CLS-COLY-1000	Color Coded Tough-Tags, Yellow 500/roll	Labels	5	41085.00
CLS-TP-2000	Autoclave Indicator Tape 1.00" x 2160"	Tape	5	13475.00	CLS-CRTH-1081	TT Cryo-Babies 0.81 x 0.28" 2,000/roll	Labels	5	62254.50
CLS-TT-1000	Chameleon Tough-Tags® 0.94" x 0.50" 1,000/Roll	Labels	5	34650.00	CLS-CRTH-1094	TT Cryo-Babies 0.94" x 0.50" 2,000/roll	Labels	5	62254.50
CLS-TT-2000	Chameleon Tough-Tags® 1.28" x 0.50" 1,000/Roll	Labels	5	42350.00	CLS-CRTH-1128	TT Cryo-Babies 1.28 x 0.50 2,000/roll	Labels	5	77000.00
CLS-AGM-200	Agarmate, 200g	Gel Related	5	81255.00	CLS-CRTH-1200	TT Cryo-Babies 1.05 x 0.50" 2,000/roll	Labels	5	56980.00
CLS-ALUM-1000	Alumina Seal, 100/pk	Sealing Film	5	62085.00	CLS-CRTH-2100	TT Cryo-Babies 1.375 x 0.625" 2,000/roll	Labels	5	65450.00
CLS-ARS-150	Autoradiography Ruler Set	Gel Related	5	26400.00	CLS-CRTH-2300	TT Cryo-Babies 1.05 x 0.50" 4,000/roll	Labels	5	1659200.00
CLS-BT-250	Bake Tags 1.50 x 0.75" 250/roll	Labels	5	60280.00	CLS-CRTH-3000	TT Cryo-Babies 1.50 x 0.50" 2,000/roll	Labels	5	84045.00
CLS-BE-1	Breathe-Easy, 100/pk	Sealing Film	5	72945.00	CLS-CRTH-3081	TT Cryo-Babies 0.81" x 0.28" 4,000/roll	Labels	5	174720.00
CLS-BE-1000	Breathe-Easy Strips	PetriDish Accessories	5	54780.00	CLS-CRTH-3094	TT Cryo-Babies 0.94" x 0.50" 4,000/roll	Labels	5	174720.00
CLS-BE-2000	Breathe-EASIER, 100/pk	Sealing Film	5	54780.00	CLS-CRTH-3100	TT Cryo-Babies 1.28" x 0.50" 4,000/roll	Labels	5	165760.00
CLS-TS-1001	7/16" Bullseye Tough-Spots, Dark Blue	Labels	5	28413.00	CLS-CRTH-3128	TT Cryo-Babies 1.28" x 0.50" 4,000/roll	Labels	5	212800.00
CLS-TS-1002	7/16" Bullseye Tough-Spots, Dark Green	Labels	5	28413.00	CLS-CRTH-3150	TT Cryo-Babies 1.28" x 0.50" 4,000/roll	Labels	5	308000.00
CLS-TS-1003	7/16" Bullseye Tough-Spots, Copper	Labels	5	28413.00	CLS-CRTH-3155	TT Cryo-Babies 1.28" x 0.50" 4,000/roll	Labels	5	233137.00
CLS-TS-1004	7/16" Bullseye Tough-Spots, Plum	Labels	5	28413.00	CLS-CRTH-3225	TT Cryo-Tags 2.00 x 0.25" 4,000/roll	Labels	5	179200.00
CLS-TS-1000	3/8" BioHazard Tough-Spots 1,000/roll	Labels	5	19250.00	CLS-CRTH-4000	TT Cryo-Tags 1.50 x 0.75" 2,000/roll	Labels	5	103565.00
CLS-BM-1000	Breathe-EASY Membranes, 100/pk		5	32865.00	CLS-CRTH-5000	TT Cryo-Tags 2.00 x 0.25" 2,000/roll	Labels	5	59675.00
CLS-BM-2000	Breathe-EASIER Membranes, 100/pk		5	32865.00	CLS-CRY-0500	Cryo-Babies 0.94 x 0.50" 1,000/roll WHITE	Labels	5	23100.00
CLS-BOAT-1000	Weigh-Better Boats 150/PK	Weighing Boats	5	24194.50	CLS-CRY-1000	Cryo-Babies 1.28 x 0.50" 1,000/roll WHITE	Labels	5	23100.00
CLS-BOAT-2000	Weigh-Better Boats 24/case	Weighing Boats	5	710480.00	CLS-CRY-1000-B	Cryo-Babies 1.28 x 0.50" 1,000/roll BLUE	Labels	5	26895.00
CLS-BOC-1000	Benchtop Bottle Cooler, 0.5 liter	Benchtop Coolers	5	8580.00	CLS-CRY-1000-G	Cryo-Babies 1.28 x 0.50" 1,000/roll GREEN	Labels	5	26895.00
CLS-BOC-2000	Benchtop Bottle Cooler, 1.0 liter	Benchtop Coolers	5	21175.00	CLS-CRY-1000-O	Cryo-Babies 1.28 x 0.50" 1,000/roll ORANGE	Labels	5	26895.00
CLS-WP-1000	Bio-Pure Alcohol Wipes		5	10043.00	CLS-CRY-1000-R	Cryo-Babies 1.28 x 0.50" 1,000/roll RED	Labels	5	26895.00
CLS-WP-2000	Bio-Pure Surfactant Alcohol Wipes		5	10043.00	CLS-CRY-1000-Y	Cryo-Babies 1.28 x 0.50" 1,000/roll YELLOW	Labels	5	26895.00
CLS-SRB-4000	4" Soft Rubber Brayer	Sealing Film	5	17908.00	CLS-CRY-2000	Cryo-Tags 1.50 x 0.75" 1,000/roll WHITE	Labels	5	23100.00
CLS-CB-1501	1°C Cool Brick	Cooler Accessories	5	26400.00	CLS-CRY-2000-B	Cryo-Tags 1.50 x 0.75" 1,000/roll BLUE	Labels	5	28240.00
CLS-CB-1520	-10°C Cool Brick	Cooler Accessories	5	30800.00	CLS-CRY-2000-G	Cryo-Tags 1.50 x 0.75" 1,000/roll GREEN	Labels	5	28240.00
CLS-CB-2501	1°C Cool Brick	Cooler Accessories	5	26400.00	CLS-CRY-2000-O	Cryo-Tags 1.50 x 0.75" 1,000/roll ORANGE	Labels	5	28240.00
CLS-BAG-1000	Cool Safe Bag for easy transport	Cooler Accessories	5	17600.00	CLS-CRY-2000-R	Cryo-Tags 1.50 x 0.75" 1,000/roll RED	Labels	5	28240.00
CLS-NC-A960	Novel Carriers for 2ml Tubes, Set of 2	Cooling Chambers	1	332800.00	CLS-CRY-2000-Y	Cryo-Tags 1.50 x 0.75" 1,000/roll YELLO	Labels	5	28240.00
CLS-CHAM-A100	96-Well Cooling Chamber for Automation	Cooling Chambers	1	57600.00	CLS-CSAF-1000	CoolSafe System for 0.2ml tubes	Benchtop Coolers	1	79360.00
CLS-CHAM-1000	Chamber for 0.2ml PCR plates or tubes	Cooling Chambers	1	53504.00	CLS-CSAF-2000	CoolSafe System for 0.5ml tubes	Benchtop Coolers	1	79360.00
CLS-CHAM-1020	Double Chamber for 0.2ml tubes	Cooling Chambers	1	94464.00	CLS-CSAF-3000	CoolSafe System for 1.5ml tubes	Benchtop Coolers	1	67072.00
CLS-CHAM-2000	Chamber for 0.5ml tubes	Cooling Chambers	1	49920.00	CLS-CSAF-3050	CoolSafe System for 1.5 Cryogenic tubes	Benchtop Coolers	1	67072.00
CLS-CHAM-3000	Chamber for 1.5ml tubes	Cooling Chambers	1	43520.00	CLS-CSAF-3100	CryoVial CoolSafe System for 1.2 Cryogenic tubes	Benchtop Coolers	1	102400.00
CLS-CHAM-3006	Mini Chamber 1.5-2.0ml Tubes, 6 Holes	Cooling Chambers	5	101200.00	CLS-CSAF-3200	CryoVial CoolSafe System for 2.0 Cryogenic tubes	Benchtop Coolers	1	102400.00
CLS-CHAM-3015	Mini Chamber 1.5-2.0ml Tubes, 15 Holes	Cooling Chambers	5	172800.00	CLS-CSAF-3840	CoolSafe System for 384-well plates	Benchtop Coolers	1	85760.00
CLS-CHAM-3030	Mini Chamber 1.5 -2.0ml Tubes, 30 Holes	Cooling Chambers	5	192000.00	CLS-CSAF-4000	CoolSafe System for 5ml tubes	Benchtop Coolers	1	69880.00
CLS-CHAM-3050	Chamber for 1.5ml Cryogenic tubes	Cooling Chambers	1	45824.00	CLS-CSAF-5000	CoolSafe System for multi-tube format	Benchtop Coolers	1	67072.00
CLS-CHAM-3100	CryoVial Cooling Chamber for 1.2ml Cryogenic tubes	Cooling Chambers	1	83200.00	CLS-CSAF-9600	CoolSafe System for 96-well Microplates	Benchtop Coolers	1	59260.00
CLS-CHAM-3200	CryoVial Cooling Chamber for 2.0ml Cryogenic tubes	Cooling Chambers	1	83200.00	CLS-CSEAL-75R	ContainerSEAL, red	Tape	5	35545.00
CLS-CHAM-3300	CryoVial Cooling Chamber for 3.0-4.0ml Cryogenic tubes	Cooling Chambers	1	96000.00	CLS-CSEAL-75W	ContainerSEAL, white	Tape	5	35545.00
CLS-CHAM-3840	Chamber for 384-well microplates	Cooling Chambers	1	74240.00	CLS-CSEAL-75Y	ContainerSEAL, yellow	Tape	5	35545.00
CLS-CHAM-4000	Chamber for 5ml tubes	Cooling Chambers	1	48640.00	CLS-CSEAL-XLR	ContainerSEAI XL Red 1" x 108'	Tape	5	34650.00
CLS-CHAM-5000	Chamber for multi-tube format	Cooling Chambers	1	48640.00	CLS-CSEAL-XLW	ContainerSEAI XL White 1" x 108'	Tape	5	34650.00
CLS-CHAM-6000	Chamber for 15ml tubes, 6 holes	Cooling Chambers	1	48640.00	CLS-CSEAL-XLY	ContainerSEAI XL Yellow 1" x 108'	Tape	5	34650.00
CLS-CHAM-6050	Chamber for 15ml tubes, 12 holes	Cooling Chambers	1	48640.00	CLS-CSF-BOX	CoolSafe Box	Cooler Accessories	5	25960.00
CLS-CHAM-6400	64-Place Step Chamber	Cooling Chambers	1	80640.00	CLS-DS1-150	Test Tube Seal 1" x 150'	Sealing Film	5	18920.00
CLS-CHAM-7000	Chamber for 50ml tubes, 2 holes	Cooling Chambers	1	40448.00	CLS-DS2-500	Duraseal, 2" x 500'	Sealing Film	5	29920.00
CLS-CHAM-7050	Chamber for 50ml tubes, 4 holes	Cooling Chambers	1	45937.80	CLS-DS4-250	Duraseal, 4" x 250'	Sealing Film	5	42240.00
CLS-CHAM-8000	80-well Chamber for 1.5ml tubes	Cooling Chambers	1	13200.00	CLS-DS4-500	Duraseal, 4" x 500'	Sealing Film	5	55000.00
CLS-CHAM-9600	Microplate Chamber	Cooling Chambers	1	12760.00	CLS-DS5-150	Duraseal, 5" x 150'	Sealing Film	5	36520.00
CLS-CHAM-LIFT	6 1/8"L x 3 1/8" W x 1/2" H Dry Bath Lifting Block	Cooling Chambers	1	13200.00	CLS-DSC1-150	Test Tube Seal 1" x 150'	Sealing Film	5	23760.00
CLS-CHDN-1000	Chill Down Agarose Cooling chamber	Gel Related	1	12760.00	CLS-DSC2-500	Duraseal, 2" x 500'	Sealing Film	5	42240.00
CLS-CLEAR-170	Cryo-Clear Laser Labels 1.28 x 0.50" 1,700/pk,	Labels	5	48510.00	CLS-DSC4-500	Duraseal, 4" x 500'	Sealing Film	5	73040.00
CLS-CLEAR-238	Cryo-Clear Laser Labels 0.94 x 0.50" 2,380/pk	Labels	5	48510.00	CLS-DSC5-150	Duraseal, 5" x 150'	Sealing Film	5	66000.00
CLS-CLTT-1000	Clear Laser Tough-Tags 1.50 x 0.75" 1,200/pk	Labels	5	50050.00	CLS-DSH-100	DuraSharp Shears	Sealing Film	5	9680.00
CLS-CLTT-2000	Clear Laser Tough-Tags 1.50 x 0.50" 1,600/pk	Labels	5	50050.00	CLS-DTCR-1000	DT Cryo-Tags 1.05 x 0.50" 1,000/roll WHITE	Labels	5	33110.00
					CLS-DTCR-1000-BDT	Cryo-Tags 1.05 x 0.50" 1,000/roll BLUE	Labels	5	33110.00
					CLS-DTCR-1000-GDT	Cryo-Tags 1.05 x 0.50" 1,000/roll GREEN	Labels	5	33110.00
					CLS-DTCR-1000-ODT	Cryo-Tags 1.05 x 0.50" 1,000/roll ORANGE	Labels	5	33110.00



Code	Product Description	Label	Pk Size	Price	Code	Product Description	Label	Pk Size	Price
CLSDTCR-2000	DT Cryo-Tags 1.50 x 0.50" 750/roll WHITE	Labels	5	30800.00	CLSLBTP-2200	Labeling Tape, Green 3/4" x 2,160"/ Roll	Tape	5	24640.00
CLSDTCR-200-B	DT Cryo-Tags 1.50 x 0.50" 750/roll BLUE	Labels	5	32340.00	CLSLBTP-2300	Labeling Tape, Blue 3/4" x 2,160" / Roll	Tape	5	24640.00
CLSDTCR-2000-G	DT Cryo-Tags 1.50 x 0.50" 750/roll GREEN	Labels	5	32340.00	CLSLBTP-2400	Labeling Tape, Red 3/4" x 2,160" / Roll	Tape	5	24640.00
CLSDTCR-2000-Y	DT Cryo-Tags 1.50 x 0.50" 750/roll YELLOW	Labels	5	32340.00	CLSLCRY-1000	Laser Cryo-Tag Sheet, 20/pk	Labels	5	38500.00
CLSDTCR-3000	DT Cryo-Tags 1.50 x 0.75" 750/roll WHITE	Labels	5	33110.00	CLSLCRY-1100	Laser Cryo-Tags 1.69 x 0.75" 1,040/pk	Labels	5	46200.00
CLSDTCR-3000-B	DT Cryo-Tags 1.50 x 0.75" 750/roll BLUE	Labels	5	34820.00	CLSLCRY-1100-B	Laser Cryo-Tags 1.69 x 0.75" Blue	Labels	5	46200.00
CLSDTCR-3000-G	DT Cryo-Tags 1.50 x 0.75" 750/roll GREEN	Labels	5	34820.00	CLSLCRY-1100-G	Laser Cryo-Tags 1.69 x 0.75" Green	Labels	5	46200.00
CLSDTCR-3000-Y	DT Cryo-Tags 1.50 x 0.75" 750/roll YELLOW	Labels	5	34820.00	CLSLCRY-1100-O	Laser Cryo-Tags 1.69 x 0.75" Orange	Labels	5	46200.00
CLSDTCR-4000	DT Cryo-Spots. 3/8" diam., 1,000/roll WHITE	Labels	5	50165.00	CLSLCRY-1100-R	Laser Cryo-Tags 1.69 x 0.75" Red	Labels	5	46200.00
CLSDTCR-4001	DT Cryo-Spots. 3/8" diam., 1,000/roll BLUE	Labels	5	50165.00	CLSLCRY-1100-Y	Laser Cryo-Tags 1.69 x 0.75" Yellow	Labels	5	46200.00
CLSDTCR-4002	DT Cryo-Spots. 3/8" diam., 1,000/roll GREEN	Labels	5	50165.00	CLSLCRY-1200	Laser Cryo-Tags 1.50 x 0.75" 1,200/pk	Labels	5	46200.00
CLSDTCR-4003	DT Cryo-Spots. 3/8" diam., 1,000/roll YELLOW	Labels	5	50165.00	CLSLCRY-1200-B	Laser Cryo-Tags 1.50 x 0.75" Blue	Labels	5	46200.00
CLSDTCR-5000	DT Cryo-Tags 2.00" x 0.25" 1,000/roll WHITE	Labels	5	64083.50	CLSLCRY-1200-G	Laser Cryo-Tags 1.50 x 0.75" Green	Labels	5	46200.00
CLSDTCR-6000	DT Cryo-Tag 1.50" x .50" and 3/8" Cryo Spot Combo 500 sets/roll	Labels	5	44660.00	CLSLCRY-1200-O	Laser Cryo-Tags 1.50 x 0.75" Orange	Labels	5	46200.00
CLSDTCR-6000-B	DT Cryo-Tag 1.50" x .50" and 3/8" Cryo Spot Combo 500 sets/roll	Labels	5	44660.00	CLSLCRY-1200-R	Laser Cryo-Tags 1.50 x 0.75" Red	Labels	5	46200.00
CLSDTCR-6000-G	DT Cryo-Tag 1.50" x .50" and 3/8" Cryo Spot Combo 500 sets/roll	Labels	5	44660.00	CLSLCRY-1200-Y	Laser Cryo-Tags 1.50 x 0.75" Yellow	Labels	5	46200.00
CLSDTCR-6000-Y	DT Cryo-Tag 1.50" x .50" and 3/8" Cryo Spot Combo 500 sets/roll	Labels	5	44660.00	CLSLCRY-1258	Laser Cryo-Tags 2.625 x 1.00" 600/pk	Labels	5	46200.00
CLSDYMO-0450	Dymo Label Writer 450	Printer	5	324000.00	CLSLCRY-1258-B	Laser Cryo-Tags 2.625 x 1.00" 600/pk Blue	Labels	5	46200.00
CLSLFLAG-1000	Laser Flag Tough-Tags 2.50 x 0.50" 1,500/pk	Labels	5	52580.00	CLSLCRY-1258-G	Laser Cryo-Tags 2.625 x 1.00" 600/pk Green	Labels	5	46200.00
CLSGM-100	Flow Mesh, 20 sheets	Gel Related	5	39600.00	CLSLCRY-1258-O	Laser Cryo-Tags 2.625 x 1.00" 600/pk Orange	Labels	5	46200.00
CLSGFRK-100	Fluorescent Ruler Kit	Gel Related	5	23285.00	CLSLCRY-1258-R	Laser Cryo-Tags 2.625 x 1.00" 600/pk Red	Labels	5	46200.00
CLSGH-100	Gel Handler, 5 mil thick - 10 shts	Gel Related	5	31315.00	CLSLCRY-1258-Y	Laser Cryo-Tags 2.625 x 1.00" 600/pk Yellow	Labels	5	46200.00
CLSGH-200	Gel Handler, 10 mil thick - 5 shts	Gel Related	5	31315.00	CLSLCRY-1300	Laser Cryo-Tags 1 1/8 x 1 3/4" 840/pk	Labels	5	46200.00
CLSGLWR-1000	Glow-Writer Pen	Gel Related	5	48180.00	CLSLCRY-1400	Laser Cryo-Babies 1.0" x 1.0" 1,600/pk	Labels	5	46200.00
CLSGNIB-1000	Glow Writer Nibs, 4/pack	Gel Related	5	8030.00	CLSLCRY-1700	Laser Cryo-Babies 1.28 x 0.50" 1,700/pk	Labels	5	46200.00
CLSGOO-100	Goo-Off, lemon scented - 1 oz.	Laboratory Cleaning Solutions	5	6390.00	CLSLCRY-1700-B	Laser Cryo-Babies 1.28 x 0.50" Blue	Labels	5	46200.00
CLSGOO-200	Goo-Off, lime scented - 1 oz.	Laboratory Cleaning Solutions	5	6390.00	CLSLCRY-1700-G	Laser Cryo-Babies 1.28 x 0.50" Green	Labels	5	46200.00
CLSGOO-300	Goo-Off, cherry scented - 1 oz.	Laboratory Cleaning Solutions	5	6390.00	CLSLCRY-1700-O	Laser Cryo-Babies 1.28 x 0.50" Orange	Labels	5	46200.00
CLSGRDT-1000	DT WetGrip 1.05 x 0.50" 1,000/roll	Labels	5	36190.00	CLSLCRY-1700-R	Laser Cryo-Babies 1.28 x 0.50" Red	Labels	5	46200.00
CLSGRDT-2000	DT WetGrip 1.50 x 0.50" 750/roll	Labels	5	38500.00	CLSLCRY-1700-Y	Laser Cryo-Babies 1.28 x 0.50" Yellow	Labels	5	46200.00
CLSGRDT-3000	DT WetGrip 1.50 x 0.75" 750/roll	Labels	5	34650.00	CLSLCRY-2380	Laser Cryo-Babies 0.94 x 0.50" 2,380/pk	Labels	5	46200.00
CLSGRDT-4000	DT WetGrip 3/8" diam., 1,000/roll	Labels	5	52475.00	CLSLCRY-2380-B	Laser Cryo-Babies 0.94 x 0.50" Blue	Labels	5	46200.00
CLSGRDT-5000	DT WetGrip 2.00" x 0.25" 1,000/roll	Labels	5	60934.50	CLSLCRY-2380-G	Laser Cryo-Babies 0.94 x 0.50" Green	Labels	5	46200.00
CLSGRDT-6000	DT WetGrip 1.50" x .50" and 3/8" Tough Spot Combo 500 sets/roll	Labels	5	46200.00	CLSLCRY-2380-O	Laser Cryo-Babies 0.94 x 0.50" Orange	Labels	5	46200.00
CLSGRID-1000	Slide Grids, 20mm x 20mm	Microscopy	5	25564.00	CLSLCRY-2380-R	Laser Cryo-Babies 0.94 x 0.50" Red	Labels	5	46200.00
CLSGRLA-1000	Microscope Slide WetGrip 7/8" x 7/8" 2,400/pk	Labels	5	52475.00	CLSLCRY-2380-Y	Laser Cryo-Babies 0.94 x 0.50" Yellow	Labels	5	46200.00
CLSGRLA-1050	Laser WetGrip 1.50 x 0.75" 1,500/pk	Labels	5	52475.00	CLSLCRY-2500	Laser Cryo-Tags 2.50" x 0.50" 1,200/pk	Labels	5	46200.00
CLSGRLA-2016	Laser WetGrip 1.28 x 0.50" 1,700/pk	Labels	5	52475.00	CLSLCRY-3020	Laser Cryo-Tags 3.0 x 2.0" 240/pk	Labels	5	46200.00
CLSGRLA-2380	Laser WetGrip 0.94 x 0.50" 2,380/pk	Labels	5	52475.00	CLSLTBK-1000	Light-Bloc Labels 4.75" x 2.25" 100/roll	Labels	5	30800.00
CLSGRRL-1000	WetGrip 1.28 x 0.50" 1,000/roll	Labels	5	26950.00	CLSLTBK-2000	Light-Bloc Labels 4.75" x 3.75" 100/roll	Labels	5	34650.00
CLSGRRL-2000	WetGrip 1.50 x 0.75" 1,000/roll	Labels	5	26950.00	CLSLTTI-1000	Laser Tough-Tags 1.00 x 1.00" 1,600/pk	Labels	5	50160.00
CLSGUIDE-300	Pipetter Guide, single place	Microwell Plate Accessories	5	202860.00	CLSLTTI-2000	Laser Tough-Tags 1 5/8 x 5/8" 1,600/pk	Labels	5	50160.00
CLSGUIDE-400	Pipetter Guide, double place	Microwell Plate Accessories	5	203933.50	CLSLTTM-1000	Laser Teeny Tough-Tags 0.91 x 0.32" 3,850/pk	Labels	5	50160.00
CLSHALF-1000	Clear over White Laser Tough-Tags 520/pk	Labels	5	52550.00	CLSMINI-1700	Mini Laser Cryo-Babies 1.28" x 0.50", 1,020/pk	Labels	5	36190.00
CLSHOTS-1000	HotSeal, 100/pk	Sealing Film	5	54780.00	CLSMISL-1000	Microscope Slide Tough-Tags 7/8" x 7/8" 2,400/pk	Labels	5	50160.00
CLSBUC-1000	2.5 Liter Triple Density Ice Bucket Icy Blue	Ice Pan Ice Bucket	5	26950.00	CLSMISL-1000-B	Microscope Slide Tough-Tags, Blue	Labels	5	50160.00
CLSBUC-1100	2.5 Liter Triple Density Ice Bucket Icy Green	Ice Pan Ice Bucket	5	26950.00	CLSMISL-1000-G	Microscope Slide Tough-Tags, Green	Labels	5	50160.00
CLSBUC-2000	5 Liter Triple Density Ice Bucket Icy Blue	Ice Pan Ice Bucket	5	34650.00	CLSMISL-1000-O	Microscope Slide Tough-Tags, Orange	Labels	5	50160.00
CLSBUC-2100	5 Lite Triple Density Ice Bucket, Icy Green	Ice Pan Ice Bucket	5	34650.00	CLSMISL-1000-R	Microscope Slide Tough-Tags, Red	Labels	5	50160.00
CLSID-100	Identi-Kit, 174 symbols	Gel Related	5	31955.00	CLSMISL-1000-Y	Microscope Slide Tough-Tags, Yellow	Labels	5	50160.00
CLSPAN-1000	1 Liter Triple Density Ice Pan Icy Blue	Ice Pan Ice Bucket	5	11550.00	CLSMIWE-1000	Slide Wells, 0.25mm thick	Microscopy	5	38720.00
CLSPAN-1100	1 Liter Triple Density Ice Pan Icy Green	Ice Pan Ice Bucket	5	11550.00	CLSMIWE-2000	Slide Wells, 0.50mm thick	Microscopy	5	47080.00
CLSPAN-2000	4 Liter Triple Density Ice Pan Icy Blue	Ice Pan Ice Bucket	5	26950.00	CLSNEW-100	New Ice, 45/pack	Reusable Ice Packs	5	8580.00
CLSPAN-2100	4 Liter Triple Density Ice Pan Icy Green	Ice Pan Ice Bucket	5	26950.00	CLSNOC-1000	NovaChamber, red	Rack	5	56100.00
CLSPAN-3000	9 Liter Triple Density Ice Pan Icy Blue	Ice Pan Ice Bucket	5	37730.00	CLSNOC-2000	NovaChamber, teal	Rack	5	56100.00
CLSPAN-3100	9 Liter Triple Density Ice Pan Icy Green	Ice Pan Ice Bucket	5	37730.00	CLSNOC-3000	NovaChamber, yellow	Rack	5	56100.00
CLSLBTP-1000	Labeling Tape, White 3/4" x 500"/Roll	Tape	5	8085.00	CLSNOC-4000	NovaChamber, pink	Rack	5	56100.00
CLSLBTP-1100	Labeling Tape, Yellow 3/4" x 500"/Roll	Tape	5	8085.00	CLSNOC-5000	NovaChamber, purple	Rack	5	56100.00
CLSLBTP-1200	Labeling Tape, Green 3/4" x 500"/ Roll	Tape	5	8085.00	CLSNORC-1000	NovaRack, red	Rack	5	39600.00
CLSLBTP-1300	Labeling Tape, Blue 3/4" x 500"/ Roll	Tape	5	8085.00	CLSNORC-2000	NovaRack, teal	Rack	5	39600.00
CLSLBTP-1400	Labeling Tape, Red 3/4" x 500" / Roll	Tape	5	8085.00	CLSNORC-3000	NovaRack, yellow	Rack	5	39600.00
CLSLBTP-2000	Labeling Tape, White 3/4" x 2,160"/Roll	Tape	5	24640.00	CLSNORC-4000	NovaRack, pink	Rack	5	39600.00
CLSLBTP-2100	Labeling Tape, Yellow 3/4" x 2,160"/Roll	Tape	5	24640.00	CLSNORC-5000	NovaRack, purple	Rack	5	39600.00
					CLSNOST-1000	NovaRack stacking adapter	Rack	5	8580.00
					CLSPDHL-1000	Petri Dish Support N Seal	Petri Dish Accessories	5	43305.00
					CLSPDOR-1032	PetriOrientor, 32-square grid	--	5	12045.00
					CLSPDOR-1050	PetriOrientor, 50-square grid	--	5	12045.00



Code	Product Description	Label	Pk Size	Price	Code	Product Description	Label	Pk Size	Price
CLSPDOR-1070	PetriOrienter, 70-square grid	--	5	12045.00	CLSRNBW-2400	Rainbow Pack for SIDE-1000	Labels	5	46200.00
CLSPDOR-1100	PetriOrienter, 100-square grid	--	5	12045.00	CLSRNBW-2500	Rainbow Pack for LCRY-1258	Labels	5	46200.00
CLSPDOR-2006	PetriOrienter, 6-sector pie	--	5	12045.00	CLSRNBW-3000	Rainbow 1.28 x 0.50" Laser Tough-Tags	Labels	5	50160.00
CLSPDOR-2008	PetriOrienter, 8-sector pie	--	5	12045.00	CLSRNBW-3100	Rainbow 0.94 x 0.50" Laser Tough-Tags	Labels	5	50160.00
CLSPDOR-2012	PetriOrienter, 12-sector pie	--	5	12045.00	CLSRNBW-3200	Rainbow 1.50 x 0.75" Laser Tough-Tags	Labels	5	50160.00
CLSPDOR-2016	PetriOrienter, 16-sector pie	--	5	12045.00	CLSRNBW-3300	Rainbow Microscope Slide Tough-Tags	Labels	5	50160.00
CLSPDST-1000	PetriDish Stand 88mm diameter	--	5	45650.00	CLSRock-1000	Rocker Tape on a roll, 1.50" x 20'	Tapes	5	26400.00
CLSPDST-2000	PetriDish Stand 100mm diameter	--	5	45650.00	CLSRock-2000	Rocker Tape Sheets, 12" x 12", 3/pk	Tapes	5	31680.00
CLSPeel-1000	Breathable Peel-n-Seal, 1.50" dia. 250ml Flask 50/pack	Sealing Film	5	27390.00	CLSRsPO-1000	Printed Tough-Spots, 1 to 10	Labels	5	19250.00
CLSPeel-1100	Breathable Peel-n-Seal, 1.63" dia. 500ml Flask 50/pack	Sealing Film	5	27390.00	CLSRsPO-2000	Printed Tough-Spots, 1 to 100	Labels	5	19250.00
CLSPeel-1101	Breathable Peel-n-Seal, 2.13" dia. 500ml Flask 50/pack	Sealing Film	5	27390.00	CLSRsPO-3000	Printed Tough-Spots for microplates	Labels	5	19250.00
CLSPeel-2000	Non-breathable Peel-n-Seal, 1.50" dia. 50/pack	Sealing Film	5	27390.00	CLSRWTS-1000	3/8" Radioactive Warning Tough-Spots 1,000/roll	Labels	5	19250.00
CLSPeel-2100	Non-breathable Peel-n-Seal, 1.63" dia. 50/pack	Sealing Film	5	27390.00	CLSSCS-1	3/4" Binder Clips, 10/pk	Gel Related	5	21780.00
CLSPeel-2200	Non-breathable Peel-n-Seal, 2.13" dia. 50/pack	Sealing Film	5	27390.00	CLSSCS-3	2" Binder Clips, 8/pk	Gel Related	5	32670.00
CLSPICK-1000	Toothpick Dispenser w/polypropylene case	Cell Culture Control System Accessories	5	45650.00	CLSSett-1000	SlenderEdge Laser Tough-Tags, 2,475/pk	Labels	5	50160.00
CLSPICK-2000	Kokeshi Style Toothpicks, 350/pk.	Cell Culture Control System Accessories	5	4950.00	CLSSFBK-0250	250ml Sure-Footed Thermo-Beaker, 50/cs	--	5	63910.00
CLSPSeal-108B	PetriSEAL, blue	PetriDish Accessories	5	27390.00	CLSSIDE-1000	Laser Sidewall Cryo-Tags 1.50 x 0.25" 3,120/pk	Labels	5	46200.00
CLSPSeal-108C	PetriSEAL, clear	PetriDish Accessories	5	27390.00	CLSSIDE-1100	Laser Sidewall Cryo-Tags 1.50 x 0.25" Blue	Labels	5	46200.00
CLSPSeal-108R	PetriSEAL, red	PetriDish Accessories	5	27390.00	CLSSIDE-1200	Laser Sidewall Cryo-Tags 1.50 x 0.25" Green	Labels	5	46200.00
CLSPSeal-108W	PetriSEAL, white	PetriDish Accessories	5	27390.00	CLSSIDE-1300	Laser Sidewall Cryo-Tags 1.50 x 0.25" Orange	Labels	5	46200.00
CLSPSeal-108Y	PetriSEAL, yellow	PetriDish Accessories	5	27390.00	CLSSIDE-1400	Laser Sidewall Cryo-Tags 1.50 x 0.25" Red	Labels	5	46200.00
CLSPSTK-1000	PetriStickers, 32-square grid 36/pk	PetriDish Accessories	5	15975.00	CLSSIDE-1500	Laser Sidewall Cryo-Tags 1.50 x 0.25" Yellow	Labels	5	46200.00
CLSPSTK-1050	PetriStickers, 50-square grid 36/pk	PetriDish Accessories	5	15975.00	CLSSORB-1000	Lab-Sorb 16 oz jar	Waste Disposal	5	28105.00
CLSPSTK-1070	PetriStickers, 70-square grid 36/pk	PetriDish Accessories	5	15975.00	CLSSORB-2000	Kit (Includes Lab-Sorb 16 oz jar plus small bags (25)	Waste Disposal	5	40150.00
CLSPSTK-1100	PetriStickers, 100-square grid 36/pk	PetriDish Accessories	5	15975.00	CLSSORB-2100	Kit (Includes Lab-Sorb 16 oz jar plus medium bags (25)	Waste Disposal	5	40150.00
CLSPSTK-2000	PetriStickers, 6-sector pie 36/pk	PetriDish Accessories	5	15975.00	CLSSORB-2200	Kit Includes Lab-Sorb 16 oz jar plus Large bags	Waste Disposal	5	40150.00
CLSPSTK-2010	PetriStickers, 8-sector pie 36/pk	PetriDish Accessories	5	15975.00	CLSSORB-2300	Variety kit Lab-sorb plus variety size bags (15sm, 10md, 5lg)	Waste Disposal	5	40150.00
CLSPSTK-2020	PetriStickers, 12-sector pie 36/pk	PetriDish Accessories	5	15975.00	CLSSORB-3000	50 small bags	Waste Disposal	5	40150.00
CLSPSTK-2030	PetriStickers, 16-sector pie 36/pk	PetriDish Accessories	5	15975.00	CLSSORB-3100	50 medium bags	Waste Disposal	5	24090.00
CLSPSTK-3000	PetriStickers, 3 Color Grid 18/pk	PetriDish Accessories	5	14300.00	CLSSORB-3200	50 large bags	Waste Disposal	5	24090.00
CLSRAD-10	Radtape, 4" x 6" - 10/pk	Gel Related	5	51040.00	CLSSPOT-1000	3/8" Laser Tough-Spots, White 3,840/pk	Labels	5	24090.00
CLSRCS-50	Rapid Coomassie Stain, 100ml	Gel Staining	5	83600.00	CLSSPOT-1100	3/8" Laser Tough Spots, Blue	Labels	5	46200.00
CLSRBP-1000	Bio-Pure 100 ml Biodegradable Reservoir-Sterile	Reagent Reservoir	5	73040.00	CLSSPOT-1200	3/8" Laser Tough-Spots, Green	Labels	5	46200.00
CLSRBP-2000	Bio-Pure 25ml w/divider Biodegradable Reservoir-Sterile	Reagent Reservoir	5	59345.00	CLSSPOT-1300	3/8" Laser Tough-Spots, Orange	Labels	5	46200.00
CLSRBP-3000	Bio-Pure 25ml Biodegradable Reservoir- Sterile	Reagent Reservoir	5	59345.00	CLSSPOT-1400	3/8" Laser Tough-Spots, Red	Labels	5	46200.00
CLSRBP-5000	Bio-Pure 50ml Biodegradable Reservoir - Sterile	Reagent Reservoir	5	73040.00	CLSSPOT-1500	3/8" Laser Tough-Spots, Yellow	Labels	5	46200.00
CLSRSE-1000	100ml Reservoir, 100/case, sterile	Reagent Reservoir	5	70300.00	CLSSPOT-2000	1/2" Laser Tough-Spots 3,840/pk	Labels	5	46200.00
CLSRSE-1050	100ml Reservoir, 50 individually wrapped, sterile	Reagent Reservoir	5	62540.00	CLSSPOT-2100	1/2" Laser Tough-Spots, Blue	Labels	5	46200.00
CLSRSE-1100	100ml Reservoir, 100/case, Non-sterile	Reagent Reservoir	5	65120.00	CLSSPOT-2200	1/2" Laser Tough-Spots, Green	Labels	5	46200.00
CLSRSE-2000	25ml Reservoir with divider, 100/case, sterile	Reagent Reservoir	5	60255.00	CLSSPOT-2300	1/2" Laser Tough-Spots, Orange	Labels	5	46200.00
CLSRSE-2050	25ml Reservoir with divider, 50 individually wrapped, sterile	Reagent Reservoir	5	52955.00	CLSSPOT-2400	1/2" Laser Tough-Spots, Red	Labels	5	46200.00
CLSRSE-2100	25ml Reservoir with divider, 100/case, Non-sterile	Reagent Reservoir	5	51040.00	CLSSPOT-2500	1/2" Laser Tough-Spots, Yellow	Labels	5	46200.00
CLSRSE-3000	25ml Reservoir, 100/case, sterile	Reagent Reservoir	5	60258.00	CLSSPOT-3000	3/4" Laser Tough-Spots 2,160/pk	Labels	5	46200.00
CLSRSE-3050	25ml Reservoir, 50 individually wrapped, sterile	Reagent Reservoir	5	54560.00	CLSSPOT-4000	1.00" Laser Tough-Spots 1,260/pk	Labels	5	46200.00
CLSRSE-3100	25ml Reservoir 100/case, Non-sterile	Reagent Reservoir	5	51040.00	CLSSPOT-5000	7/16" Laser Tough-Spots 4,680/pk	Labels	5	46200.00
CLSRSE-4000	100ml Sidecar Reservoir, 100/case, sterile	Reagent Reservoir	5	74865.00	CLSSPRL-1000	3/8" Tough-Spots , 5-up 5,000/roll	Labels	5	76615.00
CLSRSE-4050	100ml Sidecar Reservoir, 50 individually wrapped, sterile	Reagent Reservoir	5	67560.00	CLSSPRL-1100	3/8" Tough-Spots, 5-up Assorted Colors 5,000/roll	Labels	5	76615.00
CLSRSE-4100	100ml Sidecar Reservoir, 100/case, Non-sterile	Reagent Reservoir	5	65120.00	CLSSPRL-2000	1/2" Tough-Spots, 5-up 5,000/roll	Labels	5	76615.00
CLSRSE-5000	50ml Reservoir, 100/case, sterile	Reagent Reservoir	5	70300.00	CLSSPRL-2100	1/2" Tough-Spots, 5-up Assorted Colors 5,000/roll	Labels	5	76615.00
CLSRSE-5050	50ml Reservoir, 50 Individually wrapped, sterile	Reagent Reservoir	5	62084.00	CLSSTK-57R	Sticky Stand, regular 5" x 7"	Test tube accessories	5	31315.00
CLSRSE-5100	50ml Reservoir, 100/case, Non-sterile	Reagent Reservoir	5	60255.00	CLSSTK-57SS	Sticky Stand, super 5" x 7"	Test tube accessories	5	31315.00
CLSRSE-C025	Cooler for 25ml Reservoir	Reagent Reservoir	5	27390.00	CLSSUE-100	Sweet Sue, balsam fir, 10/pk	Odor Control Products	5	12848.00
CLSRSE-C050	Cooler for 50ml Reservoir	Reagent Reservoir	5	27390.00	CLSSUE-200	Sweet Sue, wild cherry, 10/pk	Odor Control Products	5	12848.00
CLSRSE-C100	Cooler for 100ml Reservoir	Reagent Reservoir	5	27390.00	CLSSUE-300	Sweet Sue, sage & citrus, 10/pk	Odor Control Products	5	12848.00
CLSRest-1000	Angled Bottle Rest	Microwell Plate Accessories	5	59935.00	CLSSUE-400	Sweet Sue for animal facilities, 10/pk	Odor Control Products	5	12848.00
CLSRNBW-1000	Rainbow Pack for SPOT-1000	Labels	5	46200.00	CLSSUEP-1000	Sweet Sue Pouch, 6/pk	Odor Control Products	5	3575.00
CLSRNBW-1100	Rainbow Pack for SPOT-2000	Labels	5	46200.00	CLSSYN-100	Synergel, 100g	Gel Related	5	87120.00
CLSRNBW-2000	Rainbow Pack for LCRY-1100	Labels	5	46200.00	CLSTH-20	Thirsty Stix, 6.0" x 0.20"	Absorbent Materials	5	22825.00
CLSRNBW-2100	Rainbow Pack for LCRY-1200	Labels	5	46200.00	CLSTHER-1094	TT Tough-Tags 0.94 x 0.50" 2,000/roll	Labels	5	56980.00
CLSRNBW-2200	Rainbow Pack for LCRY-1700	Labels	5	46200.00	CLSTHER-1128	TT Tough-Tags 1.28 x 0.50" 2,000/roll	Labels	5	63910.00
CLSRNBW-2300	Rainbow Pack for LCRY-2380	--	5	46200.00	CLSTHER-1137	TT Tough-Tags 1.375 x 0.625" 2,000/roll	Labels	5	63910.00
					CLSTHER-1150	TT Tough-Tags 1.50 x 0.75" 2,000/roll	Labels	5	165005.00
					CLSTHER-1225	TT Tough-Tags 2.0 x 0.25" 2,000/roll	Labels	5	63910.00
					CLSTHER-3094	TT Tough-Tags 0.94 x 0.50" 4,000/roll	Labels	5	173935.00



Code	Product Description	Label	Pk Size	Price	Code	Product Description	Label	Pk Size	Price
CLSTHER-3128	TT Tough-Tags 1.28 x 0.50" 4,000/roll	Labels	5	191080.00	CLSTTLW-2016-Y	Laser Tough-Tags 1.28 x 0.50" 2,125/pk, Yellow	Labels	5	50160.00
CLSTHER-3096	TT Tough-Tags 1.375 x 0.625" 4,000/roll	Labels	5	191080.00	CLSTTLW-KK-20	KissCut Tough-Tags 1.28 x 0.50" 2,520/pk	Labels	5	50160.00
CLSTHER-3097	TT Tough-Tags 1.50 x 0.75" 4,000/roll	Labels	5	105460.00	CLSTTLY-1000	Tough-Tags 1.28 x 0.50" Yellow	Labels	5	26755.00
CLSTHER-3225	TT Tough-Tags 2.0 x 0.25" 4,000/roll	Labels	5	192973.00	CLST-TOPS-100	Titer Tops, 100/pk	Sealing Film	5	54780.00
CLSTHPR-4000	Zebra GK420T Thermal Transfer Printer	Printer	1	253440.00	CLST-TOPS-50	Titer Tops, 50/pk	Sealing Film	5	31955.00
CLSTHRI-5000	Resin Ribbon 2.50" x 244' for TLP 2844	Printer Supplies	5	20460.00	CLSTTSA-9000	Tough-Tag Station	Label Accessories	5	51040.00
CLSTHUM-1000	0.5ml Thumbs-Up, Clear 1000/pack	Microtubes	5	52800.00	CLSTTSB-1000	Tough-Tags 0.94 x 0.50" Blue	Labels	5	23100.00
CLSTHUM-1100	0.5ml Thumbs-Up, Blue 1000/pack	Microtubes	5	52800.00	CLSTTSC-1000	Tough-Tags 0.94 x 0.50" Clear	Labels	5	23100.00
CLSTHUM-1200	0.5ml Thumbs-Up, Green 1000/pack	Microtubes	5	52800.00	CLSTTSG-1000	Tough-Tags 0.94 x 0.50" Green	Labels	5	23100.00
CLSTHUM-1300	0.5ml Thumbs-Up, Pink 1000/pack	Microtubes	5	52800.00	CLSTTSH-1000	Laser Tough-Tag sheet, 25/pk	Labels	5	48510.00
CLSTHUM-1400	0.5ml Thumbs-Up, Purple 1000/pack	Microtubes	5	52800.00	CLSTTSO-1000	Tough-Tags 0.94 x 0.50" Orange	Labels	5	23100.00
CLSTHUM-1500	0.5ml Thumbs-Up, Yellow 1000/pack	Microtubes	5	52800.00	CLSTTSR-1000	Tough-Tags 0.94 x 0.50" Red	Labels	5	23100.00
CLSTHUM-2000	1.5ml Thumbs-Up, Clear 500/pack	Microtubes	5	27390.00	CLSTTSW-1000	Tough-Tags 0.94 x 0.50" 1,000/roll	Labels	5	23100.00
CLSTHUM-2100	1.5ml Thumbs-Up, Blue 500/pack	Microtubes	5	27390.00	CLSTTSW-2240	Laser Tough-Tags 0.94 x 0.50" 2,975/pk	Labels	5	50380.00
CLSTHUM-2200	1.5ml Thumbs-Up, Green 500/pack	Microtubes	5	27390.00	CLSTTSW-2240-B	Laser Tough-Tags 0.94 x 0.50" 2,975/pk, Blue	Labels	5	50380.00
CLSTHUM-2300	1.5ml Thumbs-Up, Pink 500/pack	Microtubes	5	27390.00	CLSTTSW-2240-G	Laser Tough-Tags 0.94 x 0.50" 2,975/pk, Green	Labels	5	50380.00
CLSTHUM-2400	1.5ml Thumbs-Up, Purple 500/pack	Microtubes	5	27390.00	CLSTTSW-2240-O	Laser Tough-Tags 0.94 x 0.50" 2,975/pk, Orange	Labels	5	50380.00
CLSTHUM-2500	1.5ml Thumbs-Up, Yellow 500/pack	Microtubes	5	27390.00	CLSTTSW-2240-R	Laser Tough-Tags 0.94 x 0.50" 2,975/pk, Red	Labels	5	50380.00
CLSTNY-TWIN	Twin-Tip Teeny Writer, black	Laboratory Marker	5	4993.00	CLSTTSW-2240-Y	Laser Tough-Tags 0.94 x 0.50" 2,975/pk, Yellow	Labels	5	50380.00
CLSTNY-WTR	Teeny Writer, black	Laboratory Marker	5	4993.00	CLSTT-SWALL	Sidewall Tough-Tags 1.50 x 0.25" 1,000/roll	Labels	5	23100.00
CLST-SPOTS	3/8" Tough-Spots 1,000/roll	Labels	5	19250.00	CLSTTSG-KK-20	KissCut Tough-Tags 0.94 x 0.50" 3,200/pk	Labels	5	46200.00
CLST-SPOTS-100	1.00" Tough-Spots 500/roll	Labels	5	21829.00	CLSTTSY-1000	Tough-Tags 0.94 x 0.50" Yellow	Labels	5	21560.00
CLST-SPOTS-44	7/16" Tough-Spots 1,000/roll	Labels	5	19250.00	CLSTT-TNY	Teeny Tough-Tags 0.81 x 0.28" 1,500/roll	Labels	5	21560.00
CLST-SPOTS-50	1/2" Tough-Spots 1,000/roll	Labels	5	19250.00	CLSVIBE-1000	7" x 8.5", 2/pk	Vibration Dampening	5	21560.00
CLST-SPOTS-50B	1/2" Tough-Spots, Blue	Labels	5	19250.00	CLSVIBE-2000	8.5" x 11" 2/pk	Vibration Dampening	5	31955.00
CLST-SPOTS-50C	1/2" Tough-Spots, Coffee	Labels	5	19250.00	CLSVIBE-3000	Combo Pack, 2/pk	Vibration Dampening	5	31955.00
CLST-SPOTS-50D	1/2" Tough-Spots, Gold	Labels	5	19250.00	CLSWASH-1000	Wash-Off Labels 2.625" x 1.00" 750/pk	Labels	5	91520.00
CLST-SPOTS-50G	1/2" Tough-Spots, Green	Labels	5	19250.00	CLSWASH-2000	Wash-Off Labels 4.00" x 1.00" 500/pk	Labels	5	91520.00
CLST-SPOTS-50L	1/2" Tough-Spots, Lavender	Labels	5	19250.00	CLSWASH-3100	1"x1" /25mm x 25mm 250/roll Warning: Flammable	Label	5	30800.00
CLST-SPOTS-50M	1/2" Tough-Spots, Maroon	Labels	5	19250.00	CLSWASH-3200	1"x1" /25mm x 25mm 250/roll Warning: Poison	Label	5	30800.00
CLST-SPOTS-50O	1/2" Tough-Spots, Orange	Labels	5	19250.00	CLSWASH-3300	1"x1" /25mm x 25mm 250/roll Warning: Biohazard	Label	5	30800.00
CLST-SPOTS-50P	1/2" Tough-Spots, Pink	Labels	5	19250.00	CLSWASH-3400	1"x1" /25mm x 25mm 250/roll Warning: Corrosive	Label	5	30800.00
CLST-SPOTS-50R	1/2" Tough-Spots, Red	Labels	5	19250.00	CLSWASH-3500	1"x1" /25mm x 25mm 250/roll Warning: Radioactive	Label	5	30800.00
CLST-SPOTS-50S	1/2" Tough-Spots, Silver	Labels	5	19250.00	CLSWASH-3600	1"x1" /25mm x 25mm 250/roll Warning: Ready for Use	Label	5	30800.00
CLST-SPOTS-50Y	1/2" Tough-Spots, Yellow	Labels	5	19250.00	CLSWASH-3700	1"x1" /25mm x 25mm 250/roll Warning: Do Not Use	Label	5	30800.00
CLST-SPOTS-75	3/4" Tough-Spots 500/roll	Labels	5	21829.00	CLSWASH-4100	3.00"x2.00" / 76mm x 51mm 250/roll Warning: Flammable	Label	5	38500.00
CLST-SPOTS-B	3/8" Tough-Spots, Blue	Labels	5	19250.00	CLSWASH-4200	3.00"x2.00" / 76mm x 51mm 250/roll Warning: Poison	Label	5	38500.00
CLST-SPOTS-C	3/8" Tough-Spots, Coffee	Labels	5	19250.00	CLSWASH-4300	3.00"x2.00" / 76mm x 51mm 250/roll Warning: Biohazard	Label	5	38500.00
CLST-SPOTS-D	3/8" Tough-Spots, Gold	Labels	5	19250.00	CLSWASH-4400	3.00"x2.00" / 76mm x 51mm 250/roll Warning: Corrosive	Label	5	38500.00
CLST-SPOTS-G	3/8" Tough-Spots, Green	Labels	5	19250.00	CLSWASH-4500	3.00"x2.00" / 76mm x 51mm 250/roll Warning: Radioactive	Label	5	38500.00
CLST-SPOTS-L	3/8" Tough-Spots, Lavender	Labels	5	19250.00	CLSWASH-4600	3.00"x2.00" / 76mm x 51mm 250/roll Warning: Ready for Use	Label	5	38500.00
CLST-SPOTS-M	3/8" Tough-Spots, Maroon	Labels	5	19250.00	CLSWASH-4700	3.00"x2.00" / 76mm x 51mm 250/roll Warning: Do Not Use	Label	5	38500.00
CLST-SPOTS-O	3/8" Tough-Spots, Orange	Labels	5	19250.00	CLSWELL-1000	96 Well Orienter, 4/pk	Microwell Plate Accessories	5	20075.00
CLST-SPOTS-P	3/8" Tough-Spots, Pink	Labels	5	19250.00	CLSWELL-2000	48 Well Orienter, 4/pk	Microwell Plate Accessories	5	20075.00
CLST-SPOTS-R	3/8" Tough-Spots, Red	Labels	5	19250.00	CLSWELL-3000	24 Well Orienter, 4/pk	Microwell Plate Accessories	5	20075.00
CLST-SPOTS-S	3/8" Tough-Spots, Silver	Labels	5	19250.00	CLSWELL-384H	Multi-colored 384 Well Orienter, 2/pk	Microwell Plate Accessories	5	24090.00
CLST-SPOTS-Y	3/8" Tough-Spots, Yellow	Labels	5	19250.00	CLSWELL-384V	Multi-colored 384 Well Orienter, 2/pk	Microwell Plate Accessories	5	24090.00
CLSTS-TNY	3/16" Tough-Spots, White 1,500/roll	Labels	5	32340.00	CLSWELL-96H	Multi-colored 96 Well Orienter, 2/pk	Microwell Plate Accessories	5	24090.00
CLSTTGP-1000	Tough-Tags 1.50 x 0.75" 1,000/roll	Labels	5	36190.00	CLSWELL-96V	Multi-colored 96 Well Orienter, 2/pk	Microwell Plate Accessories	5	24090.00
CLSTTGP-1050	Laser Tough-Tags 1.50 x 0.75" 1,500/pk	Labels	5	50160.00	CLSWEST-1000	96-Well Orienter Stickers, 50/pk	Microwell Plate Accessories	5	23285.00
CLSTTGP-1050-B	Laser Tough-Tags 1.50 x 0.75" 1,500/pk, Blue	Labels	5	50160.00	CLSWIPE-1000	Tough Wipes, 50/Bottle	Laboratory Cleaning Solutions	5	18260.00
CLSTTGP-1050-G	Laser Tough-Tags 1.50 x 0.75" 1,500/pk, Green	Labels	5	50160.00	CLSWPAJ-1000	Adjustable Well Plate Stand	Microwell Plate Accessories	5	65120.00
CLSTTGP-1050-O	Laser Tough-Tags 1.50 x 0.75" 1,500/pk, Orange	Labels	5	50160.00	CLSWPNP-1000	96 Well Pad, 50 sheets	Microwell Plate Accessories	5	10955.00
CLSTTGP-1050-R	Laser Tough-Tags 1.50 x 0.75" 1,500/pk, Red	Labels	5	50160.00	CLSWPNP-2000	48 Well Pad, 50 sheets	Microwell Plate Accessories	5	10955.00
CLSTTGP-1050-Y	Laser Tough-Tags 1.50 x 0.75" 1,500/pk, Yellow	Labels	5	50160.00	CLSWPNP-3000	24 Well Pad, 50 sheets	Microwell Plate Accessories	5	10955.00
CLSTTLB-1000	Tough-Tags 1.28 x 0.50" Blue	Labels	5	26757.50	CLSWPST-1000	Well Plate Stand	Microwell Plate Accessories	5	31955.00
CLSTTLC-1000	Tough-Tags 1.28 x 0.50" Clear	Labels	5	26757.50	CLSWPST-2000	Dual Microplate Stand, angled	Microwell Plate Accessories	5	57200.00
CLSTTLG-1000	Tough-Tags 1.28 x 0.50" Green	Labels	5	26757.50	CLSWPST-3000	Dual Microplate Stand, lat	Microwell Plate Accessories	5	45650.00
CLSTTLO-1000	Tough-Tags 1.28 x 0.50" Orange	Labels	5	26757.50	CLSWRIT-1000	Write Protect, 1.25 x 0.50"	Tape	5	22825.00
CLSTTLR-1000	Tough-Tags 1.28 x 0.50" Red	Labels	5	26757.50	CLSWRIT-2000	Write Protect, 1.60 x 0.63"	Tape	5	22825.00
CLSTTLW-1000	Tough-Tags 1.28 x 0.50" 1,000/roll	Labels	5	19250.00	CLSWSDR-1000	Wash-N-Dry Cover Slip Rack	Microscopy	5	24090.00
CLSTTLW-2016	Laser Tough-Tags 1.28 x 0.50" 2,125/pk	Labels	5	50160.00	CLSWSDR-2000	Wash-N-Dry Cover Slide Rack	Microscopy	5	35200.00
CLSTTLW-2016-B	Laser Tough-Tags 1.28 x 0.50" 2,125/pk, Blue	Labels	5	50160.00	CLSWSDR-BKER	200ml Tall Form Beacker	Microscopy	5	14080.00
CLSTTLW-2016-G	Laser Tough-Tags 1.28 x 0.50" 2,125/pk, Green	Labels	5	50160.00	CLSXYLN-1000	.875" x .875" Xylene Resistant Labels	Labels	5	56980.00
CLSTTLW-2016-O	Laser Tough-Tags 1.28 x 0.50" 2,125/pk, Orange	Labels	5	50160.00	CLSXYLN-2000	1.69" x .625" Xylene Resistant Labels	Labels	5	56980.00
CLSTTLW-2016-R	Laser Tough-Tags 1.28 x 0.50" 2,125/pk, Red	Labels	5	50160.00					

Microscope slides

- Produced from the finest quality optical white glass
- Better optical properties than most microscope slides
- Packed in high quality plastic boxes
- Dimensions: 25 x 75mm (+/- 0.5mm)
- Thickness: 1mm (+/- 0.05mm)



Cat No	Product	Pack Size	Price
CLS1380-10	Microscope slides, ground edges, 90 corners, plain	1440	28200.00
CLS1380-20	Microscope slides, ground edges, 90 corners, frosted	1440	28200.00
CLS1380-30	Microscope slides, ground edges, 90 corners, frosted 1 end, 2 sides	1440	28200.00

CLS1380-50	Microscope slides, ground edges, 90 corners, frosted aqua	1440	28200.00
------------	---	------	----------

Available Color: Aqua, Blue, Gold, Green, Lilac, Orange, Pink, Tan, White, Yellow

CLS1384-50W	Microscope slides, 45 beveled edges, clipped corners	1440	28200.00
-------------	--	------	----------

CLS1365-10W	Microscope slides for use on automated instruments, ground edges, clipped corners	1440	28200.00
-------------	---	------	----------

Available Color: White

CLS1358A	Charged microscope slides, ground edges, 90 corners	1440	63582.00
----------	---	------	----------

Available Color: Aqua, Blue, Green, Lilac, Orange, Pink, Tan, White, Yellow

CLS1354P	Charged microscope slides, 45 beveled edges, frosted white	1440	41064.00
----------	--	------	----------

Available Color: Frosted Pink, Frosted White, Frosted Yellow

Plain Microscope slides

- Dimensions: 25 x 75 x 1mm
- Thickness: 1 - 1.2mm
- Packaging: 72/box, 20 boxes/case (10 gross)



Cat No	Product	Pack Size	Price
CLS1301	Plain, ground edges, 90 corners	1440	16194.00
CLS1321	Plain, ground edges, safety corners	1440	16194.00
CLS1331	Plain, beveled edges with clipped corners	1440	21450.00

Frosted Microscope Slides

- Dimensions: 25 x 75 x 1mm
- Thickness: 1 - 1.2mm
- Packaging: 72/box, 20 boxes/case (10 gross)



Cat No	Product	Pack Size	Price
CLS1304	Frosted 1 end, 1 side, ground edges, 90 corners	1440	18681.00
CLS1308	Frosted 1 end, 2 sides, ground edges, 90 corners	1440	19841.00
CLS1324	Frosted 1 end, 1 side, ground edges with safety corners	1440	18682.00
CLS1328	Frosted 1 end, 2 sides, ground edges with safety corners	1440	19842.00
CLS1334	Frosted 1 end, 1 side, beveled edges with clipped corners	1440	23986.00
CLS1338	Frosted 1 end, 2 sides, beveled edges with clipped corners	1440	25147.00

Frosted Color

- Dimensions: 25 x 75 x 1mm
- Thickness: 1 - 1.2mm
- Frosted one end, one side Packaging: 72/box, 20 boxes/case (10 gross)



Ground Edge with 90 Corners

Cat No	Product	Pack Size	Price
CLS1304W	Frosted, ground edge, 90 corners	1440	18622.00

Available Color: White, Blue Green, Orange, Pink, Tan, Yellow

Ground Edge with Safety Corners

Cat No	Product	Pack Size	Price
1324W	Frosted, ground edge with safety corners	1440	18622.00

Available Color: White, Aqua, Blue, Gold, Green, Lilac, Orange, Pink, Yellow

Beveled Edge with Clipped Corners

Cat No	Product	Pack Size	Price
CLS1334W	Frosted, beveled edge with clipped corners	1440	23290.00

Available Color: White, Blue Green, Pink, Yellow

Charged Microscope Slides

- Dimensions: 25 x 75 x 1mm
- Thickness: 1 - 1.2mm
- Frosted one end, one side Packaging: 72/box, 20 boxes/case (10 gross)



Ground Edge

Cat No	Product	Pack Size	Price
CLS1358	Charged microscope slide, Aqua	1440	63583.00

Available Color: Aqua, Blue, Green, Lilac, Orange, Pink, Tan, White, Yellow

Beveled Edge with Clipped Corners

CLS1354P	Charged microscope slide, beveled	1440	41064.00
----------	-----------------------------------	------	----------

Available Color: Pink, White, Yellow

Microscope Slides with Cavity

Our 25 x 75 x 1mm cavity microscope slides are pre-cleaned and ready to use. Two styles are available: single cavity or double cavity.



Cat No	Product	Pack Size	Price
CLS1341	Microscope slide with single cavity 72/box, 20 boxes/case	1440	71839.00
CLS1341-72	Microscope slide with single cavity	72	5569.00
CLS1344	Microscope slide with double cavity 72/box, 20 boxes/case	1440	140000.00
CLS1344-72	Microscope slide with double cavity	72	11502.00

Cover Glass

Our cover glass is packaged: 1 oz per box, 10 boxes per carton (10 oz). Each lip top box contains a desiccant and is vacuum sealed in aluminum to prevent sticking.



Cat No	Product	Unit	Pack Size	Price
CLS1401-10	18 x 18mm, No. 1	10 oz	248	4664.00
CLS1401-20	18 x 18mm, No. 2	10 oz	168	4664.00
CLS1402-10	20 x 20mm, No. 1	10 oz	192	4664.00
CLS1402-20	20 x 20mm, No. 2	10 oz	154	4664.00
CLS1404-10	22 x 22mm, No. 1	10 oz	168	4664.00
CLS1404-15	22 x 22mm, No. 1.5	10 oz	148	4664.00
CLS1404-20	22 x 22mm, No. 2	10 oz	136	4664.00
CLS1407-10	22 x 32mm, No. 1	10 oz	114	4664.00
CLS1407-20	22 x 32mm, No. 2	10 oz	84	4664.00
CLS1411-10	22 x 40mm, No. 1	10 oz	86	4664.00
CLS1411-20	22 x 40mm, No. 2	10 oz	75	4664.00
CLS1414-10	22 x 50mm, No. 1	10 oz	70	4664.00
CLS1414-20	22 x 50mm, No. 2	10 oz	63	4664.00
CLS1418-10	22 x 60mm, No. 1	10 oz	60	4664.00
CLS1418-20	22 x 60mm, No. 2	10 oz	50	4664.00
CLS1405-10	24 x 24mm, No. 1	10 oz	141	4664.00
CLS1405-20	24 x 24mm, No. 2	10 oz	102	4664.00
CLS1408-10	24 x 32mm, No. 1	10 oz	104	4664.00
CLS1408-20	24 x 32mm, No. 2	10 oz	78	4664.00
CLS1412-10	24 x 40mm, No. 1	10 oz	82	4664.00
CLS1412-20	24 x 40mm, No. 2	10 oz	71	4664.00
CLS1415-10	24 x 50mm, No. 1	10 oz	65	4664.00
CLS1415-15	24 x 50mm, No. 1.5	10 oz	56	4664.00
CLS1415-20	24 x 50mm, No. 2	10 oz	56	4664.00
CLS1419-10	24 x 60mm, No. 1	10 oz	55	4664.00
CLS1419-20	24 x 60mm, No. 2	10 oz	46	4664.00

Multi-Well Plates

96-Well Multi-Well Plates, Non-Treated

- Individually wrapped to protect from air contaminants.
- Available in "U", "V" and Flat bottoms

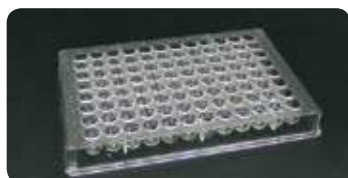

Round Bottom (U)
Each well is 300uL

Conical Bottom (V)
Each well is 250uL

Flat Bottom (-)
Each Well is 375uL

Cat No	Product	Pack Size	Price
CLS120030	U-bottom, individually wrapped, non-Sterile	50	12066.00
CLS120038	U-bottom, individually wrapped, Sterile	50	13108.00
120130	V-bottom, individually wrapped, non-Steri	50	12066.00
120138	V-bottom, individually wrapped, Sterile	50	13872.00
120330	Flat-bottom, individually wrapped, non-Sterile	50	12835.00
120338	Flat-bottom, individually wrapped, Sterile	50	13872.00
129930	Lid, individually wrapped, non-Sterile	150	21680.00
129938	Lid, individually wrapped, Sterile	150	25129.00

Sealing Film

Designed for the sealing of multi-well plates, our adhesive sealing films minimize evaporation, prevent spillage and eliminate well-to-well contamination.

The secure sealing of all wells eliminates "edge effects" in sensitive ELISA assays. Additionally, our films can be used to seal tissue culture plates for short term storage, incubation, transport, and the containment of biohazardous



Cat No	Product	Pack Size	Price
CLS129940	EZ-Seal sealing ilm, non-sterile	100	POR
CLS129948	EZ-Seal sealing ilm, STERILE	100	POR

Pipette Tips

Standard



Cat No	Product	Pack Size	Price
0.1 - 10uL			
CLS151154	For Pipetman P2-P10, natural, 31mm, 1000/ pack	1000	4231.00
CLS151154R-96	For Pipetman P2-P10, natural, 31mm, 96/rack, 10 racks per case	960	8872.00
CLS151154RS-96	For Pipetman P2-P10, natural, 31mm, 96/rack, 10 racks per case, STERILE	960	11011.00
0.5 - 20uL			
CLS151145	Ultra-micro tip, natural, 45mm, 1000/pack	1000	4322.00
CLS151145R-96	Ultra-micro tip, natural, 45mm, 96/rack, 10 racks per case	960	9213.00
CLS151145RS-96	Ultra-micro tip, natural, 45mm, 96/rack, 10 racks per case, STERILE	960	13377.00
1-200uL			
CLS152143	Universal, yellow, 1000/pack	1000	2730.00
CLS152143R	Universal, yellow, 200/rack, 5 racks/stack	1000	5510.00
CLS151140	For use with MLA & Ovation, natural, 1000/pack	1000	2984.00
CLS151140R	For use with MLA & Ovation, natural, 200/rack, 5 racks/stack	1000	5514.00
CLS151143	For use with Eppendorf, yellow, 1000/pack	1000	2984.00
CLS151241	For use with Oxford 8000 series, natural, 1000/pack	1000	3767.00
CLS151241R	For use with Oxford 8000 series, natural, 200/ rack, 5 racks/stack	1000	12285.00
CLS151142	For use with Oxford SlimLine, natural, 1000/pack	1000	2691.00
CSL10-500uL			
CLS151351	For use with Beckman & Oxford Lancer, natural, 70mm, 1000/pack	1000	6433.00
200-500uL			
CLS151242	For Oxford 8000 series, yellow, 1000/pack	1000	8340.00

Cat No	Product	Pack Size	Price
100-1000uL			
C151146	Universal, blue, 1000/pack	1000	3380.00
C151146R	Universal, blue, 200/rack, 5 racks/stack	1000	6137.00
C151341	For use with Selectapette, natural, 1000/pack	1000	10801.00
200-1000uL			
C151147	For use with MLA pipettors, natural, 1000/pack	1000	5369.00
C151147R	For use with MLA pipettors, natural, 200/rack, 5 racks/stack (1000/rack)	1000	9750.00
C151243	For use with Oxford 8000 series, green, 1000/pack	1000	9100.00
C151144	For use with Oxford Benchmate, Oxford Slimline, Finnpiquette, Labsystems, blue, 1000/pack	1000	3735.00
1000-5000uL (1mL - 5mL)			
C151244	For use with MLA, Oxford, & Pipetman, natural, 116mm, 250/pack	250	3735.00
C151246	For Finnpiquette, Brand, Labsystems, SMI & EDP2, 250/pack	250	9330.00
C151247	For Biohit Proline, Oxford & Eppendorf Research, natural, 250/pack	250	7725.00
1000-10,000uL (1mL - 10mL)			
C151249	For use with Pipetman P10, natural, 250/pack	250	5992.00
C151250	For use with Finnpiquette, Brand, Gilson & Socorex, 100/bag	100	7816.00
C151247	For Biohit Proline, Oxford & Eppendorf Research, natural, 250/pack	250	7725.00

Cat No	Product	Pack Size	Price
C151151RS-96	Universal, graduated, natural, 58mm, 96/rack, 10 racks/case, STERILE	1000	12239.00
(Graduated at 10uL, 20uL, 50uL, 100uL and 200uL)			
100 - 1000uL			
C151152	Universal, graduated, natural, 70mm, 1000/pack	1000	5778.00
C151152R	Universal, graduated, natural, 70mm, 200/rack, 5 racks/stack	1000	8872.00
C151152R-100	Universal, graduated, natural, 70mm, 100/rack, 10 racks/case	1000	11306.00
C151152RS-100	Universal, graduated, natural, 70mm, 100/rack, 10 racks/case, STERILE	1000	16516.00
C151152B	Universal, graduated, blue, 70mm, 1000/pack	1000	5778.00
C151152BR	Universal, graduated, blue, 70mm, 200/rack, 5 racks/stack	1000	8872.00
C151152BR-100	Universal, graduated, blue, 70mm, 100/rack, 10 racks/case	1000	11306.00
C151152BRS-100	Universal, graduated, blue, 70mm, 100/rack, 10 racks/case, STERILE	1000	16516.00
(Graduated at 100uL, 250uL, 500uL, 750 and 1000uL)			
100 - 1250uL			
C151153	Universal, graduated, natural, 84mm (extra long), 1000/pack	1000	5687.00
C151153R-100	Universal, graduated, natural, 84mm (extra long), 100/rack, 10 racks/case	1000	13832.00
(Graduated at 100uL, 250uL, 500uL, 750 and 1000uL)			

Reference (Graduated)

- Low retention
- Universal fit - designed for use on all popular pipettors
- Pipette tips are fully autoclavable (121°C/15 minutes)



Cat No	Product	Pack Size	Price
1 - 200uL			
C151150	Universal, graduated, natural, 50mm, 1000/pack	1000	4982.00
C151150R	Universal, graduated, natural, 50mm, 200/rack, 5 racks/stack	1000	7621.00
C151150R-96	Universal, graduated, natural, 50mm, 96/rack, 10 racks/case	1000	9395.00
C151150RS-96	Universal, graduated, natural, 50mm, 96/rack, 10 racks/case, STERILE	1000	10692.00
C151150Y	Universal, graduated, yellow, 50mm, 1000/pack	1000	4982.00
C151150YR	Universal, graduated, yellow, 50mm, 200/rack, 5 racks/stack	1000	7621.00
C151150YR-96	Universal, graduated, yellow, 50mm, 96/rack, 10 racks/case	1000	9395.00
C151150YRS-96	Universal, graduated, yellow, 50mm, 96/rack, 10 racks/case, STERILE	1000	20692.00
(Graduated at 10uL, 20uL, 50uL, 100uL and 200uL)			
1 - 300uL			
C151151	Universal, graduated, natural, 58mm, 1000/pack	1000	5551.00
C151151R	Universal, graduated, natural, 58mm, 200/rack, 5 racks/stack	1000	7962.00
C151151R-96	Universal, graduated, natural, 58mm, 96/rack, 10 racks/case	1000	11488.00

Filter Tips (Sterile)

Globe Scientific's line of filter pipette tips are designed for accuracy and aerosol protection. They are universal and fit most popular brands of pipettors.



All filter tips are sterile and packaged in lip-top boxes. The heavy duty box is produced from polypropylene and can be autoclaved for repeated use.

- Sterile
- Rnase, DNase and Pyrogen Free
- Universal Fit - designed for use on all popular pipettors
- Pipette tips are not autoclavable

Pipette Tips: Polypropylene (PP) Filter: Polyethylene (PE)

Cat No	Size	Length	Graduations	Unit	Price
C153800	0.1-10uL	31mm	Non-graduated	96 x 10 Rack	26208.00
C153805	0.5-10uL	45mm	Non-graduated	96 x 10 Rack	24570.00
C153810	1-20uL	50mm	10, 20, 50, 100 & 200uL	96 x 10 Rack	24570.00
C153815	1-100uL	50mm	10, 20, 50, 100 & 200uL	96 x 10 Rack	24570.00
C153820	1-200uL	50mm	10, 20, 50, 100 & 200uL	96 x 10 Rack	24570.00
C153825	1-250uL	58mm	10, 20, 50, 100 & 200uL	96 x 10 Rack	24570.00
C153830	1-1000uL	70mm	100, 250, 500, 750 & 1000uL	100 x 10 Rack	27927.00
C153835	1-1000uL	86mm	100, 250, 500, 750 & 1000uL	100 x 10 Rack	27927.00

Wide Mouth Bottles

Wide Mouth, Square Bottles (Rigid), LDPE
Bottle = Low Density Polyethylene (LDPE),
Cap = Polypropylene (PP)

- Graduated
- Dual-cap feature. Each bottle includes a screw cap and a plug insert, providing a completely leak-resistant seal.
- Tagging points for use with optional wire security ties
- Food grade



Cat No	Product	Pack Size	Price
C600608	25mL (0.8oz) wide mouth, square, LDPE	100/case	29484.00
C600609	50mL (1.5 oz) wide mouth, square, LDPE	100/case	33196.00
C600610	100mL (3 oz) wide mouth, square, LDPE	100/case	43734.00
C600611	250mL (8 oz) wide mouth, square, LDPE	50/case	25825.00
C600612	500mL (16 oz) wide mouth, square, LDPE	25/case	17226.00
C600613	1000mL (32 oz) wide mouth, square, LDPE	20/case	22577.00
C600614	2000mL (64 oz) wide mouth, square, LDPE	20/case	41796.00

Wide Mouth Bottles

Wide Mouth, Round Bottles (Extra Flexible), LDPE
Bottle = Low Density Polyethylene (LDPE),
Cap = Polypropylene (PP)

- Graduated
- Dual-cap feature. Each bottle includes a screw cap and a plug insert, providing a completely leak-resistant seal.
- Tagging points for use with optional wire security ties
- Food grade



Cat No	Product	Pack Size	Price
C600408	50mL (1.5 oz) wide mouth, LDPE	100/case	28746.00
C600409	100mL (3 oz) wide mouth, LDPE	100/case	30739.00
C600410	250mL (8 oz) wide mouth, LDPE	50/case	20447.00
C600411	500mL (16 oz) wide mouth, LDPE	20/case	10346.00
C600412	1000mL (32 oz) wide mouth, LDPE	20/case	17007.00
C600413	2000mL (64 oz) wide mouth, LDPE	20/case	36882.00

Wide Mouth Bottles

Wide Mouth, Round Bottles (Flexible),
LDPE

Bottle = Low Density Polyethylene (LDPE),
Cap = Polypropylene (PP)

- Graduated
- Deep threaded neck for excellent leak-resistance
- Food Grade



Cat No	Product	Pack Size	Price
C601608	50mL (1.5 oz) wide mouth, LDPE	100/case	40950.00
C601610	100mL (3 oz) wide mouth, LDPE,	100/case	52361.00
C601612	250mL (8 oz) wide mouth, LDPE	50/case	37237.00
C601614	500mL (16 oz) wide mouth, LDPE	25/case	22113.00
C601616	1000mL (32 oz) wide mouth, LDPE	17/case	29265.00
C601618	2000mL (64 oz) wide mouth, LDPE	15/case	38247.00

Wide Mouth Bottles

Wide Mouth, Round Bottles (Rigid), PP
Bottle and Cap = Polypropylene (PP)

- Completely rigid and rupture-resistant
- Graduated
- Deep threaded neck for excellent leak-resistance
- Food grade
- Autoclavable at 121°C. Do not autoclave with caps on.



Cat No	Product	Pack Size	Price
C601621	50mL (1.5 oz) wide mouth, PP	100/case	46628.00
C601623	100mL (3 oz) wide mouth, PP	100/case	57603.00
C601625	250mL (8 oz) wide mouth, PP	50/case	39039.00
C601627	500mL (16 oz) wide mouth, PP	25/case	25252.00
C601629	1000mL (32 oz) wide mouth, PP	17/case	29647.00
C601631	2000mL (64 oz) wide mouth, PP	15/case	44034.00

Narrow Mouth Bottles

Narrow Mouth, Round Bottles (Rigid), PP
Bottle and Cap = Polypropylene (PP)

- Completely rigid and rupture-resistant
- Graduated
- Tagging points for use with optional wire security ties
- Food grade
- Autoclavable at 121°C. Do not autoclave with caps on



Cat No	Product	Pack Size	Price
C601595	50mL (1.5 oz) narrow mouth, PP	100/case	34206.00
C601597	100mL (3 oz) narrow mouth, PP	100/case	41059.00
C601599	250mL (8 oz) narrow mouth, PP	50/case	3558.00
C601601	500mL (16 oz) narrow mouth, PP	25/case	18181.00
C601603	1000mL (32 oz) narrow mouth, PP	20/case	25771.00

Narrow Mouth Bottles

Narrow Mouth, Round Bottles (Flexible), LDPE
Bottle = Low Density Polyethylene (LDPE),
Cap = Polypropylene (PP)

- Graduated
- Dual-cap feature. Each bottle includes a screw cap and a plug insert, providing a completely leak-resistant seal
- Tagging points for use with optional wire security ties
- Food grade



Cat No	Product	Pack Size	Price
C60031	50mL (1.5oz) narrow mouth, LDPE	100/case	30849.00
C600319	100mL (3 oz) narrow mouth, LDPE	100/case	31449.00
C600323	250mL (8 oz) narrow mouth, LDPE	50/case	22604.00
C600324	500mL (16 oz) narrow mouth, LDPE	25/case	17144.00
C600325	1000mL (32 oz) narrow mouth, LDPE	20/case	20884.00
C600326	2000mL (64 oz) narrow mouth, LDPE	20/case	42369.00

Wash Bottles

Wash Bottle with Integrated Spout, LDPE

Bottle = Low Density Polyethylene (LDPE),
Cap = Polypropylene (PP)

- Easy grip, stable shape
- Dispensing tube with closure cap
- Dual-cap feature. Each wash bottle includes a screw cap and a plug insert, providing a completely leak-resistant seal.
- Tagging points for use with optional wire security ties
- Food grade



Cat No	Product	Pack Size	Price
C601633	250mL (8 oz) wash bottle, LDPE	100/case	8872.00
C601634	500mL (16 oz) wash bottle, LDPE	10/case	10756.00

Centrifuge Tubes

12 mL Flared-Top Urine Centrifuge Tubes

This line of centrifuge tubes has been designed specifically for urinalysis procedures. The tubes offer a flared-opening which is designed to make pouring of easy.

- Dimensions: 20 x 115mm
- Polystyrene (PS): 1500 RCF



Cat No	Product	Pack Size	Price
C112017	12mL polystyrene (PS), graduated, conical bottom, Ames-Type	1500	26567.00
C112015	12mL polystyrene (PS), graduated, round bottom, Kova-Type	2000	30272.00
C112030	12mL polystyrene (PS) with sediment bulb, graduated, Whale-Type	1500	24383.00

12 mL Centrifuge Tubes

- Dimensions: 16 x 100mm
- Graduated at 0.5, 1, 2.5, 5 and 10mL
- Polystyrene (PS): 1500 RCF
- Polypropylene (PP): 3000 RCF



Cat No	Product	Pack Size	Price
C112010	12mL (16 x100mm), conical bottom, graduated, polystyrene (PS)	2000	31354.00
C112010-500	12mL (16 x100mm), conical bottom, graduated, polystyrene (PS)	500	8130.00
C112040	12mL (16 x100mm), conical bottom, graduated, polypropylene (PP)	2000	26667.00
C112040-500	12mL (16 x100mm), conical bottom, graduated, polypropylene (PP)	500	7775.00
C112009	12mL (16 x100mm), conical bottom, polystyrene (PS) w/ separate plug cap	1000	21061.00

10 mL Centrifuge Tubes

- Dimensions: 16 x 100mm
- Printed graduations
- Spin Rate: 3000 RCF
- Tube and Cap: Polypropylene (PP)



Cat No	Product	Pack Size	Price
C6292	10mL (16 x100mm), with separate natural screw cap, 500/bg, 2 bags/cs	1000	28137.00
C6293	10mL (16 x100mm), with attached yellow screw cap, STERILE, 100/bag, 10 bags/case	1000	28878.00

15mL Centrifuge Tubes

- Dimensions: 16.6 x 120mm
- Graduated from 0.5mL to 15mL in 0.5mL increments
- Polystyrene (PS): 1500 RCF
- Polypropylene (PP): 3000 RCF



Cat No	Product	Pack Size	Price
C6260	15mL polystyrene (PS), 250/pack, 4 packs/case	1000	12762.00
C6260-250	15mL polystyrene (PS), 250/pack	250	4586.00
C6265	15mL polystyrene (PS), 100/dispenser box, 10 boxes/case	1000	14414.00
C6261	15mL polypropylene (PP), 250/pack, 4 packs/case	1000	12244.00
C6266	15mL polypropylene (PP), 100/dispenser box, 10 boxes/case	1000	14004.00
C6262	15mL polystyrene (PS), with separate plug cap	1000	17654.00
C6263	Plug cap for 15mL tubes	1000	4868.00

Stainless Steel Racks

These specially shaped "Z" racks are rust proof and will hold up to repeated use. The wide base provides stability and prevents tipping. When not in use, the racks

stack neatly inside one another to conserve benchtop space

- Autoclavable

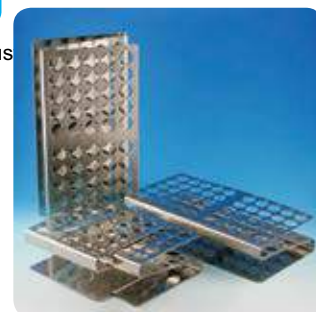

Cat No	Product	Pack Size	Price
C457100	For 12 & 13mm tubes, 4 x 4 x 1.75", 25-place	Each	3021.00
C457105	For 12 & 13mm tubes, 8 x 4 x 2", 50-place	Each	4067.00
C457200	For 15, 16 & 17mm tubes, 4.5 x 4.25 x 1.5", 25-place	Each	3021.00
C457205	For 15, 16 & 17mm tubes, 8.75 x 4.5 x 2", 50-place	Each	4172.00

15 mL Centrifuge Tubes

- 15 mL Centrifuge Tubes
- Dimensions: 17 x 120mm
 - Cap is made from High Density Polyethylene (HDPE)
 - Sterile tubes are RNase/Dnase and Pyrogen free.
 - White graduations and writing area.

Spin Rate:

Polystyrene (PS) - 1700 RCF (3000 x g)

Acrylic (AC) - 5000 RCF (6,160 x g)

Polypropylene (PP) - 10,000 RCF (12,320 x g)



Cat No	Product	Pack Size	Price
C6268	15mL polystyrene (PS) centrifuge tube, non-sterile, with separate screwcap, bulk	500	22463.00
C6272	15mL polystyrene (PS) centrifuge tube, STERILE, 25/bag, 500/case	500	27389.00
C6274	15mL polystyrene (PS) centrifuge tube, STERILE, 50/rack, 500/case	500	34516.00
C6267	15mL acrylic (AC) centrifuge tube, non-sterile, with separate screwcap, bulk	500	27418.00
C6270	15mL acrylic (AC) centrifuge tube, STERILE, 25/bag, 500/case	500	28924.00
C6273	15mL acrylic (AC) centrifuge tube, STERILE, 50/rack, 500/case	500	26554.00
C6264	15mL polypropylene (PP) centrifuge tube, non-sterile, with separate screwcap, bulk	500	22463.00
C6269	15mL polypropylene (PP) centrifuge tube, STERILE, 25/bag, 500/case	500	25389.00
C6271	15mL polypropylene (PP) centrifuge tube, STERILE, 50/rack, 500/case	500	32305.00

50 mL Self-Standing Polypropylene - Printed Graduations

- Dimensions: 30 x 115 mm
- Cap is made from High Density Polyethylene (HDPE)
- Sterile tubes are RNase/Dnase and Pyrogen free
- White graduations and writing area
- Autoclavable (without screwcap)



Cat No	Product	Pack Size	Price
C255	50mL, non-sterile, bulk	500	25994.00
C256	50mL, STERILE, 25/bag, 500/case	500	31545.00
C255MF	50mL, metal free, neutral cap, non-sterile	500	25994.00

Microcentrifuge Tubes



50 mL Centrifuge Tubes

- 50 mL Centrifuge Tubes
- Dimensions: 29.5 x 114mm
 - Cap is made from High Density Polyethylene (HDPE)
 - Sterile tubes are RNase/Dnase and Pyrogen free
 - White graduations and writing area
 - Polypropylene tubes are autoclavable (without screwcap)

Spin Rate:

Polystyrene (PS) - 1700 RCF (3000 x g)

Acrylic (AC) - 5000 RCF (6,160 x g)

Polypropylene (PP) - 10,000 RCF (12,320 x g)



Cat No	Product	Pack Size	Price
C6240	50mL polypropylene (PP) centrifuge tube, non-sterile, 25/bag, 500/case	500	28319.00
C6241	50mL polypropylene (PP) centrifuge tube, STERILE, 25/bag, 500/case	500	32182.00
C6242	50mL polypropylene (PP) centrifuge tube, non-sterile, 25/rack, 500/case	500	42315.00
C6243	50mL polypropylene (PP) centrifuge tube, STERILE, 25/rack, 500/case	500	49126.00
C6244	50mL polypropylene (PP) centrifuge tube, non-sterile, with separate screwcap, bulk	500	26521.00
C6253	50mL polystyrene (PS) centrifuge tube, non-sterile, with separate screwcap, bulk	500	28146.00
C6254	50mL polystyrene (PS) centrifuge tube, STERILE, 25/bag, 500/case	500	35485.00
C6254R	50mL polystyrene (PS) centrifuge tube, STERILE, 25/rack, 500/case	500	52188.00

Non-Graduated, Attached Cap

Cat No	Product	Pack Size	Max. RPM	Price
C10540	500uL (0.5mL) polyethylene, non-autoclavable	1000	12000	6383.00

Graduated, Attached Cap

C10550	500uL (0.5mL), Eppendorf Type, polypropylene	1000	18000	8800.00
C11550	600uL (0.6mL), polypropylene	1000	30000	9113.00
C11558	1.5mL, polypropylene	1000	26000	3894.00
C11558B	1.5mL, polypropylene, blue	1000	18000	3894.00
C11558P	1.5mL, polypropylene, pink	1000	18000	3894.00
C11558Y	1.5mL, polypropylene, yellow	1000	18000	3949.00
C11553A	1.5mL, polypropylene, AMBER	1000	18000	10769.00
C11568	2mL, polypropylene, round bottom, 1000/pack	1000	18000	4627.00
C11552	2mL, polypropylene, 500/pack, 2 packs/box	1000	18000	10528.00
C11552A	2mL, polypropylene, AMBER, 500/pack, 10 packs/case	5000	18000	50600.00

Screw Cap Microcentrifuge Tubes

Tube = Polypropylene

- Cap = Polypropylene
- O-Ring = Nitrile

Centrifuge Maximum RCF = 18,000 RCF



Conical Bottom

Cat No	Product	Pack Size	Price
C11690	0.5mL tube with o-ring cap, STERILE	1000	42137.00
C11692	0.5mL tube only, non-sterile	1000	9400.00
C11710	1.5mL tube with o-ring cap, STERILE	1000	44089.00
C11712	1.5mL tube only, non-sterile	1000	10751.00
C11730	2.0mL tube with o-ring cap, STERILE	1000	44435.00
C11732	2.0mL tube only, non-sterile	1000	11070.00

Self Standing

Cat No	Product	Pack Size	Price
C11700	0.5mL tube with o-ring cap, STERILE	1000	40053.00
C11702	0.5mL tube only, non-sterile	1000	7152.00
C11720	1.5mL tube with o-ring cap, STERILE	1000	40781.00
C11722	1.5mL tube only, non-sterile	1000	7730.00
C11740	2.0mL tube with o-ring cap, STERILE	1000	44876.00
C11742	2.0mL tube only, non-sterile	1000	11274.00

Cryogenic Vials

CryoClear™ - Internal & External Threads

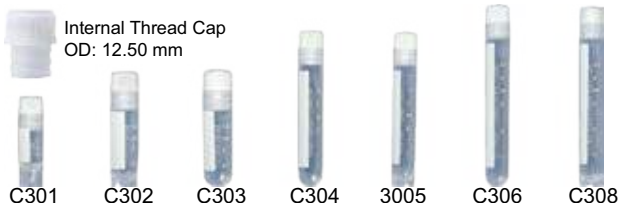

Internal Thread Cap
OD: 12.50 mm

Cat No	Volume	Dimensions (L x W)	Style	Bottom	Unit	Price
C301	1 mL	42.7 mm x 12.5 mm	Self Standing	Conical	500	33200.00
C302	2 mL	48.0 mm x 12.5 mm	Self Standing	Round	500	33200.00
C303	2 mL	47.0 mm x 12.5 mm	--	Round	500	33200.00
C304	3 mL	75.1 mm x 12.5 mm	--	Round	500	33200.00
C305	4 mL	76.1 mm x 12.5 mm	Self Standing	Round	500	33200.00
C306	5 mL	89.3 mm x 12.5 mm	--	Round	500	33200.00
C308	5 mL	90.4 mm x 12.5 mm	Self Standing	Round	500	33200.00



External Thread Cap
OD: 14.30 mm

Cat No	Volume	Dimensions (L x W)	Style	Bottom	Unit	Price
3001	1 mL	42.7 mm x 12.5 mm	Self Standing	Conical	500	33200.00
3002	2 mL	48.0 mm x 12.5 mm	Self Standing	Round	500	33200.00
3003	2 mL	47.0 mm x 12.5 mm	-	Round	500	33200.00
3004	3 mL	75.1 mm x 12.5 mm	-	Round	500	33200.00
3005	4 mL	76.1 mm x 12.5 mm	Self Standing	Round	500	33200.00
3006	5 mL	89.3 mm x 12.5 mm	-	Round	500	33200.00
3008	5 mL	90.4 mm x 12.5 mm	Self Standing	Round	500	33200.00

Workstation Racks

- 40-Place (10 x 4 format)
- Produced from Polycarbonate (PC)
- Anti-slip rubber feet
- Autoclavable at 121°C, 15 psig (1 bar) for 20 minutes
- Temperature range: -196°C to +121°C
- Dimensions: 215 x 100 x 25mm

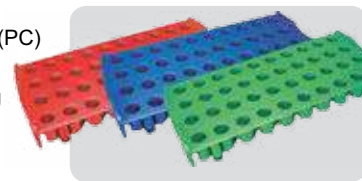

Cat No	Product	Pack Size	Price
C349	Workstation	5 Unit	19893.00

Available Color: Blue, Green, Red

BioBOX™ Storage Boxes with Transparent Lids

- Polycarbonate (PC)
- Temperature range: -196°C to +121°C
- Transparent lid for convenient viewing of contents
- The lid is printed with numbers for easy sample identification
- Lid has two angled corners to ensure the correct alignment of the well numbers
- Autoclavable at +121°C, 15 psig (1 bar) for 20 minutes
- Fits in stainless steel storage racks
- A plastic tube picker is supplied with each storage box



Cat No	Product	Pack Size	Price
C339	25-place for 1 & 2mL tubes	5	11465.00
C340	81-place for 1 & 2mL tubes	5	10198.00
C342	81-place for 3, 4 & 5mL external & 5mL internal	5	210297.00
C350	100-place for 1 & 2mL tubes	5	10551.00

Available Color: Blue, Green, Red, Yellow

Carboys

Store, mix and dispense bulk quantities of liquids, solvents & cleaning solutions. The carboys are available in four sizes and feature a standardized industrial packaging design. Not only can they be used in industrial packaging, but they are also useful in everyday laboratory practices. Produced from High Density Polyethylene (HDPE), they feature comfortable handles and secure seal caps.



Cat No	Product	Pack Size	Price
C61780	Carboys, 2 Liter (1/2 Gallon), HDPE	Each	3200.00
C61781	Carboys, 5 Liter (1.3 Gallon), HDPE	Each	5600.00
C61782	Carboys, 10 Liter (2.5 Gallon), HDPE	Each	8800.00
C61783	Carboys, 20 Liter (5 Gallon), HDPE	Each	16800.00
C61660	Carboys, with Spigot, Heavy Duty, 5 Liter (1.33 Gallon), HDPE, Spigot Included	1/Pack	15200.00
C61662	Carboys, with Spigot, Heavy Duty, 10 Liter (2.62 Gallon), HDPE, Spigot Included	1/Pack	20000.00
C61664	Carboys, with Spigot, Heavy Duty, 25 Liter (6.5 Gallon), HDPE, Spigot Included	1/Pack	38000.00
C61666	Carboys, with Spigot, Heavy Duty, 50 Liter (13 Gallon), HDPE, Spigot Included	1/Pack	62000.00

Serological Pipettes

One-Piece Plastic Serological Pipettes

Features:

- Smooth one-piece construction
- Calibration is certified for accuracy
- Aerosol barrier filter plug
- Ergonomic design for use in tight spaces
- Reverse graduations (except for 1mL & 2mL sizes)
- Negative graduations (not on the 25mL size)
- Fits all major brands of pipettors
- Safe alternative to glass pipettes
- Calibrated to deliver (TD). Meets ASTM E934

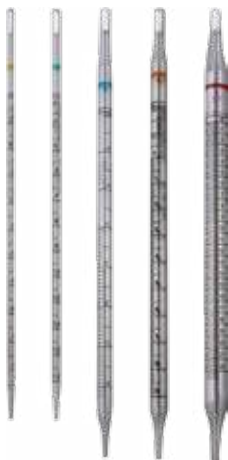

Technical Specifications

- Material: Polystyrene (PS)
- Plug: Bonded polyolefin fiber
- Inaccuracy: <2% at full volume
- Pyrogen-free, LAL tested (0.5Eu/mL), (AAMI ST72) and Alternatives to Batch Testing (2002/(R)2010), non-hemolytic (ISO 10993-4), non-cytotoxic (ISO 10993-5)
- Sterility: Sterilized by gamma irradiation
- RNase-free and DNase-free
- Sterility assurance level (SAL): 10⁻⁶
- Sizes: 1mL, 2mL, 5mL, 10mL and 25mL

Cat No	Product	Pack Size	Price
C700	1mL, individually wrapped, sterile	500	17390.00
C710	1mL, 25 per pack, sterile	1000	31827.00
C715	1mL, 25 per pack, non-sterile	1000	31617.00
C720	2mL, individually wrapped, sterile	500	18573.00
C730	2mL, 25 per pack, sterile	1000	35435.00
C735	2mL, 25 per pack, non-sterile	1000	31840.00
C740	5mL, individually wrapped, sterile	250	13167.00
C750	5mL, 25 per pack, sterile	375	18746.00
C755	5mL, 25 per pack, non-sterile	375	16493.00
C760	10mL, individually wrapped, sterile	200	11334.00
C770	10mL, 25 per pack, sterile	250	12881.00
C775	10mL, 25 per pack, non-sterile	250	11058.00
C780	25mL, individually wrapped, sterile	100	11739.00
C784	25mL, individually wrapped, non-sterile	100	9442.00
C380	Diamond SeroLogic™ portable pipette controller	1	56875.00

50mL Serological Pipettes

- Material: Polystyrene
- Fiber filter plug
- Non-pyrogenic
- Ascending and descending graduations
- Negative graduations for extra working volume
- Sterilized by gamma irradiation
- Sterility assurance level (SAL): 10⁻⁶
- Individually wrapped in thermoformed paper/plastic peel packaging
- Safe alternative to glass pipettes
- Calibrated to deliver (TD) at +/-2%. Meets ASTM E934



Cat No	Product	Pack Size	Price
C820	50mL serological pipette, sterile, individually wrapped	100	21157.00

Open-End Pipettes

- Material: Polystyrene (PS)
- Fiber filter plug
- Sterilized by gamma irradiation
- Sterility assurance level (SAL): 10⁻⁶
- Non-pyrogenic
- Individually wrapped in thermoformed paper/plastic peel packaging
- Safe alternative to glass pipettes
- Industry standard color coding meets ASTM E1380
- Calibrated to deliver (TD) at +/-2%. Meets ASTM E934



Cat No	Product	Pack Size	Price
C860	1mL open end pipette, sterile, individually wrapped	1000	POR
C864	2mL open end pipette, sterile, individually wrapped	800	POR
C868	5mL open end pipette, sterile, individually wrapped	300	POR
C872	10mL open end pipette, sterile, individually wrapped	200	POR

Bacteriological Pipettes

Designed for use in the dairy field, these sterile pipettes meet the A.P.H.A. standard for the examination of dairy products. They are available in 1.1mL and 2.2mL sizes.

- Material: Polystyrene (PS)
- Fiber filter plug
- Reverse graduations
- Negative graduations
- Sterilized by gamma irradiation
- Sterility assurance level (SAL): 10⁻⁶
- Non-pyrogenic
- Individually wrapped in thermoformed paper/plastic peel packaging
- Safe alternative to glass pipettes
- Calibrated to deliver (TD) at +/-2%. Meets ASTM E934



Cat No	Product	Pack Size	Price
C825	1.1mL bacteriological pipette, individually wrapped	1000	POR
C826	1.1mL bacteriological pipette, 25/pack	1000	POR
C828	2.2mL bacteriological pipette, individually wrapped	800	POR
C829	2.2mL bacteriological pipette, 25/pack	800	POR

Aspirating Pipettes

- Material: Polystyrene (PS)
- Transparent, no graduation marks
- Non-plugged
- Sterilized by gamma irradiation
- Sterility assurance level (SAL): 10⁻⁶
- Non-pyrogenic
- Individually wrapped in thermoformed paper/plastic peel packaging
- Safe alternative to glass pipettes



Cat No	Product	Pack Size	Price
C830	1mL aspirating pipette, sterile, individually wrapped	1000	35000.00
C834	2mL aspirating pipette, sterile, individually wrapped	800	31000.00
C838	5mL aspirating pipette, sterile, individually wrapped	300	16800.00
C842	10mL aspirating pipette, sterile, individually wrapped	200	13200.00
C846	25mL aspirating pipette, sterile, individually wrapped	200	23200.00
C850	50mL aspirating pipette, sterile, individually wrapped	100	19500.00

Large Capacity Rack

This line of plastic test tube racks are shipped flat in order to reduce shelf space and then simply snap together for use. The special design allows all samples to be incubated at the same temperature. These racks can be used in freezers without deforming or going brittle. They will not rot, rust or deform. Alphanumeric markings are molded into the racks to provide easy test tube identification. They are available in four colors for color coding test samples, or simply for aesthetics in the modern laboratory. They are stackable when empty.

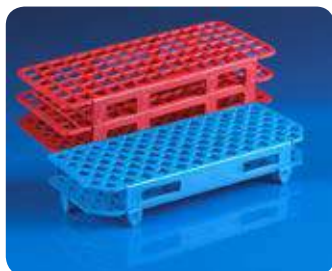

Easy to assemble

- Produced from polypropylene (PP)
- Autoclavable at 121°C for 20 minutes
- Non-loading in a water bath

For Microcentrifuge Tubes

100 holes, rack dimensions: 263 x 109 x 45mm

Cat No	Product	Pack Size	Price
C56303	Microcentrifuge Tube Rack	Each	2893.00

For 12 & 13mm Tubes

90 holes, 6 x 15 format, rack dimensions: 246 x 105 x 64mm

C56403	13mm size, 90-place	Each	1342.00
--------	---------------------	------	---------

For 16 & 17mm Tubes

60 holes, 5 x 12 format, rack dimensions: 246 x 105 x 72mm

C56503	16mm size, 60-place	Each	1342.00
--------	---------------------	------	---------

For 20 & 21mm Tubes

40 holes, 4 x 10 format, rack dimensions: 246 x 105 x 72mm

C56603	20mm size, 40-place	Each	1342.00
--------	---------------------	------	---------

For 25mm Tubes

40 holes, 4 x 10 format, rack dimensions: 295 x 125 x 85mm

C56703	25mm size, 40-place, white	Each	3831.00
--------	----------------------------	------	---------

For 30mm Tubes

24 holes, 3 x 8 format, rack dimensions: 300 x 112 x 85mm

C56803	30mm size, 24-place, white	Each	4122.00
--------	----------------------------	------	---------

Color Available: White, Blue, Red, Yellow

10 & 12 Place Racks

These traditional test tube holders are lightweight, compact and unbreakable. They take up less space on the benchtop to provide a larger work area. They are produced from durable polypropylene (PP) and can be autoclaved at 121°C for 20 minutes.



Cat No	Product	Pack Size	Price
C56105	For 12mm & 13mm tubes, 12-place, (2 x 6 configuration), white	Each	3239.00
C56106	For 16 to 18mm tubes, 10-place, (1 x 10 configuration), white	Each	2802.00

10-Place Polystyrene Rack

This rack has been designed for use with the Sedi-Rate™ and Sedigren™ ESR Systems as well as holding a variety of test tubes.



Cat No	Product	Pack Size	Price
C56105	10-place rack	Each	3500.00

Grip Racks

These specially designed test tube racks feature rubber grips that hold test

tubes in place when decanting liquid (see photo A). Item #C56925 & #C56926 feature a unique tube ejector that allows the user to easily eject all tubes into a waste receptacle (see photo B)

- 50-place (5 x 10 configuration)
- Single rack accommodates a variety of tube sizes
- Holds tubes securely while decanting



Grip Rack

For up to 17mm tubes. Dimensions: 254 x 140 x 51mm.

- Low profile rack allows for easy viewing of labels on tubes.

Cat No	Product	Pack Size	Price
C56920	Blue	Each	2052.00
C56921	Orange	Each	2052.00

Grip Rack with Tube Ejector

For up to 16mm tubes. Dimensions: 260 x 140 x 82mm.

Cat No	Product	Pack Size	Price
C56925	Blue	Each	3125.00
C56926	Orange	Each	3125.00

Centrifuge Tube Racks

Designed to hold both 15mL and 50mL centrifuge tubes in one rack! The rack ships flat and is simple to assemble. It holds twenty 50mL and thirty 15mL centrifuge tubes.

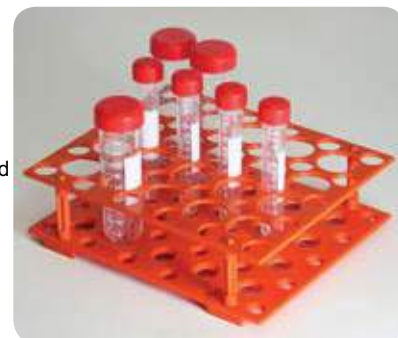

Cat No	Product	Pack Size	Price
C56930	For 15mL & 50mL centrifuge tubes, orange Dimensions: 209 x 171 x 63mm	Each	1500.00

10 bp DNA Ladder

Recommended Loading: 2-5 µl/Lane
 Concentration Typical Bands: 100 ng/5µl
 Concentration Other Bands: 40 ng/5µl
 Advised Electrophoresis Condition: 8 cm,
 5% Agarose Gel, 0.5×TBE, 5 V/cm, 1 h
 Contents bp: 80, 90, 100, 110, 120, 130,
 140, 150, 160, 170, 180, 190, 200, 210, 220,
 230, 240, 250, 260, 270, 280, 290,300
 Mix Concentration: 168 ng/µl
 Storage: -20°C



Cat No	Product	Size	Price
CLS014-10	10 bp DNA Ladder	500ul	8500.00
CLS014-10	10 bp DNA Ladder	5x500ul	40375.00

20 bp DNA Ladder

Recommended Loading: 2-5 µl/Lane
 Concentration Typical Bands 100 ng/5µl
 Concentration Other Bands: 40 ng/5µl
 Advised Electrophoresis Condition: 8 cm,
 5% Agarose Gel, 0.5×TBE, 5 V/cm, 1 h
 Contents bp: 60, 80, 100, 120, 140, 160,
 180, 200, 220
 240, 260, 280, 300
 Mix Concentration: 128 ng/µl
 Storage: -20°C



Cat No	Product	Size	Price
CLS014-20	20 bp DNA Ladder	500ul	8500.00
CLS014-20	20 bp DNA Ladder	5x500ul	40375.00

50 bp DNA Ladder

Range: 50-1,500 bp
 Number of bands: 17
 Concentration: 112 µg/ml
 Package: 56ug/500ul
 Recommended Load: 5 µl / well
 Storage: -20°C
 Containing orange G as tracking dyes.

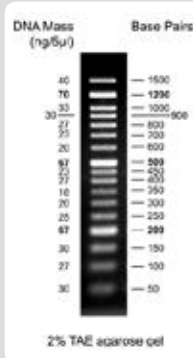

Cat No	Product	Size	Price
CLS012-R500	50 bp DNA Ladder	500ul	6270.00
CLS012-R500	50 bp DNA Ladder	5x500ul	29700.00

100 bp DNA Ladder

Range: 100-3,000 bp
 Number of bands: 12
 Concentration: 108 µg/ml
 Package: 54ug/500ul
 Recommended Load: 5 µl / well
 Storage: RT and 4°C up to 6 month.
 Store at -20°C up to 1 year.
 Containing orange G & xylene cyanol FF
 as tracking dyes.

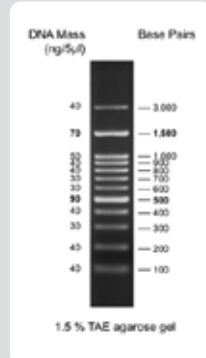

Cat No	Product	Size	Price
CLS001-R500	100 bp DNA Ladder	500ul	3420.00
CLS001-R500	100 bp DNA Ladder	5x500ul	16700.00

1Kb DNA Ladder

Range: 250-10,000 bp
 Number of bands: 13
 Concentration: 100 µg/ml
 Package: 50ug/500ul
 Recommended Load: 5 µl / well
 Containing bromophenol blue & xylene
 cyanol FF as tracking dyes.

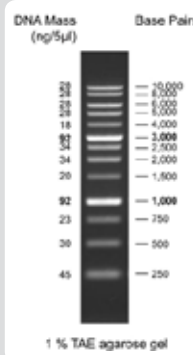

Cat No	Product	Size	Price
CLS010-R500	1Kb bp DNA Ladder	500ul	3420.00
CLS010-R500	1Kb bp DNA Ladder	5x500ul	16700.00

KPlus DNA Ladder

Range: 100-10K bp
 Number of bands: 19
 Concentration: 100 µg/ml
 Package: 86ug / 500ul
 Recommended Load: 5 µl well
 Containing orange G, xylene cyanol FF and
 bromophenol blue as tracking dyes.

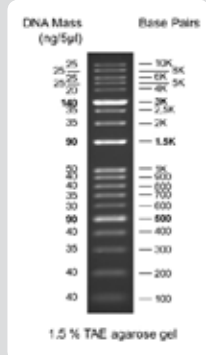

Cat No	Product	Size	Price
CLS011-R500	KPlus DNA Ladder	500ul	6270.00
CLS011-R500	KPlus DNA Ladder	5x500ul	30400.00



XLarge DNA Ladder

Range: 250-25K bp
 Number of bands: 14
 Concentration: 104 µg/ml
 Package: 52ug / 500ul
 Recommended Load: 5 µl well
 Storage: 25°C for 6 months,
 Store at 4°C for 12months,
 Store at -20°C for 24 months

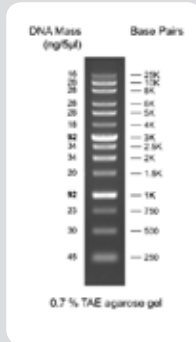

Cat No	Product	Size	Price
CLS013-R500	XLarge DNA Ladder	500ul	6270.00
CLS013-R500	XLarge DNA Ladder	5x500ul	30400.00

OneMARK 100

Range: 100-3,000 bp
 Number of bands: 12
 Concentration: 90 µg/ml
 Package: 54ug/600ul
 Recommended Load: 6 µl / well
 Containing orange G, xylene cyanol FF as the tracking dyes.
 Storage: 4°C up to 6 month,
 Store at -20°C up to 1 year.

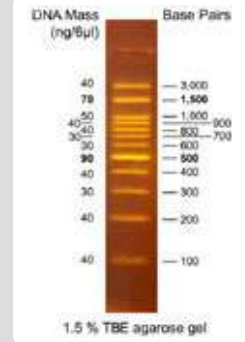

Cat No	Product	Size	Price
CLS101-100	OneMARK100	600ul	3705.00

OneMARK B

Range: 250-10,000 bp
 Number of bands: 13
 Concentration: 83.3 µg/ml
 Package: 50ug/600ul
 Recommended Load: 6 µl / well
 Containing bromophenol blue and xylene cyanol FF as the tracking dyes.
 Storage: 4°C up to 6 month,
 Store at -20°C up to 1 year.

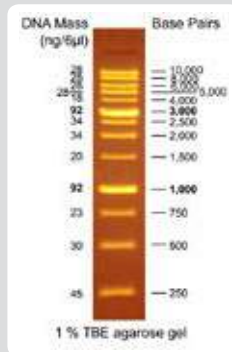

Cat No	Product	Size	Price
CLS110-100	OneMARK B	600ul	3705.00

PiNK Plus Prestained Protein Marker

- Broad range: 10-175 kDa
- Ready-to-use: supplied in a loading buffer for direct loading on gels
- Easy to identify: includes the ~10, ~40 and ~90 kDa reference bands coupled with a blue dye
- Sharp bands

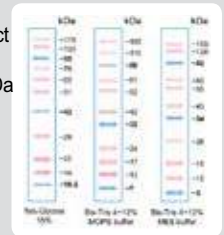

Quality Control: Tested in SDS-polyacrylamide gel electrophoresis and Western blotting.

Recommendations for Loading:

1. Thaw the ladder either at room temperature or at 37-40°C for a few minutes to dissolve precipitated solids. Do not boil.
2. Mix thoroughly to ensure the solution is homogeneous.
3. Load the following volumes of the ladder on SDS-polyacrylamide gel:
 - 5 µl per well for mini-gels, 2.5 µl per well for blots
 - 140 µl per well for large gels, 5 µl per well for blots

Cat No	Product	Size	Price
CLS005-0500	PiNK Plus Prestained Protein Marker	500ul	15675.00

BLUeye Prestained ProteinMarker

- 3 µl or 5 µl per loading for clear visualization during electrophoresis on 15-well or 10-well mini-gel, respectively.
- 1.5~2.5 µl per well for general Western transferring.

Contents: Approximately 0.1~0.4 mg/ml of each protein in the buffer (20 mM Tris-phosphate, pH 7.5 at 25°C), 2 % SDS, 1 mM Dithiothreitol, 3.6 M Urea, and 15 % (v/v) Glycerol).

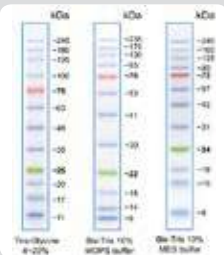

Quality Control: Under suggested conditions, BLUeye Prestained Protein Ladder resolves 12 major bands in 15% SDS-PAGE (Trisglycine buffer) and after Western blotting to nitrocellulose membrane.

Guide for Molecular Weight Estimation (kDa)

Cat No	Product	Size	Price
CLS007-0500	BLUeye Prestained Protein Maker	500ul	17100.00

BLUelf Prestained Protein Marker

- 3 µl or 5 µl per loading for clear visualization during electrophoresis on 15-well or 10-well mini-gel, respectively.
- 1.5~2.5 µl per well for general Western transferring.
- Apply more for thicker (> 1.5 mm) or larger gel.

Contents: Approximately 0.1~0.4 mg/ml of each protein in the buffer (20 mM Tris-phosphate, pH 7.5 at 25°C), 2 % SDS, 10 mM Dithiothreitol, 3.6 M Urea, and 15 % (v/v) Glycerol).



Quality Control: Under suggested conditions, BLUelf Prestained Protein Ladder resolves 13 major bands in polyacrylamide gel with appropriate buffers and after Western blotting to nitrocellulose membrane.

Cat No	Product	Size	Price
CLS008-0500	BLUelf Prestained Protein Ladder	500ul	17955.00

BLUltra Prestained Protein Ladder

- Broad range: 6.5-270 kDa
- Ready-to-use: supplied in a loading buffer for direct loading on gels
- Proteins are covalently coupled with a blue chromophore except for three reference bands (two orange bands at 30 kDa and 270 kDa and one green band at 52 kDa)

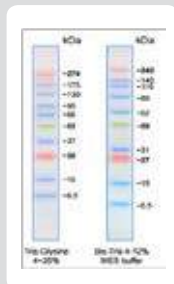

Description The BLUltra Prestained Protein Ladder is designed for monitoring protein separation during SDS-polyacrylamide gel electrophoresis and verifying Western transfer efficiency on membranes (PVDF, nylon, or nitrocellulose) and for approximating the size of proteins.

Quality Control Under suggested conditions, BLUltra Prestained Protein Ladder resolves 10 major bands in 4-12% Bis-Tris Gel (MES buffer) and after Western blotting to the nitrocellulose membrane.

Storage Buffer 62.5 mM Tris-H3PO4 (pH 7.5 at 25 °C), 1 mM EDTA, 2% SDS, 10 mM DTT, 1 mM NaN3, 33% glycerol.

Cat No	Product	Size	Price
CLS003-0500	BLUltra Prestained Protein Ladder	500 µl	15675.00
CLS003-0500	BLUltra Prestained Protein Ladder	500 µl X 5	74100.00

BlueRAY Prestained Protein Ladder

- Broad range: 10-180 kDa
- 3 µl or 5 µl per loading for clear visualization during electrophoresis on 15-well or 10-well mini-gel, respectively
- 2-3 µl per well for general Western transferring.
- Apply more for thicker (>1.5 mm) or larger gel.

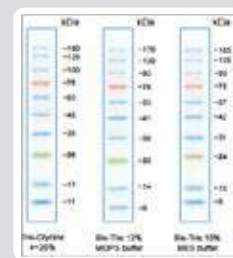

Description The BlueRAY Prestained Protein Ladder is designed for monitoring protein separated during SDS polyacrylamide gel electrophoresis, verification of Western transfer efficiency on membranes (PVDF, nylon or nitrocellulose) and for approximate sizing of proteins

Quality Control 5 µl of BlueRAY Prestained Protein Ladder resolves 10 bands in 4-20% SDS-PAGE (Tris-glycine buffer) and after Western blotting to PVDF membrane

Contents Approximately 0.2-0.4 mg/ml of each protein in buffer (20 mM Trisphosphate pH 7.5 at 25°C), 2% SDS, 0.2 mM Dithiothreitol, 3.6 M Urea, and 15% (v/v) Glycerol.

Cat No	Product	Size	Price
CLS006-0500	BlueRAY Prestained Protein Ladder	500 µl	15675.00
CLS006-0500	BlueRAY Prestained Protein Ladder	500 µl X 5	74100.00

BlueAQUA Prestained Protein Ladder

- Broad range: 10-180 kDa
- 3 µl or 5 µl per loading for clear visualization during electrophoresis on 15-well or 10-well mini-gel, respectively
- 1.5-2.5 µl per well for general Western transferring.
- Apply more for thicker (> 1.5 mm) or larger gel.

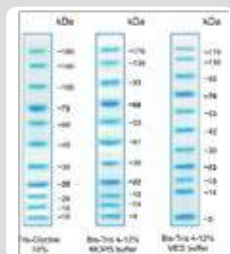

Description The BlueAQUA Prestained Protein Ladder is designed for monitoring protein separation during SDS-polyacrylamide gel electrophoresis, verification of Western transfer efficiency on membranes (PVDF, nylon, or nitrocellulose) and for approximating the size of proteins.

Quality Control Under suggested conditions, BlueAQUA Prestained Protein Ladder resolves 11 major bands in 15% SDS-PAGE (Tris-glycine buffer) and after Western blotting to nitrocellulose membrane.

Contents Approximately 0.1-0.5 mg/ml of each protein in the buffer (20 mM Tris-phosphate, pH 7.5 at 25°C), 2 % SDS, 0.2 mM Dithiothreitol, 3.6 M Urea, and 15 % (v/v) Glycerol).

Cat No	Product	Size	Price
CLS019-0500	BlueAQUA Prestained Protein Ladder	500 µl	15675.00
CLS019-0500	BlueAQUA Prestained Protein Ladder	500 µl X 5	74100.00

OnePAGE Gradient Protein Gels

- Package: Box of 5 gels
- Number of wells: 10 wells
- Outer dimensions: 8 cm X 10 cm
- Thickness of gel layer: 1 mm
- Max loading volume of gel well: 40 µl
- Storage condition: stable at 4°C > 12 months

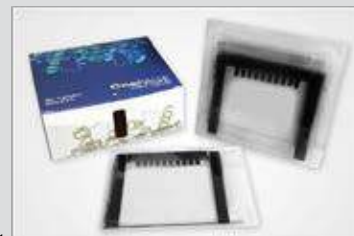

Description OnePAGE Gradient Protein Gels are pre-cast polyacrylamide gels designed to give optimal separation of your small- to medium-sized proteins. Use OnePAGE Gradient Protein Gels for preparing proteins for sequencing, mass spectrometry, and any other techniques where protein integrity is crucial and optimal results during day-to-day use

Quality Control The quality of the OnePAGE Gradient Protein Gels is tested on a lot-to-lot basis to ensure consistent product quality

Cat No	Product	Size	Price
CLS08-10TG	OnePAGE Gradient Protein Gels	5Pcs/Box	14500.00
CLS08-10TG-P	OnePAGE Gradient Protein Gels	1 Pc	3500.00



DNA Loading Dye (6X)

6X DNA Loading Dye is ideal for preparing DNA markers and samples for loading on agarose or polyacrylamide gels. The solution allows for easy visual tracking of DNA migration during electrophoresis.

Specifications

- Easy visual tracking of DNA migration during electrophoresis
- Storage: 4°C up to 12 months



Cat No	Product	Size	Price
CLSD001	DNA Loading Dye (6X)	1mL	1500.00
CLSD010	DNA Loading Dye (6X)	10mL	8500.00
CLSD100	DNA Loading Dye (6X)	100mL	63315.00

Taq DNA Polymerase

Taq DNA polymerase is a thermostable enzyme that catalyzes the polymerization of nucleotides in the 5' to 3' direction at 70-74°C and exhibits a half-time of 30 minutes at 95°C. This enzyme possesses 5'-exonuclease but without 3'-5' exonuclease activity (proofreading activity). The amplified products are up to 8 Kb with 3' adenosine residues and can be used directly in TA cloning.

Storage: -20°C for extended periods

Unit definition: 1 U incorporates 10 NMOL of dNTP into acid insoluble products in 30 minutes at 74°C

Applications: Screening, Primer Extension, Amplification, Terminal dA Tailing



Cat No	Product	Size	Price
CLSQ050	Taq DNA Polymerase	500u	3500.00
CLSQ050	Taq DNA Polymerase	5x500u	15500.00

(pre-mixed w/ MgCl2)

s-Pfu DNA Polymerase

s-Pfu DNA Polymerase is a thermostable enzyme with a molecular weight of 90 kDa. It catalyzes the polymerization of nucleotides into duplex DNA in the 5'>3' direction, resulting in blunt-ended PCR products without 3'-dA overhangs. s-Pfu DNA Polymerase exhibits 3'>5' exonuclease (proofreading) activity that enables the polymerase to correct nucleotide-misincorporation errors, and lacks 5'>3' exonuclease activity. It is suitable for PCR and primer extension reaction that requires high fidelity when the PCR fragment is relatively shorter.

The extension rate of s-Pfu DNA Polymerase is about 600 bp/min in standard condition. The appropriate reaction temperature is 65-75 OC, the work concentration of dNTPs is 100-300µM, the work concentration of Mg2+ is 2-3mM, and the suitable pH is 8.1-9.1. The amount of enzyme is 1-1.5unit for 20µl PCR reaction, while 2-3units for 50µl PCR reaction.

Cat. No.	Product	Size	Price
CLSP-500	s-Pfu DNA Polymersase	500u	10,000.00

Taq-red™ DNA Polymerase

Taq-red DNA Polymerase is an unique blend of U-Taq DNA Polymerase with an inert red dye. It offers the same performance as U-Taq DNA Polymerase. Several benefits are as follows:

This red dye enables quick and convenient visual confirmation of enzyme addition and reaction mixing.

1. After PCR amplification, samples can be removed from the reaction and loaded directly onto agarose gel without the addition of loading buffer or tracking dye. The red dye, acting as a tracking dye, migrates between bromophenol blue and xylenecyanol at about the same rate as 400-500 bp fragment.
2. The concentration of Taq-red is only 1unit/µl, so the enzyme can be transferred and added more accurately.
3. The enzyme generates PCR products with 3'-dA overhangs, suitable for T-A cloning.
4. 6 kb Lambda DNA and 2.1 kb Human genomic DNA can be amplified very well at our laboratory.

Cat. No.	Product	Size	Price
CLSR-500	Taq-red™ DNA Polymerase	500u	6000.00

Pfu DNA Polymerase

Pfu DNA polymerase is isolated from the hyperthermophilic marine archaeobacterium. Pyrococcus furiosus. The multi functional thermostable enzyme possesses both 5'- to 3'- DNA polymerase and 3'- to 5'- exonuclease activity, which results in a 12-fold increase in fidelity of DNA synthesis over Pfu DNA polymerase. Cloned Pfu DNA Polymerase has a temperature optimum between 72 °C and 78 °C remains > 95% active following a one hour incubation at 95 oC.

Storage: -20°C for extended periods



Cat No	Product	Size	Price
CLS0093	Pfu DNA Polymerase 5u/ul	100u	6825.00
CLS0093	Pfu DNA Polymerase 5u/ul	500u	23400.00

Hotstart Taq DNA Polymerase

Hotstart Taq DNA Polymerase is a chemically modified Taq DNA Polymerase whose enzyme activities can only be activated after 3-5 minutes of incubation at 94°C. This enzyme thus exhibits no polymerase activities before the onset of thermal cycling, preventing nonspecific DNA amplification and primer dimer formation. PCR products, amplified up to 6kb in length with Taq DNA Polymerase, generate a single base (A) 3' overhang. Storage: -20°C for extended periods



Cat No	Product	Size	Price
CLS3GHST81	3G Hotstart Taq	500u	41652.00
CLS3GHST81	DNA Polymerase 5u/ul	5x500u	187434.00

dNTP Mix

10 mM dNTPs Mix is a ready-to-use solution of dATP, dCTP, dGTP and dTTP (monosodium salts) at a concentration of 10 mM each in sterile deionized water at pH7.5, whose purity is ≥99% (HPLC). It is free of RNase and DNase, and is suitable for any molecular biology application that requires pure deoxynucleotides, such as PCR, DNA sequencing, cDNA synthesis and nick translation. Storage: Store at -20. Storage: -20°C for extended periods



Cat No	Product	Size	Price
CLS-1	dNTP Mix (SBS)	1mL	4500.00

dNTP Separate

dNTPs in Individual Tube contains 4×0.4 ml of dATP, dCTP, dGTP and dTTP (monosodium salts) at a concentration of 100 mM each in sterile deionized water at pH7.5, whose purity is ≥99% (HPLC). It is free of RNase and DNase, and suitable for any molecular biology application that requires pure deoxynucleotides, such as PCR, DNA sequencing, cDNA synthesis and nick translation. Storage: -20°C for extended periods



Cat No	Product	Size	Price
CLS-2	dNTP Separate (SBS)	4x0.4 mL	12500.00

PCR SuperMix

PCR SuperMix provides qualified reagents for the amplification of nucleic acid templates by the polymerase chain reaction (PCR). PCR Super Mix contains Mg⁺⁺, dNTPs, and recombinant Taq DNA Polymerase at concentrations sufficient to allow amplification during PCR. PCR Super Mix is supplied at 1.1X concentration to allow approximately 10% of the final reaction volume to be used for the PCR. Storage: Room Temperature



Cat No	Product	Size	Price
CLSB200	PCR Super Mix	100 rxn	12825.00

One PCR

Only add your templates and primers. No Fluorescent gel staining needed



Application:

- No post-staining processing of DNA required.
- No need to prepare PCR Reagents.
- Direct loading onto your agarose gel for analysis.

Storage: Room Temperature for 3 months, -20°C up to 1 year

Cat No	Product	Size	Price
CLSB203-0100	One PCR	100 rxn	6500.00

OnePCR HiFi

One PCR HiFi is a ready-to-use PCR reaction mixture. Simply adding primers and template, the reagent will execute primer extensions and other molecular biology applications. One PCR HiFi is a pre-mixed solution containing GDP-HiFi DNA polymerase, PCR buffer, dNTPs, gel loading dyes, enhancer, and fluorescence dye. It contains the fluorescence dye, which is directly detected on the blue-light transilluminator or UV epi-illuminator after the DNA electrophoresis. The One PCR HiFi mixture is supplied at the 2X concentration to allow approximately 50% of the final reaction volume to be used for the addition of the primer and template solutions. Reagents are provided with sufficient amplification

Features

- No post-staining procession.
- No need to prepare PCR reagents.
- Direct loading onto your agarose gel for analysis.
- Sensitivity- High degree of sensitivity as the ethium bromide.
- Time Efficiency- No destaining requirement.
- Compatibility – Use the Blue Light or UV to detect the signal.
- Effective for the amplification of GC-rich targets.
- Exhibits strong 3'>5' exonuclease activity.



Cat No	Product	Size	Price
CLSB205-0100	One PCR HiFi supermix W fluorescent dye	100RXN	12825.00



OnePCR HotStar

One PCR Hot Star is a ready-to-use PCR reaction mixture. Simply add primers, template, and water, the reagent will execute primer extensions and other molecular biology applications. One PCR Hot Star is a pre-mixed solution containing Hot start Taq DNA polymerase, PCR Buffer, dNTPs, gel loading dyes, and fluorescence dye. One PCR Hot Star, which contains the fluorescence dye, is directly detected on BLook LED transilluminator or UV epi-illuminator after the DNA electrophoresis.



Application

- No post-staining processing of DNA required.
- No need to prepare PCR Reagents.
- Direct loading onto your agarose gel for analysis.
- Sensitivity – High degree of sensitivity as the ethium bromide.
- Speed – No de-staining requirement.
- Compatibility – Use the Blue Light or UV to detect the signal.

Cat No	Product	Size	Price
CLSB206-0100	One PCR Hot Star supermix W fluorescent dye	100 rxns (2.5ml)	21375.00

OnePCR Plus

One PCR Plus is a ready-to-use PCR reaction mixture. Simply add primers, template, and water, the reagent will execute primer extensions and other molecular biology applications. One PCR Plus is a pre-mixed solution containing Taq DNA polymerase, PCR buffer, dNTP, gel loading dyes, enhancer, and fluorescence dye. One PCRTM Plus which contains the Taq DNA polymerase, is purified from the E. coli., and expressing the Thermus aquaticus DNA polymerase gene. This enzyme has a 5'>3' DNA polymerase and the 5'>3' exonuclease activity but lacks the 3'>5' exonuclease activity. One PCR Plus, which contains the fluorescence dye, is directly detected on BLook LED transilluminator or UV epiilluminator after the DNA electrophoresis.



Application

- No post-staining processing of DNA required.
- No need to prepare PCR Reagents.
- Direct loading onto your agarose gel for analysis.
- Sensitivity – High degree of sensitivity as the ethium bromide.
- Speed – No de-staining requirement.
- Compatibility – Use the blue light or UV to detect the signal.

Cat No	Product	Size	Price
CLSB207-0100	One PCR Plus supermix W fluorescent dye	100 rxns (2.5ml)	8500.00

PCR Dye

PCR Dye is an inert red dye, which can be added into PCR reaction and makes performance more convenient. The recommended amount is 1/10 of reaction volume. After PCR, samples can be removed from the reaction and loaded directly onto agarose gel. The red dye, acting as a tracking dye, migrates between bromophenol blue and xylenecyanol at about the same rate as 400~500 bp fragment.

Cat. No.	Product	Size	Price
CLSD-1	PCR Dye	1ml	1400.00

Green-2-GO qPCR Master mix

Green-2-Go qPCR Mastermix is a convenient premix of all the components, 2X mix of dNTPs, Hot start Taq polymerase, MgCl₂, fluorescent detection dye, reference dye, and proprietary buffer components. The components of Green-2-Go qPCR Master Mix have been developed for superb performance in sensitivity, signal-to-noise ratio, and complete elimination of primer dimers. The chemically modified Hot start Taq polymerase included in our master mix significantly reduces non-specific PCR amplification observed with regular Taq polymerase. Due to variations in qPCR instruments, we offer different Green-2-Go qPCR Master mix formulations optimized for different machines. Please use the following table as a guideline for the selection of qPCR Master mix appropriate for your particular instrument model.



Storage: -20°C for extended periods

Cat No	Product	Size	Price	Price
CLSPCR1-R (2X)	Green-2-Go qPCR -ROX	ABI® 7000, 7300, 7700, 7900; StepOnePlus™ StepOne; Eppendorf® Realplex 4	4 x 1.25 ml	54522.00
CLSPCR2-L (2X)	Green-2-Go qPCR Low ROX	ABI® 7500; Stratagene® Mx3000, Mx3005, Mx4000	4 x 1.25 ml	54522.00
CLSPCR3-IC (2X)	Green-2-Go qPCR iCycler	BioRad® iCycler®, iQTM5, MyiQTM	4 x 1.25 ml	54522.00
CLSPCR4-S (2X)	Green-2-Go qPCR-S	BioRad® CFX96; Roche LightCycler® 480, MJ Research Opticon™ and Opticon™ 2; MJ research Chromo® 4; Corbett Rotor-gre® 600, 3000; Eppendorf® Realplex 2	4 x 1.25 ml	54522.00

RT-PCR Kit

One-Step AMV/ M-MULV RT-PCR offers a unique system for performing RT-PCR in a single step, in a single tube. Traditionally, RT-PCR is performed in two reaction steps. In the initial reaction, first-strand cDNA is reverse transcribed from total or poly(A) RNA. Then, in a separate reaction, the cDNA is amplified by PCR using a Taq DNA polymerase. This kit allows cDNA synthesis and PCR to be performed in a single optimized buffer, with AMV/ M-MULV RT and Taq DNA polymerase. No additional reagents are required after the reaction is initiated. This method reduces the possibility of cross-contamination and provides a very convenient technique for gene expression.



Storage: -20°C

Cat No	Product	Size	Price
CLSB300-0050	One Step RT-PCR System	50 rxn	26500.00
CLSS6649	One Step AMV-RT-PCR Kit	100 rxn	93600.00
CLSS665	One Step M-MULV RT-PCR Kit	100 rxn	93600.00

Two-Step RT-PCR Kit

The Two-Step RT-PCR Kit has all the components required to perform First-strand cDNA synthesis followed by amplification of the cDNA product using a two-step process. In the first step, M-MLV Reverse Transcriptase is used to synthesize a DNA copy of input RNA. M-MLV RTase is a frequent choice for cDNA synthesis because of its ease of use and low intrinsic RNase activity. Oligo(dT)18 primers direct synthesis of a complementary strand of poly(A)⁺ mRNA. Random nonamer primers direct synthesis of sequences complementary to all RNA present in the reaction.

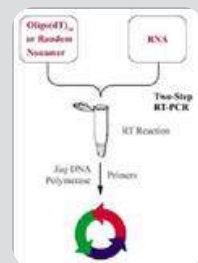

In the PCR step, a portion of the cDNA product is amplified using U-Taq DNA polymerase and input primers. U-Taq polymerase, buffer, dNTPs are included in this kit.

Key Features:

Optimized for high performance using M-MLV Reverse Transcriptase and Taq DNA polymerase.

Choice of priming methods: oligo(dT)18, random nonamer or gene-specific primers. Amplifies targets up to 1.5 kb very well at our laboratory.

Cat No	Product	Size	Price
CLSTRP-25	Two-Step RT-PCR Kit	25 rxn	36,800.00

TOPscript™ cDNA synthesis kit

Experimental procedure (Block PCR)

For cDNA synthesis, RT reaction was performed at 50°C temperature by using TOPscript™ cDNA synthesis kit and competitor's product with indicated amount of Hela total RNA. nTaq-Tenuto (Cat#. P225) was used for the subsequent PCR.

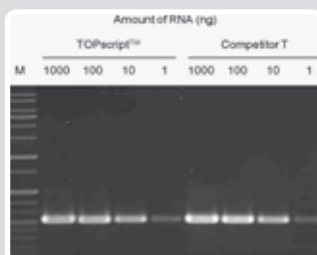

Result

TOPscript™ cDNA synthesis kit was shown as similar performance compare to the world best competitors.

Storage: -20°C

Cat No	Product	Size	Price
CLSB100	TOPscript™ cDNA synthesis kit	100 rxn	68500

Site-Directed Mutagenesis Kit

The Site-Directed Mutagenesis Kit can induce mutagenesis at the specific point of sequence that cloned on plasmid DNA. It guarantees 100% of efficiency in theory. Also it is very convenient and simple because it takes just two steps for all experimental procedures. The Site-Directed Mutagenesis Kit does not necessary using M13 vector and methylation step. Indeed, the Kit can induce mutation of nucleotide, re-mutation to wild type, mutation of codon and insertion even deletion. As the Kit has these characteristics, it is applicable to analysis for genomic/proteomic function. Also as inducing mutagenesis of specific gene, it can be used for protein engineering like protein development or improving productivity.

When you use this the Kit, you can have mutated clone as doing simple steps. (Design primer with own protocol, use the Enzyme for 15~18 cycles of PCR. Proceed transformation step after the Mutazyme treatment for mutated clone selection) In this theory, clones on LB agar plate are mutated around 100% and after sequencing, you can proceed to the next step.

Cat No	Product	Size	Price
CLSDM-15	Site-Directed Mutagenesis Kit	15 rxn	62500.00

Easy-Go™ RT PreMix

Easy-Go™ RT Pre Mix is a new, powerful, ready-to-use RT kit for the synthesis of cDNA with superiority to other RT products.

Advantages : Speed Substantial reduction in reaction setup time.

Stability As each tube of Easy-Go™ RT Pre Mix contains a stabilizer, which can maintain the stability of the RTase up to a year at -20oC.

Description : 0.5ml thin wall micro tube, 20µl reaction
0.2ml thin wall micro tubes, 20µl reaction

Cat No	Product	Size	Price
CLSRT-2.5	Easy-GO™ RT Pre Mix	25 tubes	24,000.00
CLSRT-2.2	Easy-GO™ RT Pre Mix	25 tubes	24,000.00

Easy-Go™ RT-PCR PreMix

Easy-Go™ RT-PCR Pre Mix contains all the components necessary for cDNA synthesis and amplification in one tube.

Advantages : Speed Substantial reduction in reaction setup time.

Stability As each tube of Easy-Go™ RT-PCR Pre Mix contains a stabilizer, which can maintain the stability of the RTase and DNA polymerase up to a year at -20oC. RTase inactivation prior to PCR has no effects on the activity of the DNA polymerase.

Description : 0.5ml thin wall micro tube, 20µl reaction
0.2ml thin wall micro tubes, 20µl reaction

Cat No	Product	Size	Price
CLSRTP-2.5	Easy-GO™ RT-PCR Pre Mix	25 tubes	41,500.00
CLSRTP-2.2	Easy-GO™ RT-PCR Pre Mix	25 tubes	41,500.00



Novel Juice

Supplied in 6X Loading Buffer

Description

Novel Juice is a non-mutagenic fluorescent reagent that produces instant visualization of DNA bands upon Blue Light or UV illumination of agarose gels. Supplied in GeneDireX's 6X DNA Loading Buffer, Novel Juice is used to prepare DNA markers and samples for loading on agarose or polyacrylamide gels. Novel Juice is the most sensitive stain available for detecting the double-stranded DNA (dsDNA). It contains three tracking dyes (Bromophenol Blue, Xylene Cyanol FF, and Orange G) for visually tracking the DNA migration during the electrophoresis process. It is ideal for the environment requiring a safe, non-hazardous alternative to Ethidium Bromide. **Novel Juice keeps your lab safe**



Cat No	Product	Size	Price (₹)
CLS002-0500	Novel Green (10000X)	500ul	24225.00

Novel Green Plus (Syber Green)

The Novel Green Plus provides an easy 2-step method to stain the DNA band from DNA electrophoresis. This unique reagent ensures the DNA to be stained with a high sensitivity and good quality on the gel. Novel Green Plus is a next-generation DNA-binding dye with features ideal for use in quantitative real-time PCR (qPCR) and many other applications. We designed the dye by taking into consideration several essential dye properties relevant to PCR, including PCR inhibition, safety, and stability and fluorescence spectra of the dye. Ethidium bromide (EtBr), which presents sensitivity for detecting 1-5 ng double-stranded DNA (dsDNA) in the agarose gel analysis, has been the most common dye used for nucleic acid gel staining.

However, several drawbacks of EtBr have been understood, including that EtBr is a mutagen/carcinogen and presents a high risk of inducing cancer. Moreover, the ultraviolet (UV) light used to illuminate EtBr-DNA compounds probably results in skin or eye damage to the user if misconducted. It's also noted that exposure to the UV light might cause chemical modifications of the DNA samples in the gel, such as the formation of TT dimers, leading to challenges with the subsequent DNA manipulations. Reduced efficiency of transformation is observed by our scientists, after conducting ligation with the DNA samples isolated from the gel exposed to a longer period of UV illumination.

Storage: Stable for up to 1 year at -20°C, Shipping Temperature: Room temperature

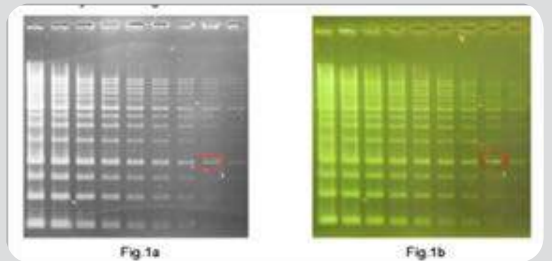

Cat No	Product	Size	Price
CLS003-0500	Novel Green Plus	500ul	24225.00

Novel Green (10000X)

The Novel Green provides an easy 2-step method to stain the DNA band from DNA electrophoresis. This unique reagent ensures the DNA to be stained with a high sensitivity and good quality from the gel. Novel Green is a next-generation DNA-binding dye with features ideal for use in quantitative real-time PCR (qPCR) and many other applications. We designed the dye by taking into consideration several essential dye properties relevant to PCR, including PCR inhibition, safety, and stability and fluorescence spectra of the dye. Ethidium bromide (EtBr), which presents sensitivity for detecting 1-5 ng double-stranded DNA (dsDNA) in the agarose gel analysis, has been the most common dye used for nucleic acid gel staining. However, several drawbacks of EtBr have been understood, including that EtBr is a mutagen/carcinogen and presents a high risk of inducing cancer. Moreover, the ultraviolet (UV) light used to illuminate EtBr-DNA compounds probably results in skin or eye damage to the user if misconducted. It's also noted that exposure to the UV light might cause chemical modifications of the DNA samples in the gel, such as the formation of TT dimers, leading to challenges with the subsequent DNA manipulations. Reduced efficiency of transformation is observed by our scientists, after conducting ligation with the DNA samples isolated from the gel exposed to a longer period of UV illumination.

Storage: Stable for up to 1 year at -20°C, Shipping Temperature: Room temperature

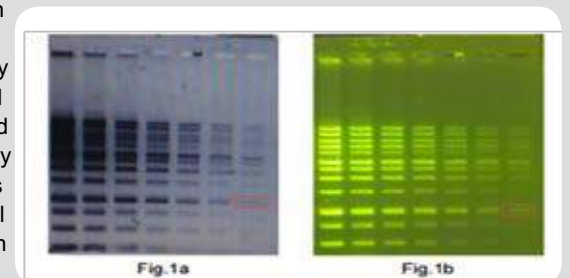

Cat No	Product	Size	Price
CLS002-0500	Novel Green (10000X)	500ul	24225.00

Nimble Juice

Nimble juice is a fast and sensitive fluorescent dye for visualization and quantitation of proteins separated by 1-D or 2-D SDS-PAGE. It comes as a 100x stock solution

that is simply diluted with water by the user to its working concentration. Nimble juice is normally low fluorescent but emits strong fluorescence (bright golden color) as bound to proteins. The staining procedure is a simple two-step protocol (ix and stain)

that can be completed in as little as 30 minutes. Gels to be stained are fixed with ethanol/acetic acid solution prior to staining with Nimble juice solution. A destain step is not normally recommended, but may be employed to reduce background, simply by agitating the gel in water for 1-5 minutes. Gels stained with Nimble juice fluorescent gel stain may be directly visualized with a variety of different UV-based fluorescence imaging systems. The maximum emission wavelength of protein-bound Nimble juice is near 570 nm. Nimble juice gives exceptional sensitivity and wide dynamic range for protein detection. The bound Nimble juice dye is easily removed from the protein by immersing the gel in sufficient water, thus it is well compatible with subsequent enzymatic digestion and mass spectrometry for proteomics applications. Stained gels may be stored in stain solution in the dark at 2-8°C; imaging sensitivity might be moderately enhanced after 4°C storage of the stained gel.

Storage: The product is stable for at least 6 months when stored at 2-8°C. Avoid exposure to temperatures greater than 37°C and protect from light.



Nimble juice is a fast and sensitive fluorescent dye for visualization and quantitation of proteins separated by 1-D or 2-D SDS-PAGE

Cat No	Product	Size	Price
CLS001-0010	Nimble Juice	10mL (100X)	25650.00
CLS002-0500	Nimble Juice R Type	500 ML	12825.00

Agarose LE

All applications for agarose take advantage of the special characteristics of the macroreticular gel. It is used as a sieve or support through which biological macromolecules such as proteins or nucleic acid can pass. Larger particles, such as viruses and subcellular fragments, are also able to move through the gel network. Agarose LE is optimized for pulsed-field electrophoresis. This product has an exceptionally low EEO and high gel strength, both of which facilitate the preparation of low concentration gels for resolving Large fragments (>20kb). Gel strength (1.5%) >2200g/cm²



Cat No	Product	Size	Price
CLS0015	Agarose, LE	100 gm	8190.00
CLS0015	Agarose, LE	500 gm	23400.00

RNase A (Powder)

Grade: Biotech
 Appearance: White lyophilized powder
 Activity (Kunitz, Protein@37°C): >60u/mg
 Loss on drying: <5.0%
 Dnase: Not Detected
 Solubility(1%,water): Pass
 Storage: -20°C. Keep dry. Warm to room temperature before opening



Cat No	Product	Size	Price
CLS0473A	RNase A	25 mg	5220.00
CLS0473A	RNase A	100 mg	15660.00

RNasin (RNase inhibitor)

Electrophoresis grade

RNasin is a ribonuclease inhibitor extracted from human placenta with a molecular weight 51 kDa. It inhibits the activity of RNase by specifically binding up to RNase with a non-covalent bond. RNasin, free of RNase or Nickase, can maintain its activity at pH from 5 to 8, and the highest one at pH7.8. The concentration of RNasin is 20~40 units/μl. Store at -20oC.

Unit Definition

One unit is defined as the amount of enzyme required to incorporates 1 nmol of dTTP into acid-precipitable material in 10 min at 37oC using poly(A)+ RNA and oligo(dT)18 as template/primer.

Quality Assurance

Dnase and RNase activity is not detected after incubation of 1 μg of DNA and RNA with 200 units of M-MLV Reverse Transcriptase for 3 hours at 37~42°C.

Cat No	Product	Size	Price
CLSRN-1k	RNasin (RNase inhibitor)	1,000 U	8,000.00

RNase A Solution 10mg/mL

Grade: Biotech
 Appearance: Colorless haze-free liquid
 Activity (Kunitz, Protein@37°C): >60u/mg
 Endonuclease: Not Detected
 pH at 25¼ C: 7.0 - 8.0
 Dnase: Not Detected
 Highly purified by: affinity chromatography
 Storage: -20°C. Keep dry. Warm to room temperature before opening



Cat No	Product	Size	Price
CLS0474	RNase A Solution 10 mg/mL	1mL	2088.00



M-Mulv Reverse Transcriptase (Rnase H Minus)

Bio Basic Reverse Transcriptase is a newly-engineered version of Moloney Murine Leukemia Virus (M-MuLV) reverse transcriptase with the highest thermal stability and least RNase H activity. It can be used to synthesize first strand cDNA by reverse transcription (RT) at a higher temperature for difficult RNA transcription and to get higher yields. It has a broad working temperature range from 37°C to 60°C, with cDNA product size up to 12Kb. The optimal first-strand cDNA synthesis temperature for this enzyme is around 50°C.



Storage: -20°C

Cat No	Product	Size	Price
BCB1552	M-Mulv Reverse Transcriptase 200u/ul	2KU	12870.00
BCB1553	M-Mulv Reverse Transcriptase 200u/ul	10KU	64350.00

AMV Reverse Transcriptase

A DNA polymerase which catalyzes the polymerization of DNA, using DNA, RNA or DNA: RNA hybrids and templates. Besides possessing 5'-3' DNA polymerase activity, the enzyme also possesses some RNase H activity which breaks apart RNA: DNA hybrids. It is used primarily for the synthesis of first and second strand cDNA and primer extensions. To a lesser extent, it is used for RNA sequencing and the preparation of probes for hybridization.



Storage: -20°C

Cat No	Product	Size	Price
BCB0999	Amv Reverse Transcriptase 10u/ul	200u	18720.00
BCB0999	Amv Reverse Transcriptase 10u/ul	1KU	74880.00

Trizol

The Trizol RNA Purification Kit provides a simple, reliable, and rapid method for isolating high-quality total RNA from a wide variety of samples, including animal and plant cells and tissue, bacteria, and yeast.

Storage: Store at 2-8°C, protect from light for up to 12 months.

Recommended volume of Trizol on different starting materials

10 cm ² adherent cells	1 mL	50-100 mg ordinary tissue	1mL
107 suspension cells	1-2 mL	50-100 mg special tissue (live, spleen, bone or cartilage)	2mL
100 µl white cells	2 mL	15-100 mg plant tissue	1 mL

Cat No	Product	Size	Price
BR100	Trizol	100 mL	11500.00



Total Protein Extraction Kit

The total Protein extraction Kit provides an optimized cell lysis buffer, protease inhibitor cocktail and Phosphatase inhibitor for convenient extraction of mammalian proteins from cultured cells and tissue samples, under non-denaturing conditions. Total protein isolated by this kit maintain biological activity and can be used for many downstream applications including SDS-PAGE, Western Blotting, IP, Pull Down, Gel Mobility Shift, protein assays and so on. The kit is sufficient to extract proteins from 50x 107mammalian cells or 50x200mg of tissues sample.



Storage: -20°C

Cat No	Product	Size	Price
BCBSP003	Total Protein Extraction Kit	50 rxn	17136.00

Plant Protein Extraction Kit

The Plant Protein Extraction Kit provides rapid recovery (as few as 20 minutes) of soluble proteins from plant tissue samples. The final protein extract is compatible with many downstream applications, including SDS-PAGE, 2-D gel electrophoresis, Western blotting, activity assays and a nitry purification. The Kit includes three components: an organic solution to lyse plant cells, an aqueous buffer to gently solubilize proteins and a protein-stabilizing reagent. The Kit has been tested on leaves, roots, flowers and seeds from various species, including Arabidopsis, tobacco, spinach, peas and soybeans. Extremely fibrous tissue samples, such as woody stems, may require additional mechanical grinding by devices not included in the kit. Depending on the particular application, additional components, such as phosphatase inhibitor and chelating agents may be added to the buffer. The kit is sufficient to extract protein from either 20 x 40 mg of fresh/frozen plant tissue or 20 x 10 mg of dried plant tissue.



Storage: -20°C

Cat No	Product	Size	Price
BCBSP004	Plant Protein Extraction Kit	20 rxn	17640.00



Good View™ Nucleic Acid Stain



Good View™ Nucleic Acid Stain - An alternative to EtBr SBS Genetech

Good View Advantage:

1. Good View™ is noncarcinogenic in nature.
2. Good View™ allows visualization of DNA (>50ng) in the agarose gel under visible light.
3. Good View emits green fluorescence when bound to dsDNA and red fluorescence when bound to ssDNA or RNA.
4. 1ml of Good View™ is sufficient for 20L of agarose gel.

The agarose gel indicates the sensitivity of Gold View is equivalent to that of EB.

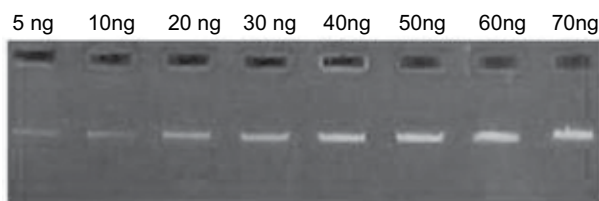

Sensitivity detection of Good View under UV transmission (wavelength 300 nm)

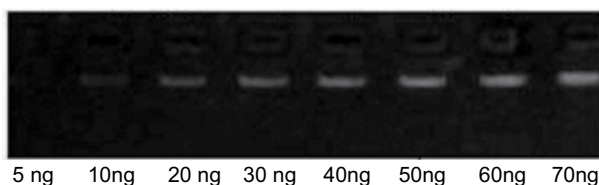

Sensitivity detection of EB under UV transmission (wavelength 300 nm)

Order Information

Cat No	Product	Size	Price (₹)
CLS-II	Good View™ Nucleic Acid Stain An alternate to EtBr	1ml	5500.00



HOT SELLING RANGE

CAT NO.	DESCRIPTION	PK SIZE	PRICE
CLS1200	ACETONE	1L	3,920.00
CLS1032	ACRYLAMIDE	250G	6,281.00
CLS1032	ACRYLAMIDE	1KG	18,843.00
CLS0025	BIS-ACRYLAMIDE	50G	5,616.00
CLS0025	BIS-ACRYLAMIDE	250G	21,060.00
CLS0044	BORIC ACID	500G	3,744.00
CLS2230	BROMOPHENOL BLUE	25G	5,148.00
CLS0110	CHAPS	1G	2,340.00
CLS0110	CHAPS	5G	9,360.00
CLS0055A	CITRIC ACID	1KG	7,020.00
CLS0038	COOMASSIE BRILLIANT BLUE G-250	25G	6,786.00
CLS0037	COOMASSIE BRILLIANT BLUE R-250	5G	2,340.00
CLS0037	COOMASSIE BRILLIANT BLUE R-250	25G	6,786.00
CLS0108	CTAB	100G	2,356.00
CLS0108	CTAB	500G	9,620.00
CLS3000	CHLOROFORM	500ML	4,760.00
CLS3000	CHLOROFORM	1L	9,520.00
CLS0140	DAB TETRAHYDROCHLORIDE	5 G	7,308.00
CLS0154	DEPC	5ML	3,672.00
CLS0154	DEPC	25ML	11,873.00
CLS0231	DIMETHYL SULFOXIDE (DMSO)	500ML	5,382.00
CLS0185	EDTA, DISODIUM SALT, DIHYDRATE	500G	5,382.00
CLS0195	ETHIDIUM BROMIDE [EB; ETBR]	1G	2,355.00
CLS0195	ETHIDIUM BROMIDE [EB; ETBR]	5G	9,404.00
CLS0212	FORMAMIDE	500ML	8,160.00
CLS0213	D(-)-FRUCTOSE	500G	2,574.00
CLS0213	D(-)-FRUCTOSE	2.5KG	11,232.00
CLS0219	D-GLUCOSE, ANHYDROUS	1KG	4,680.00
CLS0232	GLYCEROL	500ML	4,212.00
CLS0235	GLYCINE	500G	5,148.00
CLS0235	GLYCINE	2.5KG	20,592.00
CLS0264	HEPES, FREE ACID	250G	13,572.00
CLS0277	IMIDAZOLE	100G	5,040.00
CLS0277	IMIDAZOLE	500G	19,600.00
CLS0278A	ISO-PENTYL ALCOHOL [ISOAMYL ALCOHOL]	500ML	2,900.00
CLS0918	ISOPROPANOL	500ML	4,480.00
CLS8601	ISO-PROPANOL (2-PROPANOL)	500ML	3,780.00
CLS0308A	LYSOZYME	1G	2,784.00
CLS0308A	LYSOZYME	5G	8,004.00
CLS0328A	MAGNESIUM CHLORIDE, HEXAHYDRATE	500G	3,744.00
CLS0338	B-MERCAPTOETHANOL	100ML	2,355.00
CLS0425	PMSF	5G	8,960.00
CLS0451	PROTEINASE K	50MG	14,268.00
CLS0451	PROTEINASE K	100MG	21,182.00
CLS0485	SDS	100G	3,920.00
CLS0485	SDS	500G	13,440.00

CAT NO.	DESCRIPTION	PK SIZE	PRICE
CLS0483B	SODIUM CHLORIDE	500G	1,872.00
CLS0483B	SODIUM CHLORIDE	2.5KG	8,190.00
CLS0498	SUCROSE	500G	2,106.00
CLS0498	SUCROSE	2.5KG	8,424.00
CLS0508	TEMED	25ML	1,812.00
CLS0508	TEMED	100ML	6,040.00
CLS0195A	TRIS	500G	6,084.00
CLS0195A	TRIS	2.5KG	26,442.00
CLS0103	TRIS HYDROCHLORIDE	250G	5,382.00
CLS0198	TRITON X-100	500ML	2,574.00
CLS560A	TWEEN 20	500 ML	3,510.00
CLS0562	TWEEN 80	500 ML	3,042.00
CLS0148	UREA	500G	2,223.00
CLS0148	UREA	2.5KG	10,530.00

ANTIBIOTICS

CAT NO.	DESCRIPTION	PK SIZE	PRICE
CLS0028A	AMPICILLIN, SODIUM SALT USP	25G	10037.00
CLS0721	AMPICILLIN, SODIUM SALT SOLUTION (10MG/ML)	10ML	2938.00
CLS0064	AMPICILLIN, TRIHYDRATE	25G	4406.00
CLS0469	CARBENICILLIN, DISODIUM SALT	1G	14688.00
CLS0469	CARBENICILLIN, DISODIUM SALT	5G	58752.00
CLS0118	CHLORAMPHENICOL	50G	4680.00
CLS0118	CHLORAMPHENICOL	250G	20826.00
CLS0160	DEXTRAN SULFATE	10G	4896.00
CLS0160	DEXTRAN SULFATE	50G	17136.00
CLS0160	DEXTRAN SULFATE	250G	82824.00
CLS0217B	GENTAMYCIN SULFATE	1G	1224.00
CLS0217B	GENTAMYCIN SULFATE	5G	2448.00
CLS0217B	GENTAMYCIN SULFATE	25G	9792.00
CLS0286	KANAMYCIN SULFATE	5G	2448.00
CLS0286	KANAMYCIN SULFATE	25G	7344.00
CLS0286	KANAMYCIN SULFATE	100G	23501.00
CLS0366	NEOMYCIN SULFATE	25G	3744.00
CLS0366	NEOMYCIN SULFATE	100G	13338.00
CLS0727	NEOMYCIN SULFATE, STERILE	10ML	2938.00
CLS0135	PENICILLIN G, SODIUM SALT	25G	2808.00
CLS0135	PENICILLIN G, SODIUM SALT	100G	8424.00
CLS2074	POLYMYXIN B SULFATE	25MU	40882.00
CLS2074	POLYMYXIN B SULFATE	100MU	136598.00
CLS0808A	RIFAMPICIN	25G	12974.00
CLS0807	RIBOSTAMYCIN SULFATE SALT	5G	4162.00
CLS0807	RIBOSTAMYCIN SULFATE SALT	25G	12974.00
CLS06203	RAPAMYCIN	100MG	114840.00
CLS0504	TETRACYCLINE HYDROCHLORIDE	25G	4176.00
CLS0504	TETRACYCLINE HYDROCHLORIDE	100G	12180.00
CLS0983	VANCOMYCIN HYDROCHLORIDE	1G	15312.00

Cell Culture Flask with Filter or Vent/Close Caps (Cell Culture Treated)

For more than a century, cells have provided humanity with deep and fascinating insights into the nature. Being a common laboratory technique, cell culture is one of the most critical aspects in biology-related research and industrial. We provide our customers with a wide range of high quality cell culture products, including cell culture flasks, cell culture dishes, microplates, cryovials and other essential accessories. All our products meet the international guidelines including those of ISO 9001 and USP

Manufactured from optically clear virgin polystyrene, Ergonomic design to facilitate easy handling and minimize contamination, Short & wide neck with angled design allow easy access, Plugs & filter caps are available for all flask models, Sterilized, Non – pyrogenic & Non – cytotoxic, Cell growth area ranging from 25 cm² to 175 cm²



Cat No.	Description	Pack	Unit Price	HSN
CLSCF001	Cell Culture Flask 25Cm ² , cap Vent close	100	8362.00	39269099
CLSCF002	Cell Culture Flask 25 Cm ² , Fiter cap,	100	8461.00	39269099
CLSCF003	Cell Culture Flask 75 Cm ² , cap vent close,	100	5678.00	39269099
CLSCF004	Cell Culture Flask 75 Cm ² , Fiter cap,	100	8561.00	39269099
CLSCF005	Cell Culture Flask vent/close cap 175/225Cm ²	100	10932.00	39269099
CLSCF006	Cell Culture Flask 25cm with Filter, sterile	200	19494.00	39269099
CLSCF007	Cell Culture Flask 75cm with Filter, sterile	100	15214.00	39269099
CLSCF008	Cell Culture Flask 175Cm ² with Filter, sterile	30	8974.00	39269099
CLSCF009	Cell Culture Flask 225Cm ² with Filter, sterile	30	20123.00	39269099
CLSCF010	Cell Culture Flask 25 vent close, sterile	200	16711.00	39269099
CLSCF011	Cell Culture Flask 75 vent close, sterile	100	15214.00	39269099
CLSCF012	Cell Culture Flask 175 vent close, sterile	30	8974.00	39269099
CLSCF013	Cell Culture Flask 225 vent close, sterile	30	15587.00	39269099



Cell Culture Dishes (Cell Culture Treated)

CLS cell culture products allow researchers to acquire high resolution microscopic images of cells in 35 mm culture dishes or 6 well plates. We provide two types of confocal products with cover glasses of different thicknesses.

Cat No.	Description	Pack	Unit Price	HSN
CLSCD001	TC Dish 35X10 Delta Sterile	500	19681.00	39269099
CLSCD002	35X10mm Suspension Dish	500	33680.00	39269099
CLSCD003	TC Dish 60X15 Delta Sterile	400	11282.00	39269099
CLSCD004	TC Dish 92X17 Delta Sterile	400	11282.00	39269099
CLSCD005	TC Dish 92X17 Sterile	400	11282.00	39269099



Multidishes (Cell Culture Treated)

Designed to prevent cross contamination, Packed individually, Optically clear and uniform surface for microscopy Sterilized & Treated plates, Crystal – grade polystyrene (PS), Non – pyrogenic, Flat bottoms

Cat No.	Description	Pack	Unit Price	HSN
CLSMD001	6 Well Multidish W/Lid	75	10183.00	39269099
CLSMD002	6 Well Multidish W/Lid	85	16274.00	39269099
CLSMD003	8 Well Dish Ion Sterile Lid	100	68456.00	39269099
CLSMD004	12 Well Multidish W/Lid TC Treated	75	11232.00	39269099
CLSMD005	24 Well Multidish W/Lid TC Treated	75	12156.00	39269099
CLSMD006	24 Well Multidish W/Lid TC Treated	85	18170.00	39269099
CLSMD007	48 Well Multidish W/Lid TC Treated	75	20592.00	39269099
CLSMD008	48 Well Multidish W/Lid	85	22776.00	39269099
CLSMD009	96 Well Multidish W/Lid TC Treated	50	22776.00	39269099
CLSMD010	06 Well Multidish PS/Lid Non Treated	100	13451.00	39269099
CLSMD011	12 Well Multidish PS/Lid Non Treated	100	16758.00	39269099
CLSMD012	24 Well Multidish PS/Lid Non Treated	100	14333.00	39269099
CLSMD013	48 Well Multidish PS/Lid Non Treated	75	18462.00	39269099
CLSMD014	96 Well Multidish PS/Lid Non Treated	108	22157.00	39269099

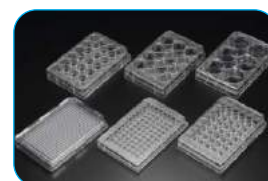

Cell Scrapper

Cell Scrapers are specially designed to facilitate collection attached cells on culture dish. Sterilization by irradiation and individual packing eliminate possible chances of contamination during cell culture and scraper handling. Rotatable blades, Sterilized, Non – pyrogenic, Non – cytotoxic

Cat No.	Description	Pack	Unit Price	HSN
CLSCS001	CELL SCRAPER, 23CM, SMALL	250	62773.00	39269099
CLSCS002	CELL SCRAPER, 32CM, LARGE	250	70736.00	39269099



Serological Pipetes

Serological Pipettes are classified by sample volume. Ascending & descending scales facilitate reading both dispensing and remaining volume.

Cat No.	Description	Pack	Unit Price	HSN
CLSSP001	1mL Pipette Individually Wrapped Paper/Plastic	1000	14741.00	39269099
CLSSP002	2mL Pipette Individually Wrapped Paper/Plastic	500	6823.00	39269099
CLSSP003	5mL Pipette Individually Wrapped Paper/Plastic	200	4086.00	39269099
CLSSP004	10mL Pipette Individually Wrapped Paper/Plastic	200	4837.00	39269099
CLSSP005	25mL Pipette Individually Wrapped Paper/Plastic	200	10362.00	39269099
CLSSP006	50mL Pipette Individually Wrapped Paper/Plastic	100	12487.00	39269099
CLSSP007	1mL Pipette Individually Wrapped Plastic	1000	12245.00	39269099
CLSSP008	2mL Pipette Individually Wrapped Plastic	500	7550.00	39269099
CLSSP009	5mL Pipette Individually Wrapped Plastic	200	3653.00	39269099
CLSSP010	10mL Pipette Individually Wrapped Plastic	200	4531.00	39269099
CLSSP011	25mL Pipette Individually Wrappd Plastic	200	9535.00	39269099
CLSSP012	50mL Pipette Individually Wrappd Plastic	100	14551.00	39269099
CLSSP013	1mL Serological Pipette, Bulk Packed	1000	14863.00	39269099
CLSSP014	2mL Serological Pipette, Bulk Packed	500	6614.00	39269099
CLSSP015	5mL Serological Pipette, Bulk Packed	500	11320.00	39269099
CLSSP016	10 mL Serological Pipette, Bulk Packed	500	14389.00	39269099
CLSSP017	25 mL Serological Pipette, Bulk Packed	200	11681.00	39269099
CLSSP018	50mL Serological Pipette, Bulk Packed	100	11878.00	39269099

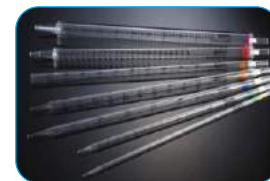

Cell Strainer

Cell Strainers are ideal for obtaining uniform single cell suspension from various sources. Cell Strainers are made from nylon with 3 different mesh sizes, showing optimal performances in a variety of applications such as stem cell, primary cell preparation.

Cat No.	Description	Pack	Unit Price	HSN
CLSCS50	CELL STRAINER, 40 UM, (Ind)	50	9812.00	39269099
CLSCS70	CELL STRAINER, 70 UM, (Ind)	50	9812.00	39269099
CLSCS100	CELL STRAINER, 100 UM, (Ind)	50	9812.00	39269099



Erlenmeyer Flask

The flasks are individually wrapped in an easy-to-tear, sterile bag, certified to be free of particulate matter, pyrogens, and nucleases (DNase/RNase). These flasks are ideal for all suspension cell cultures including baculovirus cultures, microbial cultures, algae cultures, media preparation, storage, and all related applications. They fit all standard shaking incubator systems and can be placed on any platform.

Cat No.	Description	Pack	Unit Price	HSN
CLSEF125	FLASK, 125ml, 26MM, VC,PC,S,IND	50	9812.00	39269099
CLSEF250	FLASK, 250ml, 31MM, VC,PC,S,IND	50	24024.00	39269099
CLSEF500	FLASK, 500ml, 43MM, VC,PC,S,IND	25	21336.00	39269099
CLSEF1000	FLASK, 1000ml, 43MM, W/VENT,CAO,IND	25	29222.00	39269099



Immunoplate (Elisa Plate)

Microplates for diagnostics and immunological researches. We provide researchers with a variety of microplates dedicated to immunoassays.

Cat No.	Description	Pack	Unit Price	HSN
CLSEP96N	Elisa Plate 96 Well. Flat Bottom, PS, Nonsterile 96 Well	60	7480.00	39269099
CLSEP96S	Elisa Plate 96 Well. Flat Bottom, PS, Sterile 96 Well	60	8794.00	39269099



For more information

+91-120-4968617

For more information

www.compositelabline.com

Vacuum Filtration Units Disposable

The units contain a high quality membrane and combine highest flow-rates and throughput with extremely low protein binding and extractables. They are therefore the product of choice for filtration of tissue culture media, buffers, additives and other aqueous biologicals. They offer improved filtration speed and throughput and are therefore ideally serving the requirement of cost effective filtration.

Low protein binding, Fast flow and high throughput, Easy to use, Engraved graduation.
 Ergonomically designed sidewalls and collar can simplify tightening / loosening and adjustments
 Designed hose connector can fit multiplicate hose diameters, Non-pyrogenic.
 Packaged in easy peel-to-open plastic bag, and receiver bottle cap is individually wrapped.
 Each individual unit is lot-numbered for easy identification and tracking.
 Sterilized through Gamma Radiation.



Technical Product Information

Material of Const.	Filter Upper Cup Capacity(mL)	Full Unit Overall Height	Filter Diameter (mm)	Working Volume (ml)	Hold-up Volume (mL)	Cap Material	Fitting Outlet (mm)	Maximum Operating Temp. (°C)
GPPS	150	156	50	150	3	PP	45	45
GPPS	250	200	50	250	3	PP	45	45
GPPS	500	245	75	500	3	PP	45	45
GPPS	1000	310	90	1000	3	PP	45	45

Cat Number	Funnel Capacity	Filter Pour Size(µm)	Membrane Material	Membrane Dia. (mm)	Per/case	Unit Price	HSN
CLSPE15075	150 ml	0.22	PES	75	12	7,800.00	84212900
CLSMC15090	150 ml	0.22	MCE	90	12	7,800.00	84212900
CLSPE15050	150 ml	0.45	PES	50	12	7,800.00	84212900
CLSPV25050	250 ml	0.22	PVDF	50	12	8,736.00	84212900
CLSPE25075	250 ml	0.22	PES	75	12	8,736.00	84212900
CLSPV25050	250 ml	0.45	PVDF	50	12	8,736.00	84212900
CLSPE25050	250 ml	0.45	PES	50	12	8,736.00	84212900
CLSPV50050	500 ml	0.22	PVDF	50	12	10,920.00	84212900
CLSPE50075	500 ml	0.22	PES	75	12	10,920.00	84212900
CLSPV50050	500 ml	0.45	PVDF	50	12	10,920.00	84212900
CLSPE50050	500 ml	0.45	PES	50	12	10,920.00	84212900
CLSPE1L75	1000 ml	0.22	PES	75	12	15,600.00	84212900



Bottle Top Filter

Cat No.	Product	Membrane	Pore size (µm)	Sterile	Packing	Price /pack	HSN
CLSPE22150	150ml bottle top filter	PES	0.22	GAMA	24 pcs.	10,649.00	84212900
CLSPV22250	250ml bottle top filter	PES	0.22	GAMA	24 pcs.	13,260.00	84212900
CLSPE22500	500ml bottle top filter	PES	0.22	GAMA	24 pcs.	14,976.00	84212900
CLSPE221L	1000ml bottle top filter	PES	0.22	GAMA	24 pcs.	19,968.00	84212900
CLSPE45150	150ml bottle top filter	PES	0.45	GAMA	24 pcs.	10,649.00	84212900
CLSPV45250	250ml bottle top filter	PES	0.45	GAMA	24 pcs.	13,260.00	84212900
CLSPE45500	500ml bottle top filter	PES	0.45	GAMA	24 pcs.	14,976.00	84212900
CLSPE451L	1000ml bottle top filter	PES	0.45	GAMA	24 pcs.	19,968.00	84212900
CLSMC22150	150ml bottle top filter	MCE	0.22	GAMA	24 pcs.	10,649.00	84212900
CLSMC22250	250ml bottle top filter	MCE	0.22	GAMA	24 pcs.	13,260.00	84212900
CLSMC22500	500ml bottle top filter	MCE	0.22	GAMA	24 pcs.	14,976.00	84212900
CLSMC221L	1000ml bottle top filter	MCE	0.22	GAMA	24 pcs.	19,968.00	84212900
CLSMC45150	150ml bottle top filter	MCE	0.45	GAMA	24 pcs.	13,260.00	84212900
CLSMC45250	250ml bottle top filter	MCE	0.45	GAMA	24 pcs.	13,260.00	84212900
CLSMC45500	500ml bottle top filter	MCE	0.45	GAMA	24 pcs.	14,976.00	84212900
CLSMC451L	1000ml bottle top filter	MCE	0.45	GAMA	24 pcs.	19,968.00	84212900
CLSPV22150	150ml bottle top filter	PVDF	0.22	GAMA	24 pcs.	10,649.00	84212900
CLSPV22250	250ml bottle top filter	PVDF	0.22	GAMA	24 pcs.	13,260.00	84212900
CLSPV22500	500ml bottle top filter	PVDF	0.22	GAMA	24 pcs.	14,976.00	84212900
CLSPV221L	1000ml bottle top filter	PVDF	0.22	GAMA	24 pcs.	19,968.00	84212900
CLSPV45150	150ml bottle top filter	PVDF	0.45	GAMA	24 pcs.	13,260.00	84212900
CLSPV45250	250ml bottle top filter	PVDF	0.45	GAMA	24 pcs.	13,260.00	84212900
CLSPV45500	500ml bottle top filter	PVDF	0.45	GAMA	24 pcs.	14,976.00	84212900
CLSPV451L	1000ml bottle top filter	PVDF	0.45	GAMA	24 pcs.	19,968.00	84212900



Beaker

Material: Polypropylene

Beakers, moulded in Polypropylene, have excellent clarity and very good chemical resistance. These autoclavable Beakers have prominently raised graduations on the outer surface. Pouring a solution becomes very convenient because of its tapered spout.

Cat No.	Description	Pack Size	Price / Pack	HSN CODE
CLS11101	50 ml	12	140.40	39269099
CLS11102	100 ml	12	159.12	39269099
CLS11104	250 ml	12	318.24	39269099
CLS11105	500 ml	12	486.72	39269099
CLS11106	1000 ml	4	274.56	39269099
CLS11107	2000 ml	4	542.88	39269099

Beaker Euro Design

Material: Polypropylene

Euro design Beakers, moulded in Polypropylene, too have excellent clarity and very good chemical resistance. These autoclavable Beakers also have prominently raised graduations on the outer surface. Its tapered spout is very helpful in conveniently pouring the solutions.

Cat No.	Description	Pack Size	Price / Pack	HSN CODE
CLS11110	25 ml	12	168.48	39269099
CLS11111	50 ml	12	177.84	39269099
CLS11112	100 ml	12	196.56	39269099
CLS11113	250 ml	12	318.24	39269099
CLS11114	500 ml	12	505.44	39269099
CLS11115	1000 ml	6	421.20	39269099
CLS11116	2000 ml	6	842.40	39269099
CLS11117	5000 ml	2	780.00	39269099

Beaker Printed

Material: Polypropylene

These beakers also moulded in polypropylenen have excellent clarity as well as very good chemical resistance. The prominent feature of these beakers is the easy to read printed graduations. These beakers being in PP are autoclavable.

Cat No.	Description	Pack Size	Price / Pack	HSN CODE
CLS11151	50 ml	12	262.08	39269099
CLS11152	100 ml	12	299.52	39269099
CLS11153	250 ml	12	505.44	39269099
CLS11154	500 ml	12	786.24	39269099
CLS11155	1000 ml	6	748.80	39269099
CLS11156	2000 ml	6	1310.40	39269099
CLS11157	5000 ml	2	936.00	39269099
CLS11158	10000 ml	2	1872.00	39269099

Burette

Material: Polymethyl Methacrylate/TPX

This Burette has a transparent acrylic pipe and a leak proof TPX stopcock fitted with a self lubricating PTFE plug. Each Burette is individually calibrated to give maximum accuracy. Acrylic body is unaffected by dilute mineral acids & bases except Hydrofluoric acide & Ammonium Hydroxide. The pH range of 1-14 is ideal and can be used up to 5%wt/wt of acids or 30% bases.

Cat No.	Description	Pack Size	Price / Pack	HSN CODE
CLS11501	25 ml	10	3276.00	39269099
CLS11502	50 ml	10	3666.00	39269099
CLS11503	100 ml	10	5928.00	39269099

Pipette Pump

Material: Acrylonitrile Butadiene Styrene

CLS presents a fast release pipetting device for precise pipetting & zip quick emptying. The knurled thumbwheel can be rotated to draw up or dispense liquids while the releaser may be pushed in for zip-quick emptying. The moulded chuck has silicon rubber collet inside to hold various pipettes of standard sizes. It resists acids & alkalies and can be easily disassembled for thorough cleaning

Cat No.	Description	Pack Size	Price / Pack	HSN CODE
CLS20001	2 ml	12	4305.60	39269099
CLS20002	10 ml	12	4305.60	39269099
CLS20003	25 ml	12	4867.20	39269099



Dropping Bottles

Material: Low Density Polyethylene

Blown in Low Density Polyethylene, Polylab Dropping Bottles dispense small uniform drops of liquids when pressed lightly.

Cat No.	Description	Pack Size	Price / Pack	HSN CODE
CLS22101	60 ml	12	252.72	39233090
CLS22102	125 ml	12	327.60	39233090

Dropping Bottles (Euro Design)

Material: Low Density Polyethylene

These bottles made in low density polyethylene dispense small uniform drops of liquids. The unique feature of these bottles is the screw cap with lid.

Cat No.	Description	Pack Size	Price / Pack	HSN CODE
CLS22201	15 ml	12	234.00	39233090
CLS22202	30 ml	12	271.44	39233090
CLS22203	60 ml	12	318.24	39233090
CLS22204	125 ml	12	374.40	39233090
CLS22205	250 ml	12	599.04	39233090

Reagent Bottles (Narrow Mouth)

Material: Polypropylene

These Narrow Mouth Reagent Bottles are available in polypropylene. The PP bottles are rigid, translucent and have excellent contact clarity. These bottles can be autoclaved filled as well as empty. The polypropylene Cap has a built in seal ring to make these bottles leakproof.

Cat No.	Description	Pack Size	Price / Pack	HSN CODE
CLS33251	4 ml	100	663.00	39233090
CLS33252	8 ml	100	819.00	39233090
CLS33253	15 ml	100	975.00	39233090
CLS33254	30 ml	12	168.48	39233090
CLS33301	60 ml	12	205.92	39233090
CLS33302	125 ml	12	280.80	39233090
CLS33303	250 ml	12	468.00	39233090
CLS33304	500 ml	12	580.32	39233090
CLS33305	1000 ml	6	561.60	39233090

Reagent Bottles (Wide Mouth)

Material: Polypropylene

These wide mouth reagent bottles are available in polypropylene. The PP bottles are rigid, translucent and have excellent contact clarity. These bottles can be autoclaved filled as well as empty. The polypropylene cap has a built in seal ring to make these bottles leakproof.

Cat No.	Description	Pack Size	Price / Pack	HSN CODE
CLS33311	30 ml	12	196.56	39233090
CLS33306	60 ml	12	224.64	39233090
CLS33307	125 ml	12	318.24	39233090
CLS33308	250 ml	12	542.88	39233090
CLS33309	500 ml	12	692.64	39233090
CLS33310	1000 ml	6	617.76	39233090

Narrow Mouth Bottles

Material: Polypropylene

This autoclavable bottle, made of polypropylene, can be used for storing & transferring chemicals and other reagents safe & sound.

Cat No.	Description	Pack Size	Price / Pack	HSN CODE
CLS33501	4000 ml	1	499.20	39233090



Wide Mouth Square Bottles

Material: Polypropylene

This autoclavable bottle, made of polypropylene, can be used for storing & shipping chemicals & reagents. Being wide mouthed, it is always convenient to pour in & take out the reagents. The built in depressions on two sides provide excellent grip while holding this bottle.

Cat No.	Discription	Pack Size	Price / Pack	HSN CODE
CLS33511	4000 ml	1	499.20	39233090



Havy Duty Vaccum Bottle

Material: Polypropylene

This autoclavable bottle, made of polypropylene, has thick walls, is rugged & can be used for repeated applications of vacuum.

Cat No.	Discription	Pack Size	Price / Pack	HSN CODE
CLS33521	2000 ml	1	374.40	39233090



Carboy

Carboys, made of polypropylene, are much lighter than glass. These autoclavable, dependable & durable carboys are provided with wide handles making it convenient while carrying or pouring purposes

Cat No.	Discription	Pack Size	Price / Pack	HSN CODE
CLS34001	10 ltrs.	1	1326.00	39233090
CLS34002	20 ltrs.	1	1934.40	39233090



Carboy with Stop Cock

These polypropylene Carboys are autoclavable, dependable & durable. These are also equipped with a leak proof spigot screwed to the body. These carboys are an excellent replacement for glass carboys and are used for storing & dispensing distilled water & other laboratory solutions.

Cat No.	Discription	Pack Size	Price / Pack	HSN CODE
CLS34051	10 ltrs.	1	1669.20	39233090
CLS34052	20 ltrs.	1	2371.20	39233090



Aspirator Bottle

Material: Polypropylene

Aspirator Bottles are made of polypropylene and are therefore much lighter than glass. These are autoclavable, dependable & durable. The leakproof spigot screwed to the bottle body requires only a half turn to open or close. These bottles are used for storing or dispensing distilled water & other laboratory solutions. Threads should be totally disengaged before autoclaving.

Cat No.	Discription	Pack Size	Price / Pack	HSN CODE
CLS34100	2 ltrs.	1	717.60	39233090
CLS34101	5 ltrs.	1	936.00	39233090
CLS34102	10 ltrs.	1	1669.20	39233090
CLS34103	20 ltrs.	1	2371.20	39233090



Wash Bottle

Material: Low Density Polyethylene

Wash Bottles are made of low density polyethylene which gives these bottles a translucent & unbreakable character. Solutions can be poured easily by squeezing the bottle lightly. The cap is fitted with a flexible polyethylene delivery tube which can be aimed wherever required.

Cat No.	Discription	Pack Size	Price / Pack	HSN CODE
CLS36601	125 ml	12	336.96	39233090
CLS36602	250 ml	12	486.72	39233090
CLS36603	500 ml	6	327.60	39233090
CLS36604	1000 ml	6	561.60	39233090



Wash Bottle (New Type)

Material: Low Density Polyethylene

These bottles are also made of low density polyethylene and are therefore translucent & unbreakable. The distinguishing feature that these bottles contain is the built in delivery tube making it a one-piece wash bottle. These bottles are graduated on the outer surface to give an approximate idea about the volume of solutions filled or dispensed.

Cat No.	Discription	Pack Size	Price / Pack	HSN CODE
CLS36605	250 ml	12	823.68	39233090
CLS36606	500 ml	12	973.44	39233090
CLS36607	125 ml	12	505.44	39233090

Conical Flask

Material: Polypropylene

Made of Polypropylene, these cone shaped flasks are rigid, translucent & autoclavable. The screw cap keeps the contents of the flask contamination free and makes the flask leakproof. Threads should be disengaged before autoclaving.

Cat No.	Discription	Pack Size	Price / Pack	HSN CODE
CLS38101	100 ml	12	673.92	39233090
CLS38102	250 ml	12	992.16	39233090
CLS38103	500 ml	12	1572.48	39233090

Specimen Jar

Material: Polystyrene

These transparent specimen jars, used for preserving different specimens in the lab are provided with a cap that fits in tight. These jars provided excellent protection to the species preserved in it.

Cat No.	Discription	Pack Size	Price / Pack	HSN CODE
CLS40001	Gas Jar	12	730.08	39231090

Fisher Clamp

Material: Polypropylene

These Clamps are moulded in Polypropylene making it completely corrosion-proof. The spring loaded jack in the middle provides a vice like grip to the burette and prevents it from slipping. Two tapered wedges are provided to ensure firm grip on rods having dia 1/2" or 3/8".

Cat No.	Discription	Pack Size	Price / Pack	HSN CODE
CLS45101	Single	12	842.40	39269099
CLS45102	Double	6	842.40	39269099

Funnel Holder

Material: Polypropylene

Made of Polypropylene, these corrosion free funnel holders can hold funnels with dia 3" to 6". The extra plate provided can be placed to hold funnels bearing dia 1" to 3". Two tapered wedges are provided to ensure firm grip on rods having dia 1/2" or 3/8".

Cat No.	Discription	Pack Size	Price / Pack	HSN CODE
CLS45103	Single	12	936.00	39269099
CLS45106	Double	6	936.00	39269099

Speratory Funnel Holder

Material: Polypropylene

This non-corrosive seperatory funnel holder, moulded in polypropylene, has a front opening which provides clear view of the solution and allows unobstructed placement of separatory funnels. Two tapered wedges are provided to ensure firm grip on rods having dia 1/2" or 3/8".

Cat No.	Discription	Pack Size	Price / Pack	HSN CODE
CLS45104	Seperatory Funnel Holder	12	1123.20	39269099



Flask Stand

Material: Polypropylene

Moulded in Polypropylene, this flask stand gives a stair-like top view. Every step provides excellent support to the round bottom flask at every point of contact. This flask stand can hold round bottom flasks up to 10 Ltr. Capacity. This stackable flask stand can also be steam autoclaved.

Cat No.	Description	Pack Size	Price / Pack	HSN CODE
CLS45105	Flask Stand	6	889.20	39269099

Connector (T&Y)

Material: Polypropylene

These connectors add to the existing range of connectors. The crest & valley structure provided at all the ends of the connectors give excellent leakproof grip to the tube.

Cat No.	Description	Pack Size	Price / Pack	HSN CODE
CLS46111	T-Connector 6 mm	36	336.96	39269099
CLS46112	Y-Connector 6 mm	36	336.96	39269099
CLS46113	T-Connector 8 mm	36	449.28	39269099
CLS46114	Y-Connector 8 mm	36	449.28	39269099
CLS46115	T-Connector 10 mm	36	617.76	39269099
CLS46116	Y-Connector 10 mm	36	617.76	39269099

Connector (Cross)

Material: Polypropylene

These four way connectors prove to be an excellent option for achieving leak proof joints in tubing connections.

Cat No.	Description	Pack Size	Price / Pack	HSN CODE
CLS46121	Cross Connector-6 mm	36	449.28	39269099
CLS46122	Cross Connector-8 mm	36	561.60	39269099
CLS46123	Cross Connector-10 mm	36	673.92	39269099

Connector (L Shaped)

Material: Polystyrene

These L Shaped Connectors also add to the range of different connectors committed to provide excellent leakproof tube arrangements.

Cat No.	Description	Pack Size	Price / Pack	HSN CODE
CLS46131	L Connector-6 mm	36	252.72	39269099
CLS46132	L Connector-8 mm	36	393.12	39269099
CLS46133	L Connector-10 mm	36	561.60	39269099

Animal Cage

Material: Polypropylene/Stainless Steel

Available in two different sizes, these Cages provide excellent shelter for different animal species in the laboratory. The metallic top provides proper ventilation and has provisions for feeding the species

Cat No.	Description	Pack Size	Price / Pack	HSN CODE
CLS47001	290 x 220 x 140 mm	1	982.80	39269099
CLS47002	430 x 270 x 150 mm	1	1404.00	39269099

Water Bottle

Material: Polypropylene/Stainless Steel

These water bottles prove to be an excellent accessory for the species kept in the cages.

Cat No.	Description	Pack Size	Price / Pack	HSN CODE
CLS47003	125 ml	12	1235.52	39233090
CLS47004	250 ml	12	1778.40	39233090



Animal Cage (Twin Grill)

Material: Polypropylene/Stainless Steel

Adding in line with the existing range, these animal cages are provided with a stainless steel grill at the bottom of the cage to provide a clean surface for the species to move on.

Cat No.	Description	Pack Size	Price / Pack	HSN CODE
CLS48001	290 x 220 x 140 mm	1	1341.60	39269099
CLS48002	430 x 270 x 150 mm	1	1840.80	39269099



Retort Stand

Material: Polystyrene/Polypropylene

These non-corrosive, moulded retort stands provide excellent replacement for the metal ones. Even the metallic rod has a polypropylene covering making it non-corrosive. The rod measuring 12.5 mm X 750 mm can be screwed into the heavy base giving way to a perfectly stable retort stand

Cat No.	Description	Pack Size	Price / Pack	HSN CODE
CLS54101	225 x 150 mm-Side Hole	1	530.40	39269099
CLS54102	300 x 200 mm-Centre Hole	1	873.60	39269099
CLS54103	300 x 200 mm-Side Hole	1	873.60	39269099



Desiccator (Vaccum)

Material: Polypropylene/Polycarbonate

These autoclable vaccum desiccators can hold vaccum upto 740 mm of Hg for 24 hrs without any greasing. The top dome, moulded in rigid and transparent polycarbonate, gives a crystal clear view of the desiccant placed inside. The knurled knob on the top provides easy handling of the dome. The lower part is made of polypropylene. An internal groove is provided on the flange to hold a silicon rubber O-Ring. The polypropylene stopcock is fitted with a self lubricating PTFE plug. This plug works three way i.e. vaccum creation, shutting off & vaccum releasing.

Cat No.	Description	Pack Size	Price / Pack	HSN CODE
CLS55204	PP/PC 150 mm	1	1872.00	39269099
CLS55205	PP/PC 200 mm	1	2886.00	39269099
CLS55206	PP/PC 250 mm	1	3588.00	39269099
CLS55207	PP/PC 300 mm	1	5538.00	39269099



Desiccator (Vaccum) All Clear

Material: Polypropylene/Polycarbonate

These Vaccum Desiccators are provided with a transparent polycarbonate bottom that makes it more robust and provides excellent view of the desiccator. All the other features are same as PP/PC vaccum desiccators

Cat No.	Description	Pack Size	Price / Pack	HSN CODE
CLS55214	PP/PC 150 mm	1	2184.00	39269099
CLS55215	PP/PC 200 mm	1	3510.00	39269099
CLS55216	PP/PC 250 mm	1	4446.00	39269099
CLS55217	PP/PC 300 mm	1	6708.00	39269099



Desiccator (Plain)

Material: Polypropylene/Polycarbonate

Plain Desiccators are physically the same as Vaccum desiccators. Only difference is the absence of stop cock. Grease should be applied on the flanges to make it air tight. Both Vaccum & Plan Desiccators are provided with a thick perforated Polypropylene disc with a big hole in the centre for easy lifting. The tiny holes in the disc provide air troughs & support to the dishes. However porcelain discs are advisable in case of incandescent crucibles.

Cat No.	Description	Pack Size	Price / Pack	HSN CODE
CLS55201	PP/PC 150 mm	1	1154.40	39269099
CLS55202	PP/PC 200 mm	1	2106.00	39269099
CLS55203	PP/PC 250 mm	1	2808.00	39269099
CLS55208	PP/PC 300 mm	1	4680.00	39269099



Stop Cocks

Material: Polypropylene/PTFE

These polypropylene Stop Cocks are fitted with a PTFE plug & have serrated tubulations that accept from 6 mm to 10 mm tubing. These Stop Cocks are absolutely leakproof and are available in two different options i.e. 2 way & 3 way.

Cat No.	Description	Pack Size	Price / Pack	HSN CODE
CLS55301	2 Way	6	2152.80	39269099
CLS55302	3 Way	6	2433.60	39269099



Kipp's Apparatus

Material: High Density Polyethylene

Kipp's Apparatus made of polyethylene has three main portions. The top portion is fitted with a thistle funnel and a bulb structure through which dilute acid can be poured which reacts with a metal sulphide in the base of the apparatus. H₂S gas then evolved collects in the middle dome from where it can be released through a leakproof stopcock fitted with a self lubricating PTEE plug. The base is provided with a residual outlet fitted with a cap for easy cleaning.

Cat No.	Discription	Pack Size	Price / Pack	HSN CODE
CLS55501	250 ml	1	936.00	39269099
CLS55502	500 ml	1	1092.00	39269099
CLS55503	1000 ml	1	1326.00	39269099



Funnels-Long Stem

Material: Polypropylene

These long stem funnels have smooth walls, 60° cone angle and external ribs to prevent air lock. Moulded in polypropylene, these clear funnels can also be steam autoclaved.

Cat No.	Discription	Pack Size	Price / Pack	HSN CODE
CLS57104	100 mm	36	758.16	39269099
CLS57107	150 mm	12	842.40	39269099



Buchner Funnel

Material: Polypropylene

Moulded in Polypropylene, these two piece funnels are light weight, easy to clean & autoclavable. The top portion can be snap fitted with the lower one forming a vacuum seal which does not require greasing. The base of the top portion has perforated filter plate.

Cat No.	Discription	Pack Size	Price / Pack	HSN CODE
CLS57105	70 mm	12	1347.84	39269099
CLS57106	110 mm	6	936.00	39269099
CLS57108	90 mm	12	1684.80	39269099



Analytical Funnel

Material: Polypropylene

Designed specifically for analytical chemistry, the body of the funnels is 60°. Moulded in PP, these funnels are provided with internal & external ribs to prevent air blockage.

Cat No.	Discription	Pack Size	Price / Pack	HSN CODE
CLS57199	35 mm	72	449.28	39269099
CLS57200	50 mm	72	505.44	39269099
CLS57201	62 mm	36	421.20	39269099
CLS57202	75 mm	36	421.20	39269099
CLS57202	100 mm	36	898.56	39269099



Powder Funnel

Material: Polypropylene

These polypropylene funnels are best suited for transferring powdered reagents. The unique feature of these funnels is its parallel stem that minimizes bridging of powder. These funnels are steam autoclavable at 121°C.

Cat No.	Discription	Pack Size	Price / Pack	HSN CODE
CLS57221	65 mm	36	505.44	39269099
CLS57222	80 mm	36	617.76	39269099
CLS57223	100 mm	36	1235.52	39269099
CLS57224	150 mm	12	842.40	39269099



Industrial Funnel

Material: Polypropylene

Industrial funnels are designed in such a way that they make filling of carboys, drums and barrels very convenient. The handles of these funnels make their handling very easy.

Cat No.	Discription	Pack Size	Price / Pack	HSN CODE
CLS57231	200 mm	12	2059.20	39269099
CLS57232	250 mm	6	2574.00	39269099



Petri Dish

Material: Polypropylene

These Polypropylene Petri Dishes are clear, unbreakable & autoclavable.

Cat No.	Discription	Pack Size	Price / Pack	HSN CODE
CLS57301	50 mm	36	421.20	39233090
CLS57302	75 mm	36	561.60	39233090
CLS57303	100 mm	36	673.92	39233090
CLS57304	125 mm	12	673.92	39233090
CLS57305	150 mm	12	898.56	39233090

Petri Dish (Culture)

Material: Polystyrene

This PS Petri Dish with fitting proves excellent for culture experiments. Made in polystyrene, this transparent Petri Dish provides excellent inside view.

Cat No.	Discription	Pack Size	Price / Pack	HSN CODE
CLS57501	Petri Dish (Culture)	12	673.92	39233090

Atomic Model Set

Material: Polystyrene

These sets consist of moulded balls of different colours and sizes along with connecting lugs of different sizes. These sets are very helpful in modelling different organic & Inorganic compounds.

SENIOR SET : This set consists of 185 lugs & 370 balls of prescribed colours & sizes packed in a moulded box having separate space for every particular colour & size of ball.

JUNIOR SET : This set consists of 37 connecting lugs & 75 balls of different colours & sizes packed in a moulded box.

Cat No.	Discription	Pack Size	Price / Pack	HSN CODE
CLS58001	Senior Set	1	3120.00	90230010
CLS58002	Junior Set	1	663.00	90230010

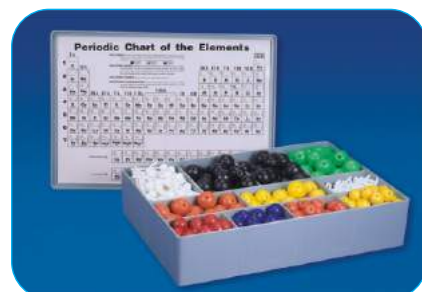
Atomic Model Set (Euro Design)

Material: Polystyrene

This set consists of moulded balls of different colours & sizes along with connectors of different sizes. The sizes & shapes of the balls & connecting lugs have been designed in accordance with internationally acceptable standards.

Cat No.	Discription	Pack Size	Price / Pack	HSN CODE
CLS58011	Student Set	1	1170.00	90230010
CLS58012	Teacher Set	1	1872.00	90230010

Crystal Model Set

Material: Polystyrene

These Crystal Model Sets contain different coloured jacks (Red, Black & White) and connectors (long & short) in a prescribed number to be joined together in an illustrated way to form structures like diamond, Graphite & Sodium Chloride.

Cat No.	Discription	Pack Size	Price / Pack	HSN CODE
CLS58101	Diamond	1	195.00	90230010
CLS58102	Sodium Chloride	1	195.00	90230010
CLS58103	Graphite	1	195.00	90230010

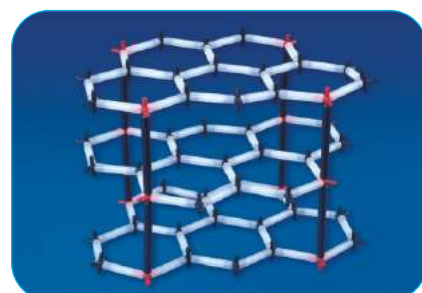
Coplin Jar

Material: Polypropylene

Coplin Jar made of Polypropylene, can hold 10 slides of the size 1"x3" back to back. The interior of the Coplin Jar is grooved in a way to hold slides in erect position. Domed & shallow thread screw cap provides protection to the slides.

Cat No.	Discription	Pack Size	Price / Pack	HSN CODE
CLS62101	Coplin Jar	12	449.28	39231090



Slide Mailer

Material: Polypropylene

Slide Mailers present the best option to carry prepared slides from one place to another. Moulded in Polypropylene, these slide mailers are available in four sizes i.e 1, 2, 5 and 10 slides.

Cat No.	Discription	Pack Size	Price / Pack	HSN CODE
CLS62100	1 Slide	25	234.00	39231090
CLS62102	2 Slides	25	390.00	39231090
CLS62103	5 Slides	25	390.00	39231090
CLS62111	10 Slides	25	585.00	39231090



Slide Box

Material: Polystyrene

These Slide Boxes are durable, compact & provide utmost protection to 1"X3" slides. Heavy walls will not warp, splinter or crack. Boxes are unaffected by humidity and are thoroughly insect proof. Base of the slide Box has a numbered index for easy slide Identification.

Cat No.	Discription	Pack Size	Price / Pack	HSN CODE
CLS62104	25 Slides	12	973.44	39231090
CLS62105	50 Slides	12	1872.00	39231090
CLS62106	100 Slides	6	1404.00	39231090



Slide Storage Rack

Material: Acrylonitrile Butadiene Styrene

Adding to the existing range of slide accessories, this slide storage rack made of ABS can hold 100 slides, recognizable through the numeric indexing. Spacing between the slots provides adequate backward & forward movement of slides for convenient recognition. The transparent cover provide excellent view of the slides stored inside.

Cat No.	Discription	Pack Size	Price / Pack	HSN CODE
CLS62501	100 Slides	6	3042.00	39231090



Float Rack

Material: Polypropylene

This float rack molded in polypropylene is quite compact, autoclavable and can hold 16 micro centrifuge tubes for incubation in water baths. Easy to load, these are essential in microbiology & immunology labs. The surface of the rack has raised alpha-numeric index for easy identification and has a central rod handle for convenient lifting.

Cat No.	Discription	Pack Size	Price / Pack	HSN CODE
CLS63201	Float Rack	12	1572.48	39269099



MCT Twin Rack

Material: Polypropylene

This twin purpose rack for both 0.5 ml. & 1.5 ml. micro centrifuge tubes. Each side has 108 holes for 0.5 & 1.5 ml. MCT's respectively. The transparent top provides an excellent view as well as a protection cover for the tubes stored. Each face of the base has a unique alpha-numeric index for easy identification of the tube.

Cat No.	Discription	Pack Size	Price / Pack	HSN CODE
CLS63211	0.5 ml & 1.5 ml MCTS	4	1934.40	39231090

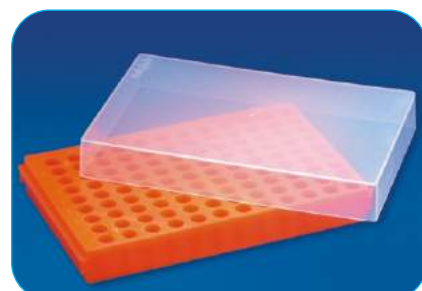

PCR Tube Rack

Material: Polycarbonate/Polypropylene

This rack, as the name suggests, is used for keeping PCR tubes. Top & base of this rack are made of tough & transparent polycarbonate while the middle portion is made of polypropylene. The tube holding spaces are uniformly placed so as to facilitate the use of multipipettes. A no. of racks can be stacked together to save shelf space.

Cat No.	Discription	Pack Size	Price / Pack	HSN CODE
CLS63212	96 PCR Tubes of 0.2 ml	4	1310.40	39231090

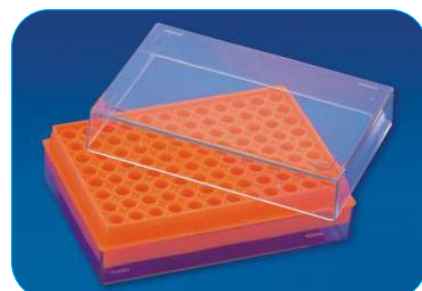

MCT Box

Material: Polycarbonate

MCT boxes are moulded in polycarbonate and are therefore strong as well as autoclavable. One size can hold 64 MCTs of 1.5 ml. & the other can hold 100 MCTs of 0.5 ml. These boxes are designed to work at temperatures ranging from - 190° C to +121° C. The transparent cover provides a good view of the contents inside & is numbered for better inventory control.

Cat No.	Discription	Pack Size	Price / Pack	HSN CODE
CLS63213	Rack for 100 MCTs of 0.5 ml	4	1622.40	39231090
CLS63214	Rack for 64 MCTs of 1.5 ml	4	1622.40	39231090



Centrifuge Tube Conical Bottom

Material: Polypropylene

CLS centrifuge tubes with conical bottom are available in two sizes i.e 15 ml. & 50 ml. Moulded in Polypropylene, these tubes are clear, strong & safe. These autoclavable tubes are provided with printed graduations on the outer surface. The built in seal ring in the cap makes these tubes absolutely leakproof. These tubes can withstand forces upto 7500xG & 12000xG for 15 ml. & 50 ml. tubes respectively.

Cat No.	Discription	Pack Size	Price / Pack	HSN CODE
CLS63301	15 ml	100	1404.00	39269099
CLS63302	50 ml	100	1560.00	39269099



Centrifuge Tube Box

Material: Polypropylene

Autoclavable centrifuge tube boxes can be used at temperatures of -90°C to 121°C. Racks hold 36 each 15ml tubes, or 16 each 50ml tubes, and feature a clear lid for easy identification of contents.

Cat No.	Discription	Pack Size	Price / Pack	HSN CODE
CLS63351	15 ml	4	1404.00	39231090
CLS63352	50 ml	4	1404.00	39231090

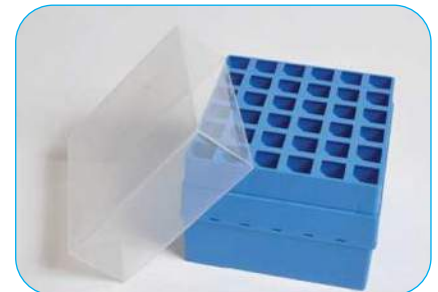

Centrifuge Tube Round Bottom

Material: Polypropylene/Polycarbonate

CLS centrifuge tubes with round bottom are moulded in polypropylene & polycarbonate. These tubes have excellent clarity and are strong enough to be used upto 50,000xG. These tubes can be autoclaved, however, repeated autoclaving in PC tubes reduces their mechanical strength.

Cat No.	Discription	Pack Size	Price / Pack	HSN CODE
CLS63401	16 ml (P.P)	50	858.00	39269099
CLS63402	50 ml (P.P)	50	1560.00	39269099
CLS63411	16 ml (P.C)	50	3120.00	39269099
CLS63412	50 ml (P.C)	50	5148.00	39269099



Cap For Centrifuge Tube Round Bottom

Material: Polypropylene/Polycarbonate

Cat No.	Discription	Pack Size	Price / Pack	HSN CODE
CLS63421	For 16 ml	100	468.00	39235010
CLS63422	For 50 ml	100	702.00	39235010

Oak Ridge Centrifuge Tubes

Material: Polypropylene

Oak ridge centrifuge tubes, made of polypropylene, have excellent contact clarity and can be used upto 50,000xG. The screw cap is fitted with silicon O-ring making it totally leakproof. These tubes should not be used below 4°C.

Cat No.	Discription	Pack Size	Price / Pack	HSN CODE
CLS63501	30 ml	12	505.44	39269099
CLS63502	50 ml	12	711.36	39269099
CLS63503	100 ml	12	1347.84	39269099



Urin Container

Material: Polypropylene

These containers can be used for collecting a wide range of samples of sputum, urine etc. Moulded in polypropylene these containers have excellent contact clarity and the cap has built-in seal that makes it completely leakproof.

Cat No.	Discription	Pack Size	Price / Pack	HSN CODE
CLS63701	30 ml	100	975.00	39233090
CLS63702	60 ml	100	975.00	39233090



Stool Container

Material: Polypropylene

These containers, as the name suggest, are used for collecting stool samples. The cap is provided with a spoon like structure that proves helpful in lifting samples.

Cat No.	Discription	Pack Size	Price / Pack	HSN CODE
CLS63801	30 ml	100	1053.00	39233090
CLS63802	60 ml	100	1053.00	39233090
CLS63901	25 ml	100	702.00	39233090



Ria Vail

Material: Polypropylene/Polystyrene

These polypropylene/polystyrene tubes are generally used in RIA, Coagulation & bacteriology. The polypropylene tubes are clear and can withstand 3000 RCF during centrifugation while the transparent polystyrene tubes can withstand 1400 RCF. The PP tubes can accept common acids, alkalis & solvents at room temperature while the PS tubes can accept mild bases, weak acids but not organic solvents.

Cat No.	Discription	Pack Size	Price / Pack	HSN CODE
CLS64001	12 x 75 mm / PS	500	858.00	39269099
CLS64002	12 x 75 mm / PP	500	819.00	39269099
CLS64011	Cap For 12 mm RIA Tube	100	70.20	39235010



Test Tube with Screw Cap

Material: Polypropylene/Polystyrene

These polypropylene tubes provide excellent option for RIA, coagulation & bacteriology etc. The cap in screwed on to the tube & hence this tube can be filled up to the brim.

Cat No.	Discription	Pack Size	Price / Pack	HSN CODE
CLS64016	16 x 100 mm	500	3510.00	39269099



Test Tube Cap

Material: Polypropylene

This transparent polypropylene cap for Test Tubes proves to be an excellent protection to the contents to the tubes. The grooves inside the cap tighten the fitting on the tube while the outer grooves would hold identification labels. The built in seal ring would set in the tube making the combination a leakproof one.

Cat No.	Discription	Pack Size	Price / Pack	HSN CODE
CLS64021	Ø 25 mm	100	273.00	39235010



Storage Vail

Material: Polypropylene

As the name suggests, these vials are commonly used for storage of biological material, human & animal cells. The Cap is provided with a built in seal ring making the vial leakproof. The base of the vial has longitudinal grooves which give it a non-twisting character when placed in a vial rack.

Cat No.	Discription	Pack Size	Price / Pack	HSN CODE
CLS64102	2.0 ml	500	1638.00	39233090
CLS64103	5.0 ml	500	3588.00	39233090



SV10-SV5

Material: Polypropylene

These polypropylene vials add to the existing range of Polylab storage vials. Available in 5 ml. & 10 ml. capacities, these vials have polypropylene cap with built in seal ring making it a leak proof vial. Just like others storage vials these vials are also used for the storage of biological material, animal & human cells etc.

Cat No.	Discription	Pack Size	Price / Pack	HSN CODE
CLS64201	SV - 10 ml	500	3900.00	39233090
CLS64202	SV - 5 ml	500	2184.00	39233090



Scintillation vial

Material: High Density Polyethylene

These unbreakable vials, moulded in Polyethylene, are fitted with leakproof screw caps. These vials can be used with standard counting equipment for liquid scintillation system and are excellent for low activity count.

Cat No.	Description	Pack Size	Price / Pack	HSN CODE
CLS65001	8 ml	100	663.00	39233090
CLS65002	20 ml	100	904.80	39233090



Rack for Scintillation Vial

Material: Polypropylene

These Racks for scintillation Vials, moulded in Polypropylene, are autoclavable & corrosion resistant. There is an individual rack for both 8 ml. & 20 ml. vials. These rugged & stable racks can hold scintillation vials for convenient storage, handling & sample preparations.

Cat No.	Description	Pack Size	Price / Pack	HSN CODE
CLS65101	Rack For 90 Vials of 8 ml	2	1029.60	39269099
CLS65102	Rack For 50 Vials of 20 ml	2	1029.60	39269099



Cryo Vial

Material: Polypropylene

Cryo vials are normally used for storage of biological material, human & animal cells. These sterilized tubes are provided with white, prominent graduations and a long marking area for sample identification. The cap of these vials is provided with a seal ring inside to make it completely leakproof. The longitudinal grooves in the base give a non twisting feature to these vials when placed in a cryo rack.

Cat No.	Description	Pack Size	Price / Pack	HSN CODE
CLS66002	1.8 ml	1000	5148.00	39233090
CLS66003	4.5 ml	500	4485.00	39233090



Cryo Coders

Material: Polystyrene

These Coders available in different colours can easily fit into the cap of cryo vials for colour identification of different samples.

Cat No.	Description	Pack Size	Price / Pack	HSN CODE
CLS66101	Cryo Coders	100	187.20	39269099



Cryo Rack

Material: Polycarbonate

CLS Cryo Rack is moulded in polycarbonate making it tough, durable & autoclavable. This handy rack can hold 50 vials at a time. The unique feature of this rack is that vials can be unscrewed without actually picking them up as the vial will lock in every well and hence will not twist. This rack is provided with four anti skid rubbers & each well is identified with an alpha-numeric index.

Cat No.	Description	Pack Size	Price / Pack	HSN CODE
CLS66201	Cryo Rack	2	1014.00	39269099



Cryo Vials Box (PC)

Material: Polycarbonate

Cryo Boxes are moulded in polycarbonate making it extra strong and autoclavable. These can accommodate Cryo Vials of up to 4.5 ml. capacity and are designed to be used at temperatures ranging from -190°C to 121°C. The transparent cover of the box gives a good view of the contents inside and is numbered for better inventory control

Cat No.	Description	Pack Size	Price / Pack	HSN CODE
CLS66300	50 places for 1 ml or 1.8 ml	8	1747.20	39231090
CLS66301	81 places for 1 ml or 1.8 ml	4	1372.80	39231090
CLS66302	81 places for 4.5 ml	4	1872.00	39231090
CLS66303	100 places for 1 ml or 1.8 ml	4	1560.00	39231090

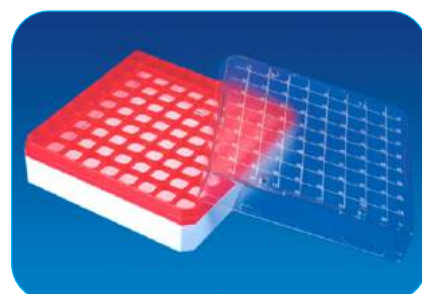

Cryo Vials Box (PP)

Material: Polypropylene

Moulded in polypropylene, the top of the box is attached to the bottom through well designed built-in hinges. The bottom has built-in spaces to hold vials up to 2ml capacity. Available in two different sizes, these autoclavable boxes bear alpha numeric index for easy identification of different vials placed inside.

Cat No.	Discription	Pack Size	Price / Pack	HSN CODE
CLS66501	81 places for 1 ml or 1.8 ml	4	873.60	39231090
CLS66502	100 places for 1 ml or 1.8 ml	4	1092.00	39231090

Micro Test Plate

Material: Polystyrene

CLS micro test plates are made of optically clear, non-toxic Polystyrene. These plates with 96 U Bottom or flat bottom wells bear alpha-numeric index. Uniform placement of all the wells facilitate use of multi channel pipettes.

Cat No.	Discription	Pack Size	Price / Pack	HSN CODE
CLS66801	Flat Bottom	72	3201.12	39269099
CLS66802	U Bottom	72	3201.12	39269099

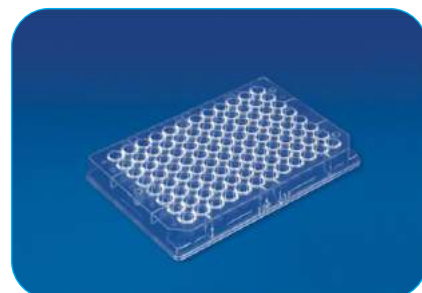
Micro Tip Box (New)

Material: Polypropylene

The unique feature of these tip boxes is the improved robust hinge design which prevents the top from being easily disengaged from the bottom of the box.

Cat No.	Discription	Pack Size	Price / Pack	HSN CODE
CLS67011	96 Micro Tips of 2-10µl	6	748.80	39231090
CLS67012	96 Micro Tips of 2-200µl	6	748.80	39231090
CLS67013	96 Micro Tips of 200-1000µl	6	982.80	39231090

Volumetric Flask

Material: Polypropylene

CLS Volumetric Flasks, blown in Polypropylene, are strong, unbreakable and have a good contact clarity. These autoclavable flasks are provided with screw caps to prevent leakage

Cat No.	Discription	Pack Size	Price / Pack	HSN CODE
CLS68001	25 ml	6	421.20	39233090
CLS68002	50 ml	6	589.68	39233090
CLS68003	100 ml	6	711.36	39233090
CLS68004	250 ml	3	439.92	39233090
CLS68005	500 ml	3	617.76	39233090
CLS68006	1000 ml	2	624.00	39233090

Rack For Petri Dish

Material: Polystyrene

These transparent, ready to use, disposable Petri Dishes are made of optically clear, non-toxic, Polystyrene. These Petri Dishes packed individually in polyethylene bags are sterilized by radiation.

Cat No.	Discription	Pack Size	Price / Pack	HSN CODE
CLS69101	For 90 mm	2	3120.00	39269099
CLS69102	For 60 mm	2	2808.00	39269099

Universal Multi Rack

Material: Polypropylene

This rack is an excellent lab apparatus compatible with different sizes of tubes. Four sides of this rack can be used for tubes of Ø30mm, Ø20mm, Ø17mm & Ø12mm.

Cat No.	Discription	Pack Size	Price / Pack	HSN CODE
CLS76001	Universal Multi Rack	6	3042.00	39269099
CLS76002	Rotatable Multi Rack	1	1560.00	39269099



Nestler Cylinder Stand

Material: Polypropylene

This stand, as the name suggests, is used for keeping nestler cylinders. Made of polypropylene, this stand is available in two sizes, one for 50ml nestler cylinder & other for 100ml. nestler cylinder.

Cat No.	Description	Pack Size	Price / Pack	HSN CODE
CLS76101	50 ml	6	1310.40	39269099
CLS76102	100 ml	6	1310.40	39269099

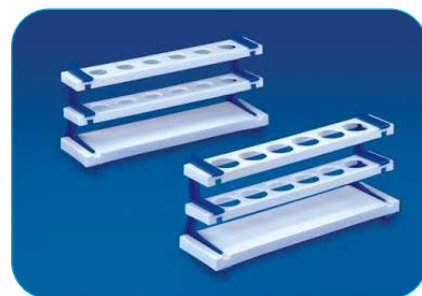
Test Tube Stand

Material: Polypropylene

This autoclavable stand is perhaps the most commonly used test tube stand in various laboratories. For better visibility, this 6 place rack is end supported by 2 columns. The top plate has 2 holes for holding 25 mm dia test tubes, four holes to hold 16 mm dia tubes where as the base has corresponding hemispherical wells. It also has six vertical pins for drying tubes. Another option available in this section is a test tube stand in which all the holes in the top plates can hold 25 mm dia tubes.

Cat No.	Description	Pack Size	Price / Pack	HSN CODE
CLS77702	25 mm Ø Tubes	12	786.24	39269099

Test Tube Stand (Round)

Material: Polypropylene

A handy, little, space saver, this circular twelve place polypropylene test tube stand has four 25 mm dia holes & eight 19 mm dia holes in its top plate. The base has matching hemispherical wells & 16 vertical pins for drying tubes surrounded by a trough to catch drippings. This autoclavable rack can be easily disassembled for cleaning purpose.

Cat No.	Description	Pack Size	Price / Pack	HSN CODE
CLS77704	19 mm & 25 mm Ø Tubes	2	343.20	39269099

Rack For Micro Centrifuge Tube

Material: Polypropylene

A handy, little, space saver, this circular twelve place polypropylene test tube stand has four 25 mm dia holes & eight 19 mm dia holes in its top plate. The base has matching hemispherical wells & 16 vertical pins for drying tubes surrounded by a trough to catch drippings. This autoclavable rack can be easily disassembled for cleaning purpose.

Cat No.	Description	Pack Size	Price / Pack	HSN CODE
CLS77705	24 Tubes	4	1060.80	39269099
CLS77705A	48 Tubes	4	2121.60	39269099

Test Tube Stand (3 Tier) - PP

Material: Polypropylene

These ingenious racks with a 3-tier design provide clear view of the tube contents & convenient insertion & removal of tubes. The PC Rack has transparent upper & middle plates where as in PP racks, every part is colored & opaque. These autoclavable racks can withstand sub-freezing temperatures.

Cat No.	Description	Pack Size	Price / Pack	HSN CODE
CLS77706	13 mm x 31 Tubes	2	296.40	39269099
CLS77707	16 mm x 31 Tubes	2	296.40	39269099
CLS77708	20 mm x 20 Tubes	2	421.20	39269099
CLS77709	25 mm x 12 Tubes	2	296.40	39269099
CLS77710	25 mm x 18 Tubes	2	421.20	39269099
CLS77711	32 mm x 12 Tubes	2	499.20	39269099
CLS77712	25 mm x 36 Tubes	2	842.40	39269099
CLS77714	13 mm x 18 Tubes	4	374.40	39269099
CLS77715	15 mm x 18 Tubes	4	374.40	39269099
CLS77716	18 mm x 12 Tubes	4	374.40	39269099
CLS77717	13 mm x 62 Tubes	2	592.80	39269099
CLS77718	16 mm x 62 Tubes	2	592.80	39269099
CLS77719	20 mm x 40 Tubes	2	842.40	39269099
CLS77720	13 mm x 48 Tubes	2	436.80	39269099
CLS77721	13 mm x 72 Tubes	2	499.20	39269099



Test Tube Stand (3 Tier) - PC

Material: Polycarbonate

These ingenious racks with a 3-tier design provide clear view of the tube contents & convenient insertion & removal of tubes. The PC Rack has transparent upper & middle plates where as in PP racks, every part is colored & opaque. These autoclavable racks can withstand sub-freezing temperatures.

Cat No.	Discription	Pack Size	Price / Pack	HSN CODE
CLS77801	13 mm x 31 Tubes	2	717.60	39269099
CLS77802	16 mm x 31 Tubes	2	717.60	39269099
CLS77803	20 mm x 20 Tubes	2	904.80	39269099
CLS77804	25 mm x 12 Tubes	2	717.60	39269099
CLS77805	13 mm x 62 Tubes	2	1435.20	39269099
CLS77806	16 mm x 62 Tubes	2	1435.20	39269099
CLS77807	20 mm x 40 Tubes	2	1809.60	39269099
CLS77808	25 mm x 24 Tubes	2	1435.20	39269099
CLS77809	25 mm x 18 Tubes	2	904.80	39269099
CLS77810	25 mm x 36 Tubes	2	1809.60	39269099
CLS77811	32 mm x 12 Tubes	2	1653.60	39269099

Test Tube Peg Rack

Material: Polypropylene

These racks can conveniently hold inverted tubes for drying purpose and minimizes collection of airborne contaminants inside the tube. This rack can also be used to hold and dry electrophoresis and chromatography plates.

Cat No.	Discription	Pack Size	Price / Pack	HSN CODE
CLS77851	96 Places for 13mm Tubes	6	1216.80	39269099
CLS77852	50 Places for 16mm Tubes	6	1216.80	39269099

Test Tube Stand (Wire Pattern)

Material: Polypropylene

An economical substitute for wire racks, here are these submersible, autoclavable racks which are stackable when empty. These are available in different colors and are made of a special blend of polypropylene that makes it sink in a water bath and maintain their stability even in agitated water. These space saving racks can easily be disassembled for cleaning purposes. The base is in the form of a grid with square openings and has fold up sides and end bars that lock into rack tops.

Cat No.	Discription	Pack Size	Price / Pack	HSN CODE
CLS77901	13 mm x 90 Tubes	6	982.80	39269099
CLS77902	16 mm x 60 Tubes	6	982.80	39269099
CLS77903	20 mm x 40 Tubes	6	982.80	39269099
CLS77904	25 mm x 24 Tubes	6	982.80	39269099
CLS77905	30 mm x 21 Tubes	6	982.80	39269099
CLS77906	13 mm x 36 Tubes	4	967.20	39269099
CLS77907	16 mm x 36 Tubes	4	967.20	39269099

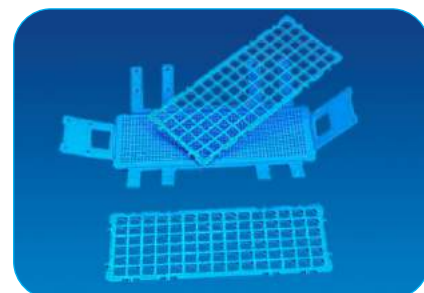
Rack For Micro Centrifuge (Folding)

Material: Polypropylene

These two-tier versatile racks, made of polypropylene, are autoclavable & can be used dry, in water baths or in freezers. These racks are provided with alpha numeric index for easy sample identification. Racks are stackable even when loaded and have purpose designed label spaces on each side.

Cat No.	Discription	Pack Size	Price / Pack	HSN CODE
CLS77910	100 places For 1.5 ml MCT's	6	1216.80	39269099

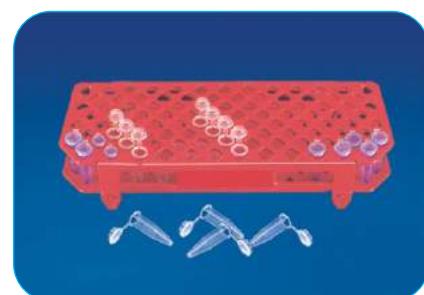
Test Tube Basket

Material: Polypropylene

CLS Test Tube Baskets are made of Polypropylene. These autoclavable, unbreakable and non-corrosive Baskets are ideal for rinsing & draining glassware. These are also useful for storage of test tubes or culture tubes during sterilization or incubation.

Cat No.	Discription	Pack Size	Price / Pack	HSN CODE
CLS78101	140 x 120 x 110 mm	6	608.40	39269099
CLS78102	160 x 160 x 160 mm	6	814.32	39269099



Draining Basket

Material: Polypropylene

As the name suggests, this basket with wide net like structure on all sides prove really useful for draining different laboratory apparatus after washing them. Made of polypropylene, this basket can be repeatedly autoclaved.

Cat No.	Description	Pack Size	Price / Pack	HSN CODE
CLS78103	400 x 400 x 100 mm	6	2995.20	39269099



Pipette Stand (Horizontal)

Material: Polypropylene

This detachable stand can hold 12 pipettes, 6 on each side, in a horizontal position. Moulded in polypropylene, this autoclavable stand has two sides which are attached to each other with three metallic rods coated with polypropylene. This stand can be easily disassembled for space saving storage.

Cat No.	Description	Pack Size	Price / Pack	HSN CODE
CLS79101	For 12 Pipettes	6	936.00	39269099



Pipette Stand (Verticle)

Material: Polypropylene

This is a stable, non-corrosive, detachable stand which can hold 28 pipettes with maximum dia 14 mm. The heavy base measures 225 mm in diameter and a Polypropylene coated square rod measuring 375 mm in length is screwed into the base. The top discs that can be fixed on the rod has holes for holding pipettes while the lower one has pilot holes where the pipette tips rest and liquids drain down to the base. These discs can be adjusted on the rod according to the length of the pipette. The arrows provided on the disc should be kept parallel to ensure that corresponding holes are being centered.

Cat No.	Description	Pack Size	Price / Pack	HSN CODE
CLS79102	For 28 Pipettes	1	530.40	39269099



Pipette Stand (Rotary)

Material: Polypropylene

Moulded in polypropylene, this unique stand holds a maximum of 94 pipettes and rotates on a central vertical axis for convenient selection of any particular pipette. The lower rotating disc has four concentric troughs with tapered sides and open bottoms which cradle the pipette tips protectively and permit water drops to run off. The upper disc has a grid pattern concentric with the bottom disc and keeps the pipettes vertical. Liquids draining off the pipettes are retained on the top of the stationary base by the outer ring. This stand can be easily disassembled & reassembled.

Cat No.	Description	Pack Size	Price / Pack	HSN CODE
CLS79103	For 94 pipettes	1	374.40	39269099



Pipette Box

Material: Polypropylene

Made of polypropylene, this pipette box is designed in such a way that it can hold pipettes of different lengths. The top of the box screws on the bottom and the height can be adjusted by screwing or unscrewing the top.

Cat No.	Description	Pack Size	Price / Pack	HSN CODE
CLS79111	Pipette Box	4	904.80	39231090



Reagent Reservoir

Material: Polypropylene

Moulded in polypropylene, this autoclavable reagent reservoir is helpful for multi-channel pipettes to be used into microtiter plates.

Cat No.	Description	Pack Size	Price / Pack	HSN CODE
CLS79121	75 ml	12	1029.60	39269099



Universal Reagent Reservoir

Material: Polypropylene

This Universal Reagent Reservoir has a graduated single reagent reservoir with maximum volume of 50 ml, reservoir with 8 separate numbered 5ml reagent channels & a reservoir with 12 separate numbered 5ml. reagent channels. Made of polypropylene this reagent reservoir are repeatedly autoclavable and can be used with all multi-channel pipettes.

Cat No.	Discription	Pack Size	Price / Pack	HSN CODE
CLS79131	50 ml	6	748.80	39269099

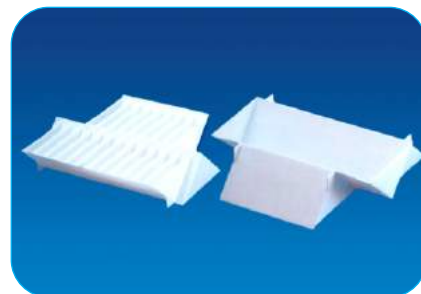

Staining Box

Material: Polypropylene

Moulded in Polypropylene, this staining box helps in staining, fixing, de-staining and handling fragile electrophoresis gels and membranes. Box as well as cover will resist temperatures from -70°C to +70° C. The LDPE plug provides leakproof seal and allows easy liquid drainage.

Cat No.	Discription	Pack Size	Price / Pack	HSN CODE
CLS79301	125 x 125 x 50 mm	2	343.20	39231090



Measuring Cylinders

Material: Polypropylene

CLS Measuring Cylinders, moulded in Polypropylene are single piece cylinders. These autoclavable cylinders have raised prominent graduations for easy reading and have excellent contact clarity. The broad base provides good stability.

Cat No.	Discription	Pack Size	Price / Pack	HSN CODE
CLS80001	10 ml	24	393.12	39269099
CLS80002	25 ml	12	336.96	39269099
CLS80003	50 ml	12	411.84	39269099
CLS80004	100 ml	12	486.72	39269099
CLS80005	250 ml	6	514.80	39269099
CLS80006	500 ml	4	524.16	39269099
CLS80007	1000 ml	3	725.40	39269099
CLS80008	2000 ml	2	1326.00	39269099



Measuring Cylinders Hexagonal

Material: Polypropylene

CLS measuring cylinders are now available with hexagonal base also. The hexagonal base provides excellent stability to the cylinder where as the tapered spout works really well while pouring any reagent.

Cat No.	Discription	Pack Size	Price / Pack	HSN CODE
CLS80031	10 ml	24	449.28	39269099
CLS80032	25 ml	12	336.96	39269099
CLS80033	50 ml	12	411.84	39269099
CLS80034	100 ml	12	505.44	39269099
CLS80035	250 ml	6	514.80	39269099
CLS80036	500 ml	4	524.16	39269099
CLS80037	1000 ml	3	795.60	39269099

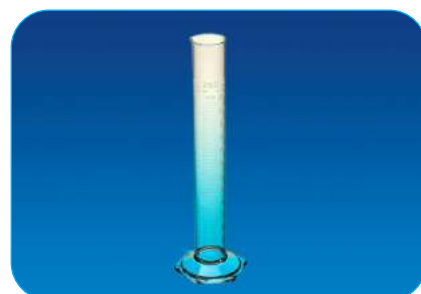

Measuring Jug

Material: Polypropylene

These handy jugs, moulded in Polypropylene, are clear, autoclavable and have good chemical resistance. These jugs are provided with a handle for easy & convenient lifting and have raised graduations for easy reading.

Cat No.	Discription	Pack Size	Price / Pack	HSN CODE
CLS81101	250 ml	12	411.84	39269099
CLS81102	500 ml	12	505.44	39269099
CLS81103	1000 ml	6	449.28	39269099
CLS81104	2000 ml	6	786.24	39269099



Measuring Jug (Euro Design)

Material: Polypropylene

This short form transparent jugs, made of polypropylene are autoclavable and have non-drip spout. These jugs have raised graduations, provide excellent contact clarity & are provided with excellent thumb grip on handle.

Cat No.	Discription	Pack Size	Price / Pack	HSN CODE
CLS81121	500 ml	12	524.16	39269099
CLS81122	1000 ml	6	449.28	39269099
CLS81123	2000 ml	6	786.24	39269099
CLS81124	3000 ml	6	1404.00	39269099
CLS81125	5000 ml	4	1560.00	39269099

Measuring Jug (Printed Graduation)

Material: Polypropylene

This short form transparent jugs, made of polypropylene are autoclavable and have non-drip spout. These jugs have raised graduations, provide excellent contact clarity & are provided with excellent thumb grip on handle.

Cat No.	Discription	Pack Size	Price / Pack	HSN CODE
CLS81131	100 ml	12	393.12	39269099
CLS81132	250 ml	12	655.20	39269099
CLS81133	500 ml	12	1029.60	39269099
CLS81134	1000 ml	6	795.60	39269099
CLS81135	2000 ml	6	1404.00	39269099
CLS81136	5000 ml	4	2028.00	39269099

Conical Measures

Material: Polypropylene

These Conical Measures are very good for measuring small quantities of reagents. Moulded in Polypropylene, these autoclavable Measures have a hexagonal base which provides it excellent stability. The Measures are clear, have good chemical resistance and have raised graduations for easy reading.

Cat No.	Discription	Pack Size	Price / Pack	HSN CODE
CLS81150	12 ml	12	159.12	39269099
CLS81151	25 ml	12	205.92	39269099
CLS81152	50 ml	12	280.80	39269099
CLS81153	125 ml	12	318.24	39269099
CLS81154	200 ml	12	524.16	39269099

Seperatory Funnel

Material: Polypropylene

Seperatory funnel is made of polypropylene, giving it excellent contact clarity and strength. This pear shaped, autoclavable separating funnel has a leakproof threaded screw cap. The polypropylene stopcock, fitted with a self lubricating PTFE plug, is push fitted to the stem of the seperatory funnel.

Cat No.	Discription	Pack Size	Price / Pack	HSN CODE
CLS81201	100 ml	2	530.40	39269099
CLS81202	250 ml	2	624.00	39269099
CLS81203	500 ml	2	780.00	39269099

Scoop

Material: Polypropylene

CLS Scoops are excellent replacement for metallic ones. Moulded in Polypropylene, these scoops are autoclavable and completely eliminate the danger of rusting or corrosion.

Cat No.	Discription	Pack Size	Price / Pack	HSN CODE
CLS81251	2 ml	12	112.32	39269099
CLS81252	5 ml	12	149.76	39269099
CLS81253	10 ml	12	224.64	39269099
CLS81254	25 ml	12	280.80	39269099
CLS81255	50 ml	12	374.40	39269099
CLS81256	100 ml	12	524.16	39269099
CLS81257	250 ml	12	936.00	39269099
CLS81258	500 ml	6	608.40	39269099
CLS81259	1000 ml	6	748.80	39269099



Spatula

Material: Polypropylene

Moulded in Polypropylene, Spatula consists of a spoon on one side while the other end is a flat construction with a knife edge. This edge is helpful in breaking up crystals of different salts while the spoon is used to draw salts from the containers.

Cat No.	Discription	Pack Size	Price / Pack	HSN CODE
CLS81301	150 mm	12	131.04	39269099
CLS81302	200 mm	12	168.48	39269099

Stirrer

Material: Polypropylene

Made of polypropylene, these stirrers are very useful for stirring different solutions in the laboratory. These stirrers prove to be tough and long lasting.

Cat No.	Discription	Pack Size	Price / Pack	HSN CODE
CLS81401	Ø-10 mm x h-250 mm	12	224.64	39269099
CLS81404	Ø-6 mm x h-150 mm	12	93.60	39269099
CLS81405	Ø-7 mm x h-200 mm	12	159.12	39269099
CLS81406	Ø-7 mm x h-250 mm	12	187.20	39269099
CLS81407	Ø-7 mm x h-300 mm	12	224.64	39269099

Policemen Stirring Rods

Material: Polypropylene

This in fact is a multipurpose apparatus which works as a stirrer as well spatula. The fattened ends of this rod form two small spatulas.

Cat No.	Discription	Pack Size	Price / Pack	HSN CODE
CLS81411	Ø-6 mm x h-245 mm	12	224.64	39269099

Soft Loop Sterile

Material: Polypropylene

This non-toxic disposable loop is accurate to semi quantitative stand for handling samples.

Cat No.	Discription	Pack Size	Price / Pack	HSN CODE
CLS81421	1 µl	100	390.00	39269099
CLS81422	10 µl	100	390.00	39269099
CLS81423	Inoculation Needle	100	390.00	39269099

L Shaped Spreader

Material: Polypropylene

This sterile, smooth spreader enables even spreading of liquid samples across the surface of a jar plate without grouping & cutting the medium.

Cat No.	Discription	Pack Size	Price / Pack	HSN CODE
CLS81431	L Shaped Spreader	100	1170.00	39269099

Micro Pestle

Material: Polypropylene

This double ended pestle's one end fits 1.5 ml. Micro centrifuge tube & the other one fits 0.5 ml. Micro centrifuge tube

Cat No.	Discription	Pack Size	Price / Pack	HSN CODE
CLS81441	For 0.5 and 1.5 ml MCT	12	205.92	39269099
CLS81442	For 1.5 ml MCT	12	205.92	39269099



Pneumatic Trough

Material: Polypropylene

Moulded in Polypropylene, Spatula consists of a spoon on one side while the other end is a flat construction with a knife edge. This edge is helpful in breaking up crystals of different salts while the spoon is used to draw salts from the containers.

Cat No.	Description	Pack Size	Price / Pack	HSN CODE
CLS81501	Ø-180 mm x h-60 mm	6	514.80	39269099
CLS81502	Ø-200 mm x h-100 mm	6	814.32	39269099
CLS81503	Ø-250 mm x h-100 mm	4	748.80	39269099



Plantation Pots

Material: Polypropylene

CLS plantation pots, moulded in polypropylene, are available in four different sizes. These pots have a downward extended rim which provide convenient lifting even if the pot is filled. The bottom of the pot is provided with holes for drain purpose.

Cat No.	Description	Pack Size	Price / Pack	HSN CODE
CLS81601	100 mm	20	655.20	39269099
CLS81602	150 mm	20	1248.00	39269099
CLS81603	200 mm	20	2340.00	39269099
CLS81604	250 mm	20	4368.00	39269099



Laboratory Tray

Material: Polypropylene

Needless to say, Polylab Laboratory Tray moulded in polypropylene is a multipurpose tray that can be used for sterilizing, drying glassware, porcelainware & other laboratory instruments. These steam autoclavable trays have tapered walls which prove good for nesting.

Cat No.	Description	Pack Size	Price / Pack	HSN CODE
CLS81701	450 x 350 x 75 mm	10	3510.00	39269099
CLS81702	375 x 300 x 75 mm	10	2496.00	39269099



Utility Tray

Material: Polypropylene

Adding to the already existing range of autoclavable laboratories trays is the Utility Tray and as the name suggests this polypropylene Trays can be utilized for purposes ranging from drying glassware to sterilizing and to store any laboratory apparatus

Cat No.	Description	Pack Size	Price / Pack	HSN CODE
CLS81721	375 x 350 x 130 mm	6	2995.20	39269099
CLS81722	540 x 435 x 130 mm	6	3744.00	39269099



Carrier Tray

Material: Polypropylene

This autoclavable polypropylene Tray has a unique feature i.e its handle which proves really helpful in carrying reagents or laboratory apparatus from one place to another, single handedly.

Cat No.	Description	Pack Size	Price / Pack	HSN CODE
CLS81731	380 x 240 x 115 mm	2	1092.00	39269099



Instrument Tray

Material: Polypropylene

This autoclavable trays have cover which fits into groove of trays to minimize spillage of material. Smaller size can be used to sterilize small instruments whereas the larger size allows pipettes to be fully immersed in disinfectant prior to sterilizing.

Cat No.	Description	Pack Size	Price / Pack	HSN CODE
CLS81736	220 x 150 x 70 mm	2	624.00	39269099
CLS81737	450 x 150 x 70 mm	2	1092.00	39269099



Draining Rack

Material: Acrylonitrile Butadiene Styrene / Polycarbonate

Draining Rack provides an excellent option for post wash draining of tubes & bottles in the laboratory. The back plate has 20 holes into which pegs are tightened with the help of screw-nuts. Bottom of the rack is provided with a tray which collects all the waste water drained down which can further be collected in a container via drain tube. This rack does not rot, stain or rust.

Cat No.	Description	Pack Size	Price / Pack	HSN CODE
CLS81741	Draining Rack	1	2808.00	39269099

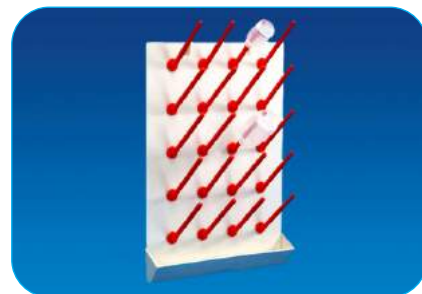

Magenta Box

Material: Polycarbonate/Polypropylene

Magenta Box is very often used in tissue culture & agricultural research experiments. Main body of this box is made of tough & transparent Polycarbonate which provides excellent view of the contents inside while the cover is made of polypropylene. This autoclavable box is square in shape giving itself a space saving feature.

Cat No.	Description	Pack Size	Price / Pack	HSN CODE
CLS81801	Magenta Box	12	1216.80	39231090



Storage Box

Material: Polypropylene

These storage boxes, made of polypropylene, prove to be an excellent option for storage of different powdered reagents & other material in the laboratory. Square shape of these boxes help in saving shelf space. Available in three different sizes, these boxes have polypropylene caps, are autoclavable, provide good chemical resistance & heavy duty service.

Cat No.	Description	Pack Size	Price / Pack	HSN CODE
CLS81900	250 ml	12	505.44	39231090
CLS81901	500 ml	12	636.48	39231090
CLS81902	1000 ml	12	842.40	39231090



Simple Cell Pot

Material: Polypropylene

Simple Cell Pot, as the name suggests, is used for making simple cells & voltmeters etc. Moulded in polypropylene, this pot has very good contact clarity and excellent chemical resistance. Being in polypropylene, this pot is much durable than the one used conventionally.

Cat No.	Description	Pack Size	Price / Pack	HSN CODE
CLS82101	Simple Cell Pot	12	842.40	39269099



Leclanche Cell Pot

Material: Polypropylene

Blown in polypropylene, this pot is used for making leclanche Cell. This pot too has very good contact clarity & excellent chemical resistance.

Cat No.	Description	Pack Size	Price / Pack	HSN CODE
CLS82102	Leclanche Cell Pot	12	1067.04	39269099



Sample Container (Press & Fit Type)

Material: Polypropylene

Made of polypropylene, these disposable containers are used for collecting samples of sputum or urine etc. Graduated on the outer surface, these containers have cap that work in a press & fit manner & make these containers leakproof. These disposable containers are E.T.O sterilized.

Cat No.	Description	Pack Size	Price / Pack	HSN CODE
CLS82103	50 ml	100	936.00	39233090
CLS82104	25 ml	200	1170.00	39233090



Physical Properties of CLS Labware

Resin	Max Use Temp °C	Brittleness Temp °C	Transparency	Sterilization					Specific Gravity	Flexibility	Water Absorption %
				Auto-claving	Gas	Dry Heat	Radiation	Disinfectant			
HDPE	120	-100	Translucent	No	Yes	No	Yes	Yes	0.95	Rigid	<0.01
LDPE	80	-100	Translucent	No	Yes	No	Yes	Yes	0.92	Excel	<0.01
PC	135	-135	Clear	Yes +	Yes	No	No	Yes	1.20	Rigid	0.35
PMMA	50	20	Clear	No	Yes	No	Yes	Some	1.20	Rigid	0.30
PP	135	0	Translucent	Yes	Yes	No	No	Yes	0.90	Rigid	<0.02
PS	90	20	Clear	No	Yes	No	Yes	Some	1.05	Rigid	0.05
PSF	165	-10	Clear	Yes	Yes	Yes +	Yes	Yes	1.24	Rigid	0.30
PTFE	270	-200	Opaque	Yes	Yes	Yes	No	Yes	2.17	Excel	<0.01
PVDF	110	-62	Translucent	Yes	Yes	No	No	Yes	1.75	Rigid	0.05
TPX*	175	20	Clear	Yes	Yes	Yes +	No	Yes	0.83	Rigid	<0.01

Sterilization

- Autoclaving (121°C, 15 psig for 20 minutes) Clean and rinse item with distilled water before autoclaving. Certain Chemicals which have no appreciable effect on resins at room temperature may cause deterioration at autoclaving temperatures.
ALWAYS COMPLETELY DISENGAGE THREADS BEFORE AUTOCLAVING.
- Gas - Ethylene oxide, formaldehyde.
- Dry heat - 160°C for 120 minutes
- Disinfectant - Benzalkonium chloride, Formalin, Ethanol, etc.
- Radiation - gamma irradiated at 2.5 Mrad with unstabilized plastic.
- Sterilizing reduces mechanical strength. Do not use PC vessels for vacuum application if they have been autoclaved.

Chemical Resistance for CLS Labware

Classes of Substances at Room Temperature	HDPE	LDPE	PC	PMMA	PP	PS	PSF	PTFE	PVDF	TPX*
Acids, Dilute or Weak	E	E	E	G	E	E	E	E	E	E
Acids, Strong and Concentrated	E	E	N	N	E	F	G	E	E	E
Alcohols, Aliphatic	E	E	G	N	E	E	G	E	E	E
Aldehydes	G	G	F	G	G	N	F	E	E	G
Bases	E	E	N	F	E	E	E	E	E	E
Esters	G	G	N	N	G	N	N	E	G	G
Hydrocarbons, Aliphatic	G	F	F	G	G	N	G	E	E	F
Hydrocarbons, Aromatic	G	F	N	N	F	N	N	E	E	F
Hydrocarbons, Halogenated	F	N	N	N	F	N	N	E	N	N
Ketones	G	G	N	N	G	N	N	E	N	F
Oxidizing Agents, Strong	F	F	N	N	F	N	G	E	G	F

Resin Code

HDPE	High-density polyethylene
LDPE	Low-density polyethylene
PC	Polycarbonate
PMMA	Polymethyl methacrylate
PP	Polypropylene
PS	Polystyrene
PSF	Polysulfone
PTFE	Polytetrafluoroethylene
PVDF	Polyvinylidene fluoride
TPX*	Polymethylpentene

Chemical Resistance Classification

E = Excellent - 30 days of constant exposure cause no damage. Plastics may even tolerate for years.

G = Good - Little or no damage after 30 days of constant exposure to the reagent.

F = Fair - Some effect after 7 days of constant exposure to the reagent like crazing, cracking, loss of strength or discoloration.

N = Not Recommended - Not for continuous use. Immediate damage may occur.

*TPX is the registered Trade Mark of Mitsui & Co. Ltd.

Petri Dishes, Culture

Made of Borosilicate Glass, Thermal expansion 3.3, heat resistant

Product Code	Approx O.D x Height (mm)	Price / Piece	Pack Size	HSN Code
CLS-A105-01	50 x 17	130.00	100	70179010
CLS-A105-02	80 x 17	180.00	100	70179010
CLS-A105-04	100 x 17	220.00	100	70179010
CLS-A105-05	150 x 20	560.00	40	70179010
CLS-A105-06	200 x 20	1190.00	10	70179010

Dishes, Crystallizing

Made of Borosilicate Glass, Thermal expansion 3.3, heat resistant

Product Code	Approx O.D x Height (mm)	Price / Piece	Pack Size	HSN Code
CLS-A106-01	40 x 25	150.00	100	70179010
CLS-A106-02	50 x 30	165.00	100	70179010
CLS-A106-03	60 x 35	180.00	100	70179010
CLS-A106-04	70 x 40	200.00	100	70179010
CLS-A106-05	80 x 45	220.00	100	70179010
CLS-A106-06	95 x 55	240.00	100	70179010
CLS-A106-07	100 x 50	350.00	10	70179010
CLS-A106-08	150 x 75	640.00	10	70179010
CLS-A106-09	190 x 100	1050.00	10	70179010
CLS-A106-10	300 x 100	4500.00	2	70179010

Dishes, Evaporating, Flat Bottom, With Pour Out

Made of Borosilicate Glass, Thermal expansion 3.3, heat resistant

Product Code	Approx O.D x Height (mm)	Price / Piece	Pack Size	HSN Code
CLS-A107-01	50 x 25	150.00	100	70179010
CLS-A107-02	60 x 30	180.00	100	70179010
CLS-A107-03	70 x 35	190.00	100	70179010
CLS-A107-04	80 x 45	310.00	10	70179010
CLS-A107-05	95 x 55	380.00	10	70179010
CLS-A107-06	105 x 55	440.00	10	70179010
CLS-A107-07	150 x 80	835.00	10	70179010
CLS-A107-08	200 x 100	1550.00	8	70179010

Flask, Filter Heavy Wall, Bolt Neck with Tubulation

Made of Borosilicate Glass, Thermal expansion 3.3, heat resistant

Product Code	Capacity (ml)	Price / Piece	Pack Size	HSN Code
CLS-A109-01	50	175.00	30	70179010
CLS-A109-02	100	275.00	20	70179010
CLS-A109-03	250	405.00	10	70179010
CLS-A109-04	500	495.00	20	70179010
CLS-A109-05	1000	760.00	10	70179010
CLS-A109-06	2000	1480.00	5	70179010
CLS-A109-07	3000	3850.00	2	70179010
CLS-A109-08	5000	5450.00	2	70179010
CLS-A109-09	10000	9570.00	1	70179010
CLS-A109-10	20000	15250.00	1	70179010



Gas Generator, Keeps Apparatus

Made of Borosilicate Glass, Thermal expansion 3.3, heat resistant

Product Code	Capacity (ml)	Price / Piece	Pack Size	HSN Code
CLS-A108-01	500	7500.00	1	70179010
CLS-A108-02	1000	8900.00	1	70179010



Flasks, Iodine, Determination, Interchangeable Stopper

Made of Borosilicate Glass, Thermal expansion 3.3, heat resistant

Product Code	Capacity (ml)	Interchangeable Joint	Price / Piece	Pack Size	HSN Code
CLS-A110-01	100	24 / 29	180.00	10	70179010
CLS-A110-02	250	24 / 29	240.00	10	70179010
CLS-A110-03	500	24 / 29	305.00	10	70179010
CLS-A110-04	1000	24 / 29	760.00	4	70179010



Flask, Erlenmeyer / Conical, Narrow Neck with Graduation

Made of Borosilicate Glass, Thermal expansion 3.3, heat resistant

Product Code	Capacity (ml)	Approx. Neck O.D (mm)	Price / Piece	Pack Size	HSN Code
CLS-A111-01	25	18	75.00	20	70179010
CLS-A111-02	50	22	75.00	20	70179010
CLS-A111-03	100	22	75.00	20	70179010
CLS-A111-04	150	28	92.00	20	70179010
CLS-A111-05	250	34	115.00	40	70179010
CLS-A111-06	500	34	165.00	40	70179010
CLS-A111-07	1000	42	285.00	20	70179010
CLS-A111-08	2000	50	505.00	10	70179010
CLS-A111-09	3000	50	1250.00	4	70179010
CLS-A111-10	5000	50	2280.00	2	70179010
CLS-A111-11	10000	60	7500.00	1	70179010



Flask, Erlenmeyer / Conical, Wide Neck with Graduation

Made of Borosilicate Glass, Thermal expansion 3.3, heat resistant

Product Code	Capacity (ml)	Approx. Neck O.D (mm)	Price / Piece	Pack Size	HSN Code
CLS-A112-01	25	31	76.00	20	70179010
CLS-A112-02	50	34	76.00	20	70179010
CLS-A112-03	100	34	85.00	20	70179010
CLS-A112-04	150	34	105.00	20	70179010
CLS-A112-05	250	50	140.00	40	70179010
CLS-A112-06	500	50	195.00	40	70179010
CLS-A112-07	1000	50	340.00	20	70179010
CLS-A112-08	2000	72	850.00	10	70179010
CLS-A112-09	3000	48	1550.00	4	70179010
CLS-A112-10	5000	50	2250.00	2	70179010
CLS-A112-11	10000	80	8900.00	1	70179010

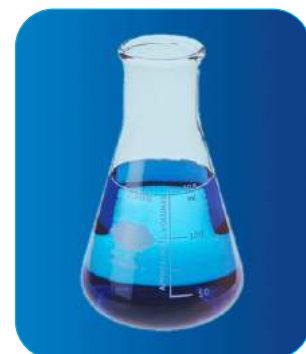

Flask, Erlenmeyer / Conical, Narrow Neck with Interchangeable Joint

Made of Borosilicate Glass, Thermal expansion 3.3, heat resistant

Product Code	Capacity (ml)	Interchangeable Joint	Price / Piece	Pack Size	HSN Code
CLS-A113-01	25	14 / 23	125.00	10	70179010
CLS-A113-02	50	19 / 26	130.00	10	70179010
CLS-A113-03	100	19 / 26	165.00	10	70179010
CLS-A113-04	250	24 / 29	180.00	10	70179010
CLS-A113-05	500	24 / 29	270.00	5	70179010
CLS-A113-06	1000	29 / 32	550.00	5	70179010
CLS-A113-07	2000	29 / 32	1080.00	2	70179010

Flask, Erlenmeyer / Conical, With Teflon Liner Screw Cap

Made of Borosilicate Glass, Thermal expansion 3.3, heat resistant

Product Code	Capacity (ml)	Price / Piece	Pack Size	HSN Code
CLS-A114-01	50	170.00	20	70179010
CLS-A114-02	100	215.00	20	70179010
CLS-A114-03	150	245.00	20	70179010
CLS-A114-04	250	290.00	20	70179010
CLS-A114-05	500	365.00	10	70179010
CLS-A114-06	1000	700.00	10	70179010

Flask, Erlenmeyer / Conical, Narrow Mouth, With Interchangeable Stopper

Made of Borosilicate Glass, Thermal expansion 3.3, heat resistant

Product Code	Capacity (ml)	Interchangeable Joint	Price / Piece	Pack Size	HSN Code
CLS-A115-01	50	19 / 26	205.00	10	70179010
CLS-A115-02	100	24 / 29	225.00	20	70179010
CLS-A115-03	150	24 / 29	240.00	20	70179010
CLS-A115-04	250	24 / 29	260.00	10	70179010
CLS-A115-05	500	24 / 29	385.00	10	70179010
CLS-A115-06	1000	29 / 32	540.00	10	70179010

Flask, Flat Bottom, Narrow Neck with Beaded Rim

Made of Borosilicate Glass, Thermal expansion 3.3, heat resistant

Product Code	Capacity (ml)	Approx. Neck O.D (mm)	Price / Piece	Pack Size	HSN Code
CLS-A116-01	25	20	79.00	50	70179010
CLS-A116-02	50	26	89.00	70	70179010
CLS-A116-03	100	26	99.00	50	70179010
CLS-A116-04	150	28	102.00	10	70179010
CLS-A116-05	250	34	105.00	80	70179010
CLS-A116-06	500	34	180.00	40	70179010
CLS-A116-07	1000	42	245.00	20	70179010
CLS-A116-08	2000	51	580.00	2	70179010
CLS-A116-09	3000	50	1450.00	2	70179010
CLS-A116-10	5000	60	2380.00	2	70179010
CLS-A116-11	6000	65	3180.00	1	70179010
CLS-A116-12	10000	65	5150.00	1	70179010
CLS-A116-13	20000	87	9390.00	1	70179010



Flask, Round Bottom, Narrow Neck with Beaded Rim

Made of Borosilicate Glass, Thermal expansion 3.3, heat resistant

Product Code	Capacity (ml)	Approx. Neck O.D (mm)	Price / Piece	Pack Size	HSN Code
CLS-B116-01	25	20	79.00	50	70179010
CLS-B116-02	50	26	89.00	70	70179010
CLS-B116-03	100	26	99.00	50	70179010
CLS-B116-04	150	28	102.00	10	70179010
CLS-B116-05	250	34	105.00	80	70179010
CLS-B116-06	500	34	180.00	40	70179010
CLS-B116-07	1000	42	245.00	20	70179010
CLS-B116-08	2000	51	580.00	2	70179010
CLS-B116-09	3000	50	1450.00	2	70179010
CLS-B116-10	5000	60	2380.00	2	70179010
CLS-B116-11	6000	65	3180.00	1	70179010
CLS-B116-12	10000	65	5150.00	1	70179010
CLS-B116-13	20000	87	9390.00	1	70179010

Flask, Round Bottom, Wide Neck with Beaded Rim

Made of Borosilicate Glass, Thermal expansion 3.3, heat resistant

Product Code	Capacity (ml)	Approx. Neck O.D (mm)	Price / Piece	Pack Size	HSN Code
CLS-A117-01	50	34	85.00	70	70179010
CLS-A117-02	100	35	140.00	50	70179010
CLS-A117-03	250	51	190.00	80	70179010
CLS-A117-04	500	50	320.00	40	70179010
CLS-A117-05	1000	50	450.00	20	70179010
CLS-A117-06	2000	76	1050.00	2	70179010

Flask, Flat Bottom, Wide Neck with Beaded Rim

Made of Borosilicate Glass, Thermal expansion 3.3, heat resistant

Product Code	Capacity (ml)	Approx. Neck O.D (mm)	Price / Piece	Pack Size	HSN Code
CLS-B117-01	50	34	85.00	70	70179010
CLS-B117-02	100	35	140.00	50	70179010
CLS-B117-03	250	51	190.00	80	70179010
CLS-B117-04	500	50	320.00	40	70179010
CLS-B117-05	1000	50	450.00	20	70179010
CLS-B117-06	2000	76	1050.00	2	70179010

Flask, Round Bottom, with Socket

Made of Borosilicate Glass, Thermal expansion 3.3, heat resistant

Product Code	Capacity (ml)	Interchangeable Joint	Price / Piece	Pack Size	HSN Code
CLS-A118-01	50	B-14 B-19	95.00	70	70179010
CLS-A118-02	100	B-24 B-19	140.00	50	70179010
CLS-A118-03	150	B-24 B-19	150.00	50	70179010
CLS-A118-04	250	B-24 B-19	160.00	80	70179010
CLS-A118-05	500	B-24 B-19	240.00	40	70179010
CLS-A118-06	1000	B-24 B-19	340.00	20	70179010
CLS-A118-07	2000	B-24 B-19	625.00	2	70179010
CLS-A118-08	3000	B-34 B-40	1650.00	2	70179010
CLS-A118-09	5000	B-34 B-40	2940.00	1	70179010
CLS-A118-10	10000	B-40 B-50	6400.00	1	70179010
CLS-A118-11	20000	B-40 B-50	9800.00	1	70179010



Flask, Flat Bottom, with Socket

Made of Borosilicate Glass, Thermal expansion 3.3, heat resistant

Product Code	Capacity (ml)	Interchangeable Joint	Price / Piece	Pack Size	HSN Code
CLS-B118-01	50	B-14 B-19	95.00	70	70179010
CLS-B118-02	100	B-24 B-19	140.00	50	70179010
CLS-B118-03	150	B-24 B-19	150.00	50	70179010
CLS-B118-04	250	B-24 B-19	160.00	80	70179010
CLS-B118-05	500	B-24 B-19	240.00	40	70179010
CLS-B118-06	1000	B-24 B-19	340.00	20	70179010
CLS-B118-07	2000	B-24 B-19	625.00	2	70179010
CLS-B118-08	3000	B-34 B-40	1650.00	2	70179010
CLS-B118-09	5000	B-34 B-40	2940.00	1	70179010
CLS-B118-10	10000	B-40 B-50	6400.00	1	70179010
CLS-B118-11	20000	B-40 B-50	9800.00	1	70179010

Flask, Round Bottom, Two Neck, Centre Neck and One Angled Side Neck with Interchangeable Joint

Made of Borosilicate Glass, Thermal expansion 3.3, heat resistant

Product Code	Capacity (ml)	Interchangeable Joint		Price / Piece	Pack Size	HSN Code
		Centre Neck	Side Neck			
CLS-A119-01	100	24 / 29	14 / 23	210.00	4	70179010
CLS-A119-02	100	24 / 29	19 / 26	210.00	4	70179010
CLS-A119-03	100	24 / 29	14 / 23	210.00	4	70179010
CLS-A119-04	250	24 / 29	19 / 26	290.00	4	70179010
CLS-A119-05	250	29 / 32	14 / 23	290.00	4	70179010
CLS-A119-06	500	24 / 29	14 / 23	410.00	4	70179010
CLS-A119-07	500	29 / 32	19 / 26	410.00	4	70179010
CLS-A119-08	1000	24 / 29	14 / 23	520.00	2	70179010
CLS-A119-09	1000	24 / 29	19 / 26	520.00	2	70179010
CLS-A119-10	1000	29 / 32	14 / 23	520.00	2	70179010
CLS-A119-11	2000	34 / 35	19 / 26	920.00	2	70179010
CLS-A119-12	3000	34/ 35	24/29	2410.00	2	70179010
CLS-A119-13	5000	34/ 35	24/29	3650.00	1	70179010
CLS-A119-14	10000	34/ 35	24/29	6650.00	1	70179010
CLS-A119-15	20000	55/ 44	24/29	10500.00	1	70179010

Bottles, Reagent, wide Mouth with Screw Cap

Made of Borosilicate Glass, Thermal expansion 3.3, heat resistant

Product Code	Capacity (ml)	Price / Piece	Pack Size	HSN Code
CLS-A122-01	25	230.00	20	70179010
CLS-A122-02	50	270.00	20	70179010
CLS-A122-03	100	280.00	10	70179010
CLS-A122-04	250	290.00	10	70179010
CLS-A122-05	500	310.00	10	70179010
CLS-A122-06	1000	505.00	10	70179010
CLS-A122-07	2000	910.00	10	70179010
CLS-A122-08	5000	4900.00	1	70179010
CLS-A122-09	10000	8400.00	1	70179010
CLS-A122-10	20000	15250.00	1	70179010



Flask, Round Bottom, Three Neck, Centre Neck and Two Angled Side Neck with Interchangeable Joint

Made of Borosilicate Glass, Thermal expansion 3.3, heat resistant

Product Code	Capacity (ml)	Interchangeable Joint		Price / Piece	Pack Size	HSN Code
		Centre Neck	Side Neck			
CLS-A120-01	100	19 / 26	14 / 23	305.00	4	70179010
CLS-A120-02	100	24 / 29	14 / 23	305.00	4	70179010
CLS-A120-03	100	24 / 29	19 / 26	305.00	4	70179010
CLS-A120-04	250	19 / 26	19 / 26	380.00	4	70179010
CLS-A120-05	250	24 / 29	14 / 23	380.00	4	70179010
CLS-A120-06	250	24 / 29	19 / 26	380.00	4	70179010
CLS-A120-07	250	29 / 32	14 / 23	380.00	4	70179010
CLS-A120-08	250	29 / 32	19 / 26	380.00	4	70179010
CLS-A120-09	500	24 / 29	14 / 23	570.00	4	70179010
CLS-A120-10	500	29 / 32	19 / 26	570.00	4	70179010
CLS-A120-11	500	24 / 29	14 / 23	570.00	4	70179010
CLS-A120-12	500	29 / 32	19 / 26	570.00	4	70179010
CLS-A120-13	1000	24 / 29	14 / 23	720.00	2	70179010
CLS-A120-14	1000	24 / 29	19 / 26	720.00	2	70179010
CLS-A120-15	2000	24 / 29	19 / 26	1290.00	2	70179010
CLS-A120-16	2000	29 / 32	24 / 29	1290.00	2	70179010
CLS-A120-17	3000	34 / 35	24 / 29	3250.00	2	70179010
CLS-A120-18	5000	34 / 35	24 / 29	4650.00	1	70179010
CLS-A120-19	10000	34 / 35	24 / 29	8950.00	1	70179010
CLS-A120-20	20000	55 / 44	24 / 29	12500.00	1	70179010

Flask, Round Bottom, Three Neck, Centre Neck and Two Parallel Side Neck with Interchangeable Joint

Made of Borosilicate Glass, Thermal expansion 3.3, heat resistant

Product Code	Capacity (ml)	Interchangeable Joint		Price / Piece	Pack Size	HSN Code
		Centre Neck	Side Neck's			
CLS-A121-01	250	24 / 29	19 / 26	380.00	4	70179010
CLS-A121-02	250	29 / 32	14 / 23	380.00	4	70179010
CLS-A121-03	500	24 / 29	19 / 26	570.00	4	70179010
CLS-A121-04	500	29 / 32	14 / 23	570.00	4	70179010
CLS-A121-05	500	29 / 32	19 / 26	570.00	4	70179010
CLS-A121-06	1000	29 / 32	14 / 23	720.00	2	70179010
CLS-A121-07	1000	24 / 29	19 / 26	720.00	2	70179010
CLS-A121-08	1000	29 / 32	19 / 26	720.00	2	70179010
CLS-A121-09	2000	24 / 29	19 / 26	1290.00	2	70179010
CLS-A121-10	2000	29 / 32	19 / 26	1290.00	2	70179010
CLS-A121-11	2000	34 / 35	19 / 26	1290.00	2	70179010
CLS-A121-12	2000	34 / 35	24 / 29	1290.00	2	70179010
CLS-A121-13	3000	34 / 35	24 / 29	3250.00	2	70179010
CLS-A121-14	5000	34 / 35	24 / 29	4650.00	1	70179010
CLS-A121-15	10000	34 / 35	24 / 29	8950.00	1	70179010
CLS-A121-16	20000	55 / 44	24 / 29	12500.00	1	70179010



Bottles, Reagent, Plain, Narrow mouth with Interchangeable Stopper

Made of Borosilicate Glass, Thermal expansion 3.3, heat resistant

Product Code	Capacity (ml)	Stopper Size	Price / Piece	Pack Size	HSN Code
CLS-A123-01	30	B-14	240.00	40	70179010
CLS-A123-02	60	B-14	305.00	40	70179010
CLS-A123-03	125	B-19	280.00	50	70179010
CLS-A123-04	250	B-19	310.00	10	70179010
CLS-A123-05	500	B-24	335.00	10	70179010
CLS-A123-06	1000	B-29	525.00	10	70179010
CLS-A123-07	2000	B-34	1450.00	10	70179010
CLS-A123-08	3000	B-40	3890.00	1	70179010
CLS-A123-09	5000	B-40	4250.00	1	70179010
CLS-A123-10	10000	B-55	8500.00	1	70179010
CLS-A123-11	20000	B-55	9900.00	1	70179010

Bottles, Aspirator, With GL 45 Cap and Interchangeable Stopcock

Made of Borosilicate Glass, Thermal expansion 3.3, heat resistant

Product Code	Capacity (ml)	Approx. I.D Outlet (mm)	Price / Piece	Pack Size	HSN Code
CLS-A124-01	1000	24 / 29	2150.00	10	70179010
CLS-A124-02	2000	29 / 32	2590.00	4	70179010
CLS-A124-03	5000	29 / 32	8560.00	1	70179010
CLS-A124-04	10000	29 / 32	11500.00	1	70179010
CLS-A124-05	20000	29 / 32	15900.00	1	70179010

Bottles, Aspirator, With GL 45 Cap and Outlet for Tubing

Made of Borosilicate Glass, Thermal expansion 3.3, heat resistant

Product Code	Capacity (ml)	Price / Piece	Pack Size	HSN Code
CLS-A125-01	250	310.00	10	70179010
CLS-A125-02	500	340.00	10	70179010
CLS-A125-03	1000	860.00	10	70179010
CLS-A125-04	2000	1025.00	5	70179010

Bottles, Solution, Plain, Tooled Neck

Made of Borosilicate Glass, Thermal expansion 3.3, heat resistant

Product Code	Capacity (ml)	Approx. Neck I.D (mm)	Price / Piece	Pack Size	HSN Code
CLS-A126-01	250	18	270.00	20	70179010
CLS-A126-02	500	23	310.00	20	70179010
CLS-A126-03	1000	28	510.00	10	70179010
CLS-A126-04	2000	33	875.00	10	70179010



Bottles, B. O. D, with interchangeable Stopper

Made of Borosilicate Glass, Thermal expansion 3.3, heat resistant

Product Code	Capacity (ml)	Price / Piece	Pack Size	HSN Code
CLS-A127-01	125	430.00	30	70179010
CLS-A127-02	300	510.00	10	70179010

Bottles, Weighing, with Interchangeable Stopper

Made of Borosilicate Glass, Thermal expansion 3.3, heat resistant

Product Code	Capacity (ml)	Price / Piece	Pack Size	HSN Code
CLS-A128-01	5	240.00	30	70179010
CLS-A128-02	15	245.00	10	70179010
CLS-A128-03	20	352.00	10	70179010
CLS-A128-04	25	450.00	10	70179010
CLS-A128-05	40	520.00	10	70179010
CLS-A128-06	60	750.00	5	70179010

Bottles, Specific Gravity, with Caplary Bore & Glass Stopper

Made of Borosilicate Glass, Thermal expansion 3.3, heat resistant

Product Code	Capacity (ml)	Price / Piece	Pack Size	HSN Code
CLS-A129-01	5	290.00	20	70179010
CLS-A129-02	10	355.00	10	70179010
CLS-A129-03	25	365.00	10	70179010
CLS-A129-04	50	390.00	10	70179010
CLS-A129-05	100	480.00	5	70179010

Flask, Volumetric, with Interchangeable glass Stopper

Made of Borosilicate Glass, Thermal expansion 3.3, heat resistant

Product Code	Capacity (ml)	Stopper Size	Price / Piece	Pack Size	HSN Code
CLS-A130-01	5	10 / 15	190.00	10	70179010
CLS-A130-02	10	10 / 15	205.00	10	70179010
CLS-A130-03	25	10 / 15	205.00	10	70179010
CLS-A130-04	50	10 / 15	220.00	10	70179010
CLS-A130-05	100	14 / 15	240.00	10	70179010
CLS-A130-06	200	14 / 15	285.00	10	70179010
CLS-A130-07	250	14 / 15	290.00	10	70179010
CLS-A130-08	500	19 / 20	390.00	10	70179010
CLS-A130-09	1000	19 / 20	580.00	10	70179010
CLS-A130-10	2000	24 / 25	1050.00	2	70179010
CLS-A130-11	5000	34 / 35	4950.00	1	70179010



Flasks, Sugar, with Two Marks

Made of Borosilicate Glass, Thermal expansion 3.3, heat resistant

Product Code	Capacity (ml)	Tolerance \pm ml	Price / Piece	Pack Size	HSN Code
CLS-A131-01	50	0.1	160.00	20	70179010
CLS-A131-02	100	0.15	247.00	10	70179010
CLS-A131-03	200	0.25	305.00	10	70179010

Measuring Cylinders, Graduated, Round Base

Made of Borosilicate Glass, Thermal expansion 3.3, heat resistant

Product Code	Capacity (ml)	Approx Height (mm)	Price / Piece	Pack Size	HSN Code
CLS-A132-01	5	110	180.00	5	70179010
CLS-A132-02	10	140	205.00	5	70179010
CLS-A132-03	25	170	240.00	10	70179010
CLS-A132-04	50	200	290.00	10	70179010
CLS-A132-05	100	260	310.00	10	70179010
CLS-A132-06	250	335	505.00	10	70179010
CLS-A132-07	500	390	770.00	5	70179010
CLS-A132-08	1000	470	1150.00	4	70179010
CLS-A132-09	2000	570	2360.00	4	70179010

Measuring Cylinders, Graduated, Round Base, Stopped Cylinder

Made of Borosilicate Glass, Thermal expansion 3.3, heat resistant

Product Code	Capacity (ml)	Approx Height (mm)	Price / Piece	Pack Size	HSN Code
CLS-A133-01	5	138	250.00	5	70179010
CLS-A133-02	10	142	270.00	5	70179010
CLS-A133-03	25	188	350.00	10	70179010
CLS-A133-04	50	218	390.00	10	70179010
CLS-A133-05	100	285	470.00	10	70179010
CLS-A133-06	250	368	780.00	5	70179010
CLS-A133-07	500	425	1145.00	5	70179010
CLS-A133-08	1000	530	1650.00	4	70179010
CLS-A133-09	2000	640	3150.00	4	70179010

Measuring Cylinders, Graduated, Hexagonal Base

Made of Borosilicate Glass, Thermal expansion 3.3, heat resistant

Product Code	Capacity (ml)	Approx Height (mm)	Price / Piece	Pack Size	HSN Code
CLS-A134-01	5	110	205.00	5	70179010
CLS-A134-02	10	140	225.00	5	70179010
CLS-A134-03	25	170	295.00	10	70179010
CLS-A134-04	50	200	315.00	10	70179010
CLS-A134-05	100	260	350.00	10	70179010
CLS-A134-06	250	335	570.00	10	70179010
CLS-A134-07	500	390	890.00	5	70179010
CLS-A134-08	1000	470	1250.00	4	70179010
CLS-A134-09	2000	570	2570.00	4	70179010



Measuring Cylinders, Graduated, Hexagonal Base, Stopped Cylinder

Made of Borosilicate Glass, Thermal expansion 3.3, heat resistant

Product Code	Capacity (ml)	Approx Height (mm)	Price / Piece	Pack Size	HSN Code
CLS-A135-01	5	138	340.00	5	70179010
CLS-A135-02	10	142	350.00	5	70179010
CLS-A135-03	25	188	405.00	10	70179010
CLS-A135-04	50	218	440.00	10	70179010
CLS-A135-05	100	285	555.00	10	70179010
CLS-A135-06	250	368	880.00	5	70179010
CLS-A135-07	500	425	1295.00	5	70179010
CLS-A135-08	1000	530	1870.00	4	70179010
CLS-A135-09	2000	640	3390.00	4	70179010

Millipore Type Membrane Filter Holder Assembly Complete Unit without Pump

Made of Borosilicate Glass, Thermal expansion 3.3, heat resistant

Product Code	Capacity (ml)	Filteration Base Size (mm)	Price / Piece	Pack Size	HSN Code
CLS-A136-01	125	25	4900.00	1	70179010
CLS-A136-02	500	47	10500.00	1	70179010
CLS-A136-03	1000	47	12900.00	1	70179010
CLS-A136-04	2000	47	15750.00	1	70179010
CLS-A136-05	5000	90	80500.00	1	70179010

Spare Flask

Made of Borosilicate Glass, Thermal expansion 3.3, heat resistant

Product Code	Capacity (ml)	Price / Piece	Pack Size	HSN Code
CLS-A136-06	125	2200.00	1	70179010
CLS-A136-07	500	2400.00	1	70179010
CLS-A136-08	1000	3200.00	1	70179010
CLS-A136-09	2000	7500.00	1	70179010
CLS-A136-10	5000	26500.00	1	70179010

Crucible, Gooch Type, With Sinterd Disc of Porosity G-0,1,2,3

Made of Borosilicate Glass, Thermal expansion 3.3, heat resistant

Product Code	Capacity (ml)	Disc Diameter (mm)	Price / Piece	Pack Size	HSN Code
CLS-A137-01	15	20	160.00	4	70179010
CLS-A137-02	30	30	250.00	4	70179010
CLS-A137-03	50	40	320.00	4	70179010

 Speak to our expert
 +91-120-4968617

 Email: sales@compositelabline.com

 Visit: www.compositelabline.com

Funnels, Buchner, With Sintered Disc of Porosity

Made of Borosilicate Glass, Thermal expansion 3.3, heat resistant

Product Code	Capacity (ml)	Disc Diameter (mm)	Approx Height (mm)	Price / Piece	Pack Size	HSN Code
CLS-A138-01	15	20	110	350.00	5	70179010
CLS-A138-02	35	30	137	415.00	5	70179010
CLS-A138-03	80	40	149	680.00	5	70179010
CLS-A138-04	200	65	205	1050.00	5	70179010
CLS-A138-05	500	90	255	3280.00	5	70179010
CLS-A138-06	1000	125	275	6200.00	2	70179010
CLS-A138-07	2000	145	300	9500.00	2	70179010

Burettes - Rotaflow Stopcock Burette & Separating Interchangeable Cap Leak Proof

Made of Borosilicate Glass, Thermal expansion 3.3, heat resistant

Product Code	Capacity (ml)	Price / Piece	Pack Size	HSN Code
CLS-A139-01	10	450.00	5	70179010
CLS-A139-02	25	510.00	5	70179010
CLS-A139-03	50	550.00	5	70179010

Burettes, Straight Bore with Glass Key Stopcock

Made of Borosilicate Glass, Thermal expansion 3.3, heat resistant

Product Code	Capacity (ml)	Price / Piece	Pack Size	HSN Code
CLS-A140-01	1	550.00	5	70179010
CLS-A140-02	2	550.00	5	70179010
CLS-A140-03	5	690.00	5	70179010
CLS-A140-04	10	610.00	5	70179010
CLS-A140-05	25	610.00	5	70179010
CLS-A140-06	50	610.00	5	70179010
CLS-A140-07	100	790.00	5	70179010

Burettes, Straight Bore with P.T.F. Key Stopcock,

Made of Borosilicate Glass, Thermal expansion 3.3, heat resistant

Product Code	Capacity (ml)	Price / Piece	Pack Size	HSN Code
CLS-A141-01	1	550.00	5	70179010
CLS-A141-02	2	550.00	5	70179010
CLS-A141-03	5	610.00	5	70179010
CLS-A141-04	10	650.00	5	70179010
CLS-A141-05	25	690.00	5	70179010
CLS-A141-06	50	750.00	5	70179010
CLS-A141-07	100	950.00	5	70179010



Burettes, Rotaflow Stopcock, Teflon

Made of Borosilicate Glass, Thermal expansion 3.3, heat resistant

Product Code	Capacity (ml)	Price / Piece	Pack Size	HSN Code
CLS-A142-01	1	350.00	5	70179010
CLS-A142-02	2	350.00	5	70179010
CLS-A142-03	5	350.00	5	70179010
CLS-A142-04	10	490.00	5	70179010
CLS-A142-05	25	490.00	5	70179010
CLS-A142-06	50	520.00	5	70179010
CLS-A142-07	100	750.00	5	70179010

Burettes, Pinchcock, with Tip, Clamp

Made of Borosilicate Glass, Thermal expansion 3.3, heat resistant

Product Code	Capacity (ml)	Price / Piece	Pack Size	HSN Code
CLS-A143-01	10	180.00	5	70179010
CLS-A143-02	25	210.00	5	70179010
CLS-A143-03	50	280.00	5	70179010
CLS-A143-04	100	580.00	5	70179010

Burettes, Automatic Zero, With Reservoir, Accuracy as per Class B, Rubber Bellow and Glass Key, Stopcock

Made of Borosilicate Glass, Thermal expansion 3.3, heat resistant

Product Code	Capacity (ml)	Price / Piece	Pack Size	HSN Code
CLS-A144-01	10	3550.00	1	70179010
CLS-A144-02	25	4050.00	1	70179010
CLS-A144-03	50	4250.00	1	70179010
CLS-A144-04	100	4550.00	1	70179010

Burettes, Automatic Zero, With Reservoir, Accuracy as per Class B, Rubber Bellow and Rotaflow Teflon Stopcock

Made of Borosilicate Glass, Thermal expansion 3.3, heat resistant

Product Code	Capacity (ml)	Price / Piece	Pack Size	HSN Code
CLS-A145-01	10	4050.00	1	70179010
CLS-A145-02	25	4100.00	1	70179010
CLS-A145-03	50	4200.00	1	70179010
CLS-A145-04	100	4800.00	1	70179010

Chromatography Column, Rotaflow Stopcock

Made of Borosilicate Glass, Thermal expansion 3.3, heat resistant

Product Code	Diameter (mm)	Approx Affective Length (mm)	Price / Piece	Pack Size	HSN Code
CLS-A146-01	10	150	280.00	5	70179010
CLS-A146-02	15	300	350.00	5	70179010
CLS-A146-03	15	350	390.00	5	70179010
CLS-A146-04	20	450	490.00	5	70179010
CLS-A146-05	40	600	750.00	5	70179010



Chromatography Column, Glass stopcock

Made of Borosilicate Glass, Thermal expansion 3.3, heat resistant

Product Code	Diameter (mm)	Approx Affective Length (mm)	Price / Piece	Pack Size	HSN Code
CLS-A147-01	10	150	380.00	5	70179010
CLS-A147-02	15	300	430.00	5	70179010
CLS-A147-03	15	350	590.00	5	70179010
CLS-A147-04	20	450	640.00	5	70179010
CLS-A147-05	40	600	770.00	5	70179010

Chromatography Column, PTFE Stopcock

Made of Borosilicate Glass, Thermal expansion 3.3, heat resistant

Product Code	Diameter (mm)	Approx Affective Length (mm)	Price / Piece	Pack Size	HSN Code
CLS-A148-01	10	150	760.00	5	70179010
CLS-A148-02	15	300	800.00	5	70179010
CLS-A148-03	15	350	1040.00	5	70179010
CLS-A148-04	20	450	1090.00	5	70179010
CLS-A148-05	40	600	1340.00	5	70179010

Condensers, Air

Made of Borosilicate Glass, Thermal expansion 3.3, heat resistant

Product Code	Cone	Affective Length (mm)	Price / Piece	Pack Size	HSN Code
CLS-A149-01	14/23	300	370.00	5	70179010
CLS-A149-02	19/26	400	400.00	5	70179010
CLS-A149-03	24/29	500	510.00	5	70179010
CLS-A149-04	24/29	750	590.00	5	70179010
CLS-A149-05	24/29	1000	690.00	5	70179010

Extractor, Soxhlet Extraction Apparatus Complete with Allihn Condenser, Interchangeable joint

Made of Borosilicate Glass, Thermal expansion 3.3, heat resistant

Product Code	Flask Size (ml)	Capacity (ml)	Price / Piece	Pack Size	HSN Code
CLS-A150-01	150	60	1250.00	1	70179010
CLS-A150-02	250	100	1550.00	1	70179010
CLS-A150-03	500	200	2590.00	1	70179010
CLS-A150-04	1000	500	8500.00	1	70179010
CLS-A150-05	3000	1000	13500.00	1	70179010

Condensers, Allihn, Drip Tip, Interchangeable Joint

Made of Borosilicate Glass, Thermal expansion 3.3, heat resistant

Product Code	Approx Length (mm)	Interchangeable Joint	Price / Piece	Pack Size	HSN Code
CLS-A151-01	200	19 / 26	550.00	5	70179010
CLS-A151-02	300	24 / 29	590.00	5	70179010
CLS-A151-03	400	24 / 29	690.00	5	70179010



Condensers, Liebig

Made of Borosilicate Glass, Thermal expansion 3.3, heat resistant

Product Code	Approx Length (mm)	Interchangeable Joint	Price / Piece	Pack Size	HSN Code
CLS-A152-01	200	B-19	390.00	5	70179010
CLS-A152-02	200	B-24	390.00	5	70179010
CLS-A152-03	300	B-19	390.00	5	70179010
CLS-A152-04	300	B-24	390.00	5	70179010
CLS-A152-05	400	B-19	470.00	5	70179010
CLS-A152-06	400	B-24	470.00	5	70179010
CLS-A152-07	500	B-19	480.00	5	70179010
CLS-A152-08	500	B-24	480.00	5	70179010

Condensers, Graham, Coiled Distillate Type, Drip Tip, Interchangeable Joint

Made of Borosilicate Glass, Thermal expansion 3.3, heat resistant

Product Code	Approx Length (mm)	Interchangeable Joint	Price / Piece	Pack Size	HSN Code
CLS-A153-01	300	24 / 29	650.00	5	70179010
CLS-A153-02	400	24 / 29	690.00	5	70179010
CLS-A153-03	500	24 / 29	850.00	5	70179010

Condensers, Devies, Double Surface

Made of Borosilicate Glass, Thermal expansion 3.3, heat resistant

Product Code	Approx Length (mm)	Interchangeable Joint	Price / Piece	Pack Size	HSN Code
CLS-A154-01	200	24 / 29	1750.00	5	70179010
CLS-A154-02	300	24 / 29	2400.00	5	70179010
CLS-A154-03	400	24 / 29	2590.00	5	70179010

Funnels, Separating, Pear Shape, with Rotaflow Stopcock and Interchangeable Stopper

Made of Borosilicate Glass, Thermal expansion 3.3, heat resistant

Product Code	Capacity (ml)	Approx O.D x Height (mm)	Ground Joint Size	Price / Piece	Pack Size	HSN Code
CLS-A155-01	60	50x200	14/15	750.00	10	70179010
CLS-A155-02	125	60x230	19/20	850.00	10	70179010
CLS-A155-03	250	87x300	19/20	980.00	10	70179010
CLS-A155-04	500	107x335	24/25	1250.00	10	70179010
CLS-A155-05	1000	134x390	29/32	1650.00	10	70179010
CLS-A155-06	2000	169x400	29/32	2850.00	10	70179010
CLS-A155-07	3000	185x475	34/35	8950.00	5	70179010
CLS-A155-08	5000	220x510	34/35	11950.00	5	70179010



Funnels, Separating, Pear Shape, with PTFE Stopcock and Interchangeable Stopper

Made of Borosilicate Glass, Thermal expansion 3.3, heat resistant

Product Code	Capacity (ml)	Approx O.D x Height (mm)	Ground Joint Size	Price / Piece	Pack Size	HSN Code
CLS-A156-01	60	50x200	14/15	690.00	10	70179010
CLS-A156-02	125	60x230	19/20	810.00	10	70179010
CLS-A156-03	250	87x300	19/20	920.00	10	70179010
CLS-A156-04	500	107x335	24/25	1250.00	10	70179010
CLS-A156-05	1000	134x390	29/32	1580.00	10	70179010
CLS-A156-06	2000	169x400	29/32	2650.00	10	70179010
CLS-A156-07	3000	185x475	34/35	10500.00	5	70179010
CLS-A156-08	5000	220x510	34/35	14900.00	5	70179010

Funnels, Separating, Pear Shape, with Glass Stopcock and Interchangeable Stopper

Made of Borosilicate Glass, Thermal expansion 3.3, heat resistant

Product Code	Capacity (ml)	Approx O.D x Height (mm)	Ground Joint Size	Price / Piece	Pack Size	HSN Code
CLS-A157-01	60	50x200	14/15	750.00	10	70179010
CLS-A157-02	125	60x230	19/20	940.00	10	70179010
CLS-A157-03	250	87x300	19/20	1050.00	10	70179010
CLS-A157-04	500	107x335	24/25	1350.00	10	70179010
CLS-A157-05	1000	134x390	29/32	1650.00	10	70179010
CLS-A157-06	2000	169x400	29/32	2580.00	10	70179010
CLS-A157-07	3000	185x475	34/35	5600.00	5	70179010
CLS-A157-08	5000	220x510	34/35	10600.00	5	70179010

Funnels, Dropping, Cylindrical, with Rotaflow Stopcock

Made of Borosilicate Glass, Thermal expansion 3.3, heat resistant

Product Code	Capacity (ml)	Socket Size	Price / Piece	Pack Size	HSN Code
CLS-A158-01	25	14 / 23	350.00	10	70179010
CLS-A158-02	60	19 / 26	400.00	10	70179010
CLS-A158-03	125	19 / 26	490.00	10	70179010
CLS-A158-04	250	19 / 26	740.00	10	70179010
CLS-A158-05	500	24 / 29	1080.00	10	70179010
CLS-A158-06	1000	24 / 29	2020.00	10	70179010

Funnels, Dropping, Cylindrical, with PTFE Stopcock

Made of Borosilicate Glass, Thermal expansion 3.3, heat resistant

Product Code	Capacity (ml)	Socket Size	Price / Piece	Pack Size	HSN Code
CLS-A159-01	25	14 / 23	750.00	10	70179010
CLS-A159-02	60	19 / 26	790.00	10	70179010
CLS-A159-03	125	19 / 26	990.00	10	70179010
CLS-A159-04	250	19 / 26	1130.00	10	70179010
CLS-A159-05	500	24 / 29	1490.00	10	70179010
CLS-A159-06	1000	24 / 29	1750.00	10	70179010



Funnels, Dropping, Cylindrical, with Glass Stopcock

Made of Borosilicate Glass, Thermal expansion 3.3, heat resistant

Product Code	Capacity (ml)	Socket Size	Price / Piece	Pack Size	HSN Code
CLS-A160-01	25	14 / 23	390.00	10	70179010
CLS-A160-02	60	19 / 26	590.00	10	70179010
CLS-A160-03	125	19 / 26	650.00	10	70179010
CLS-A160-04	250	19 / 26	510.00	10	70179010
CLS-A160-05	500	24 / 29	1090.00	10	70179010
CLS-A160-06	1000	24 / 29	2285.00	10	70179010

Funnels, Pressure Equalizing, Cylindrical, with PTFE Stopcock

Made of Borosilicate Glass, Thermal expansion 3.3, heat resistant

Product Code	Capacity (ml)	Socket Size	Cone Size	Price / Piece	Pack Size	HSN Code
CLS-A161-01	50	24 / 29	24 / 29	990.00	10	70179010
CLS-A161-02	100	24 / 29	24 / 29	1180.00	10	70179010
CLS-A161-03	500	24 / 29	19 / 26	1350.00	10	70179010
CLS-A161-04	500	24 / 29	24 / 29	2150.00	10	70179010
CLS-A161-05	500	29 / 32	29 / 32	2190.00	10	70179010

Funnels, Pressure Equalizing, Spherical, with PTFE Stopcock

Made of Borosilicate Glass, Thermal expansion 3.3, heat resistant

Product Code	Capacity (ml)	Socket Size	Cone Size	Price / Piece	Pack Size	HSN Code
CLS-A162-01	100	19 / 26	19 / 26	1360.00	10	70179010
CLS-A162-02	100	24 / 29	19 / 26	1540.00	10	70179010
CLS-A162-03	100	24 / 29	24 / 29	1540.00	10	70179010
CLS-A162-04	100	29 / 32	29 / 32	1600.00	10	70179010
CLS-A162-05	500	24 / 29	24 / 29	2340.00	10	70179010
CLS-A162-06	500	24 / 29	29 / 32	2340.00	10	70179010
CLS-A162-07	500	29 / 32	29 / 32	2400.00	10	70179010
CLS-A162-08	500	34 / 35	34 / 35	2500.00	10	70179010

Funnels, Plain, Filter, Long Stem 60

Made of Borosilicate Glass, Thermal expansion 3.3, heat resistant

Product Code	Diameter (mm)	Price / Piece	Pack Size	HSN Code
CLS-A163-01	25	68.00	30	70179010
CLS-A163-02	35	90.00	30	70179010
CLS-A163-03	50	105.00	30	70179010
CLS-A163-04	65	115.00	20	70179010
CLS-A163-05	75	117.00	20	70179010
CLS-A163-06	100	160.00	20	70179010
CLS-A163-07	125	270.00	20	70179010
CLS-A163-08	150	490.00	20	70179010

Funnels, Plain, Powder

Made of Borosilicate Glass, Thermal expansion 3.3, heat resistant

Product Code	Diameter X Height (mm)	Price / Piece	Pack Size	HSN Code
CLS-A164-01	125x116	325.00	20	70179010
CLS-A164-02	150x139	360.00	20	70179010
CLS-A164-03	200x184	980.00	10	70179010
CLS-A164-04	250x217	1380.00	10	70179010



Funnels, Plain, Powder, Stem with Cone

Made of Borosilicate Glass, Thermal expansion 3.3, heat resistant

Product Code	Diameter X Height (mm)	Joint Size	Price / Piece	Pack Size	HSN Code
CLS-A165-01	50x75	19/26	170.00	20	70179010
CLS-A165-02	65x90	19/26	180.00	20	70179010
CLS-A165-03	75x105	24/29	210.00	20	70179010
CLS-A165-04	100x120	24/29	290.00	20	70179010
CLS-A165-05	125x116	24 /29	390.00	20	70179010
CLS-A165-06	150x139	24 /29	410.00	20	70179010
CLS-A165-07	200x184	24 /29	1090.00	4	70179010
CLS-A165-08	250x217	24 /29	1590.00	4	70179010

Tubes, Centrifuge, Conical Bottom, Plain

Made of Borosilicate Glass, Thermal expansion 3.3, heat resistant

Product Code	Capacity (ml)	Approx O.D x Height (mm)	Price / Piece	Pack Size	HSN Code
CLS-A166-01	10	16 x 110	40.00	100	70179010
CLS-A166-02	15	17 x 120	50.00	100	70179010
CLS-A166-03	25	22 x 125	82.00	100	70179010
CLS-A166-04	50	28 x 125	160.00	100	70179010

Tubes, Centrifuge, Conical Bottom, Graduated

Made of Borosilicate Glass, Thermal expansion 3.3, heat resistant

Product Code	Capacity (ml)	Approx O.D x Height (mm)	Price / Piece	Pack Size	HSN Code
CLS-A167-01	10	16 x 110	105.00	30	70179010
CLS-A167-02	15	17 x 120	110.00	30	70179010
CLS-A167-03	25	22 x 125	195.00	20	70179010
CLS-A167-04	50	28 x 125	210.00	20	70179010

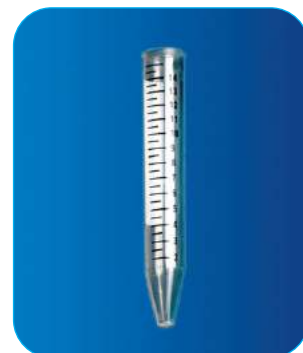
Test Tubes, Round Bottom, Without Rim

Made of Borosilicate Glass, Thermal expansion 3.3, heat resistant

Product Code	Capacity (ml)	Approx O.D x Height (mm)	Price / Piece	Pack Size	HSN Code
CLS-A168-01	3	10 x 75	7.00	800	70179010
CLS-A168-02	5	12 x 75	7.00	800	70179010
CLS-A168-03	7	12 x 100	10.00	800	70179010
CLS-A168-04	13	15 x 125	11.00	800	70179010
CLS-A168-05	15	15 x 150	14.00	800	70179010
CLS-A168-06	27	18 x 150	15.00	400	70179010
CLS-A168-07	38	25 x 100	19.00	200	70179010
CLS-A168-08	55	25 x 150	24.00	200	70179010
CLS-A168-09	70	25 x 200	32.00	100	70179010
CLS-A168-10	100	32 x 200	45.00	50	70179010
CLS-A168-11	170	38 x 200	58.00	50	70179010



Test Tubes, Round Bottom, With Rim

Made of Borosilicate Glass, Thermal expansion 3.3, heat resistant

Product Code	Capacity (ml)	Approx O.D x Height (mm)	Price / Piece	Pack Size	HSN Code
CLS-B168-01	3	10 x 75	7.25	800	70179010
CLS-B168-02	5	12 x 75	7.25	800	70179010
CLS-B168-03	7	12 x 100	10.25	800	70179010
CLS-B168-04	13	15 x 125	11.25	800	70179010
CLS-B168-05	15	15 x 150	14.25	800	70179010
CLS-B168-06	27	18 x 150	15.25	400	70179010
CLS-B168-07	38	25 x 100	19.50	200	70179010
CLS-B168-08	55	25 x 150	24.50	200	70179010
CLS-B168-09	70	25 x 200	32.50	100	70179010
CLS-B168-10	100	32 x 200	45.50	50	70179010
CLS-B168-11	170	38 x 200	58.50	50	70179010

Tubes, Culture, Media, Flat Bottom

Made of Borosilicate Glass, Thermal expansion 3.3, heat resistant

Product Code	Capacity (ml)	Approx O.D x Height (mm)	Price / Piece	Pack Size	HSN Code
CLS-A169-01	5	15 x 75	42.00	100	70179010
CLS-A169-02	10	15 x 125	47.00	100	70179010
CLS-A169-03	15	15 x 150	62.00	100	70179010
CLS-A169-04	20	18 x 125	72.00	100	70179010
CLS-A169-05	25	18 x 150	72.00	100	70179010
CLS-A169-06	30	25 x 100	63.00	100	70179010
CLS-A169-07	45	25 x 150	66.00	50	70179010
CLS-A169-08	60	25 x 200	67.00	50	70179010
CLS-A169-09	100	32 x 200	120.00	50	70179010

Tubes, Culture, Media, Round Bottom

Made of Borosilicate Glass, Thermal expansion 3.3, heat resistant

Product Code	Capacity (ml)	Approx O.D x Height (mm)	Price / Piece	Pack Size	HSN Code
CLS-A169-01	5	15 x 75	42.00	100	70179010
CLS-A169-02	10	15 x 125	47.00	100	70179010
CLS-A169-03	15	15 x 150	62.00	100	70179010
CLS-A169-04	20	18 x 125	72.00	100	70179010
CLS-A169-05	25	18 x 150	72.00	100	70179010
CLS-A169-06	30	25 x 100	63.00	100	70179010
CLS-A169-07	45	25 x 150	66.00	50	70179010
CLS-A169-08	60	25 x 200	67.00	50	70179010
CLS-A169-09	100	32 x 200	120.00	50	70179010

Pipettes, Transfer, Volumetric

Made of Borosilicate Glass, Thermal expansion 3.3, heat resistant

Product Code	Capacity (ml)	Tolerance \pm ml	Price / Piece	Pack Size	HSN Code
CLS-A171-01	1	0.015	132.00	10	70179010
CLS-A171-02	2	0.02	132.00	10	70179010
CLS-A171-03	5	0.03	138.00	10	70179010
CLS-A171-04	10	0.04	160.00	10	70179010
CLS-A171-05	20	0.06	180.00	10	70179010
CLS-A171-06	25	0.06	185.00	10	70179010
CLS-A171-07	50	0.10	235.00	10	70179010
CLS-A171-08	100	0.15	350.00	10	70179010



Pipettes, Graduated,

Made of Borosilicate Glass, Thermal expansion 3.3, heat resistant

Product Code	Capacity (ml)	Tolerance \pm ml	Price / Piece	Pack Size	HSN Code
CLS-A172-01	0.1	0.01	130.00	20	70179010
CLS-A172-02	0.2	0.01	130.00	20	70179010
CLS-A172-04	1	0.10	128.00	20	70179010
CLS-A172-05	2	0.10	135.00	20	70179010
CLS-A172-06	5	0.05	140.00	20	70179010
CLS-A172-07	10	0.10	150.00	20	70179010
CLS-A172-09	25	0.20	240.00	20	70179010

Beakers, Low Form, with Spout, Graduated

Made of Borosilicate Glass, Thermal expansion 3.3, heat resistant

Product Code	Capacity (ml)	Approx O.D x Height (mm)	Price / Piece	Pack Size	HSN Code
CLS-A173-01	5	22 x 30	80.00	20	70179010
CLS-A173-02	10	26 x 35	82.00	20	70179010
CLS-A173-03	25	34 x 50	84.00	60	70179010
CLS-A173-04	50	42 x 60	60.00	60	70179010
CLS-A173-05	100	50 x 70	65.00	40	70179010
CLS-A173-06	150	55 x 80	65.00	40	70179010
CLS-A173-07	250	68 x 95	68.00	40	70179010
CLS-A173-08	400	80 x 110	115.00	40	70179010
CLS-A173-09	500	83 x 115	116.00	40	70179010
CLS-A173-10	600	90 x 125	140.00	40	70179010
CLS-A173-11	1000	105 x 145	230.00	20	70179010
CLS-A173-12	2000	131 x 185	470.00	6	70179010
CLS-A173-13	3000	150 x 210	1210.00	4	70179010
CLS-A173-14	5000	170 x 270	1750.00	4	70179010
CLS-A173-15	10000	220 x 350	5650.00	1	70179010

Beakers Tall Form with Spout Graduated

Made of Borosilicate Glass, Thermal expansion 3.3, heat resistant

Product Code	Capacity (ml)	Approx O.D x Height (mm)	Price / Piece	Pack Size	HSN Code
CLS-A174-01	25	36 x 70	110.00	40	70179010
CLS-A174-02	50	38 x 70	120.00	40	70179010
CLS-A174-03	100	48 x 80	120.00	40	70179010
CLS-A174-04	150	54 x 95	125.00	40	70179010
CLS-A174-05	250	60 x 120	122.00	40	70179010
CLS-A174-06	500	77 x 137	165.00	20	70179010
CLS-A174-07	1000	95 x 180	320.00	20	70179010

Flasks, Kjeldahl, Round Bottom, Long Neck

Made of Borosilicate Glass, Thermal expansion 3.3, heat resistant

Product Code	Capacity (ml)	Approx O.D x Height (mm)	Price / Piece	Pack Size	HSN Code
CLS-A175-01	100	58 x 240	160.00	10	70179010
CLS-A175-02	300	81 x 290	270.00	10	70179010
CLS-A175-03	500	100 x 325	540.00	10	70179010
CLS-A175-04	800	115 x 350	650.00	10	70179010



Flasks, Kjeldahl, Round Bottom, Long Neck with Interchangeable Joint

Made of Borosilicate Glass, Thermal expansion 3.3, heat resistant

Product Code	Capacity (ml)	Interchangeable Joint	Price / Piece	Pack Size	HSN Code
CLS-A176-01	100	24 / 29	290.00	10	70179010
CLS-A176-02	300	24 / 29	330.00	10	70179010
CLS-A176-03	500	24 / 29	650.00	10	70179010
CLS-A176-04	800	24 / 29	750.00	10	70179010

Flasks, Distilling, With Side Arm

Made of Borosilicate Glass, Thermal expansion 3.3, heat resistant

Product Code	Capacity (ml)	Approx O.D x Height (mm)	Price / Piece	Pack Size	HSN Code
CLS-A177-01	100	65 x 215	200.00	4	70179010
CLS-A177-02	125	68 x 214	220.00	4	70179010
CLS-A177-03	250	85 x 226	255.00	4	70179010
CLS-A177-04	500	105 x 240	340.00	4	70179010
CLS-A177-05	1000	130 x 305	470.00	4	70179010
CLS-A177-06	2000	170 x 318	680.00	4	70179010

Desiccators with Cover, Die Pressed, With Porcelain Plate

Made of Borosilicate Glass, Thermal expansion 3.3, heat resistant

Product Code	Approx ID Ground Flange (mm)	Price / Piece	Pack Size	HSN Code
CLS-A178-01	100	5500.00	1	70179010
CLS-A178-02	150	6500.00	1	70179010
CLS-A178-03	200	8500.00	1	70179010
CLS-A178-04	250	11900.00	1	70179010
CLS-A178-05	300	16500.00	1	70179010

Vacuum Desiccators with Cover, With Stopcock

Made of Borosilicate Glass, Thermal expansion 3.3, heat resistant

Product Code	Approx ID Ground Flange (mm)	Price / Piece	Pack Size	HSN Code
CLS-A179-01	100	8500.00	1	70179010
CLS-A179-02	150	13500.00	1	70179010
CLS-A179-03	200	14500.00	1	70179010
CLS-A179-04	250	20500.00	1	70179010
CLS-A179-05	300	25900.00	1	70179010

Weighing Scoops, With Open Tubular Arm

Made of Borosilicate Glass, Thermal expansion 3.3, heat resistant

Product Code	Capacity (ml)	Price / Piece	Pack Size	HSN Code
CLS-A180-01	3	175.00	10	70179010
CLS-A180-02	6	175.00	10	70179010
CLS-A180-03	10	220.00	10	70179010

 Speak to our expert
+91-120-4968617

Tubes, Melting, (Thiele Tube)

Made of Borosilicate Glass, Thermal expansion 3.3, heat resistant

Product Code	Side Tube (mm)	Approx O.D x Height (mm)	Price / Piece	Pack Size	HSN Code
CLS-A181-01	10	18 x 150	160.00	10	70179010
CLS-A181-02	10	25 x 150	200.00	10	70179010

Bottles, Wash, Complete with Interchangeable Stopper

Made of Borosilicate Glass, Thermal expansion 3.3, heat resistant

Product Code	Capacity (ml)	Interchangeable Stopper	Price / Piece	Pack Size	HSN Code
CLS-A182-01	250	24 / 29	550.00	5	70179010
CLS-A182-02	500	24 / 29	720.00	5	70179010
CLS-A182-03	1000	24 / 29	910.00	5	70179010

Cylindrical Borosilicate Glass container

Made of Borosilicate Glass, Thermal expansion 3.3, heat resistant

Product Code	Approx O.D x Height (mm)	Cap.	Price / Piece	Pack Size	HSN Code
CLS-A185-01	70 x 40	100 ml	480.00	10	70179010
CLS-A185-02	80 x 45	150 ml	560.00	10	70179010
CLS-A185-03	95 x 55	300 ml	600.00	10	70179010
CLS-A185-04	100 x 50	300 ml	740.00	10	70179010
CLS-A185-05	150 x 75	1000 ml	1800.00	4	70179010
CLS-A185-06	190 x 100	2000 ml	2600.00	4	70179010

Borosilicate Glass Bowl container

Made of Borosilicate Glass, Thermal expansion 3.3, heat resistant

Product Code	Approx O.D x Height (mm)	Capacity (ml)	Price / Piece	Pack Size	HSN Code
CLS-A186-01	80 x 45	80 ml	560.00	10	70179010
CLS-A186-02	95 x 55	170 ml	680.00	10	70179010
CLS-A186-03	105 x 55	250 ml	720.00	10	70179010
CLS-A186-04	150 x 80	1000 ml	1800.00	4	70179010
CLS-A186-05	200 x 100	2000 ml	2550.00	4	70179010

Jar

Made of Borosilicate Glass, Thermal expansion 3.3, heat resistant

Product Code	Approx O.D x Height (mm)	Capacity (ml)	Price / Piece	Pack Size	HSN Code
CLS-A187-01	68 x 65	150 ml	144.00	10	70179010
CLS-A187-02	68 x 120	300 ml	180.00	10	70179010
CLS-A187-03	83 x 100	400 ml	270.00	10	70179010



Cylindrical Glass Container With Plastic Cap

Made of Borosilicate Glass, Thermal expansion 3.3, heat resistant

Product Code	Approx O.D x Height (mm)	Capacity (ml)	Price / Piece	Pack Size	HSN Code
CLS-A188-01	100 x 50	300 ml	540.00	10	70179010
CLS-A188-02	83 x 100	400 ml	380.00	10	70179010

Distillation Apparatus, with Electrically Heated, All Glass Complete, with stand clamp switch board

Made of Borosilicate Glass, Thermal expansion 3.3, heat resistant

Product Code	Flask Cap.	Price / Piece Single	Price / Piece Double	Price / Piece Triple	Pack Size	HSN Code
CLS-A101-01	3 Ltr	15,000.00	30,000.00	46,500.00	1	70179010
CLS-A101-02	5 Lts	18,000.00	32,500.00	48,500.00	1	70179010
CLS-A101-03	10 Ltr	24,500.00	45,000.00	64,500.00	1	70179010

Spare Flask

Product Code	Capacity	Price / Piece	Pack Size	HSN Code
CLS-A101-04	3 Ltr	5,500.00	1	70179010
CLS-A101-05	5 Lts	7,500.00	1	70179010
CLS-A101-06	10 Ltr	11,500.00	1	70179010
CLS-A101-07	Autocut Charge Extra	3,500.00	1	70179010

Spare Condensor

Product Code	Capacity	Price / Piece	Pack Size	HSN Code
CLS-A101-08	3 Ltr	4,500.00	1	70179010
CLS-A101-09	5 Lts	6,000.00	1	70179010
CLS-A101-10	10 Ltr	7,000.00	1	70179010

Cylinders, Nessler, Colour Comparison, Graduated

Made of Borosilicate Glass, Thermal expansion 3.3, heat resistant

Product Code	Capacity (ml)	Approx O.D x Height (mm)	Price / Piece	Pack Size	HSN Code
CLS-A170-01	50	26 x 150	155.00	20	70179010
CLS-A170-02	100	34 x 180	230.00	30	70179010

Flasks, Culture Haffkine

Made of Borosilicate Glass, Thermal expansion 3.3, heat resistant

Product Code	Capacity (ml)	Price / Piece	Pack Size	HSN Code
CLS-A102-01	3000	5,600.00	4	70179010
CLS-A102-02	4000	6,600.00	4	70179010



CLS LABORATORY GLASSWARE

CLS GLASSWARE

Made from finest Borosilicate glass (except a few products), at some of the best manufacturing facilities. A wide range of common lab requisites.

- Meets International specifications.
- High Chemical resistance
- Certified weights and validated methods used.
- High resistance to thermal shock.
- Exceptional optical clarity
- Wide range from lab size to custom size.

TECHNICAL DATA ON CLS GLASSWARE

Touff Glasswares are manufactured using low expansion 3.3 for borosilicate glass, characterized by their high heat-resistance and chemical stability.

Because of its properties, this glass is used in situations which place the highest demands on the heat-resistance and chemical stability of products as well as their neutrality with respect to the substances or preparations with which they come into contact, i.e. in Chemistry, Petro chemistry, the Food, Energy and metal working industries, health care, Microbiology, Pharmacy, Mechanical Engineering and Laboratories.

The Glass used in manufacturing CLS Glassware are smooth, non-porous and perfectly transparent with no catalytic action, and are corrosion-resistant even in demanding operating conditions upto 300°C without sudden changes of temperature. CLS Glassware is an environment-friendly product and is completely harmless from an ecological point of view.

CHEMICAL COMPOSITION OF GLASS USED IN MANUFACTURING CLS GLASSWARE.

Component	Amount (% by Weight)
SiO ₂	80.0
B ₂ O ₃	13.2
Al ₂ O ₃	2.5
Na ₂ O + K ₂ O	4.3

CHEMICAL PROPERTIES OF CLS

CLS glasswares are chemically stable, practically inert and characterised by high resistance to the effects of water, water vapour, acids, salt solutions and relatively high resistance to alkalis.

The glass is etched by Hydrofluoric acid and concentrated Trihydrogen Phosphoric acid and corroded by hot concentrated alkaline solutions. Constant alternation of acid and alkaline environment increased corrosion.

PHYSICAL PROPERTIES OF CLS GLASSWARE

The physical properties of CLS glassware as shown in the following table comply with the ISO 3585 and CSN ISO 3585 standards.

Mean coefficient of linear thermal expansion (ISO 7991) $3.3 \times 10^{-6} \text{ } ^\circ\text{C}$. Temperatures of main points in terms of Viscosity η in dPa x s



Working Temperature1250°C
Softening Point - Littelton Point800.°C
Upper cooling temperature550°C
Lower cooling temperature500°C
Transformation temperature515°C

Borosilicate glass 3.3 for laboratory glassware is suitable for use in microwaves. Wherever laboratory glassware is not subjected to the highest thermal demands soda-lime-glass is used. This glass possesses good chemical and physical properties and is normally well suited to short - term exposure to chemical agents.

For your safety:

Glass is an environmentally friendly material. It is made from natural raw material sand, calcium carbonate and sodium carbonate. None of these substances have an adverse effect on either human beings or their surroundings. Glass can be reused and disposed off without any problems. In order for you to make safe and full use of its many advantages when working with glass instruments and components, you should take notice of several special features of their materials:

- Always work according to the normal laboratory safety rules and, if applicable, according to the manufacturer's instructions.
- Check each time you have received goods and before starting work that the glassware is undamaged.
- Assemble glass instruments and apparatus stress-free, because apparatus which is already under stress when it is assembled can fail during operation.
- Do not allow glass apparatus to be subjected to any sudden mechanical stress. Make sure that forces or stresses are only applied slowly and ensure slow stress compensation.
- Do not subject glassware to abrupt changes in temperature. Glass reacts extremely sensitively to such stress. Please note that the stronger the wall thickness of the glass, the more sensitively it reacts.
- The mechanical stability of glass is determined to a great degree by the condition of its surface. Nicks and scratches which occur during normal use, considerably reduce the theoretical stability.
- Glass instruments or components which are permanently under pressure should be repeatedly inspected for damage. Glasses which are already damaged should never be subjected to pressure or vacuum.
- Always wear protective glasses and gloves or protective clothing when either of the tasks or its use for resulting substances make this necessary.

For your information :

The dimension given in the brochure are nominal dimension without any tolerances. If standards have been mentioned then the dimension and sizes are in accordance with these. In all other cases, the dimensional tolerances of the CLS manufacturing plant apply.

- The illustrations are non-binding.
- With the appearance of this catalogue, previous editions are no longer valid.
- Axiva reserves the right to make technical and standard-related alterations.
- Touff articles for which standard pack quantities are given can only be supplied in these quantities.
- We will confirm your order according to the current version of our General Terms and Conditions.
- Equipments used for calibration of volumetric glassware are traceable to Indian National Standards.

Retort Stand

Non-corrosive, moulded Retort Stands provide excellent replacement for the metal ones. Even the metallic rod has a polypropylene covering making it non- corrosive. The rod measuring 12.5 mm x 750 mm can be screwed into the heavy base giving way to a perfectly stable Retort Stand. Material : Polystyrene/ Polypropylene

Cat. No.	Size	Pcs/Pack	Price / Pack	HSN Code
CLS-117-01	225 x 150 mm- Side Hold	1	590.00	6903
CLS-117-02	300 x 200 mm-Center Hold	1	975.00	6903
CLS-117-03	300 x 200 mm- Side Hold	1	975.00	6903



Retort Stand

Material : M.S & Blue Powder Coated Rod with L- Key AS PER DIN 12892

Cat. No.	Size	Size (Length x dia)	Pcs/Pack	Price / Pcs	HSN Code
CLS-309-01	150 x 100mm	500mm x 12mm	2	610.00	6903
CLS-309-02	200 x 125mm	600mm x 12mm	2	840.00	6903
CLS-309-03	250 x 150mm	750mm x 12mm	2	1150.00	6903



Retort Stand

Material : Cast Iron & Hammer tone rod with L- Key AS PER DIN 12892

Cat. No.	Size	Size (Length x dia)	Pcs/Pack	Price / Pcs	HSN Code
CLS-310-01	150 x 100 mm	950 x 10 mm	2	510.00	6903
CLS-310-02	175 x 125 mm	600 x 12.5 mm	2	605.00	6903
CLS-310-03	200 x 125mm	600 x 12.5 mm	2	650.00	6903
CLS-310-04	200 x 125mm	600 x 12 mm	2	705.00	6903
CLS-310-05	225 x 150mm	750 x 12 mm	2	1110.00	6903
CLS-310-06	250 x 150mm	600 x 12 mm	2	1310.00	6903
CLS-310-07	250 x 200mm	750 x 12 mm	2	1690.00	6903
CLS-310-08	300 x 175mm	900 x 12 mm	2	1870.00	6903
CLS-310-09	250 x 150mm	750 x 12 mm	2	1410.00	6903

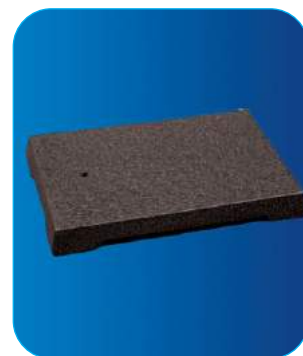

Retort Rings

Material : Mild Steel, Hammer Tone Painted, with Boss Head

Cat. No.	Size	Pcs/Pack	Price / Pack	HSN Code
CLS-313-01	50 mm	4	165.00	6903
CLS-313-02	62.5mm	4	165.00	6903
CLS-313-03	75mm	4	185.00	6903
CLS-313-04	100mm	4	186.00	6903
CLS-313-05	125mm	2	205.00	6903
CLS-313-06	150mm	2	209.00	6903
CLS-313-07	200mm	2	215.00	6903



Retort Ring

Made of steel, chrome plated. With rod from 70 mm to 220 mm length or With boss head to suit rod dia of 14 mm

Cat. No.	L	Ø	Type	Pcs/Pack	Price / Pack	HSN Code
CLS-393-01	160 mm	50mm	Rod	4	222.00	6903
CLS-393-02	200 mm	70mm	Rod	4	236.00	6903
CLS-393-03	220 mm	100mm	Rod	4	270.00	6903
CLS-393-04	220 mm	120mm	Rod	2	302.00	6903
CLS-393-05	220 mm	140mm	Rod	2	280.00	6903
CLS-393-06	70 mm	50mm	Bosshead	4	260.00	6903
CLS-393-07	70 mm	70mm	Bosshead	4	246.00	6903
CLS-393-08	70 mm	100mm	Bosshead	4	306.00	6903
CLS-393-09	70 mm	120mm	Bosshead	2	332.00	6903
CLS-393-10	70 mm	140mm	Bosshead	2	360.00	6903



Retort Clamp

Cross pattern, die-casted, to hold upto 65 mm AS PER DIN 12894

Cat. No.	Type	Pcs/Pack	Price / Pack	HSN Code
CLS-324-01	Aluminium, Cork Lined - Cross Pattern,	2	320.00	6903
	to hold upto 50 - 65 mm circles			
CLS-324-04	Zinc, Cork Lined - Cross Pattern,	2	300.00	6903
	to hold upto 50 - 65 mm circles			



Retort Clamp

Material : M.S & Blue Powder Coated Rod with L- Key AS PER DIN 12892

Cat. No.	Type	Pcs/Pack	Price / Pack	HSN Code
CLS-326-02	Three Prongs, to hold upto 50 - 65 mm circles	2	344.00	6903



Universal Clamp

Aluminium, Cork Lined, AS PER DIN 12894, Material : Aluminium diecasted, powder coated, chrome plated with MS Steel Rod

Cat. No.	Type	Pcs/Pack	Price / Pack	HSN Code
CLS-328-01	to hold upto 50 - 65 mm circles	2	335.00	6903



Speak to our expert
+91-120-4968617

Condenser Clamp - Four Prong

Silicone Sleeved, Material: Aluminium, powder coated with steel rod

Cat. No.	Type	Pcs/Pack	Price / Pack	HSN Code
CLS-334-02	to hold upto 125 mm circles	2	830.00	6903



Condenser Clamp - Three Prong

Silicone Sleeved, Material: Aluminium, powder coated with steel rod

Cat. No.	Type	Pcs/Pack	Price / Pack	HSN Code
CLS-335-02	to hold upto 125 mm circles	2	835.00	6903



Retort Clamp

Three Prong, EURO DESIGN

Cat. No.	Type	Type	Price / Pack	HSN Code
CLS-390-01	PVC sleeve with rod	2	400.00	6903
CLS-390-02	Silicone sleeve with rod	2	425.00	6903
CLS-390-03	PVC sleeve with boss Head	2	525.00	6903
CLS-390-04	SILICONE sleeve with boss Head	2	560.00	6903



Retort Clamp

Two Prong Standard, EURO DESIGN, Zinc alloy, Chrome plated to hold upto 80 mm

Cat. No.	Type	Pcs/Pack	Price / Pack	HSN Code
CLS-391-01	CORK lined with rod	2	415.00	6903
CLS-391-02	PVC sleeve with rod	2	418.00	6903
CLS-391-03	SILICONE sleeve with rod	2	418.00	6903
CLS-391-04	CORK lined with boss head	2	520.00	6903
CLS-391-05	PVC sleeve with boss head	2	520.00	6903
CLS-391-06	SILICONE sleeve with boss head	2	545.00	6903



BOSS HEAD

Material : Cast Iron, painted, for use retort Stand and Condenser Clamp AS PER DIN 12895

Cat. No.	Size (Dia x Length)	Pcs/Pack	Price / Pack	HSN Code
CLS-337-01	hold upto 25mm heavy, with round screw	4	360.00	6903
CLS-337-02	hold upto 25mm heavy, with thumb screw	4	360.00	6903
CLS-337-03	hold upto 25mm heavy, with rod screw	4	360.00	6903
CLS-338-01	hold upto 20mm heavy with round screw	4	205.00	6903
CLS-338-03	hold upto 20mm heavy with rod screw	4	205.00	6903



BOSS HEAD

Material : Powder coated, AS PER DIN 12895

Cat. No.	Description	Pcs/Pack	Price / Pack	HSN Code
CLS-341-01	Aluminium, Round Screw, hold upto 16 mm AS PER DIN 12895	4	160.00	6903
CLS-341-02	Aluminium, Thumb Screw, hold upto 16 mm AS PER DIN 12895	4	156.00	6903
CLS-341-03	Aluminium, Rod Screw, hold upto 16 mm AS PER DIN 12895	4	158.00	6903
CLS-341-04	Zinc, Round Screw, hold upto 16 mm AS PER DIN 12895	4	136.00	6903
CLS-341-05	Zinc, Thumb Screw, hold upto 16 mm AS PER DIN 12895	4	152.00	6903
CLS-341-06	Zinc, Rod Screw, hold upto 16 mm AS PER DIN 12895	4	158.00	6903

Tripod Stand

Material : Cast iron base, Hammer Tone, Finished Round

Cat. No.	Size	Top	Pcs/Pack	Price / Pcs	HSN Code
CLS-344-01	100 x 150 mm	with round top	1	210.00	6903
CLS-344-02	100 x 175 mm	with round top	1	220.00	6903
CLS-344-03	100 x 200 mm	with round top	1	230.00	6903
CLS-344-04	125 x 150 mm	with round top	1	230.00	6903
CLS-344-05	125 x 175 mm	with round top	1	240.00	6903
CLS-344-06	125 x 200 mm	with round top	1	240.00	6903
CLS-344-07	100 x 150 mm	with triangle top	1	205.00	6903
CLS-344-08	100 x 175 mm	with triangle top	1	210.00	6903
CLS-344-09	100 x 200 mm	with triangle top	1	220.00	6903
CLS-344-10	125 x 150 mm	with triangle top	1	240.00	6903
CLS-344-11	125 x 175 mm	with triangle top	1	235.00	6903
CLS-344-12	125 x 200 mm	with triangle top	1	245.00	6903

Burette Clamp

 Made of Aluminium, die casted, blue painted, black rubber sleeves for firm gripping of buret tes.
 With adjustable clamps to hold upto 30 mm, spring type, thumb screw key for retort rods upto 16 mm dia.

Cat. No.	Type	Pcs/Pack	Price / Pcs	HSN Code
CLS-394-01	Single	12	570.00	6903
CLS-394-02	Double	6	510.00	6903

Burette Clamp, Mild Steel, Single

Material : Mild Steel, Chrome Plated, Fisher Type with Boss Head, Single.

Cat. No.	Type	Max. Temp.	Pcs/Pack	Price / Pcs	HSN Code
CLS-318-01	PVC Sleeve	80°C	12	250.00	6903
CLS-318-02	Silicon Sleeve	280°C	12	255.00	6903



Burette Clamp, Mild Steel, Single

Material : Mild Steel, Black Powder Coated, Fisher Type with Boss Head, Single.

Cat. No.	Type	Max. Temp.	Pcs/Pack	Price / Pcs	HSN Code
CLS-319-01	PVC Sleeve	80°C	12	235.00	6903
CLS-319-02	Silicon Sleeve	280°C	12	230.00	6903

Burette Clamp, Mild Steel, Double

Material : Mild Steel, Chrome Plated, Fisher Type with Boss Head, Double

Cat. No.	Type	Max. Temp.	Pcs/Pack	Price / Pcs	HSN Code
CLS-320-01	PVC Sleeve	80°C	6	380.00	6903
CLS-320-02	Silicon Sleeve	280°C	6	375.00	6903

Burette Clamp, Mild Steel

Material : Mild Steel, Powder Coated, Fisher Type with Boss Head, Double

Cat. No.	Type	Max. Temp.	Pcs/Pack	Price / Pcs	HSN Code
CLS-321-01	PVC Sleeve	80°C	6	365.00	6903
CLS-321-02	Silicon Sleeve	280°C	6	360.00	6903

Wire Gauge

Ceramic Center, Maximum Temperature Upto 800°C

Cat. No.	Type	Pcs/Pack	Price / Pcs	HSN Code
CLS-524-01	100 x 100 mm	10	55.00	6903
CLS-524-02	125 x 125 mm	10	60.00	6903
CLS-524-03	150 x 150 mm	10	64.00	6903
CLS-524-04	200 x 200 mm	10	98.00	6903

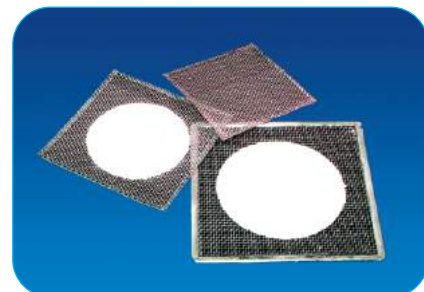
Bunsen Burner

With Stop Cock L.P.G.

Cat. No.	Description	Pcs/Pack	Price / Pack	HSN Code
CLS-347-01	Casted Iron painted AS PER DIN 30665	1	505.00	6903
CLS-347-02	Casted Iron painted, easy flame regulator double walled	1	545.00	6903
Brass pipe to give a concentrated higher flame, Eco-Friendly				
AS PER DIN 30665				

Meaker Burner

Material : Casted Iron painted AS PER DIN 30665

Cat. No.	Description	Pcs/Pack	Price / Pack	HSN Code
CLS-348-01	With Stop Cock	1	910.00	6903



Meaker Burner

Material : Casted Iron painted AS PER DIN 30665

Cat. No.	Description	Pcs/Pack	Price / Pack	HSN Code
CLS-349-01	With Stop Cock L.P.G	1	1125.00	6903
CLS-349-02	ECONOMIC With Stop Cock L.P.G, Bunsen	1	1075.00	6903
Burner type with cap, for school purpose				

Laboratory Jack

All sizes are in millimeters

Cat No.	Type	Size (mm)	Pcs/Pack	Price / Pack	HSN Code
CLS-370-09	Stainless Steel	120 x 140	1	4210.00	6903
CLS-370-10	Stainless Steel	200 x 200	1	6810.00	6903
CLS-370-11	Stainless Steel	250 x 250	1	9210.00	6903

Silica Crucible

With Lid Upto 1000°C

Cat. No.	Capacity	Dia (mm)	Height (mm)	Pcs/Pack	Price / Pcs	HSN Code
CLS-518-01	15	41	25	6	690.00	6903
CLS-518-02	25	47	28	6	770.00	6903
CLS-518-03	50	57	37	6	1350.00	6903
CLS-518-04	80	67	45	4	2250.00	6903
CLS-518-05	100	71	50	4	2800.00	6903
CLS-518-06	150	82	51	4	3250.00	6903

Silica Crucible

Without Lid Upto 1000°C

Cat. No.	Capacity	Dia (mm)	Height (mm)	Pcs/Pack	Price / Pcs	HSN Code
CLS-519-01	15	41	25	6	340.00	6903
CLS-519-02	25	47	28	6	370.00	6903
CLS-519-03	50	57	37	6	740.00	6903
CLS-519-04	80	67	45	4	1260.00	6903
CLS-519-05	100	71	50	4	1600.00	6903
CLS-519-06	150	82	51	4	1950.00	6903

Quartz Crucible

Made of Quartz Gel & Powder, Tolerance upto 2000°C

Cat. No.	Size	Type	Pcs/Pack	Price / Pcs	HSN Code
CLS-521-01	15 ML	Without Lid	4	680.00	7017
CLS-521-02	25 ML	Without Lid	4	760.00	7017
CLS-521-03	50 ML	Without Lid	2	1190.00	7017
CLS-521-04	100 ML	Without Lid	2	2290.00	7017
CLS-521-05	15 ML	With Lid	4	1170.00	7017
CLS-521-06	25 ML	With Lid	4	1310.00	7017
CLS-521-07	50 ML	With Lid	2	1870.00	7017
CLS-521-08	100 ML	With Lid	2	3650.00	7017



Crucible Porcelain (Euro Design)

Made of Ceramic With Lid Maximum temperature upto 1150°C

Cat. No.	Capacity	Dia	Height	Pcs/Pack	Price / Pcs	HSN Code
CLS-522-13	2 ml	18 mm	12 mm	6	105.00	6903
CLS-522-14	8 ml	32 mm	20 mm	6	115.00	6903
CLS-522-15	17 ml	41 mm	26 mm	4	140.00	6903
CLS-522-16	30 ml	50 mm	31 mm	4	165.00	6903
CLS-522-17	50 ml	61 mm	37 mm	4	200.00	6903
CLS-522-18	100 ml	76 mm	46 mm	2	305.00	6903
CLS-522-19	150 ml	84 mm	52 mm	2	350.00	6903
CLS-522-20	250 ml	102 mm	60 mm	2	480.00	6903

Crucible Porcelain, Tall form (Euro Design)

Made of Ceramic With Lid Tall Form Maximum temperature upto 1150°C

Cat. No.	Capacity	Dia	Height	Pcs/Pack	Price / Pcs	HSN Code
CLS-523-11	1.5 ml	15 mm	15 mm	6	105.00	6903
CLS-523-12	6 ml	24 mm	20 mm	6	115.00	6903
CLS-523-13	10 ml	31 mm	26 mm	4	120.00	6903
CLS-523-14	15 ml	35 mm	29 mm	4	140.00	6903
CLS-523-15	30 ml	43 mm	37 mm	4	165.00	6903
CLS-523-16	40 ml	50 mm	40 mm	2	185.00	6903
CLS-523-17	50 ml	53 mm	43 mm	2	220.00	6903
CLS-523-18	100 ml	65 mm	54 mm	2	300.00	6903
CLS-523-19	250 ml	88 mm	72 mm	2	450.00	6903

Crucible Tong, SS

Stainless Steel. Grade 304

Cat. No.	Size (mm)	Pcs/Pack	Price / Pcs	HSN Code
CLS-355-01	150	4	140.00	6903
CLS-355-02	200	4	180.00	6903
CLS-355-03	250	4	270.00	6903
CLS-355-04	300	4	330.00	6903
CLS-355-05	375	4	450.00	6903
CLS-355-06	450	4	530.00	6903
CLS-355-07	600	4	1150.00	6903

Crucible Tong, Mild Steel

Made of mild steel, black paint/chrome plated.

Cat. No.	Size (mm)	Type	Pcs/Pack	Price / Pcs	HSN Code
CLS-367-01	150	black painted	4	120.00	6903
CLS-367-02	200	black painted	4	130.00	6903
CLS-367-03	300	black painted	4	260.00	6903
CLS-367-04	150	chrome plated	4	130.00	6903
CLS-367-05	200	chrome plated	4	140.00	6903
CLS-367-06	300	chrome plated	4	245.00	6903

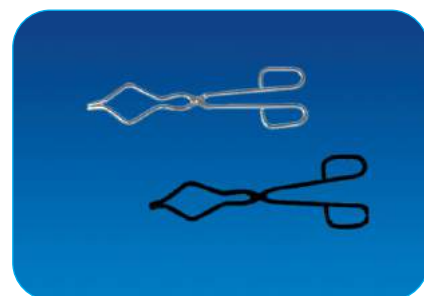

Evaporating Dish, EURO DESIGN

Made of Porcelain, maximum temperature upto 1000°C

Cat No.	Capacity	OD x H	Pcs/Pack	Price / Pcs	HSN Code
CLS-528-07	35 ML	60 x 24 mm	6	110.00	6903
CLS-528-08	70 ML	75 x 30 mm	6	125.00	6903
CLS-528-09	80 ML	80 x 30 mm	6	130.00	6903
CLS-528-10	120 ML	94 x 42 mm	6	140.00	6903
CLS-528-11	150 ML	100 x 42 mm	6	150.00	6903
CLS-528-12	250 ML	115 x 45 mm	4	160.00	6903
CLS-528-13	385 ML	145 x 48 mm	4	390.00	6903
CLS-528-14	525 ML	162 x 51 mm	2	590.00	6903
CLS-528-15	765 ML	185 x 54 mm	2	1220.00	6903
CLS-528-16	1285 ML	215 x 75 mm	2	1540.00	6903
CLS-528-17	2100 ML	265 x 80 mm	1	1750.00	6903
CLS-528-18	3250 ML	305 x 95 mm	1	3590.00	6903

Pestle & Mortar, EURO DESIGN

Made of Porcelain, maximum temperature up to 1000°C

Cat. No.	Size (ID x H)	Pcs/Pack	Price / Pcs	HSN Code
CLS-529-08	60 x 44 mm	6	190.00	6903
CLS-529-09	75 x 48 mm	4	210.00	6903
CLS-529-10	85 x 55 mm	4	250.00	6903
CLS-529-11	100 x 70 mm	4	350.00	6903
CLS-529-12	117 x 75 mm	4	475.00	6903
CLS-529-13	125 x 88 mm	2	430.00	6903
CLS-529-15	150 x 100 mm	1	680.00	6903
CLS-529-16	175 x 115 mm	1	1410.00	6903
CLS-529-17	200 x 140 mm	1	1510.00	6903
CLS-529-18	250 x 175 mm	1	5950.00	6903
CLS-529-19	300 x 205 mm	1	7150.00	6903
CLS-529-20	350 mm ID	1	14750.00	6903
CLS-529-21	400 mm ID	1	21950.00	6903

Rubber Tubing

Material : Natural Rubber, Temperature range -30 to 70°C Red Superior 10 Meter Coil

Cat. No.	Bore	Wall Thickness	Pcs/Pack	Price / Pack	HSN Code
CLS-406-01	4.0 mm	1.0 mm	10 Mtr	240.00	6903
CLS-406-02	5.0 mm	1.5 mm	10 Mtr	320.00	6903
CLS-406-03	6.0 mm	1.5 mm	10 Mtr	380.00	6903
CLS-406-04	7.0 mm	1.5 mm	10 Mtr	460.00	6903
CLS-406-05	8.0 mm	1.5 mm	10 Mtr	530.00	6903
CLS-406-06	9.0 mm	2.0 mm	10 Mtr	650.00	6903
CLS-406-07	10.0 mm	2.0 mm	10 Mtr	710.00	6903
CLS-406-08	12.0 mm	2.5 mm	10 Mtr	920.00	6903

Dissecting Set

Cat. No.	Description	Pcs/Pack	Price / Pack	HSN Code
CLS-536-01	Made of Stainless Steel, Instruments are Dressing Scissor, Cuticle Scissor, Dressing Forceps, Dissecting Forceps, Flapper, Seeker, Arrow Needle, Needle, Blow Pipe, B.P. Handle with Scalpel Blade, Dropper, Chain Hook, Scalpels, Magnifier Lense.	1 set	790.00	6903



Forceps

Stainless Steel straight fine points, 410 SS Grade

Cat. No.	Size	Pcs/Pack	Price / Pcs	HSN Code
CLS-531-01	100 mm	10	44.00	6903
CLS-531-02	125 mm	10	60.00	6903
CLS-531-03	150 mm	10	72.00	6903
CLS-531-04	200 mm	10	96.00	6903
CLS-531-05	250 mm	10	105.00	6903
CLS-531-06	300 mm	10	130.00	6903



Forceps

Curved Fine Points, 410 SS Grade

Cat. No.	Size	Pcs/Pack	Price / Pcs	HSN Code
CLS-532-01	100 mm	10	48.00	6903
CLS-532-02	125mm	10	72.00	6903
CLS-532-03	150 mm	10	85.00	6903
CLS-532-04	200 mm	10	95.00	6903
CLS-532-05	250 mm	10	115.00	6903
CLS-532-06	300 mm	10	140.00	6903



Forceps

Stainless Steel, Straight Blunt Points, 410 SS Grade

Cat. No.	Size	Pcs/Pack	Price / Pcs	HSN Code
CLS-533-01	100 mm	10	44.00	6903
CLS-533-02	125mm	10	60.00	6903
CLS-533-03	150 mm	10	72.00	6903
CLS-533-04	200 mm	10	98.00	6903
CLS-533-05	250 mm	10	106.00	6903
CLS-533-06	300 mm	10	130.00	6903



Forceps

Stainless Steel, Straight Blunt Points, 410 SS Grade

Cat. No.	Size	Pcs/Pack	Price / Pcs	HSN Code
CLS-534-01	100 mm	10	48.00	6903
CLS-534-02	125mm	10	65.00	6903
CLS-534-03	150 mm	10	80.00	6903
CLS-534-04	200 mm	10	90.00	6903
CLS-534-05	250 mm	10	110.00	6903
CLS-534-06	300 mm	10	130.00	6903



Spatula

Material : Stainless Steel, Grade 202

Cat. No.	Size	Type	Pcs/Pack	Price / Pcs	HSN Code
CLS-374-01	125 mm	one end spoon and one end flat	10	35.00	6903
CLS-374-02	150 mm	one end spoon and one end flat	10	45.00	6903
CLS-374-03	200 mm	one end spoon and one end flat	10	62.00	6903
CLS-374-04	250 mm	one end spoon and one end flat	10	75.00	6903
CLS-374-05	300 mm	one end spoon and one end flat	10	95.00	6903
CLS-374-06	125 mm	both end flat	10	35.00	6903
CLS-374-07	150 mm	both end flat	10	44.00	6903
CLS-374-08	200 mm	both end flat	10	62.00	6903
CLS-374-09	250 mm	both end flat	10	70.00	6903



Rubber Corks

Autoclavable with temperature range -30 to 70°C, Shore Hardness 45

Cat. No.	Type	Size (Bottom Dia x Top Dia x Height)	Pcs/Pack	Price / Pack	HSN Code
CLS-410-01		9 x 6 x 16 mm	10	28.00	6903
CLS-410-02		13 x 9 x 15.5 mm	10	30.00	6903
CLS-410-03		14 x 11 x 18.5 mm	10	36.00	6903
CLS-410-04		16.5 x 13 x 20 mm	10	42.00	6903
CLS-410-05		19 x 14 x 21 mm	10	51.00	6903
CLS-410-06		21 x 15 x 22 mm	10	56.00	6903
CLS-410-07		22.5 x 17.5 x 23 mm	10	70.00	6903
CLS-410-08		24.5 x 20 x 24 mm	10	94.00	6903
CLS-410-09		26 x 20 x 27.5 mm	10	102.00	6903
CLS-410-10		26.5 x 21 x 27.5 mm	10	125.00	6903
CLS-410-11		28 x 21.5 x 31 mm	10	155.00	6903
CLS-410-12		30 x 26 x 33 mm	10	180.00	6903
CLS-410-13		33 x 29 x 32 mm	10	210.00	6903
CLS-410-14		34.5 x 30 x 34.5 mm	10	230.00	6903
CLS-410-15		38.5 x 31 x 37 mm	10	300.00	6903
CLS-410-16		41.5 x 32 x 42.5 mm	10	340.00	6903
CLS-410-17		42 x 38 x 40.5 mm	10	438.00	6903
CLS-410-18		45 x 35 x 36.5 mm	10	440.00	6903
CLS-410-19		49.5 x 40 x 40.5 mm	10	530.00	6903
CLS-410-20		53.5 x 48 x 33.5 mm	10	590.00	6903
CLS-410-21		58 x 44 x 45 mm	10	690.00	6903
CLS-410-22		60 x 51 x 56.5 mm	10	970.00	6903
CLS-410-23	EURO DESIGN	3.5 x 6.5 x 15 mm	10	30.00	6903
CLS-410-24	EURO DESIGN	5 x 9 x 20 mm	10	30.00	6903
CLS-410-25	EURO DESIGN	8 x 12 x 20 mm	10	32.00	6903
CLS-410-26	EURO DESIGN	10.5 x 14.5 x 20 mm	10	36.00	6903
CLS-410-27	EURO DESIGN	12.5 x 16.5 x 20 mm	10	46.00	6903
CLS-410-28	EURO DESIGN	14 x 18 x 20 mm	10	66.00	6903
CLS-410-29	EURO DESIGN	17 x 22 x 25 mm	10	72.00	6903
CLS-410-30	EURO DESIGN	18 x 24 x 30 mm	10	84.00	6903
CLS-410-31	EURO DESIGN	21 x 27 x 30 mm	10	140.00	6903
CLS-410-32	EURO DESIGN	23 x 29 x 30 mm	10	150.00	6903
CLS-410-33	EURO DESIGN	26 x 32 x 30 mm	10	166.00	6903
CLS-410-34	EURO DESIGN	29 x 35 x 30 mm	10	192.00	6903
CLS-410-35	EURO DESIGN	31 x 38 x 35 mm	10	292.00	6903
CLS-410-36	EURO DESIGN	36 x 44 x 40 mm	10	390.00	6903
CLS-410-37	EURO DESIGN	41 x 49 x 40 mm	10	480.00	6903
CLS-410-38	EURO DESIGN	47 x 55 x 40 mm	10	540.00	6903
CLS-410-39	EURO DESIGN	50.5 x 59.5 x 45 mm	10	630.00	6903
CLS-410-40	EURO DESIGN	56 x 65 x 45 mm	10	1120.00	6903
CLS-410-41	EURO DESIGN	60 x 70 x 50 mm	10	1410.00	6903
CLS-410-42	EURO DESIGN	64.5 x 75.5 x 55 mm	10	1610.00	6903
CLS-410-43	EURO DESIGN	71 x 83 x 60 mm	10	1720.00	6903
CLS-410-44	EURO DESIGN	79 x 92 x 65 mm	10	1780.00	6903
CLS-410-45	EURO DESIGN	87 x 100 x 65 mm	10	2030.00	6903
CLS-410-46	EURO DESIGN	94 x 107 x 65 mm	10	2250.00	6903



Silicone Cork

Autoclavable with temperature range -50 to 250°C, Shore Hardness 45-50

Cat. No.	Type	Size (Bottom Dia x Top Dia x Height)	Pcs/Pack	Price / Pack	HSN Code
CLS-405-01	TRANSLUCENT	9 x 11.5 x 20	10	240.00	6903
CLS-405-02	TRANSLUCENT	11 x 14 x 24	10	380.00	6903
CLS-405-03	TRANSLUCENT	13 x 16 x 24	10	450.00	6903
CLS-405-04	TRANSLUCENT	15 x 18 x 24	10	550.00	6903
CLS-405-05	TRANSLUCENT	17 x 20 x 26	10	670.00	6903
CLS-405-06	TRANSLUCENT	18 x 21 x 26	10	740.00	6903
CLS-405-07	TRANSLUCENT	19 x 22.5 x 28	10	850.00	6903
CLS-405-08	TRANSLUCENT	23 x 25.5 x 28	10	1090.00	6903
CLS-405-09	TRANSLUCENT	25 x 28.5 x 28	10	1310.00	6903
CLS-405-10	TRANSLUCENT	27 x 31 x 32	10	1580.00	6903
CLS-405-11	TRANSLUCENT	29 x 33 x 32	10	2020.00	6903
CLS-405-12	TRANSLUCENT	31 x 36 x 35	10	2400.00	6903
CLS-405-13	TRANSLUCENT	33 x 38.5 x 38.5	10	3100.00	6903
CLS-405-14	EURO DESIGN	3.5 x 6.5 x 15	10	110.00	6903
CLS-405-15	EURO DESIGN	5 x 9 x 20	10	140.00	6903
CLS-405-16	EURO DESIGN	8 x 12 x 20	10	170.00	6903
CLS-405-17	EURO DESIGN	10.5 x 14.5 x 20	10	260.00	6903
CLS-405-18	EURO DESIGN	12.5 x 16.5 x 20	10	320.00	6903
CLS-405-19	EURO DESIGN	14 x 18 x 20	10	340.00	6903
CLS-405-20	EURO DESIGN	17 x 22 x 25	10	590.00	6903
CLS-405-21	EURO DESIGN	18 x 24 x 30	10	640.00	6903
CLS-405-22	EURO DESIGN	21 x 27 x 30	10	760.00	6903
CLS-405-23	EURO DESIGN	23 x 29 x 30	10	940.00	6903
CLS-405-24	EURO DESIGN	26 x 32 x 30	10	1140.00	6903
CLS-405-25	EURO DESIGN	29 x 35 x 30	10	1770.00	6903
CLS-405-26	EURO DESIGN	31 x 38 x 35	10	2130.00	6903
CLS-405-27	EURO DESIGN	36 x 44 x 40	10	2840.00	6903
CLS-405-28	EURO DESIGN	41 x 49 x 40	10	3260.00	6903
CLS-405-29	EURO DESIGN	47 x 55 x 40	10	2910.00	6903
CLS-405-30	EURO DESIGN	50.5 x 59.5 x 45	10	4290.00	6903
CLS-405-31	EURO DESIGN	56 x 65 x 45	10	4990.00	6903
CLS-405-32	EURO DESIGN	60 x 70 x 50	10	7810.00	6903
CLS-405-33	EURO DESIGN	64.5 x 75.5 x 55	10	9790.00	6903
CLS-405-34	EURO DESIGN	71 x 83 x 60	10	12510.00	6903
CLS-405-35	EURO DESIGN	79 x 92 x 65	10	16200.00	6903
CLS-405-36	EURO DESIGN	87 x 100 x 65	10	21600.00	6903
CLS-405-37	EURO DESIGN	94 x 107 x 65	10	23390.00	6903

Spatula Knife

Wooden Handle

Cat. No.	Size	Pcs/Pack	Price / Pcs	HSN Code
CLS-541-01	100 mm	6	80.00	6903
CLS-541-03	150 mm	6	90.00	6903
CLS-541-04	200 mm	6	100.00	6903
CLS-541-05	250 mm	6	140.00	6903
CLS-541-06	300 mm	6	160.00	6903

Double Spatula

Material : Stainless steel, Grade 202, one end Chattaway, one end flat

Cat. No.	Size	Pcs/Pack	Price / Pcs	HSN Code
CLS-375-01	155 mm	10	50.00	6903
CLS-375-02	210 mm	10	55.00	6903
CLS-375-03	250 mm	10	70.00	6903



Double Spatula

Material : Stainless steel, one end tapered, one end flat, flexible type, Grade 202

Cat. No.	Size	Pcs/Pack	Price / Pcs	HSN Code
CLS-376-01	155 mm	10	60.00	6903
CLS-376-02	260 mm	10	95.00	6903
CLS-376-03	305 mm	10	100.00	6903



Micro Spatula

Material : Stainless steel, one end spoon and one side spatula, Grade 202

Cat. No.	Size	Pcs/Pack	Price / Pcs	HSN Code
CLS-377-01	155 mm	10	56.00	6903



Analytical Vials and Septa Selections Guide Along with Technical Information



Capacity ml	3ml	6ml	8ml	10ml	15ml	25ml	30ml	18ml	20ml
Dimension H X D mm	41 x 11.6 mm	41 x 22 mm	61 x 16.6mm	50 x 22mm	48 X 26mm	65 X 26mm	66 X 30mm	71 x 20.6mm	86 x 22.7
Mouth Type	Crimp Neck	Crimp Neck	Screw Neck	Flip Neck	Flip Neck	Flip Neck	Flip Neck	Screw Neck	Screw Neck
Mouth Diameter mm	11 mm	20 mm	15mm	18mm	22mm	22mm	30mm	18mm	20mm
Clear	CLS-CB03C01100C000	CLS-CB06CF2000C000	CLS-CB08C01500S000	CLS-CB10C01800N000	CLS-CB15C02200N000	CLS-CB25C02200N000	CLS-CV30C130PCN000	CLS-CB16C01800S000	CLS-CB20C02000C000
Amber	CLS-CB03A011C000	CLS-CB06AF2000C000	CLS-CB08A01500S000	-	-	-	CLS-CV30A130PCN000	CLS-CB16A01800S000	CLS-CB20A02000C000
Suggested Cap	CLS-BC0000011ASC011	CLS-BC0000020ASC051	CLS-BC0000015PKS011	CLS-BC0000018PCN000	CLS-BC0000022PCN000	CLS-BC0000022PCN000	Supplied with cpas	CLS-BC0000018PKS011	CLS-BC0000020PWS011
Application	Storage	Storage	Storage	Storage/ Sampling	Storage/ Sampling	Storage/ Sampling	Process sampling (IPOA)	Storage	Storage

Vials made of Type 1st Borosilicate glass, with different volumes in clear and amber.

These are non-stock items and may require a minimum order quantity.

Please contact for pricing, closure and ordering information.

9mm Screw Vials

Product Code	Description	Price Case of 5 x 100	HSN Code
CLS-CB02C00900S000	9mm 12X32 Clear Screw Vials	10,150.00	70179090
CLS-CB02C10900S000	9mm 12X32 Clear Screw Vials with Write on Patch	12,140.00	70179090
CLS-CB02A00900S000	9mm 12X32 Amber Screw Vials	13,410.00	70179090
CLS-CB02A10900S000	9mm 12X32 Amber Screw Vials with Write on Patch	16,330.00	70179090

9 mm Screw caps with septa

Product Code	Description	Price Case of 5 x 100	HSN Code
CLS-BC000009PBS011	9mm Screw Caps with PTFE-SILICONE SEPTA	11,780.00	70179090
CLS-BC000009PBS012	9mm Screw Caps with PRE-SLIT PTFE-SILICONE SEPTA	13,280.00	70179090
CLS-BC000009PBS111	9mm Screw Caps with BONDED PTFE-SILICONE SEPTA	14,340.00	70179090
CLS-BC000009PBS112	9mm Screw Caps with BONDED PRE-SLIT PTFE-SILICONE SEPTA	15,100.00	70179090
CLS-BC000009PBS113	9mm Screw Caps with BONDED PRE-SLIT PTFE-SILICONE SEPTA	16,490.00	70179090
CLS-BC000009PBS115	9mm Screw Caps with BONDED PRE-SLIT PTFE-SILICONE SEPTA	16,490.00	70179090
CLS-BC000009PKS001	9mm Screw Closed Top Screw Caps with PTFE Lining	13,590.00	70179090

9 mm Combipack of Clear Screw Vials with matching caps

Product Code	Description	Price Case of 5 x 100	HSN Code
CLS-CV02C009PBS011	Combi pack of 9mm 12X32 Clear Screw Vials and 9mm Screw Caps with PTFE-SILICONE SEPTA	21,930.00	70179090
CLS-CV02C109PBS011	Combi pack of 9mm 12X32 Clear Screw Vials with Write on Patch and 9mm Screw Caps with PTFE-SILICONE SEPTA	23,920.00	70179090
CLS-CV02C009PBS012	Combi pack of 9mm 12X32 Clear Screw Vials and 9mm Screw Caps with PRE-SLIT PTFE-SILICONE SEPTA	23,430.00	70179090
CLS-CV02C109PBS012	Combi pack of 9mm 12X32 Clear Screw Vials with Write on Patch and 9mm Screw Caps with PRE-SLIT PTFE-SILICONE SEPTA	25,420.00	70179090
CLS-CV02C009PBS111	Combi pack of 9mm 12X32 Clear Screw Vials and 9mm Screw Caps with BONDED PTFE-SILICONE SEPTA	24,490.00	70179090
CLS-CV02C109PBS111	Combi pack of 9mm 12X32 Clear Screw Vials with Write on Patch and 9mm Screw Caps with BONDED PTFE-SILICONE SEPTA	26,480.00	70179090
CLS-CV02C009PBS112	Combi pack of 9mm 12X32 Clear Screw Vials and 9mm Screw Caps with BONDED PRE-SLIT PTFE-SILICONE SEPTA	25,250.00	70179090
CLS-CV02C109PBS112	Combi pack of 9mm 12X32 Clear Screw Vials with Write on Patch and 9mm Screw Caps with BONDED PRE-SLIT PTFE-SILICONE SEPTA	27,240.00	70179090
CLS-CV02C009PBS113	Combi pack of 9mm 12X32 Clear Screw Vials and 9mm Screw Caps with BONDED PRE-SLIT PTFE-SILICONE SEPTA	26,630.00	70179090
CLS-CV02C109PBS113	Combi pack of 9mm 12X32 Clear Screw Vials with Write on Patch and 9mm Screw Caps with BONDED PRE-SLIT PTFE-SILICONE SEPTA	28,620.00	70179090
CLS-CV02C009PBS115	Combi pack of 9mm 12X32 Clear Screw Vials and 9mm Screw Caps with BONDED PRE-SLIT PTFE-SILICONE SEPTA	28,620.00	70179090

CLS-CV02C109PBS115	Combi pack of 9mm 12X32 Clear Screw Vials with Write on Patch and 9mm Screw Caps with BONDED PRE-SLIT PTFE-SILICONE SEPTA	28,620.00	70179090
CLS-CV02C009PKS001	Combi pack of 9mm 12X32 Clear Screw Vials and 9mm Screw Closed Top Screw Caps with PTFE Lining	23,740.00	70179090
CLS-CV02C109PKS001	Combi pack of 9mm 12X32 Clear Screw Vials with Write on Patch and 9mm Screw Closed Top Screw Caps with PTFE Lining	25,730.00	70179090

Combi pack of 9 mm Amber Screw Vials with matching caps

Product Code	Description	Price Case of 5 x 100	HSN Code
CLS-CV02A009PBS011	Combi pack of 9mm 12X32 Amber Screw Vials and 9mm Screw Caps with PTFE-SILICONE SEPTA	25,190.00	70179090
CLS-CV02A109PBS011	Combi pack of 9mm 12X32 Amber Screw Vials with Write on Patch and 9mm Screw Caps with PTFE-SILICONE SEPTA	28,110.00	70179090
CLS-CV02A009PBS012	Combi pack of 9mm 12X32 Amber Screw Vials and 9mm Screw Caps with PRE-SLIT PTFE-SILICONE SEPTA	26,690.00	70179090
CLS-CV02A109PBS012	Combi pack of 9mm 12X32 Amber Screw Vials with Write on Patch and 9mm Screw Caps with PRE-SLIT PTFE-SILICONE SEPTA	29,610.00	70179090
CLS-CV02A009PBS111	Combi pack of 9mm 12X32 Amber Screw Vials and 9mm Screw Caps with BONDED PTFE-SILICONE SEPTA	27,750.00	70179090
CLS-CV02A109PBS111	Combi pack of 9mm 12X32 Amber Screw Vials with Write on Patch and 9mm Screw Caps with BONDED PTFE-SILICONE SEPTA	30,670.00	70179090
CLS-CV02A009PBS112	Combi pack of 9mm 12X32 Amber Screw Vials and 9mm Screw Caps with BONDED PRE-SLIT PTFE-SILICONE SEPTA	28,510.00	70179090
CLS-CV02A109PBS112	Combi pack of 9mm 12X32 Amber Screw Vials with Write on Patch and 9mm Screw Caps with BONDED PRE-SLIT PTFE-SILICONE SEPTA	31,430.00	70179090
CLS-CV02A009PBS113	Combi pack of 9mm 12X32 Amber Screw Vials and 9mm Screw Caps with BONDED PRE-SLIT PTFE-SILICONE SEPTA	29,890.00	70179090
CLS-CV02A109PBS113	Combi pack of 9mm 12X32 Amber Screw Vials with Write on Patch and 9mm Screw Caps with BONDED PRE-SLIT PTFE-SILICONE SEPTA	32,820.00	70179090
CLS-CV02A009PBS115	Combi pack of 9mm 12X32 Amber Screw Vials and 9mm Screw Caps with BONDED PRE-SLIT PTFE-SILICONE SEPTA	29,890.00	70179090
CLS-CV02A109PBS115	Combi pack of 9mm 12X32 Amber Screw Vials with Write on Patch and 9mm Screw Caps with BONDED PRE-SLIT PTFE-SILICONE SEPTA	32,820.00	70179090
CLS-CV02A009PKS001	Combi pack of 9mm 12X32 Amber Screw Vials and 9mm Screw Closed Top Screw Caps with PTFE Lining	27,000.00	70179090
CLS-CV02A109PKS001	Combi pack of 9mm 12X32 Amber Screw Vials and 9mm Screw Caps with BONDED PTFE Lining	29,920.00	70179090

11 mm Snap Vials

Product Code	Description	Price Case of 5 x 100	HSN Code
CLS-CB02C01100N000	11mm Clear Glass Snap Vials 12 X 32	8,040.00	70179090
CLS-CB02C11100N000	11mm Clear Glass Snap Vials 12 X 32 with Write On Patch	8,520.00	70179090
CLS-CB02A01100N000	11mm Amber Glass Snap Vials 12 X 32	10,310.00	70179090



Speak to our expert
+91-120-4968617

CLS-CB02A11100N000	11mm Amber Glass Snap Vials 12 X 32 with Write On Patch	10,560.00	70179090
--------------------	---	-----------	----------

11 mm Snap Caps with Septa

Product Code	Description	Price Case of 5 x 100	HSN Code
CLS-BC000011PCN011	11mm Snap Caps with PTFE-SILICONE SEPTA	11,930.00	70179090
CLS-BC000011PCN012	11mm Snap Caps with PRE-SLIT PTFE-SILICONE SEPTA	13,580.00	70179090

11 mm combipacks of clear snap vials with matching caps

Product Code	Description	Price Case of 5 x 100	HSN Code
CLS-CV02C011PCN011	Combi pack of 11mm Clear Glass Snap Vials 12 X 32 and 11mm Snap Caps with PTFE-SILICONE SEPTA	19,980.00	70179090
CLS-CV02C011PCN012	Combi pack of 11mm Clear Glass Snap Vials 12 X 32 and 11mm Snap Caps with PRE-SLIT PTFE-SILICONE SEPTA	21,630.00	70179090
CLS-CV02C111PCN011	Combi pack of 11mm Clear Glass Snap Vials 12 X 32 with Write On Patch and 11mm Snap Caps with PTFE-SILICONE SEPTA	20,450.00	70179090
CLS-CV02C111PCN012	Combi pack of 11mm Clear Glass Snap Vials 12 X 32 with Write On Patch and 11mm Snap Caps with PRE-SLIT PTFE-SILICONE SEPTA	22,100.00	70179090

Combi pack of 11 mm Snap Amber Vials with Matching caps

Product Code	Description	Price Case of 5 x 100	HSN Code
CLS-CV02A011PCN011	Combi pack of 11mm Amber Glass Snap Vials 12 X 32 and 11mm Snap Caps with PTFE-SILICONE SEPTA	22,250.00	70179090
CLS-CV02A011PCN012	Combi pack of 11mm Amber Glass Snap Vials 12 X 32 and 11mm Snap Caps with PRE-SLIT SILICONE SEPTA	2,390.00	70179090
CLS-CV02A111PCN011	Combi pack of 11mm Amber Glass Snap Vials 12 X 32 with Write On Patch and 11mm Snap Caps with PTFE-SILICONE SEPTA	22,490.00	70179090
CLS-CV02A111PCN012	Combi pack of 11mm Amber Glass Snap Vials 12 X 32 Caps with PRE-SLIT PTFE-SILICONE SEPTA	24,140.00	70179090

11 mm Crimp Vials

Product Code	Description	Price Case of 5 x 100	HSN Code
CLS-CB02C01100C000	11mm Clear Glass Crimp Vials 12 X 32	8,920.00	70179090
CLS-CB02C11100C000	11mm Clear Glass Crimp Vials 12 X 32 with Write On Patch	9,640.00	70179090
CLS-CB02A01100C000	11mm Amber Glass Crimp Vials 12 X 32	10,450.00	70179090
CLS-CB02A11100C000	11mm Amber Glass Crimp Vials 12 X 32 with Write On Patch	12,830.00	70179090

11 mm Crimp Caps with Septa

Product Code	Description	Price Case of 5 x 100	HSN Code
CLS-BC000011ASC011	11mm Aluminum Crimp Caps with PTFE-SILICONE SEPTA	10,870.00	70179090
CLS-BC000011ASC012	11mm Aluminum Crimp Caps with PRE-SLIT PTFE-SILICONE SEPTA	12,380.00	70179090



Speak to our expert
+91-120-4968617

CLS-BC000011ASC021	11mm Aluminum Crimp Caps with PTFE-ORANGE SILICONE SEPTA	8,450.00	70179090
CLS-BC000011ASC022	11mm Aluminum Crimp Caps with PRE-SLIT PTFE-ORANGE SILICONE SEPTA	9,960.00	70179090

11 mm Combipacks of Clear Crimp Vials with Matching Caps

Product Code	Description	Price Case of 5 x 100	HSN Code
CLS-CV02C011ASC011	Combi pack of 11mm Clear Glass Crimp Vials 12 X 32 and 11mm Aluminum Crimp Caps with PRE-SLIT PTFE-SILICONE SEPTA	19,780.00	70179090
CLS-CV02C011ASC012	Combi pack of 11mm Clear Glass Crimp Vials 12 X 32 and 11mm Aluminum Crimp Caps with PRE-SLIT PTFE-SILICONE SEPTA	21,300.00	70179090
CLS-CV02C011ASC021	Combi pack of 11mm Clear Glass Crimp Vials 12 X 32 and 11mm Aluminum Crimp Caps with PRE-SLIT PTFE-SILICONE SEPTA	17,370.00	70179090
CLS-CV02C011ASC022	Combi pack of 11mm Clear Glass Crimp Vials 12 X 32 and 11mm Aluminum Crimp Caps with PRE-SLIT PTFE-SILICONE SEPTA	18,880.00	70179090
CLS-CV02C111ASC011	Combi pack of 11mm Clear Glass Crimp Vials 12 X 32 with Write On Patch and 11mm Aluminum Crimp Caps with PTFE-SILICONE SEPTA	20,500.00	70179090
CLS-CV02C111ASC012	Combi pack of 11mm Clear Glass Crimp Vials 12 X 32 with Write On Patch and 11mm Aluminum Crimp Caps with PRE-SLIT PTFE-SILICONE SEPTA	22,020.00	70179090
CLS-CV02C111ASC021	Combi pack of 11mm Clear Glass Crimp Vials 12 X 32 with Write On Patch and 11mm Aluminum Crimp Caps with PTFE-ORANGE SILICONE SEPTA	18,090.00	70179090
CLS-CV02C111ASC022	Combi pack of 11mm Clear Glass Crimp Vials 12 X 32 with Write On Patch and 11mm Aluminum Crimp Caps with PRE-SLIT PTFE-ORANGE SILICONE SEPTA	19,600.00	70179090

Combipack of Amber Crimp Vials with Matching Caps

Product Code	Description	Price Case of 5 x 100	HSN Code
CLS-CV02A011ASC011	Combi pack of 11mm Amber Glass Crimp Vials 12 X 32 and 11mm Aluminum Crimp Caps with PTFE-SILICONE SEPTA	21,320.00	70179090
CLS-CV02A011ASC012	Combi pack of 11mm Amber Glass Crimp Vials 12 X 32 and 11mm Aluminum Crimp Caps with PRE-SLIT PTFE-SILICONE SEPTA	22,830.00	70179090
CLS-CV02A011ASC021	Combi pack of 11mm Amber Glass Crimp Vials 12 X 32 and 11mm Aluminum Crimp Caps with PTFE-ORANGE SILICONE SEPTA	18,900.00	70179090
CLS-CV02A011ASC022	Combi pack of 11mm Amber Glass Crimp Vials 12 X 32 and 11mm Aluminum Crimp Caps with PRE-SLIT PTFE-ORANGE SILICONE SEPTA	20,420.00	70179090
CLS-CV02A111ASC011	Combi pack of 11mm Amber Glass Crimp Vials 12 X 32 with Write On Patch and 11mm Aluminum Crimp Caps with PTFE-SILICONE SEPTA	23,690.00	70179090
CLS-CV02A111ASC012	Combi pack of 11mm Amber Glass Crimp Vials 12 X 32 with Write On Patch and 11mm Aluminum Crimp Caps with PRE-SLIT PTFE-SILICONE SEPTA	25,210.00	70179090
CLS-CV02A111ASC021	Combi pack of 11mm Amber Glass Crimp Vials 12 X 32 with Write On Patch and 11mm Aluminum Crimp Caps with PTFE-ORANGE SILICONE SEPTA	21,280.00	70179090



Speak to our expert
+91-120-4968617

CLS-CV02A111ASC022	Combi pack of 11mm Amber Glass Crimp Vials 12 X 32 with Write On Patch and 11mm Aluminum Crimp Caps with PRE-SLIT PTFE-ORANGE SILICONE SEPTA	22,790.00	70179090
--------------------	--	-----------	----------

13 mm Screw Vials

Product Code	Description	Price Case of 5 x 100	HSN Code
CLS-CB04C11300S000	13mm Clear Glass Screw Vials	17,730.00	70179090
CLS-CB04A11300S000	13mm Amber Glass Screw Vials	18,110.00	70179090

13 mm Screw Caps with Septa

Product Code	Description	Price Case of 5 x 100	HSN Code
CLS-BC000013PKS011	13mm Screw Caps with PTFE-SILICONE SEPTA	18,230.00	70179090

Combipacks of 13 mm Screw Vials with Matching caps

Product Code	Description	Price Case of 5 x 100	HSN Code
CLS-CV04C113PKS011	Combi pack of 13mm Clear Glass Screw Vials and 13mm Screw Caps with PTFE-SILICONE SEPTA	35,960.00	70179090

Combipacks of 13 mm Screw Amber Vials with Matching caps

Product Code	Description	Price Case of 5 x 100	HSN Code
CLS-CV04A113PKS011	Combi pack of 13mm Amber Glass Screw Vials and 13mm Screw Caps with PTFE-SILICONE SEPTA	36,340.00	70179090

EPA Pre-Assembled Vials

Product Code	Description	Price / 72 Pcs	HSN Code
CLS-CV20C124PWS111	20ml Clear Glass EPA Vial with PTFE SILICONE SEPTA Bonded to a 24mm White Screw Cap, 72/pack	8,277.00	70179090
CLS-CV30C124PWS111	30ml Clear Glass EPA Vial with PTFE SILICONE SEPTA Bonded to a 24mm White Screw Cap, 72/pack	9,167.00	70179090
CLS-CV40C124PWS111	40ml Clear Glass EPA Vial with PTFE SILICONE SEPTA Bonded to a 24mm White Screw Cap, 72/pack	11,045.00	70179090
CLS-CV60C124PWS111	60ml Clear Glass EPA Vial with PTFE SILICONE SEPTA Bonded to a 24mm White Screw Cap, 72/pack	15,087.00	70179090
CLS-CV20A124PWS111	20ml Amber Glass EPA Vial with PTFE SILICONE SEPTA Bonded to a 24mm White Screw Cap, 72/pack	9,192.00	70179090
CLS-CV30A124PWS111	30ml Amber Glass EPA Vial with PTFE SILICONE SEPTA Bonded to a 24mm White Screw Cap, 72/pack	10,278.00	70179090
CLS-CV40A124PWS111	40ml Amber Glass EPA Vial with PTFE SILICONE SEPTA Bonded to a 24mm White Screw Cap, 72/pack	12,570.00	70179090
CLS-CV60A124PWS111	60ml Amber Glass EPA Vial with PTFE SILICONE SEPTA Bonded to a 24mm White Screw Cap, 72/pack	17,502.00	70179090



Speak to our expert
+91-120-4968617

20 ml Head Space GC Vials

Product Code	Description	Price / Case lot of 2 x 100 Pcs	HSN Code
CLS-CB20F12000C000	20ml Clear Glass Flat Bottom Headspace Crimp Vial	13,760.00	70179090
CLS-CB20R12000C000	20ml Clear Glass Round Bottom Headspace Crimp Vial	13,760.00	70179090
CLS-CB20F12000S000	20ml Clear Glass Flat Bottom Headspace Screw Vial	18,610.00	70179090
CLS-CB20R12000S000	20ml Clear Glass Round Bottom Headspace Screw Vial	20,535.00	70179090

20 mm GC caps with septa

Product Code	Description	Price / Case lot of 2 x 100 Pcs	HSN Code
CLS-BC000020ASC051	Headspace Aluminum Crimp Caps with PTFE-SILICONE SEPTA	14,370.00	70179090
CLS-BC000020ASC041	Headspace Aluminum Crimp Caps with Ultra Low Bleed PTFE-SILICONE SEPTA	16,120.00	70179090
CLS-BC000020MSC041	Headspace Magnetic Crimp Caps with Ultra Low Bleed PTFE-SILICONE SEPTA	17,880.00	70179090

Headspace Magnetic Screw Cap Closure

Product Code	Description	Price / Case lot of 2 x 100 Pcs	HSN Code
CLS-BC000020MSS061	Headspace Magnetic Screw Caps with PTFE-SILICONE SEPTA	34,785.00	70179090

Combi packs of 20 mm GC Flat Bottom Vials with Matching Caps

Product Code	Description	Price / Case lot of 2 x 100 Pcs	HSN Code
CLS-CV20F120ASC051	Combi pack of 20ml Clear Glass Flat Bottom Headspace Crimp Vial and Headspace Aluminum Crimp Caps with PTFE-SILICONE SEPTA	28,130.00	70179090
CLS-CV20F120ASC041	Combi pack of 20ml Clear Glass Flat Bottom Headspace Crimp Vial and Headspace Aluminum Crimp Caps with Ultra Low Bleed PTFE-SILICONE SEPTA	29,880.00	70179090
CLS-CV20F120MSC041	Combi pack of 20ml Clear Glass Flat Bottom Headspace Crimp Vial and Headspace Magnetic Crimp Caps with Ultra Low Bleed PTFE-SILICONE SEPTA	31,635.00	70179090

Combi packs of 20 mm GC Round Bottom Vials with Matching Caps

Product Code	Description	Price / Case lot of 2 x 100 Pcs	HSN Code
CLS-CV20R120ASC051	Combi pack of 20ml Clear Glass Round Bottom Headspace Crimp Vial and Headspace Aluminum Crimp Caps with PTFE-SILICONE SEPTA	28,130.00	70179090
CLS-CV20R120ASC041	Combi pack of 20ml Clear Glass Round Bottom Headspace Crimp Vial and Headspace Aluminum Crimp Caps with Ultra Low Bleed PTFE-SILICONE SEPTA	29,880.00	70179090
CLS-CV20R120MSC041	Combi pack of 20ml Clear Glass Round Bottom Headspace Crimp Vial and Headspace Magnetic Crimp Caps with Ultra Low Bleed PTFE-SILICONE SEPTA	31,635.00	70179090



Speak to our expert
+91-120-4968617

Combipacks of 20 mm GC Flat Bottom Vials with Matching Caps

Product Code	Description	Price / Case lot of 2 x 100 Pcs	HSN Code
CLS-CV20F120MSS061	Combi pack of 20ml Clear Glass Flat Bottom Headspace Screw Vial and Headspace Magnetic Screw Caps with PTFE-SILICONE SEPTA	50,155.00	70179090

Combipacks of 20 ml Round bottom screw Vials with Matching Caps

Product Code	Description	Price / Case lot of 2 x 100 Pcs	HSN Code
CLS-CV20R120MSS061	Combi pack of 20ml Clear Glass Round Bottom Headspace Screw Vial and Headspace Magnetic Screw Caps with PTFE-SILICONE SEPTA	55,320.00	70179090

10 ml Headspace Vials

Product Code	Description	Price / Case lot of 2 x 100 Pcs	HSN Code
CLS-CB10F12000C000	10ml Clear Glass Flat Bottom Headspace Crimp Vial	7,005.00	70179090
CLS-CB10R12000C000	10ml Clear Glass Round Bottom Headspace Crimp Vial	1,669.00	70179090
CLS-CB10F12000S000	10ml Clear Glass Flat Bottom Headspace Screw Vial	2,330.00	70179090
CLS-CB10R12000S000	10ml Clear Glass Round Bottom Headspace Screw Vial	2,506.00	70179090

10 ml Flat Bottom Crimp Vials with closure

Product Code	Description	Price / Case lot of 2 x 100 Pcs	HSN Code
CLS-CV10F120ASC051	Combi pack of 10ml Clear Glass Flat Bottom Headspace Crimp Vial and Headspace Aluminum Crimp Caps with PTFE-SILICONE SEPTA	21,375.00	70179090
CLS-CV10F120ASC041	Combi pack of 10ml Clear Glass Flat Bottom Headspace Crimp Vial and Headspace Aluminum Crimp Caps with Ultra Low Bleed PTFE-SILICONE SEPTA	23,125.00	70179090
CLS-CV10F120MSC041	Combi pack of 10ml Clear Glass Flat Bottom Headspace Crimp Vial and Headspace Magnetic Crimp Caps with Ultra Low Bleed PTFE-SILICONE SEPTA	26,715.00	70179090

10 ml Round Bottom Crimp Vials with closure

Product Code	Description	Price / Case lot of 2 x 100 Pcs	HSN Code
CLS-CV10R120ASC051	Combi pack of 10ml Clear Glass Round Bottom Headspace Crimp Vial and Headspace Aluminum Crimp Caps with PTFE-SILICONE SEPTA	24,190.00	70179090
CLS-CV10R120ASC041	Combi pack of 10ml Clear Glass Round Bottom Headspace Crimp Vial and Headspace Aluminum Crimp Caps with Ultra Low Bleed PTFE-SILICONE SEPTA	24,465.00	70179090
CLS-CV10R120MSC041	Combi pack of 10ml Clear Glass Round Bottom Headspace Crimp Vial and Headspace Magnetic Crimp Caps with Ultra Low Bleed PTFE-SILICONE SEPTA	28,055.00	70179090

10 ml HS screw Vials with closure

Product Code	Description	Price / Case lot of 2 x 100 Pcs	HSN Code
CLS-CV10F120MSS061	Combi pack of 10ml Clear Glass Flat Bottom Headspace Screw Vial and Headspace Magnetic Screw Caps with PTFE-SILICONE SEPTA	43,195.00	70179090

CLS-CV10R120MSS061	Combi pack of 10ml Clear Glass Round Bottom Headspace Screw Vial and Headspace Magnetic Screw Caps with PTFE-SILICONE SEPTA	47,315.00	70179090
--------------------	---	-----------	----------

Technical Information on Closures for Special purpose/ Storage vials

Product Code	Description	Pack Size	Compatible with
BC000015PKS011	15mm Closed top Screw Cap with PTFE-SILICONE septa 100/pk	100/pk X 5	CB08C01500S000
			CB08A01500S000
BC000018PCN000	18mm Clear Flip Top Cap 1000/pk	1000/pk x 5	CB10C01800N000
BC000022PCN000	22mm Clear Flip Top Cap 1000/pk	1000/pk x 5	CB15C02200N000
			CB25C02200N000
BC000018PKS011	18mm Black Closed top Screw Cap with PTFE-SILICONE Septa 100/pk	100/pk X 5	CB16C01800S000
			CB16A01800S000
BC000020PWS011	20mm White Closed Top Screw Cap with PTFE - SILICONE Septa 100/pk	100/pk x 5	CB20C02000C000
			CB20A02000C000

CLS Molecular biology Product's



For more information



+91-120-4968617

For more information



www.compositelabline.com

Molecular biology

Cat#	Product Name	Size	Unit Rate	HSN
A. RNA Isolation				
CLS0102	Trizol Reagent	100ml	14170.00	38220090
CLS0202	Trizol LS Reagent	100ml	15470.00	38220090
CLS0302	RNApure Total RNA Mini Kit	50 applications	16770.00	38220090
CLS4901	PAX Blood RNA Kit (For PAXgene Blood RNA Tube)	50 applications	39000.00	38220090
CLS2302	RNAliquid RNA Blood/Serum/Plasma Kit	50 applications	16770.00	38220090
CLS3401	DNase Digestion Kit (On Spin Columns)	50 applications	7670.00	38220090
CLS0902	CLS RNA Plant Mini Kit	50 applications	24570.00	38220090
CLS0702	CLS RNA Mini Kit (for tissues and cells RNA)	50 applications	19370.00	38220090
CLS2802	CLS Plus RNA Mini Kit (for tissues and cells RNA)	50 applications	27170.00	38220090
CLS5401	CLS Plus Bone Tissue RNA Kit	50 applications	34970.00	38220090
CLS2902	EASYall RNA/DNA Mini Kit (purify genomic DNA and total RNAsimultaneously from a single biological sample)	50 applications	29770.00	38220090
CLS3602	EASYall RNA/DNA/Protein Mini Kit (purify genomic DNA, total RNA, and total protein simultaneously from a single biological sample)	50 applications	33670.00	38220090
CLS0501	miEASY microRNA Mini Kit (for tissues and cells miRNA and other microRNA)	50 applications	41470.00	38220090
CLS4601	miEASY microRNA Serum/Plasma Kit (for Serum/Plasma miRNA and other microRNA)	50 applications	41470.00	38220090
CLS2401	miEASY microRNA Blood/Serum/Plasma Kit (for Blood/Serum/Plasma miRNA and other microRNA)	50 applications	42770.00	38220090
CLS5101	PAX Blood miRNA Kit (For PAXgene Blood RNA Tube) (for total RNA >18 nucleotides (including miRNA) from blood samples stored in preservation reagents and Blood RNA Tubes)	50 applications	60970.00	38220090
CLS1402	RNAclean RNA Purification Kit	50 applications	12870.00	38220090
CLS1502	RNAfixer Stabilization Solution	100 ml	9315.00	38220090
B. Genomic DNA Isolation				
CLS0701	CLS Plus DNA Mini Kit (Blood or Tissue)	50 applications	10270.00	38220090
CLS0702	CLS Plus DNA Mini Kit (Blood or Tissue)	100 applications	16770.00	38220090
CLS0201	Small Amount Blood DNA Mini kit (30 ml)	100 applications*0.3ml	6500.00	38220090
CLS0401	Greatl Amount Blood DNA kit (1000 ml)	96 applications*10ml	97370.00	38220090
CLS1501	Plant DNA Mini Kit	50 applications	10270.00	38220090
CLS1502	Plant DNA Mini Kit	100 applications	16770.00	38220090
CLS2301	Stool DNA Mini Kit (with proteinase K)	50 applications	21970.00	38220090
C. Plasmid Preparations				
CLS0301	High Pure Plasmid Mini Kit	50 applications	5070.00	38220090
CLS0302	High Pure Plasmid Mini Kit	100 applications	7670.00	38220090
CLS0601	Yeast Plasmid Mini Kit (with Lytic Enzyme)	50 applications	8970.00	38220090
CLS0402	EndoFree Plasmid Mini Kit (spin column)	50 applications	7670.00	38220090
CLS1201	High Pure Plasmid Maxi Kit (spin column)	10 applications	12870.00	38220090
CLS1301	EndoFree Plasmid Maxi Kit (spin column)	10 applications	18070.00	38220090
D. DNA Recovery and Concentrate				
CLS0101	CLS Gel Extraction Kit	50 applications	5070.00	38220090
CLS0102	CLS Gel Extraction Kit	100 applications	8970.00	38220090
CLS0201	CLS PCR Purification Kit	50 applications	5070.00	38220090
CLS0202	CLS PCR Purification Kit	100 applications	8970.00	38220090
CLS0401	CLS Oligo Purification Kit	50 applications	7670.00	38220090
CLS0501	PAGE Extraction Kit	50 applications	5980.00	38220090
E. Nucleic Acid Gel Stain				
CLS1001	AidGreen (Similar as GelGreen)	0.5 ml	11570.00	38220090
CLS1101	AidRed (Similar as GelRed)	0.5 ml	11570.00	38220090



Speak to our expert
+91-120-4968617

Molecular biology

Cat#	Product Name	Size	Unit Rate	HSN
F. PCR & RT-PCR				
CLS2302	dNTP Mixture 2.5mM each solution	1ml	1287.00	38220090
CLS2303	dNTP Mixture 2.5mM each solution	5ml	5070.00	38220090
CLS2402	dNTP Mixture 10mM each solution	1ml	3237.00	38220090
CLS2403	dNTP Mixture 10mM each solution	5ml	15470.00	38220090
CLS5101	High Pure dNTP Mixture 2.5mM each solution	1ml	1547.00	38220090
CLS5102	High Pure dNTP Mixture 2.5mM each solution	5ml	6877.00	38220090
CLS5201	High Pure dNTP Mixture 10mM each solution	1ml	4147.00	38220090
CLS5202	High Pure dNTP Mixture 10mM each solution	5ml	19370.00	38220090
CLS0102	Taq DNA Polymerase (Buffer with Mg2+ Added)	500U	3237.00	38220090
CLS0103	Taq DNA Polymerase (Buffer with Mg2+ Added)	1, 000U	6370.00	38220090
CLS0104	Taq DNA Polymerase (Buffer with Mg2+ Added)	3, 000U	12870.00	38220090
CLS0112	Taq DNA Polymerase (Buffer without Mg2+)	500U	3237.00	38220090
CLS0113	Taq DNA Polymerase (Buffer without Mg2+)	1, 000U	6370.00	38220090
CLS0114	Taq DNA Polymerase (Buffer without Mg2+)	3, 000U	12870.00	38220090
CLS0912	2×Taq PCR MasterMix (Without Dye)	1ml	2470.00	38220090
CLS0913	2×Taq PCR MasterMix (Without Dye)	5ml	11570.00	38220090
CLS0903	2×Taq PCR MasterMix (With Dye)	5ml	11570.00	38220090
CLS5801	TRUEScript RT MasterMix (for real time PCR)	20µl system x 50 reactions	19370.00	38220090
CLS5802	TRUEScript RT MasterMix (for real time PCR)	20µl system x 100 reactions	32370.00	38220090
CLS0502	Hot Master Taq DNA Polymerase	500U	7670.00	38220090
CLS0503	Hot Master Taq DNA Polymerase	2,500U	32370.00	38220090
CLS1302	2×Hotstart PCR MasterMix (With Dye)	5ml	20670.00	38220090
CLS8201	FastHiFi PCR Master Mix	1ml	2067.00	38220090
CLS8202	FastHiFi PCR Master Mix	5ml	11570.00	38220090
CLS8001	FastLong PCR MasterMix	1ml	1677.00	38220090
CLS8002	FastLong PCR MasterMix	5ml	8970.00	38220090
CLS8401	CYA9 LongHiFi PCR MasterMix	1ml	4277.00	38220090
CLS8402	CYA9 LongHiFi PCR MasterMix	5ml	21970.00	38220090
CLS1312	2×Hotstart PCR MasterMix (Without Dye)	5ml	20670.00	38220090
CLS0302	Pfu DNA Polymerase (with HighPure dNTP mix)	500U	5070.00	38220090
CLS0303	Pfu DNA Polymerase (with HighPure dNTP mix)	3,000U	25870.00	38220090
CLS1101	2×PFU PCR MasterMix (With Dye)	1ml	3770.00	38220090
CLS1102	2×PFU PCR MasterMix (With Dye)	5ml	15470.00	38220090
CLS1111	2×PFU PCR MasterMix (Without Dye)	1ml	3770.00	38220090
CLS1112	2×PFU PCR MasterMix (Without Dye)	5ml	15470.00	38220090
CLS3301	2× SYBR Green qPCR Mix	1.25ml (50ul reaction system ×50 reactions)	8970.00	38220090
CLS3302	2× SYBR Green qPCR Mix	5ml (50ul reaction system ×200 reactions)	27170.00	38220090
CLS4001	20 × SYBR Green I (For Real Time PCR)	20ul reaction system ×100 reactions	1170.00	38220090
CLS1702	TRUEScript H Minus M-MuLV Reverse Transcriptase	10, 000U	6370.00	38220090
CLS1703	TRUEScript H Minus M-MuLV Reverse Transcriptase	50, 000U	29770.00	38220090
CLS1802	TRUEScript 1st Strand cDNA Synthesis Kit	20ul reaction system ×50 reactions	19370.00	38220090
CLS4301	Sure script H Minus M-MuLV Reverse Transcriptase	5, 000U	14170.00	38220090
CLS4302	Sure script H Minus M-MuLV Reverse Transcriptase	10, 000U	25870.00	38220090
CLS4401	Sure script 1st Strand cDNA Synthesis Kit	20ul reaction system ×25 reactions	19370.00	38220090
CLS4402	Sure script 1st Strand cDNA Synthesis Kit	20ul reaction system ×50 reactions	32370.00	38220090

Molecular biology

Cat#	Product Name	Size	Unit Rate	HSN
CLS3401	TRUEscript One Step RT-PCR Kit	20ul reaction system ×125 reactions	19370.00	38220090
CLS3402	TRUEscript One Step RT-PCR Kit	20ul reaction system ×250 reactions	37570.00	38220090
CLS3601	TRUEscript SYBR Green qRT-PCR Kit	50ul reaction system ×25 reactions	14170.00	38220090
CLS3602	TRUEscript SYBR Green qRT-PCR Kit	50ul reaction system ×50 reactions	24570.00	38220090
G. Cloning Vector				
CLS1401	CLS pTOPO-TA Cloning Kit	20 applications *10ul reaction system	11570.00	38220090
CLS1402	CLS pTOPO-TA Cloning Kit	80 applications *10ul reaction system	40170.00	38220090
CLS1501	CLS pTOPO-TA Simple Cloning Kit	20 applications *10ul reaction system	11570.00	38220090
CLS1502	CLS pTOPO-TA Simple Cloning Kit	80 applications *10ul reaction system	40170.00	38220090
CLS1601	CLS pTOPO-Blunt Cloning Kit	20 applications *10ul reaction system	11570.00	38220090
CLS1602	CLS pTOPO-Blunt Cloning Kit	80 applications *10ul reaction system	40170.00	38220090
CLS01701	CLS pTOPO-Blunt Simple Cloning Kit	20 applications *10ul reaction system	11570.00	38220090
CLS01702	CLS pTOPO-Blunt Simple Cloning Kit	80 applications *10ul reaction system	40170.00	38220090
CLS01201	Seamless Assembly and Cloning kit	10 applications	14170.00	38220090

Pan-Tag Antibody

Cat#	Product description	Reactivity	Application	Unit Price (50µl)	Unit Price (100µl)	HSN
CLS1189	α-skeletal Muscle Actin mAb	H,R,M	WB IP IHC	18000.00	32000.00	38220090
CLS1211	α-skeletal Muscle Actin pAb	H,R,M	WB IHC	18000.00	32000.00	38220090
CLS1340	α-Smooth Muscle Actin Mouse mAb	H,R,M	WB IHC	18000.00	32000.00	38220090
CLS1341	α-Smooth Muscle Actin Mouse mAb	H,R,M	WB IHC	18000.00	32000.00	38220090
CLS1210	α-Smooth Muscle Actin pAb	H,R,M	WB IHC	18000.00	32000.00	38220090
CLS1036	α-tubulin Rabbit pAb	H,M,R	WB IHC	18000.00	32000.00	38220090
CLS1494	α-tubulin (Acetyl Lys40) mAb	H,M,R	WB IHC	18000.00	32000.00	38220090
CLS1560	α-tubulin (Acetyl Lys40) mAb	H,M,R	WB IHC	18000.00	32000.00	38220090
CLS1052	α-tubulin mAb Hot	H,M,R	WB IP IF	18000.00	32000.00	38220090
CLS1143	α-tubulin mAb	Zebrafish	WB	18000.00	32000.00	38220090
CLS1036	α-tubulin pAb Hot	H,R,M	WB IHC	18000.00	32000.00	38220090
CLS1029	β-actin Mouse mAb Hot	H,R,M...	WB IHC IF	18000.00	32000.00	38220090
CLS1056	β-actin Mouse mAb-HRP	H,R,M...	WB	26100.00	44800.00	38220090
CLS1049	β-actin Mouse mAb	H,R,M...	WB IHC IF	18000.00	32000.00	38220090
CLS1166	β-actin Mouse mAb	H,R,M...	WB IHC IF	18000.00	32000.00	38220090
CLS1033	β-actin Rabbit pAb Hot	H,M,R...	WB IHC IF	18000.00	32000.00	38220090
CLS1226	β-Tubulin Rabbit pAb	H,R,M	WB IHC	18000.00	32000.00	38220090
CLS1031	β-Tubulin Mouse mAb Hot	H,R,M...	WB IHC IF	18000.00	32000.00	38220090
CLS1326	β-Tubulin Mouse mAb-HRP	H,R,M...	WB IHC	26100.00	44800.00	38220090
CLS1167	β-Tubulin Mouse mAb	H,R,M...	WB IHC IP	18000.00	32000.00	38220090
CLS1163	β-Tubulin Mouse mAb (M7)	H,R,M	WB IF	18000.00	32000.00	38220090
CLS1142	β-Tubulin Mouse mAb	Zebrafish	WB IHC IF	18000.00	32000.00	38220090
CLS1054	β I tubulin Mouse mAb	H,R,M	WB	18000.00	32000.00	38220090
CLS1191	β II Tubulin Mouse mAb	R,M,(H)	WB IP	18000.00	32000.00	38220090
CLS1225	β II Tubulin Mouse mAb	H,R,M	WB	18000.00	32000.00	38220090
CLS1606	γ Tubulin Mouse mAb	H	IHC	18000.00	32000.00	38220090
CLS1621	γ Tubulin Mouse mAb	H,R,M	WB IHC	18000.00	32000.00	38220090
CLS1620	γ Tubulin Mouse mAb	H,R,M	WB IHC	18000.00	32000.00	38220090
CLS1607	γ Tubulin Mouse mAb	H	IHC	18000.00	32000.00	38220090
CLS1622	ε Tubulin Mouse mAb	H,R,M	WB	18000.00	32000.00	38220090
CLS1630	ε Tubulin Mouse mAb	H,R,M	IHC	18000.00	32000.00	38220090
CLS1613	ε Tubulin Mouse mAb	H,R,M	IHC	18000.00	32000.00	38220090
CLS1324	AmCyan Mouse mAb	N/A	WB IHC IP	18000.00	32000.00	38220090
CLS1178	AmCyan Mouse pAb	H,R,M,Mk...	WB IHC IF IP	18000.00	32000.00	38220090
CLS1184	AmCyan pAb	N/A	WB IHC IF IP	18000.00	32000.00	38220090
CLS1193	Avi-Tag mAb	N/A	WB	18000.00	32000.00	38220090
CLS1179	BFP Mouse pAb	N/A	WB IHC IF IP	18000.00	32000.00	38220090
CLS1185	BFP pAb	N/A	WB IHC IF IP	18000.00	32000.00	38220090

Pan-Tag Antibody

Cat#	Product description	Reactivity	Application	Unit Price (50µl)	Unit Price (100µl)	HSN
CLS1420	BSA Mouse mAb	Cow	WB ELISA	18000.00	32000.00	38220090
CLS1154	CBP-Tag Mouse mAb	N/A	WB IP	18000.00	32000.00	38220090
CLS1002	c-Myc-Tag Mouse mAb Hot	N/A	WB IP IF	18000.00	32000.00	38220090
CLS1041	c-Myc-Tag Mouse mAb	N/A	WB IP IF	18000.00	32000.00	38220090
CLS1170	c-Myc-Tag Mouse mAb	N/A	WB IP IF	18000.00	32000.00	38220090
CLS1022	c-Myc-Tag Rabbit pAb Hot	N/A	WB	18000.00	32000.00	38220090
CLS1050	COX IV Mouse mAb	H,R,M	WB IF	18000.00	32000.00	38220090
CLS1013	E2-Tag Mouse mAb	N/A	WB	18000.00	32000.00	38220090
CLS1325	EBFP Mouse mAb	N/A	WB IHC IP	18000.00	32000.00	38220090
CLS1352	ECFP mAb	H,R,M	WB	18000.00	32000.00	38220090
CLS1174	ECFP pAb	N/A	WB IP	18000.00	32000.00	38220090
CLS1058	ECFP-Tag Mouse pAb	N/A	WB IHC IF	18000.00	32000.00	38220090
CLS1223	eNOS Mouse mAb (Mix)	H,R,M	WB	18000.00	32000.00	38220090
CLS1048	EYFP-Tag Mouse pAb	N/A	WB IP IF	18000.00	32000.00	38220090
CLS1175	EYFP pAb	N/A	WB IHC IF IP	18000.00	32000.00	38220090
CLS1322	EYFP Mouse pAb	N/A	WB IHC IP	18000.00	32000.00	38220090
CLS1001	Flag-Tag Mouse mAb	N/A	WB IP IF	18000.00	32000.00	38220090
CLS1020	Flag-Tag Rabbit pAb Hot	N/A	WB	18000.00	32000.00	38220090
CLS1421	GAPDH pAb	H,R,Bac...	WB IHC	18000.00	32000.00	38220090
CLS1030	GAPDH Mouse mAb Hot	H,R,M...	WB IHC IF	18000.00	32000.00	38220090
CLS1057	GAPDH Mouse mAb-HRP	H,R,M...	WB	26100.00	44800.00	38220090
CLS1034	GAPDH Rabbit pAb Hot	H,M,R...	WB IHC IF	18000.00	32000.00	38220090
CLS1141	GAPDH pAb	Zabrafish	WB IHC IF	18000.00	32000.00	38220090
CLS1009	GFP-Tag Mouse mAb	N/A	WB	18000.00	32000.00	38220090
CLS1019	GFP-Tag Mouse mAb	N/A	WB	18000.00	32000.00	38220090
CLS1152	GFP Mouse mAb	N/A	WB IHC IF IP	18000.00	32000.00	38220090
CLS1046	GFP-Tag Mouse pAb	N/A	WB IHC IF IP	18000.00	32000.00	38220090
CLS1152	GFP Mouse mAb Hot	N/A	WB IP	18000.00	32000.00	38220090
CLS1025	GFP-Tag Rabbit pAb	N/A	WB	18000.00	32000.00	38220090
CLS1760	Glu-Glu-Tag Mouse mAb	N/A	WB	18000.00	32000.00	38220090
CLS1038	GST Mouse mAb	N/A	WB	18000.00	32000.00	38220090
CLS1037	GST Mouse mAb	N/A	WB	18000.00	32000.00	38220090
CLS1007	GST-Tag Mouse mAb Hot	N/A	WB	18000.00	32000.00	38220090
CLS1172	GST-Tag Mouse mAb	N/A	WB IP	18000.00	32000.00	38220090
CLS1024	GST-Tag Rabbit pAb Hot	N/A	WB	18000.00	32000.00	38220090
CLS1186	HA-Tag Mouse mAb	N/A	WB IP	18000.00	32000.00	38220090
CLS1003	HA-Tag Mouse mAb	N/A	WB IP IF	18000.00	32000.00	38220090
CLS1168	HA-Tag Mouse mAb (Mix) Hot	N/A	WB IP IF	18000.00	32000.00	38220090
CLS1021	HA-Tag Rabbit pAb Hot	N/A	WB	18000.00	32000.00	38220090
CLS1004	His-Tag Mouse mAb Hot	N/A	WB IP IF	18000.00	32000.00	38220090
CLS1169	His-Tag Mouse mAb	N/A	WB IP IF	18000.00	32000.00	38220090
CLS1157	His-Tag Mouse mAb	N/A	WB IP	18000.00	32000.00	38220090
CLS1023	His-Tag Rabbit pAb Hot	N/A	WB	18000.00	32000.00	38220090
CLS1190	Histone H3 Mouse mAb	H,M,R	WB	18000.00	32000.00	38220090
CLS1055	Histone H3 Mouse mAb Hot	H,M,R,Yeast	WB IHC IF IP	18000.00	32000.00	38220090
CLS1188	Histone H3 Mouse mAb	H,M,R	WB IHC IF IP	18000.00	32000.00	38220090
CLS1148	Histone H3 Mouse mAb	Zabrafish	WB	18000.00	32000.00	38220090
CLS1236	Histone H3 pAb	H	WB IHC	18000.00	32000.00	38220090
CLS1014	HSV-Tag Mouse mAb	N/A	WB	18000.00	32000.00	38220090
CLS1140	HSV-Tag Mouse mAb	N/A	WB	18000.00	32000.00	38220090
CLS1015	KT3-Tag Mouse mAb	N/A	WB	18000.00	32000.00	38220090
CLS1053	Lamin B1 Mouse mAb	H,R,M	WB IP	18000.00	32000.00	38220090
CLS1205	Lamin B1 pAb	H,R,M	WB IHC	18000.00	32000.00	38220090
CLS1008	MBP-Tag Mouse mAb	N/A	WB	18000.00	32000.00	38220090
CLS1028	MBP-Tag Rabbit pAb	N/A	WB IP	18000.00	32000.00	38220090
CLS1010	mCherry-Tag Mouse mAb	N/A	WB	18000.00	32000.00	38220090
CLS1153	mCherry-Tag Mouse mAb	N/A	WB IP	18000.00	32000.00	38220090
CLS1047	mCherry-Tag Mouse pAb	N/A	WB IP IF	18000.00	32000.00	38220090
CLS1026	mCherry-Tag Rabbit pAb	N/A	WB IP	18000.00	32000.00	38220090
CLS1323	mOrange Mouse mAb	N/A	WB IHC IP	18000.00	32000.00	38220090
CLS1183	mOrange Mouse pAb	N/A	WB IHC IF IP	18000.00	32000.00	38220090
CLS1176	mOrange pAb	N/A	WB IHC IF IP	18000.00	32000.00	38220090
CLS1222	mStrawberry Mouse mAb	N/A	WB	18000.00	32000.00	38220090
CLS1180	mStrawberry Mouse pAb	N/A	WB IHC IF IP	18000.00	32000.00	38220090
CLS1181	mStrawberry pAb	N/A	WB IHC IF IP	18000.00	32000.00	38220090
CLS1605	Muscle actin mAb	H,R,M	IHC	18000.00	32000.00	38220090

Pan-Tag Antibody

Cat#	Product description	Reactivity	Application	Unit Price (50µl)	Unit Price (100µl)	HSN
CLS1616	Muscle actin mAb	H,R,M	WB IHC	18000.00	32000.00	38220090
CLS1612	Muscle actin mAb	H,R,M	IHC	18000.00	32000.00	38220090
CLS1473	Nano-Tag9 mAb	All	WB	18000.00	32000.00	38220090
CLS1474	Nano-Tag9 mAb	All	WB	18000.00	32000.00	38220090
CLS1032	PCNA Mouse mAb	H,R,M	WB IHC IF	18000.00	32000.00	38220090
CLS1150	Plant Actin Mouse mAb	Plants	WB	18000.00	32000.00	38220090
CLS1051	Plant Actin Mouse mAb Hot	Plants	WB	18000.00	32000.00	38220090
CLS1187	Plant Actin Mouse mAb (Mix)	Plants	WB IHC	18000.00	32000.00	38220090
CLS1035	Plant Actin Rabbit pAb Hot	Plants	WB	18000.00	32000.00	38220090
CLS1060	Plant GST Rabbit pAb	Nicotiana	WB	18000.00	32000.00	38220090
CLS1302	Rabbit IgG (G+H) Mouse mAb	Rabbit	WB IHC	18000.00	32000.00	38220090
CLS1011	RFP-Tag Mouse mAb	N/A	WB	18000.00	32000.00	38220090
CLS1045	RFP-Tag Mouse pAb	N/A	WB IHC IP	18000.00	32000.00	38220090
CLS1321	RFP-Tag Mouse pAb (Mix)	N/A	WB IHC IP	18000.00	32000.00	38220090
CLS1027	RFP-Tag Rabbit pAb	N/A	WB	18000.00	32000.00	38220090
CLS1182	Rubisco Mouse pAb	Plants	WB	18000.00	32000.00	38220090
CLS1484	Rubisco (Large Chain) mAb	Plants	WB	18000.00	32000.00	38220090
CLS1485	Rubisco (Large Chain) mAb	H,R,M	WB IHC	18000.00	32000.00	38220090
CLS1449	S1-Tag Mouse mAb	All	WB	18000.00	32000.00	38220090
CLS1194	SRT-Tag Mouse mAb	N/A	WB	18000.00	32000.00	38220090
CLS1017	S-Tag Mouse mAb	N/A	WB	18000.00	32000.00	38220090
CLS1016	Strep-Tag Mouse mAb	N/A	WB	18000.00	32000.00	38220090
CLS1195	Strep Tag II Mouse mAb (Mix)	N/A	WB	18000.00	32000.00	38220090
CLS1012	T7-Tag Mouse mAb	N/A	WB	18000.00	32000.00	38220090
CLS1155	TAP-Tag Mouse mAb	N/A	WB IP	18000.00	32000.00	38220090
CLS1018	Trx-Tag Mouse mAb	N/A	WB	18000.00	32000.00	38220090
CLS1005	V5-Tag Mouse mAb Hot	N/A	WB IP IF	18000.00	32000.00	38220090
CLS1039	V5-Tag Mouse mAb	N/A	WB	18000.00	32000.00	38220090
CLS1171	V5-Tag Mouse mAb (Mix)	N/A	WB IP IF	18000.00	32000.00	38220090
CLS1006	VSV-G-Tag Mouse mAb	N/A	WB	18000.00	32000.00	38220090

Reach us out

Telephone

E-mail

Website

Antibodies
HSN : 38220090

Cat#	Product Description	MW	Reactivity	Application	Pack Size	Unit Price
CLSAF0004	Phospho-VEGFR2(Tyr1214) Antibody	152kDa	Human, Mouse, Rat	WB IHC	200ug	59670
CLSAF0016	Phospho-Akt(Ser473) Antibody	60kDa	Human, Mouse, Rat	WB IHC IF/ICC	200ug	59670
CLSAF0018	Phospho-CCR5(Ser349) Antibody	40kDa	Human,	WB	200ug	59670
CLSAF0020	Phospho-PYK2(Tyr580) Antibody	135kDa	Human, Mouse, Rat	WB IHC	200ug	59670
CLSAF0021	Phospho-CDC25A(Ser75) Antibody	59kDa	Human, Mouse, Rat	WB IHC	200ug	59670
CLSAF0028	Phospho-EPHA2/3(Tyr588/596) Antibody	130kDa	Human, Mouse, Rat	WB IF/ICC	200ug	59670
CLSAF0029	Phospho-ERK8(Thr175+Tyr177) Antibody	60kDa	Human, Mouse,	WB	200ug	59670
CLSAF0030	Phospho-Retinoblastoma(Thr826) Antibody	110kDa	Human, Mouse, Rat	WB IF/ICC	200ug	59670
CLSAF0031	Phospho-HBP1(Ser402) Antibody	58kDa	Human,	WB	200ug	59670
CLSAF0033	Phospho-hnRPD(Ser83) Antibody	38kDa	Human, Mouse, Rat	WB IHC IF/ICC	200ug	59670
CLSAF0035	Phospho-eNOS(Ser615) Antibody	140kDa	Human, Mouse, Rat	WB	200ug	59670
CLSAF0037	Phospho-CD227/MUC1(Tyr1229) Antibody	170kDa	Human,	WB IHC IF/ICC	200ug	59670
CLSAF0042	Phospho-GR(Ser203) Antibody	86kDa	Human, Mouse,	WB	200ug	59670
CLSAF0044	Phospho-FER(Tyr402) Antibody	85kDa	Human, Mouse,	WB IHC	200ug	59670
CLSAF0046	Phospho-PAK3(Ser154) Antibody	72kDa	Human, Mouse, Rat	WB IHC	200ug	59670
CLSAF0047	Phospho-C-RAF(Ser301) Antibody	73kDa	Human, Mouse, Rat	WB	200ug	59670
CLSAF0048	Phospho-RIPK2(Ser176) Antibody	70kDa	Human, Mouse,	WB IHC	200ug	59670
CLSAF0049	Phospho-RIPK2(Ser176) Antibody	70kDa	Human, Mouse,	WB IHC	200ug	59670
CLSAF0050	Phospho-Retinoic Acid Receptor alpha (Ser77) Antibody	45kDa	Human, Mouse, Rat	WB IHC	200ug	59670
CLSAF0051	Phospho-DYN1(Ser778) Antibody	100kDa	Human, Mouse, Rat	WB	200ug	59670
CLSAF0054	Phospho-Paxillin(Ser178) Antibody	64kDa	Human, Mouse, Rat	WB	200ug	59670
CLSAF0055	Phospho-FANCG(Ser383) Antibody	69kDa	Human,	WB	200ug	59670
CLSAF0057	Phospho-BCRA1(Ser1457) Antibody	220kDa	Human,	WB	200ug	59670
CLSAF0058	Phospho-EP515(Tyr849) Antibody	98kDa	Human, Mouse, Rat	WB	200ug	59670
CLSAF0059	Phospho-Gab2(Tyr452) Antibody	75kDa	Human, Mouse, Rat	WB	200ug	59670
CLSAF0060	Phospho-MAPKAPK5(Thr182) Antibody	60kDa	Human, Mouse,	WB IHC	200ug	59670
CLSAF0061	Phospho-MAPKAPK5(Thr182) Antibody	60kDa	Human, Mouse,	WB IHC	200ug	59670
CLSAF0063	Phospho-HS1(Tyr378) Antibody	78kDa	Human,	WB	200ug	59670
CLSAF0064	Phospho-ALOX5(Ser523) Antibody	77kDa	Human, Rat	WB	200ug	59670
CLSAF0065	Phospho-VAV3(Tyr173) Antibody	100kDa	Human, Mouse,	WB	200ug	59670
CLSAF0077	PECAM-1 Antibody	82kDa	Human, Mouse	WB IHC IF/ICC	200ug	59670
CLSAF0080	M-CSF Receptor Antibody	108kDa	Human, Mouse, Rat	WB IHC	200ug	59670
CLSAF0083	Bax Antibody	21kDa	Human, Mouse, Rat	WB IF/ICC	200ug	59670
CLSAF0085	C/EBP-epsilon Antibody	34kDa	Human	WB IHC IF/ICC	200ug	59670
CLSAF0087	CD226/DNAM-1 Antibody	38kDa	Human, Mouse	WB IF/ICC	200ug	59670
CLSAF0088	Cyclin H Antibody	36kDa	Human, Mouse, Rat	WB IHC IF/ICC	200ug	59670
CLSAF0089	EPHA2/3/4 Antibody	130kDa	Human, Rat	WB IF/ICC	200ug	59670
CLSAF0091	Gz-alpha Antibody	41kDa	Human, Mouse, Rat	WB IHC	200ug	59670
CLSAF0092	hnRPD Antibody	38kDa	Human, Mouse, Rat	WB IHC IF/ICC	200ug	59670
CLSAF0093	IL-2Rbeta/CD122 Antibody	75kDa	Human, Mouse, Rat	WB IHC	200ug	59670
CLSAF0094	MCL1 Antibody	35kDa	Human, Mouse	WB	200ug	59670
CLSAF0096	eNOS Antibody	140kDa	Human, Mouse, Rat	WB	200ug	59670
CLSAF0097	14-3-3 beta/delta Antibody	28kDa	Human, Mouse, Rat	WB	200ug	59670
CLSAF0098	HSF 1 Antibody	55kDa	Human, Mouse	WB	200ug	59670
CLSAF0102	TTK Antibody	100kDa	Human, Mouse	WB IHC	200ug	59670
CLSAF0103	FRS2 Antibody	65kDa	Human, Mouse	WB	200ug	59670
CLSAF0106	Gab2 Antibody	97kDa	Human, Mouse, Rat	WB IHC	200ug	59670
CLSAF0108	APLF Antibody	57kDa	Human, Mouse	WB IHC	200ug	59670
CLSAF0109	Neuro D Antibody	36kDa	Human, Mouse, Rat	WB	200ug	59670
CLSAF0110	RAD17 Antibody	77kDa	Human, Mouse, Rat	WB	200ug	59670
CLSAF0111	RON Antibody	152kDa	Human, Mouse	WB	200ug	59670
CLSAF0115	Actin-pan Antibody	45kDa	Human, Mouse, Rat	WB IHC	200ug	59670
CLSAF0116	Annexin A6 Antibody	75kDa	Human	WB IHC IF/ICC	200ug	59670
CLSAF0117	APAF1 Antibody	27kDa	Human	WB IHC	200ug	59670
CLSAF0118	ARC Antibody	23kDa	Human	WB IHC	200ug	59670
CLSAF0119	Bak Antibody	25kDa	Human, Mouse	WB IHC	200ug	59670
CLSAF0120	Bax Antibody	21kDa	Human, Mouse, Rat	WB IHC IF	200ug	59670
CLSAF0121	BIM Antibody	25kDa,22kDa	Human, Mouse, Rat	WB IHC	200ug	59670
CLSAF0122	Caspase 10 Antibody	60kDa	Human	WB IHC IF/ICC	200ug	59670
CLSAF0123	CARD6 Antibody	116kDa	Human	WB IHC IF/ICC	200ug	59670
CLSAF0124	Catenin-gamma Antibody	82kDa	Human, Mouse, Rat	WB IHC	200ug	59670
CLSAF0125	Catenin-gamma Antibody	82kDa	Human, Mouse, Rat	WB IHC	200ug	59670
CLSAF0126	Caveolin-1 Antibody	25kDa	Human, Mouse, Rat	WB IF/ICC	200ug	59670
CLSAF0127	Claudin 1 Antibody	22kDa	Human, Mouse, Rat	WB IHC	200ug	59670
CLSAF0128	Claudin 2 Antibody	25kDa	Human, Mouse	WB IHC IF	200ug	59670
CLSAF0129	Claudin 3 Antibody	25kDa	Human, Mouse, Rat	WB IHC IF/ICC	200ug	59670
CLSAF0130	Claudin 5 Antibody	23kDa	Human, Mouse, Rat	WB IHC IF	200ug	59670
CLSAF0131	E-cadherin Antibody	120kDa	Human, Mouse, Rat	WB IHC IF/ICC	200ug	59670
CLSAF0132	Fos Antibody	50kDa	Human, Mouse, Rat	WB IHC	200ug	59670

Antibodies
HSN : 38220090

Cat#	Product Description	MW	Reactivity	Application	Pack Size	Unit Price
CLSAF0133	Claudin 10 Antibody	25kDa	Human, Mouse	WB	200ug	59670
CLSAF0134	Collagen I Antibody	129kDa	Human, Mouse, Rat	IHC IF/ICC	200ug	59670
CLSAF0135	Collagen II Antibody	140kDa	Human, Mouse, Rat	WB IHC IF/ICC	200ug	59670
CLSAF0136	Collagen III Antibody	138kDa	Human, Mouse, Rat	IHC IF/ICC	200ug	59670
CLSAF0137	Connexin 43 Antibody	43kDa	Human, Mouse, Rat	WB IHC IF/ICC	200ug	59670
CLSAF0138	Cox1 Antibody	70kDa	Human	WB IHC	200ug	59670
CLSAF0139	CREB-BP Antibody	265kDa	Human, Mouse	WB IHC IF/ICC	200ug	59670
CLSAF0140	Cullin 1 Antibody	90kDa	Human, Mouse	WB IHC IF/ICC	200ug	59670
CLSAF0141	Cullin 2 Antibody	82kDa,84kDa	Human, Mouse	WB IHC IF/ICC	200ug	59670
CLSAF0142	Cyclin A Antibody	53kDa	Human, Mouse, Rat	WB IHC IF/ICC	200ug	59670
CLSAF0143	Cyclin A1 Antibody	52kDa	Human, Mouse, Rat	WB IHC	200ug	59670
CLSAF0144	Cyclin E1 Antibody	49kDa	Human, Mouse, Rat	WB IHC IF/ICC	200ug	59670
CLSAF0145	Cyclin G Antibody	29kDa	Human, Mouse, Rat	WB IHC	200ug	59670
CLSAF0146	Cytochrome c Antibody	15kDa	Human, Mouse, Rat	WB IHC	200ug	59670
CLSAF0147	Desmin Antibody	55kDa	Human, Mouse, Rat	WB IHC	200ug	59670
CLSAF0148	DNA Polymerase beta Antibody	38kDa	Human, Mouse, Rat	WB IHC	200ug	59670
CLSAF0149	TFDP1 Antibody	55kDa	Human	WB IHC IF/ICC	200ug	59670
CLSAF0150	Dysferlin Antibody	240kDa	Human, Mouse	WB	200ug	59670
CLSAF0151	E2F4 Antibody	44kDa	Human, Mouse, Rat	WB IHC	200ug	59670
CLSAF0152	E2F6 Antibody	31kDa	Human, Mouse, Rat	WB IHC	200ug	59670
CLSAF0153	Collagen alpha 1 XVIII Antibody	178kDa	Human, Mouse,	IHC	200ug	59670
CLSAF0154	ERCC1 Antibody	36kDa	Human, Mouse	WB IHC	200ug	59670
CLSAF0155	ERK1/2 Antibody	42kDa,44kDa	Human, Mouse, Rat,Cow	WB IHC	200ug	59670
CLSAF0156	Factor VIII Antibody	300kDa	Human, Mouse	WB IHC	200ug	59670
CLSAF0157	FASL Antibody	33kDa	Human, Mouse	WB IHC	200ug	59670
CLSAF0158	FGFR1 Oncogene Partner Antibody	43kDa	Human, Mouse, Rat	WB IHC	200ug	59670
CLSAF0159	FGFR2 Antibody	92kDa	Human, Mouse, Rat	WB IHC	200ug	59670
CLSAF0160	FGFR3 Antibody	95kDa	Human, Mouse, Rat	WB IHC	200ug	59670
CLSAF0161	FLI1 Antibody	50kDa	Human, Mouse	WB IHC	200ug	59670
CLSAF0162	GABBR1 Antibody	110kDa	Human, Mouse, Rat	WB IHC	200ug	59670
CLSAF0163	GAD1 Antibody	67kDa	Human, Mouse, Rat	WB IHC	200ug	59670
CLSAF0164	Galectin 3 Antibody	27kDa	Human, Mouse, Rat	WB IHC IF/ICC	200ug	59670
CLSAF0165	GANP Antibody	218kDa	Human, Mouse	WB IHC	200ug	59670
CLSAF0166	Glucagon Antibody	25kDa	Human, Mouse, Rat	WB IF/ICC	200ug	59670
CLSAF0167	mGluR2/3 Antibody	96kDa,99kDa	Human, Mouse, Rat	WB IHC	200ug	59670
CLSAF0168	mGluR4 Antibody	100kDa	Human, Mouse, Rat	WB IHC	200ug	59670
CLSAF0169	GluR5 Antibody	100kDa	Human, Mouse, Rat	WB IHC	200ug	59670
CLSAF0170	mGluR6 Antibody	100kDa	Human	WB IHC	200ug	59670
CLSAF0171	mGluR7 Antibody	100kDa	Human, Mouse, Rat	WB IHC	200ug	59670
CLSAF0172	mGluR8 Antibody	100kDa	Human, Mouse, Rat	WB IHC	200ug	59670
CLSAF0173	GLUT1 Antibody	55kDa	Human, Mouse, Rat	WB IHC	200ug	59670
CLSAF0174	GLUT3 Antibody	54kDa	Human	WB IHC	200ug	59670
CLSAF0175	Granzyme B Antibody	28kDa	Human, Mouse, Rat	WB IHC	200ug	59670
CLSAF0176	GRP75 Antibody	75kDa	Human, Mouse, Rat	WB IHC IF/ICC	200ug	59670
CLSAF0177	hCG beta Antibody	20kDa	Human	WB IHC	200ug	59670
CLSAF0178	HDAC1 Antibody	55kDa	Human, Mouse, Rat	WB IHC IF/ICC	200ug	59670
CLSAF0179	HDAC10 Antibody	75kDa	Human, Mouse, Rat	WB IHC	200ug	59670
CLSAF0180	HDAC7 Antibody	105kDa	Human, Mouse	WB IHC	200ug	59670
CLSAF0181	HDAC9 Antibody	110kDa	Human	WB IHC IF/ICC	200ug	59670
CLSAF0182	NRG1 isoform-10 Antibody	44kDa	Human, Mouse, Rat	WB IHC	200ug	59670
CLSAF0183	HSP10 Antibody	10kDa	Human, Mouse, Rat	WB IHC IF/ICC	200ug	59670
CLSAF0184	HSP60 Antibody	68kDa	Human, Mouse, Rat	WB IHC IF/ICC	200ug	59670
CLSAF0185	Integrin beta-5 Antibody	88kDa	Human, Mouse, Rat	WB	200ug	59670
CLSAF0186	Involucrin Antibody	68kDa	Human	WB IHC	200ug	59670
CLSAF0187	COPS3 Antibody	47kDa	Human, Mouse, Rat	WB IF/ICC	200ug	59670
CLSAF0188	JM4 Antibody	20kDa	Human, Mouse, Rat	WB IHC	200ug	59670
CLSAF0189	Keratin 16 Antibody	52kDa	Human, Mouse, Rat	WB IHC	200ug	59670
CLSAF0190	Keratin 17 Antibody	48kDa	Human, Mouse, Rat	WB IHC IF/ICC	200ug	59670
CLSAF0191	Keratin 18 Antibody	46kDa	Human, Mouse, Rat	WB IHC IF/ICC	200ug	59670
CLSAF0192	Keratin 19 Antibody	44kDa	Human, Mouse, Rat	WB IHC	200ug	59670
CLSAF0193	Keratin 20 Antibody	49kDa	Human, Mouse, Rat	WB IHC	200ug	59670
CLSAF0194	Keratin 5 Antibody	62kDa	Human, Mouse, Rat	WB IHC	200ug	59670
CLSAF0195	Keratin 7 Antibody	51kDa	Human	WB IHC IF/ICC	200ug	59670
CLSAF0196	Keratin 8 Antibody	55kDa	Human, Mouse, Rat	WB IHC	200ug	59670
CLSAF0197	Keratin 10 Antibody	59kDa	Human, Mouse, Rat	WB IF/ICC	200ug	59670
CLSAF0198	Ki67 Antibody	358kDa	Human,	IHC IF/ICC	200ug	59670
CLSAF0199	iNOS Antibody	130kDa	Human	WB IHC IF/ICC	200ug	59670
CLSAF0200	Ku80 Antibody	70kDa,82kDa	Human	WB IHC IF/ICC	200ug	59670
CLSAF0201	Ku70 Antibody	70kDa	Human, Mouse, Rat	WB IHC IF/ICC	200ug	59670
CLSAF0202	Mammaglobin Antibody	20kDa	Human, Rat	WB IHC IF/ICC	200ug	59670

Antibodies

HSN : 38220090

Cat#	Product Description	MW	Reactivity	Application	Pack Size	Unit Price
CLSAF0203	Mammaglobin B Antibody	15kDa	Human	WB IHC	200ug	59670
CLSAF0204	MLANA Antibody	15kDa	Human	WB IHC	200ug	59670
CLSAF0205	MCL1 Antibody	37kDa,32kDa	Human, Mouse, Rat	WB IHC IF	200ug	59670
CLSAF0206	MCM2 Antibody	120kDa	Human, Mouse	WB IHC IF/ICC	200ug	59670
CLSAF0207	MCM5 Antibody	90kDa	Human, Mouse, Rat	WB IHC IF/ICC	200ug	59670
CLSAF0208	MDM2 Antibody	90kDa	Human, Mouse, Rat	WB IHC IF/ICC	200ug	59670
CLSAF0209	MMP1 Antibody	54kDa	Human	WB	200ug	59670
CLSAF0211	MMP11 Antibody	60kDa	Human, Mouse, Rat	WB IHC IF/ICC	200ug	59670
CLSAF0212	MMP14 Antibody	65kDa	Human, Mouse, Rat	WB IHC	200ug	59670
CLSAF0213	MMP15 Antibody	80kDa	Human, Mouse	WB	200ug	59670
CLSAF0214	MMP16 Antibody	69kDa	Human, Mouse, Rat	WB IHC	200ug	59670
CLSAF0215	MMP19 Antibody	57kDa	Human, Mouse	WB IHC	200ug	59670
CLSAF0216	MMP23 Antibody	44kDa	Human, Mouse, Rat	WB	200ug	59670
CLSAF0217	MMP3 Antibody	53kDa	Human, Mouse, Rat	WB IHC	200ug	59670
CLSAF0218	MMP7 Antibody	29kDa	Human, Mouse, Rat	WB IHC	200ug	59670
CLSAF0219	MMP8 Antibody	55kDa	Human, Mouse, Rat	WB IHC	200ug	59670
CLSAF0220	MMP9 Antibody	78kDa	Human	WB IHC	200ug	59670
CLSAF0221	NKX3.1 Antibody	38kDa	Human,	IHC	200ug	59670
CLSAF0222	NM23 Antibody	23kDa	Human, Mouse, Rat	WB	200ug	59670
CLSAF0223	NSE Antibody	47kDa	Human, Mouse, Rat	WB IHC IF/ICC	200ug	59670
CLSAF0224	OCT1 Antibody	76kDa	Human, Mouse	WB IHC	200ug	59670
CLSAF0225	OCT2 Antibody	52kDa	Human, Mouse	WB IF/ICC	200ug	59670
CLSAF0226	OCT3 Antibody	50kDa	Human, Mouse, Rat	WB IHC	200ug	59670
CLSAF0227	Osteopontin Antibody	60kDa	Human, Mouse, Rat	WB	200ug	59670
CLSAF0228	p16 INK Antibody	16kDa	Human, Mouse	WB	200ug	59670
CLSAF0229	p14 ARF Antibody	18kDa	Human	WB IHC IF/ICC	200ug	59670
CLSAF0230	p15 INK Antibody	14kDa	Human, Mouse, Rat	WB IHC IF/ICC	200ug	59670
CLSAF0231	PCAF Antibody	93kDa	Human, Mouse, Rat	WB IHC	200ug	59670
CLSAF0232	p50 Dynamitin Antibody	50kDa	Human, Mouse, Rat	WB	200ug	59670
CLSAF0233	p63 Antibody	77kDa	Human, Mouse, Rat	WB IF/ICC	200ug	59670
CLSAF0234	Parathyroid Hormone Antibody	16kDa	Human	WB	200ug	59670
CLSAF0235	Parkin Antibody	52kDa	Human, Mouse, Rat	WB IHC	200ug	59670
CLSAF0236	Cyclin L1 Antibody	60kDa	Human, Mouse, Rat	WB IHC	200ug	59670
CLSAF0237	Patched Antibody	160kDa	Human, Mouse	WB IHC	200ug	59670
CLSAF0238	Pax-5 Antibody	40kDa	Human, Mouse	WB	200ug	59670
CLSAF0239	PCNA Antibody	36kDa	Human, Mouse, Rat	WB IHC	200ug	59670
CLSAF0240	PDGFB Antibody	27kDa,22kDa	Human, Mouse, Rat	WB	200ug	59670
CLSAF0241	PDGFRalpha Antibody	140kDa	Human, Mouse, Rat	WB IHC IF/ICC	200ug	59670
CLSAF0242	Peripherin Antibody	55kDa	Human, Rat	WB IHC	200ug	59670
CLSAF0243	PGP9.5 Antibody	28kDa	Human, Mouse, Rat	WB IHC	200ug	59670
CLSAF0244	KCNC2 Antibody	70kDa	Human, Mouse, Rat	WB IHC	200ug	59670
CLSAF0245	Presenilin 1 Antibody	60kDa	Human	WB IHC	200ug	59670
CLSAF0246	KLK3 Antibody	34kDa	Human	WB IHC	200ug	59670
CLSAF0247	RASH/RASK/RASN Antibody	25kDa,21kDa	Human, Mouse, Rat	WB IHC	200ug	59670
CLSAF0248	RCBTB1 Antibody	58kDa	Human, Mouse	WB IHC	200ug	59670
CLSAF0249	Retinoic Acid Receptor beta Antibody	50kDa	Human, Mouse	WB IHC	200ug	59670
CLSAF0250	RIT1 Antibody	25kDa	Human, Mouse	WB	200ug	59670
CLSAF0251	S100 A1 Antibody	10kDa	Human, Mouse, Rat	WB IHC IF/ICC	200ug	59670
CLSAF0252	SHIP1 Antibody	133kDa	Human, Mouse, Rat	WB	200ug	59670
CLSAF0253	SHPS1 Antibody	55kDa	Human, Mouse, Rat	WB IHC	200ug	59670
CLSAF0254	SNAP25 Antibody	25kDa	Human, Mouse, Rat	WB IHC	200ug	59670
CLSAF0255	Sodium Channel-pan Antibody	230kDa	Human, Mouse, Rat	WB IHC	200ug	59670
CLSAF0256	CSTB Antibody	11kDa	Human, Rat	WB IHC IF/ICC	200ug	59670
CLSAF0257	Synaptophysin Antibody	38kDa	Human, Mouse, Rat	WB IHC IF	200ug	59670
CLSAF0258	Gamma-synuclein Antibody	20kDa	Human	WB IHC	200ug	59670
CLSAF0259	TGFR2 Antibody	65kDa	Human, Mouse, Rat	WB	200ug	59670
CLSAF0260	TGF beta2 Antibody	47kDa	Human, Mouse, Rat	IHC	200ug	59670
CLSAF0261	TGFB3 Antibody	13kDa	Human, Mouse, Rat	WB IHC	200ug	59670
CLSAF0262	TGF alpha Antibody	10kDa	Human, Mouse, Rat	WB IHC	200ug	59670
CLSAF0263	Thrombin Receptor Antibody	48kDa	Human	WB	200ug	59670
CLSAF0264	TIMP2 Antibody	24kDa	Human, Mouse, Rat	WB IF/ICC	200ug	59670
CLSAF0265	TIMP3 Antibody	25kDa	Human, Mouse, Rat	WB	200ug	59670
CLSAF0266	AOS1 Antibody	38kDa	Human, Mouse, Rat	WB IF/ICC	200ug	59670
CLSAF0267	CDK7 Antibody	39kDa	Human, Mouse	WB IHC	200ug	59670
CLSAF0268	EDD Antibody	309kDa	Human, Mouse	WB IHC	200ug	59670
CLSAF0269	HAT Antibody	49kDa	Human, Mouse, Rat	WB	200ug	59670
CLSAF0270	NCoR1 Antibody	270kDa	Human, Mouse	WB IHC	200ug	59670
CLSAF0271	NEDD8 Antibody	85kDa	Human, Mouse, Rat	WB IHC	200ug	59670
CLSAF0272	NYREN18 Antibody	70kDa	Human, Mouse	WB IHC	200ug	59670
CLSAF0273	PIAS2 Antibody	68kDa	Human, Mouse, Rat	WB	200ug	59670



Antibodies

HSN : 38220090

Cat#	Product Description	MW	Reactivity	Application	Pack Size	Unit Price
CLSAF0274	PIAS3 Antibody	68kDa	Human, Mouse, Rat	WB IHC	200ug	59670
CLSAF0275	SENP1 Antibody	73kDa	Human, Mouse	WB IHC	200ug	59670
CLSAF0276	SENP5 Antibody	86kDa	Human, Mouse	WB IHC	200ug	59670
CLSAF0277	SENP6 Antibody	126kDa	Human,	IHC	200ug	59670
CLSAF0278	SENP7 Antibody	112kDa	Human, Mouse	WB IHC	200ug	59670
CLSAF0279	SENP8 Antibody	27kDa	Human, Mouse, Rat	WB IHC	200ug	59670
CLSAF0280	Sumo1 Antibody	12kDa	Human, Mouse, Rat	WB IHC IF/ICC	200ug	59670
CLSAF0281	TIMP4 Antibody	26kDa	Human, Mouse, Rat	WB IHC	200ug	59670
CLSAF0282	TNFR1 Antibody	50kDa	Human, Mouse, Rat	IHC	200ug	59670
CLSAF0283	TOP2B Antibody	183kDa	Human, Mouse	WB IHC	200ug	59670
CLSAF0284	TRADD Antibody	34kDa	Human, Mouse	WB IHC	200ug	59670
CLSAF0285	Tubulin gamma Antibody	51kDa	Human, Mouse, Rat	WB IHC	200ug	59670
CLSAF0286	Tyrosinase Antibody	80kDa	Human	WB	200ug	59670
CLSAF0287	Uba2 Antibody	71kDa	Human	WB IHC	200ug	59670
CLSAF0288	UBE1L Antibody	112kDa	Human	WB IHC	200ug	59670
CLSAF0289	Ubiquitin Antibody	8kDa	Human, Mouse, Rat	IHC	200ug	59670
CLSAF0290	Urocortin Antibody	13kDa	Human, Mouse, Rat	IHC	200ug	59670
CLSAF0291	USF2 Antibody	40kDa	Human, Mouse, Rat	WB IHC	200ug	59670
CLSAF0292	Vimentin Antibody	53kDa	Human, Mouse, Rat	WB IHC	200ug	59670
CLSAF0293	RPL10 Antibody	25kDa	Human, Mouse, Rat	WB	200ug	59670
CLSAF0294	XPA Antibody	40kDa	Human, Mouse	WB IHC	200ug	59670
CLSAF0295	XPF Antibody	103kDa	Human, Mouse	WB	200ug	59670
CLSAF0296	XRCC1 Antibody	90kDa	Human, Mouse, Rat	WB IHC	200ug	59670
CLSAF0297	XRCC2 Antibody	32kDa	Human,	IHC	200ug	59670
CLSAF0298	XRCC3 Antibody	38kDa	Human	WB IHC	200ug	59670
CLSAF0299	XRCC4 Antibody	40kDa	Human	WB	200ug	59670
CLSAF0300	Ku70 Antibody	70kDa	Human, Mouse	WB IHC	200ug	59670
CLSAF0301	TM16J Antibody	90kDa	Human,	IHC IF/ICC	200ug	59670
CLSAF0302	NKX6.3 Antibody	34kDa	Human, Mouse	WB IF/ICC	200ug	59670
CLSAF0303	CLIM1 Antibody	36kDa	Human, Mouse, Rat	WB IHC IF/ICC	200ug	59670
CLSAF0304	TR10A Antibody	50kDa	Human	WB	200ug	59670
CLSAF0305	TAF4 Antibody	110kDa	Human, Mouse	WB	200ug	59670
CLSAF0306	VWA5A Antibody	86kDa	Human	WB	200ug	59670
CLSAF0307	TRIM38 Antibody	53kDa	Human, Mouse	WB	200ug	59670
CLSAF0308	DLGP1 Antibody	108kDa	Human, Mouse, Rat	WB IF/ICC	200ug	59670
CLSAF0309	CDKAP1 Antibody	20kDa	Human, Mouse	WB	200ug	59670
CLSAF0310	TP53I11 Antibody	18kDa	Human	WB IHC	200ug	59670
CLSAF0311	OVOL1 Antibody	33kDa	Human, Mouse	WB	200ug	59670
CLSAF0312	HEC1 Antibody	73kDa	Human, Mouse	WB IF/ICC	200ug	59670
CLSAF0313	TNFSF11 Antibody	40kDa	Human, Mouse	WB IHC IF/ICC	200ug	59670
CLSAF0314	BCKD Antibody	46kDa	Human, Mouse, Rat	WB IF/ICC	200ug	59670
CLSAF0315	KLF11 Antibody	55kDa	Human, Mouse	WB	200ug	59670
CLSAF0316	HGS Antibody	86kDa	Human, Mouse, Rat	WB IHC IF/ICC	200ug	59670
CLSAF0317	GAK Antibody	144kDa	Human, Mouse	WB	200ug	59670
CLSAF0318	PDZD2 Antibody	301kDa	Human, Mouse, Rat	IHC IF/ICC	200ug	59670
CLSAF0319	TBX3 Antibody	79kDa	Human, Mouse, Rat	WB	200ug	59670
CLSAF0320	TRIM24 Antibody	117kDa	Human, Mouse	WB IHC	200ug	59670
CLSAF0321	TRI18 Antibody	75kDa	Human, Mouse, Rat	WB IHC IF/ICC	200ug	59670
CLSAF0322	p73 Antibody	80kDa	Human	WB IHC	200ug	59670
CLSAF0323	Clock Antibody	95kDa	Human, Mouse, Rat	WB IHC	200ug	59670
CLSAF0324	PHF1 Antibody	62kDa	Human, Mouse, Rat	WB	200ug	59670
CLSAF0325	M3K13 Antibody	108kDa	Human, Mouse, Rat	WB	200ug	59670
CLSAF0326	ANP32C Antibody	26kDa	Human	WB	200ug	59670
CLSAF0327	TBX1 Antibody	43kDa	Human	WB IF/ICC	200ug	59670
CLSAF0328	TNFSF12 Antibody	27kDa	Human, Mouse	WB IHC IF/ICC	200ug	59670
CLSAF0329	TNF14 Antibody	26kDa	Human, Mouse,	IF/ICC	200ug	59670
CLSAF0330	AKAP10 Antibody	73kDa	Human, Mouse, Rat	WB	200ug	59670
CLSAF0331	HAIR Antibody	130kDa	Human,	IHC IF/ICC	200ug	59670
CLSAF0333	AKAP8 Antibody	76kDa	Human, Mouse, Rat	WB IHC IF/ICC	200ug	59670
CLSAF0334	AIRE Antibody	60kDa	Human, Mouse	WB IF/ICC	200ug	59670
CLSAF0335	EFNA2 Antibody	24kDa	Human, Mouse	WB	200ug	59670
CLSAF0336	MED14 Antibody	160kDa	Human, Mouse,	IHC IF/ICC	200ug	59670
CLSAF0337	ZNF387 Antibody	115kDa	Human	WB	200ug	59670
CLSAF0338	HBP1 Antibody	57kDa	Human, Mouse, Rat	WB	200ug	59670
CLSAF0339	DLX3 Antibody	45kDa	Human, Mouse	WB IHC	200ug	59670
CLSAF0340	ZIC1/2/3 Antibody	51kDa	Human, Mouse	WB IHC	200ug	59670
CLSAF0341	LMX1B Antibody	40kDa	Human, Mouse	WB	200ug	59670
CLSAF0342	REV3L Antibody	352kDa	Human, Mouse,	IHC	200ug	59670
CLSAF0343	Musculin Antibody	22kDa	Human, Mouse	WB IHC	200ug	59670
CLSAF0344	PFKFB2 Antibody	58kDa	Human, Mouse	WB	200ug	59670



Antibodies

HSN : 38220090

Cat#	Product Description	MW	Reactivity	Application	Pack Size	Unit Price
CLSAF0345	TBX10 Antibody	43kDa	Human	WB	200ug	59670
CLSAF0346	MED24 Antibody	110kDa	Human, Mouse, Rat	WB IF/ICC	200ug	59670
CLSAF0347	ADA2L Antibody	47kDa	Human, Mouse, Rat	WB	200ug	59670
CLSAF0348	TAF5L Antibody	66kDa	Human	WB	200ug	59670
CLSAF0349	CIB2 Antibody	21kDa	Human, Mouse, Rat	IHC	200ug	59670
CLSAF0350	CDKA2 Antibody	13kDa	Human, Mouse,	IHC	200ug	59670
CLSAF0351	NDUC2 Antibody	14kDa	Human, Rat	IHC	200ug	59670
CLSAF0352	TRIM16 Antibody	63kDa	Human,	IHC	200ug	59670
CLSAF0353	MBD3 Antibody	33kDa	Human, Mouse	WB	200ug	59670
CLSAF0354	PTTG1 Antibody	30kDa	Human	WB IF/ICC	200ug	59670
CLSAF0355	MOS Antibody	40kDa	Human	WB	200ug	59670
CLSAF0356	KAD1 Antibody	21kDa	Human, Mouse, Rat	IHC IF/ICC	200ug	59670
CLSAF0357	THRB Antibody	70kDa	Human, Mouse, Rat	WB IHC IF/ICC	200ug	59670
CLSAF0358	MYC Antibody	49kDa	Human, Mouse, Rat	WB IHC	200ug	59670
CLSAF0359	Histone H1.0 Antibody	20kDa	Human	WB	200ug	59670
CLSAF0360	CD271 Antibody	75kDa	Human, Mouse, Rat	WB IF/ICC	200ug	59670
CLSAF0361	KAPC A/B Antibody	38kDa	Human, Mouse, Rat	WB	200ug	59670
CLSAF0362	TSPAN8 Antibody	26kDa	Human	WB IF/ICC	200ug	59670
CLSAF0363	TFE3 Antibody	62kDa	Human, Mouse	WB IHC	200ug	59670
CLSAF0364	TNF-R2 Antibody	48kDa	Human, Mouse, Rat	WB IF/ICC	200ug	59670
CLSAF0365	TNF-R2 Antibody	48kDa	Human, Mouse, Rat	WB IF/ICC	200ug	59670
CLSAF0366	TAF1 Antibody	212kDa	Human, Mouse,	IHC	200ug	59670
CLSAF0367	GALK1 Antibody	45kDa	Human, Mouse, Rat	WB	200ug	59670
CLSAF0369	Smad4 Antibody	60kDa	Human, Mouse, Rat	WB	200ug	59670
CLSAF0372	FOXJ1 Antibody	60kDa	Human, Mouse, Rat	WB	200ug	59670
CLSAF0373	MKNK1 Antibody	51kDa	Human, Mouse	WB	200ug	59670
CLSAF0374	SERC1 Antibody	48kDa	Human, Mouse, Rat	WB	200ug	59670
CLSAF0375	NXF1 Antibody	70kDa	Human	WB	200ug	59670
CLSAF0377	BUB1 Antibody	122kDa	Human, Mouse,	IHC	200ug	59670
CLSAF0378	BARD1 Antibody	86kDa	Human	WB	200ug	59670
CLSAF0379	MUTYH Antibody	60kDa	Human, Mouse, Rat	WB IF/ICC	200ug	59670
CLSAF0380	PARK7 Antibody	20kDa,26kDa	Human, Mouse, Rat	WB	200ug	59670
CLSAF0382	RPS9 Antibody	23kDa	Human, Mouse, Rat	WB IF/ICC	200ug	59670
CLSAF0384	ANKRD26 Antibody	196kDa	Human,	IHC	200ug	59670
CLSAF0385	ABCF1 Antibody	95kDa	Human, Mouse, Rat	WB	200ug	59670
CLSAF0386	MAN1B1 Antibody	80kDa	Human	WB	200ug	59670
CLSAF0388	FYCO1 Antibody	166kDa	Human	WB	200ug	59670
CLSAF0389	NR4A3 Antibody	65kDa	Human, Mouse, Rat	WB	200ug	59670
CLSAF0391	PTPN22 Antibody	91kDa	Human, Mouse, Rat	WB	200ug	59670
CLSAF0395	CCR7 Antibody	43kDa	Human,	WB IF/ICC	200ug	59670
CLSAF0402	Alpha-synuclein Antibody	18kDa	Human, Mouse, Rat	WB	200ug	59670
CLSAF0410	ATP7B Antibody	157kDa	Human, Mouse, Rat	IHC IF/ICC	200ug	59670
CLSAF0411	CBX6 Antibody	44kDa	Human, Mouse, Rat	WB	200ug	59670
CLSAF0412	TFIP8 Antibody	23kDa	Human, Mouse,	WB IHC IF/ICC	200ug	59670
CLSAF0413	ATRX Antibody	282kDa	Human, Mouse,	IF/ICC	200ug	59670
CLSAF0415	TINF2 Antibody	53kDa	Human,	WB	200ug	59670
CLSAF0417	CIB3 Antibody	32kDa	Human, Mouse,	WB	200ug	59670
CLSAF0418	ADNP Antibody	124kDa	Human, Mouse,	WB	200ug	59670
CLSAF0421	MMTAG2 Antibody	34kDa	Human, Mouse, Rat	WB	200ug	59670
CLSAF0422	RBAK Antibody	85kDa	Human, Mouse,	WB	200ug	59670
CLSAF0424	TALL-2 Antibody	23kDa	Human, Mouse, Rat	WB IHC IF/ICC	200ug	59670
CLSAF0425	ATG4B Antibody	44kDa	Human, Mouse,	WB IHC	200ug	59670
CLSAF0426	FOXH1 Antibody	40kDa	Human, Mouse,	IF/ICC	200ug	59670
CLSAF0427	ZNF436 Antibody	50kDa	Human,	WB	200ug	59670
CLSAF0428	CD147 Antibody	48,36kDa	Human, Mouse, Rat	WB IHC	200ug	59670
CLSAF0429	Fibrillin-1 Antibody	312kDa	Human, Mouse, Rat	IHC	200ug	59670
CLSAF0430	DUS2L Antibody	55kDa	Human, Mouse,	WB IHC	200ug	59670
CLSAF0431	TNFRSF6B Antibody	32kDa	Human,	WB IHC IF/ICC	200ug	59670
CLSAF0433	MEF2C Antibody	51kDa	Human, Mouse,	IHC	200ug	59670
CLSAF0435	ETV4 Antibody	53kDa	Human, Mouse,	IHC	200ug	59670
CLSAF0436	EGFR Antibody	135,170kDa	Human, Mouse, Rat	WB	200ug	59670
CLSAF0437	DCLK3 Antibody	73kDa	Human,	IHC	200ug	59670
CLSAF0438	TUBGCP3 Antibody	105kDa	Human, Mouse,	IHC	200ug	59670
CLSAF0440	MED17 Antibody	73kDa	Human, Mouse,	WB	200ug	59670
CLSAF0441	NPM Antibody	37kDa	Human, Mouse, Rat	WB	200ug	59670
CLSAF0442	BHLHB3 Antibody	50kDa	Human, Mouse, Rat	WB	200ug	59670
CLSAF0443	CEBPB Antibody	49kDa	Human, Mouse,	WB	200ug	59670
CLSAF0444	MTA1 Antibody	80kDa	Human, Mouse, Rat	WB	200ug	59670
CLSAF0445	GAS41 Antibody	40kDa	Human, Mouse,	WB	200ug	59670
CLSAF0446	FKBPL Antibody	38kDa	Human, Mouse, Rat	WB	200ug	59670



Antibodies

HSN : 38220090

Cat#	Product Description	MW	Reactivity	Application	Pack Size	Unit Price
CLSAF0448	C1orf57 Antibody	21kDa	Human,	WB	200ug	59670
CLSAF0449	MAP3K3 Antibody	71kDa	Human, Mouse,	WB	200ug	59670
CLSAF0450	RHBT2 Antibody	83kDa	Human, Mouse,	WB	200ug	59670
CLSAF0453	TRIM3 Antibody	81kDa	Human, Mouse, Rat	WB IHC IF/ICC	200ug	59670
CLSAF0454	ATF6B Antibody	76kDa	Human,	WB	200ug	59670
CLSAF0455	LDOC1L Antibody	24kDa	Human, Mouse,	WB	200ug	59670
CLSAF0456	TACC1 Antibody	87kDa	Human, Mouse,	WB IF/ICC	200ug	59670
CLSAF0461	MAP3K6 Antibody	142kDa	Human, Mouse,	IHC	200ug	59670
CLSAF0462	YTHDF1 Antibody	61kDa	Human, Mouse, Rat	WB	200ug	59670
CLSAF0463	ES8L2 Antibody	81kDa	Human, Mouse,	WB	200ug	59670
CLSAF0464	ZNF498 Antibody	30kDa	Human,	WB	200ug	59670
CLSAF0465	MUC13 Antibody	50kDa	Human,	WB IHC IF/ICC	200ug	59670
CLSAF0468	NADAP Antibody	85kDa	Human, Mouse,	WB	200ug	59670
CLSAF0469	MN1 Antibody	135kDa	Human,	WB	200ug	59670
CLSAF0473	Cytochrome P450 26A1 Antibody	56kDa	Human, Mouse, Rat	WB	200ug	59670
CLSAF0475	ECRG4 Antibody	17kDa	Human, Mouse,	IHC IF/ICC	200ug	59670
CLSAF0480	EGR2 Antibody	50kDa	Human, Mouse, Rat	WB	200ug	59670
CLSAF0481	hnRNP M Antibody	85,78kDa	Human, Mouse, Rat	WB IHC IF/ICC	200ug	59670
CLSAF0482	5-HT-1A Antibody	46kDa	Human, Mouse, Rat	WB	200ug	59670
CLSAF0483	ELF1 Antibody	67kDa	Human,	WB IF/ICC	200ug	59670
CLSAF0485	PLCH Antibody	48kDa	Human, Mouse, Rat	WB IF/ICC	200ug	59670
CLSAF0486	LRAT Antibody	27kDa	Human, Mouse, Rat	WB IHC IF/ICC	200ug	59670
CLSAF0487	THR1 Antibody	53kDa	Human, Mouse, Rat	WB IHC	200ug	59670
CLSAF0490	XRN2 Antibody	108kDa	Human, Mouse,	WB IHC	200ug	59670
CLSAF0491	NT5C3 Antibody	38kDa	Human, Mouse,	WB IHC	200ug	59670
CLSAF0492	MAGI2 Antibody	159kDa	Human, Mouse, Rat	WB	200ug	59670
CLSAF0493	KITH_EBV Antibody	67kDa	Human,	WB	200ug	59670
CLSAF0497	MAST3 Antibody	143kDa	Human, Mouse,	WB	200ug	59670
CLSAF0498	SUPT3H Antibody	50kDa	Human,	WB	200ug	59670
CLSAF0499	LASS4 Antibody	46kDa	Human,	WB IHC	200ug	59670
CLSAF0500	TUSC2 Antibody	12kDa	Human, Mouse,	WB	200ug	59670
CLSAF0502	PKCB1 Antibody	132kDa	Human,	WB	200ug	59670
CLSAF0504	Maf Antibody	41kDa	Human, Mouse, Rat	WB	200ug	59670
CLSAF0505	SKP2/p45 Antibody	47kDa	Human,	WB IHC IF/ICC	200ug	59670
CLSAF0507	Dyskerin Antibody	57kDa	Human, Mouse, Rat	WB IF/ICC	200ug	59670
CLSAF0508	VPS72 Antibody	41kDa	Human, Mouse,	WB IHC	200ug	59670
CLSAF0509	AL2S7 Antibody	46kDa	Human, Mouse,	WB	200ug	59670
CLSAF0510	Collagen IV Antibody	160kDa	Human, Mouse,	WB IHC	200ug	59670
CLSAF0511	ZNF225 Antibody	82kDa	Human,	WB	200ug	59670
CLSAF0512	MEKKK 4 Antibody	142kDa	Human, Mouse,	WB IF/ICC	200ug	59670
CLSAF0514	ARMX3 Antibody	38kDa	Human, Mouse, Rat	WB IHC IF/ICC	200ug	59670
CLSAF0516	DIRA1 Antibody	22kDa	Human,	WB	200ug	59670
CLSAF0517	ADPGK Antibody	47kDa	Human, Mouse, Rat	WB	200ug	59670
CLSAF0520	Actin-gamma2 Antibody	45kDa	Human, Mouse, Rat	WB IHC	200ug	59670
CLSAF0521	Claudin 7 Antibody	22kDa	Human, Mouse, Rat	WB IHC	200ug	59670
CLSAF0522	DUSP16 Antibody	73kDa	Human, Mouse,	WB IF/ICC	200ug	59670
CLSAF0524	Tubulin alpha Antibody	50kDa	Human, Mouse, Rat	WB IHC IF/ICC	200ug	59670
CLSAF0525	FKRP Antibody	50kDa	Human, Mouse, Rat	WB	200ug	59670
CLSAF0526	ILKAP Antibody	45kDa	Human, Mouse, Rat	WB IHC	200ug	59670
CLSAF0527	FIR Antibody	119kDa	Human, Mouse,	WB	200ug	59670
CLSAF0528	NARG1 Antibody	100kDa	Human, Mouse,	WB	200ug	59670
CLSAF0529	AKAP3 Antibody	94kDa	Human, Mouse,	IF/ICC	200ug	59670
CLSAF0530	EFNA4 Antibody	95kDa	Human, Mouse,	WB	200ug	59670
CLSAF0531	TFAM Antibody	29kDa	Human,	IHC IF/ICC	200ug	59670
CLSAF0534	HNF4alpha /gamma Antibody	52kDa	Human, Mouse, Rat	WB	200ug	59670
CLSAF0535	AP-2 Antibody	49kDa	Human, Mouse, Rat	WB IHC	200ug	59670
CLSAF0539	CDCP1 Antibody	90kDa	Human, Mouse,	WB IF/ICC	200ug	59670
CLSAF0541	ADCK1 Antibody	61kDa	Human, Mouse,	WB	200ug	59670
CLSAF0543	SGOL1 Antibody	64kDa	Human,	WB	200ug	59670
CLSAF0547	APC Antibody	310kDa	Human, Mouse, Rat	WB IHC	200ug	59670
CLSAF0548	TGM2 Antibody	77kDa	Human, Mouse,	WB IHC	200ug	59670
CLSAF0550	DNA-PK Antibody	450kDa	Human, Mouse,	WB IHC IF/ICC	200ug	59670
CLSAF0551	DCP1A Antibody	75kDa	Human, Mouse,	WB	200ug	59670
CLSAF0552	IRX2 Antibody	50kDa	Human,	WB IHC IF/ICC	200ug	59670
CLSAF0553	AZ12 Antibody	48kDa	Human, Mouse, Rat	WB	200ug	59670
CLSAF0554	BCAR3 Antibody	92kDa	Human,	WB IHC	200ug	59670
CLSAF0555	ZNF682 Antibody	58kDa	Human,	WB	200ug	59670
CLSAF0560	EFNA5 Antibody	25kDa	Human, Mouse, Rat	WB IHC IF/ICC	200ug	59670
CLSAF0561	PIAS1 Antibody	72kDa	Human, Mouse,	WB IHC	200ug	59670
CLSAF0562	MAPK3 Antibody	42kDa	Human, Mouse, Rat	WB IHC	200ug	59670

Antibodies
HSN : 38220090

Cat#	Product Description	MW	Reactivity	Application	Pack Size	Unit Price
CLSAF0563	MORF4L1 Antibody	41kDa	Human, Mouse,	WB IF/ICC	200ug	59670
CLSAF0564	MRC2 Antibody	167kDa	Human, Mouse, Rat	WB IHC IF/ICC	200ug	59670
CLSAF0566	PRDM12 Antibody	40kDa	Human, Mouse,	WB	200ug	59670
CLSAF0567	PKNOX2 Antibody	55kDa	Human, Mouse,	WB	200ug	59670
CLSAF0568	HEXIM1 Antibody	40kDa	Human, Mouse, Rat	WB IF/ICC	200ug	59670
CLSAF0569	GCKR Antibody	68kDa	Human, Mouse, Rat	WB	200ug	59670
CLSAF0570	TRIP13 Antibody	48kDa	Human, Mouse, Rat	WB	200ug	59670
CLSAF0571	MAST2 Antibody	196kDa	Human, Mouse,	WB	200ug	59670
CLSAF0572	STRAD Antibody	46kDa	Human, Mouse,	WB	200ug	59670
CLSAF0573	Collagen XIV alpha 1 Antibody	193kDa	Human, Mouse,	IHC IF/ICC	200ug	59670
CLSAF0574	STEAP4 Antibody	51kDa	Human,	IHC IF/ICC	200ug	59670
CLSAF0576	ZNF337 Antibody	86kDa	Human,	WB	200ug	59670
CLSAF0577	MMP2 Antibody	74kDa	Human, Mouse, Rat	WB	200ug	59670
CLSAF0578	COX19 Antibody	10kDa	Human, Mouse,	IHC	200ug	59670
CLSAF0579	DMPK Antibody	70kDa	Human,	WB	200ug	59670
CLSAF0580	SFXN4 Antibody	37kDa	Human,	WB	200ug	59670
CLSAF0581	MAGE-1 Antibody	34kDa	Human,	WB IHC	200ug	59670
CLSAF0582	Collagen Va1pha 1 Antibody	200kDa	Human,	WB IHC IF/ICC	200ug	59670
CLSAF0585	HDAC5 Antibody	124kDa	Human, Mouse, Rat	WB IHC IF/ICC	200ug	59670
CLSAF0586	HSP40 Antibody	45kDa	Human, Mouse, Rat	WB IHC IF/ICC	200ug	59670
CLSAF0587	ITPK1 Antibody	50kDa	Human, Mouse,	WB	200ug	59670
CLSAF0588	POFUT2 Antibody	49kDa	Human, Mouse,	IHC	200ug	59670
CLSAF0589	NAB2 Antibody	56kDa	Human, Mouse,	WB IHC	200ug	59670
CLSAF0592	TUSC3 Antibody	39kDa	Human, Mouse, Rat	WB IF/ICC	200ug	59670
CLSAF0593	Gastrin Antibody	12kDa	Human, Mouse, Rat	WB IHC IF/ICC	200ug	59670
CLSAF0594	HDAC6 Antibody	135kDa	Human, Mouse,	WB IHC	200ug	59670
CLSAF0595	TF2H2 Antibody	62kDa	Human, Mouse, Rat	WB	200ug	59670
CLSAF0596	MLK4 Antibody	110kDa	Human,	WB	200ug	59670
CLSAF0597	NRIP2 Antibody	25kDa	Human, Mouse,	IHC	200ug	59670
CLSAF0598	Collagen XIIIalpha 1 Antibody	70kDa	Human, Mouse,	WB	200ug	59670
CLSAF0600	DOK3 Antibody	58kDa	Human, Mouse,	WB	200ug	59670
CLSAF0601	COX11 Antibody	31kDa	Human, Mouse,	WB	200ug	59670
CLSAF0602	FOXJ3 Antibody	68kDa	Human, Mouse,	IHC	200ug	59670
CLSAF0603	AKAP14 Antibody	23kDa	Human,	WB IF/ICC	200ug	59670
CLSAF0604	ELOVL4 Antibody	37kDa	Human, Mouse,	WB	200ug	59670
CLSAF0606	UBXD5 Antibody	57kDa	Human,	WB IHC	200ug	59670
CLSAF0607	DYR1B Antibody	70kDa	Human, Mouse,	WB	200ug	59670
CLSAF0608	CDK11 Antibody	90kDa	Human,	WB	200ug	59670
CLSAF0609	FHIT Antibody	16kDa	Human,	WB IHC IF/ICC	200ug	59670
CLSAF0611	DGKH Antibody	134kDa	Human, Mouse,	IHC IF/ICC	200ug	59670
CLSAF0614	Smad1/5/9 Antibody	56kDa	Human, Mouse, Rat	WB	200ug	59670
CLSAF0615	PFKFB1/4 Antibody	54kDa	Human, Mouse, Rat	WB	200ug	59670
CLSAF0616	CKS2 Antibody	9kDa	Human, Mouse,	IHC	200ug	59670
CLSAF0617	HSP105 Antibody	100kDa	Human, Mouse,	WB IHC IF/ICC	200ug	59670
CLSAF0619	GCYB1 Antibody	70kDa	Human, Mouse, Rat	WB IHC	200ug	59670
CLSAF0620	p18 INK Antibody	18kDa	Human, Mouse,	WB IHC	200ug	59670
CLSAF0621	TUBGCP5 Antibody	118kDa	Human, Mouse, Rat	WB	200ug	59670
CLSAF0623	Collagen XVIIIalpha 1 Antibody	178kDa	Human, Mouse,	IHC IF/ICC	200ug	59670
CLSAF0624	CD69 Antibody	23kDa	Human, Mouse, Rat	WB	200ug	59670
CLSAF0626	COX17 Antibody	7kDa	Human, Mouse, Rat	WB IHC	200ug	59670
CLSAF0627	EPHA7 Antibody	112kDa	Human, Mouse, Rat	WB	200ug	59670
CLSAF0628	CCDC99 Antibody	70kDa	Human,	WB	200ug	59670
CLSAF0629	GADD153 Antibody	26kDa	Human, Mouse, Rat	WB IHC IF/ICC	200ug	59670
CLSAF0630	TNAP2 Antibody	72kDa	Human, Mouse,	IHC IF/ICC	200ug	59670
CLSAF0631	5-HT-5A Antibody	40kDa	Human,	WB	200ug	59670
CLSAF0632	FAKD1 Antibody	97kDa	Human, Mouse,	WB	200ug	59670
CLSAF0633	ZNF174 Antibody	46kDa	Human,	WB IF/ICC	200ug	59670
CLSAF0635	NDF2 Antibody	48kDa	Human, Mouse, Rat	WB	200ug	59670
CLSAF0636	p97 MAPK Antibody	85kDa	Human, Mouse, Rat	WB IF/ICC	200ug	59670
CLSAF0637	Cytochrome P450 2B6 Antibody	56kDa	Human,	WB	200ug	59670
CLSAF0638	DGKD Antibody	135kDa	Human,	WB	200ug	59670
CLSAF0639	Nrf2 Antibody	68kDa	Human, Mouse, Rat	WB IHC IF/ICC	200ug	59670
CLSAF0640	IF3EI Antibody	67kDa	Human, Mouse,	WB	200ug	59670
CLSAF0643	CERKL Antibody	63kDa	Human,	WB	200ug	59670
CLSAF0644	HOXD12 Antibody	28kDa	Human, Mouse,	WB	200ug	59670
CLSAF0647	ZNF187 Antibody	55kDa	Human,	WB IF/ICC	200ug	59670
CLSAF0648	TM16G Antibody	105kDa	Human,	IHC IF/ICC	200ug	59670
CLSAF0651	AKAP2 Antibody	96kDa	Human,	WB	200ug	59670
CLSAF0652	STEAP3 Antibody	54kDa	Human, Mouse, Rat	WB IF/ICC	200ug	59670
CLSAF0653	14-3-3 δ Antibody	28kDa	Human, Mouse, Rat	WB	200ug	59670



Antibodies

HSN : 38220090

Cat#	Product Description	MW	Reactivity	Application	Pack Size	Unit Price
CLSAF0654	RBM26 Antibody	113kDa	Human, Mouse,	WB	200ug	59670
CLSAF0657	RNF144A Antibody	30kDa	Human, Mouse,	WB	200ug	59670
CLSAF0659	TBX22 Antibody	58kDa	Human,	WB	200ug	59670
CLSAF0661	DAK Antibody	59kDa	Human, Mouse, Rat	WB	200ug	59670
CLSAF0663	COX42 Antibody	20kDa	Human, Mouse, Rat	WB IF/ICC	200ug	59670
CLSAF0664	GPRIN1 Antibody	102kDa	Human,	WB	200ug	59670
CLSAF0665	DLEC1 Antibody	195kDa	Human,	IHC IF/ICC	200ug	59670
CLSAF0666	ALPK2 Antibody	210kDa	Human,	IHC	200ug	59670
CLSAF0668	PHLA2 Antibody	17kDa	Human,	IHC	200ug	59670
CLSAF0669	RAD18 Antibody	56kDa	Human, Rat	WB	200ug	59670
CLSAF0670	ELOVL1 Antibody	35kDa	Human, Mouse,	WB	200ug	59670
CLSAF0673	HAND1 Antibody	23kDa	Human, Mouse, Rat	IF/ICC	200ug	59670
CLSAF0674	p300 Antibody	264kDa	Human,	WB IHC	200ug	59670
CLSAF0675	CDKL4 Antibody	36kDa	Human,	WB IHC IF/ICC	200ug	59670
CLSAF0676	ERGI3 Antibody	43kDa	Human, Mouse,	WB IF/ICC	200ug	59670
CLSAF0677	ANKRD1 Antibody	36kDa	Human, Mouse, Rat	WB	200ug	59670
CLSAF0678	SURF1 Antibody	30kDa	Human, Mouse, Rat	WB	200ug	59670
CLSAF0679	NCK2 Antibody	42kDa	Human, Mouse,	IHC	200ug	59670
CLSAF0681	DOK7 Antibody	60kDa	Human, Mouse,	WB IHC IF/ICC	200ug	59670
CLSAF0682	EPN2 Antibody	68kDa	Human, Mouse, Rat	WB	200ug	59670
CLSAF0683	KAD6 Antibody	20kDa	Human, Mouse, Rat	WB	200ug	59670
CLSAF0684	ZNF287 Antibody	90kDa	Human,	WB IHC	200ug	59670
CLSAF0685	AAK1 Antibody	94kDa	Human, Mouse, Rat	WB	200ug	59670
CLSAF0686	Cytochrome P450 2U1 Antibody	61kDa	Human, Mouse, Rat	WB	200ug	59670
CLSAF0688	KSR2 Antibody	108kDa	Human, Mouse,	WB IF/ICC	200ug	59670
CLSAF0690	IRAK3 Antibody	68kDa	Human,	WB IHC IF/ICC	200ug	59670
CLSAF0691	TAF6L Antibody	68kDa	Human, Mouse,	WB	200ug	59670
CLSAF0692	IRF4 Antibody	45kDa	Human, Mouse,	WB	200ug	59670
CLSAF0693	MARK4 Antibody	82kDa	Human, Mouse,	IF/ICC	200ug	59670
CLSAF0696	ALDOC Antibody	39kDa	Human, Mouse, Rat	IHC	200ug	59670
CLSAF0700	EPN1 Antibody	85kDa	Human, Mouse, Rat	WB	200ug	59670
CLSAF0703	TPD54 Antibody	22kDa	Human, Mouse, Rat	WB	200ug	59670
CLSAF0704	STON1 Antibody	83kDa	Human,	WB	200ug	59670
CLSAF0705	FOXL1 Antibody	36kDa	Human,	WB	200ug	59670
CLSAF0706	TTC23 Antibody	50kDa	Human,	WB	200ug	59670
CLSAF0707	PSMD2 Antibody	100kDa	Human, Mouse, Rat	WB	200ug	59670
CLSAF0710	ASF1A Antibody	23kDa	Human, Mouse,	WB	200ug	59670
CLSAF0711	GAD1/2 Antibody	65kDa	Human, Mouse,	WB IHC	200ug	59670
CLSAF0712	GASP1 Antibody	156kDa	Human,	IHC IF/ICC	200ug	59670
CLSAF0713	Cytochrome P450 2J2 Antibody	50kDa	Human,	WB IHC IF/ICC	200ug	59670
CLSAF0719	Collagen Xlalpha 1 Antibody	181kDa	Human, Mouse,	WB	200ug	59670
CLSAF0720	CRBP III Antibody	15kDa	Human,	IHC IF/ICC	200ug	59670
CLSAF0721	ATPBD3 Antibody	36kDa	Human,	WB	200ug	59670
CLSAF0722	BATF Antibody	14kDa	Human, Mouse,	IHC	200ug	59670
CLSAF0723	SPR1 Antibody	41kDa	Human, Mouse,	WB	200ug	59670
CLSAF0724	SIX6 Antibody	28kDa	Human, Mouse, Rat	WB IF/ICC	200ug	59670
CLSAF0725	GK2 Antibody	61kDa	Human,	WB	200ug	59670
CLSAF0726	MOBL3 Antibody	26kDa	Human, Mouse, Rat	WB	200ug	59670
CLSAF0729	GRP78 Antibody	75kDa	Human, Mouse, Rat	WB IHC IF/ICC	200ug	59670
CLSAF0730	MOL1A Antibody	25kDa	Human, Mouse,	WB	200ug	59670
CLSAF0731	MAST4 Antibody	36kDa	Human, Mouse,	WB IHC IF/ICC	200ug	59670
CLSAF0732	STA13 Antibody	125kDa	Human, Mouse,	WB	200ug	59670
CLSAF0733	HDAC3 Antibody	50kDa	Human, Mouse, Rat	WB IHC IF/ICC	200ug	59670
CLSAF0735	GRP94 Antibody	92kDa	Human, Mouse,	WB IHC IF/ICC	200ug	59670
CLSAF0736	Keratin 14 Antibody	52kDa	Human, Mouse, Rat	WB IHC IF/ICC	200ug	59670
CLSAF0737	TTF2 Antibody	34kDa	Human, Mouse, Rat	WB	200ug	59670
CLSAF0738	Fibronectin 1 Antibody	260kDa	Human, Mouse, Rat	WB IHC	200ug	59670
CLSAF0739	FAP-1 Antibody	88kDa	Human, Mouse, Rat	WB IHC	200ug	59670
CLSAF0741	Collagen Xlalpha 1 Antibody	333kDa	Human,	IHC IF/ICC	200ug	59670
CLSAF0744	Cytochrome P450 2C19 Antibody	56kDa	Human,	WB	200ug	59670
CLSAF0748	PFDN1 Antibody	14kDa	Human, Mouse,	WB	200ug	59670
CLSAF0750	Claudin 11 Antibody	20kDa	Human, Mouse, Rat	WB	200ug	59670
CLSAF0753	ZNF265 Antibody	34kDa	Human, Mouse, Rat	WB IF/ICC	200ug	59670
CLSAF0758	ERD23 Antibody	28kDa	Human, Mouse,	WB	200ug	59670
CLSAF0760	GABRG1 Antibody	54kDa	Human, Mouse, Rat	WB	200ug	59670
CLSAF0761	Cofilin Antibody	19kDa	Human, Mouse, Rat	WB	200ug	59670
CLSAF0762	COX6C Antibody	32kDa	Human, Mouse, Rat	WB IF/ICC	200ug	59670
CLSAF0767	DOK6 Antibody	43kDa	Human, Mouse,	WB IF/ICC	200ug	59670
CLSAF0769	BCL-2 Antibody	28kDa	Human,	WB IHC	200ug	59670
CLSAF0770	MRRF Antibody	28kDa	Human, Mouse, Rat	WB IHC	200ug	59670

Antibodies
HSN : 38220090

Cat#	Product Description	MW	Reactivity	Application	Pack Size	Unit Price
CLSAF0774	HSP90A Antibody	85kDa	Human, Mouse, Rat	WB IHC IF/ICC	200ug	59670
CLSAF0777	Rabphilin 3A Antibody	75kDa	Human, Mouse, Rat	WB IHC IF/ICC	200ug	59670
CLSAF0778	CDC2 Antibody	34kDa	Human, Mouse, Rat	WB	200ug	59670
CLSAF0779	MOK Antibody	48kDa	Human,	WB IHC	200ug	59670
CLSAF0786	PSMD2 Antibody	100kDa	Human, Mouse, Rat	WB	200ug	59670
CLSAF0790	Keratin 15 Antibody	50kDa	Human, Mouse, Rat	WB IHC	200ug	59670
CLSAF0791	AKT1/3 Antibody	50,56kDa	Human, Mouse, Rat	WB	200ug	59670
CLSAF0792	ZNF148 Antibody	89kDa	Human, Mouse, Rat	WB IHC	200ug	59670
CLSAF0793	TOP2A Antibody	174kDa	Human,	WB IHC	200ug	59670
CLSAF0795	CTBP1 Antibody	48kDa	Human, Mouse, Rat	WB IHC	200ug	59670
CLSAF0799	PPP1R2 Antibody	25kDa	Human, Mouse, Rat	WB IHC	200ug	59670
CLSAF0807	Phospho-CTBP1(Ser422) Antibody	48kDa	Human, Mouse, Rat	WB IHC	200ug	59670
CLSAF0809	GFRA4 Antibody	30kDa	Human,	WB	200ug	59670
CLSAF0818	MAP3K4 Antibody	181kDa	Human, Mouse,	IHC	200ug	59670
CLSAF0819	RNF14 Antibody	50kDa	Human, Mouse, Rat	WB	200ug	59670
CLSAF0822	SUPT16H Antibody	119kDa	Human, Mouse,	WB	200ug	59670
CLSAF0823	Phospho-NMDAR1(Ser897) Antibody	120kDa	Human, Mouse, Rat	WB IHC	200ug	59670
CLSAF0825	Phospho-APC(Ser2054) Antibody	311kDa	Human,	WB IHC	200ug	59670
CLSAF0827	TRHR Antibody	50kDa	Human, Mouse, Rat	WB IF/ICC	200ug	59670
CLSAF0828	Nibrin Antibody	85kDa	Human,	WB IF/ICC	200ug	59670
CLSAF0829	GK Antibody	57kDa	Human, Mouse, Rat	WB IF/ICC	200ug	59670
CLSAF0830	Phospho-Nibrin(Ser278) Antibody	85kDa	Human,	WB IF/ICC	200ug	59670
CLSAF0831	Syndecan4 Antibody	22kDa	Human, Mouse, Rat,	WB IHC IF/ICC	200ug	59670
CLSAF0832	Phospho-AKT1(Thr308) Antibody	56-60kDa	Human, Mouse, Rat	WB	200ug	59670
CLSAF0833	MAPK1/3 Antibody	41kDa	Human, Mouse, Rat	WB	200ug	59670
CLSAF0835	MAPKAPK5 Antibody	60kDa	Human, Mouse,	WB	200ug	59670
CLSAF0836	AKT1 Antibody	55kDa	Human, Mouse, Rat	WB	200ug	59670
CLSAF0837	C-RAF Antibody	73kDa	Human, Mouse, Rat	WB	200ug	59670
CLSAF0841	Phospho-BTK(Tyr223) Antibody	80kDa	Human, Mouse, Rat	WB	200ug	59670
CLSAF0842	SRF Antibody	55kDa	Human, Mouse,	WB	200ug	59670
CLSAF0843	FER Antibody	85kDa	Human, Mouse,	WB	200ug	59670
CLSAF0844	Pim-1 Antibody	50kDa	Human, Mouse, Rat	WB	200ug	59670
CLSAF0854	RPL31 Antibody	14kDa	Human, Mouse, Rat	IHC	200ug	59670
CLSAF0861	CBP Antibody	265kDa	Human, Mouse, Rat	WB IHC IF/ICC	200ug	59670
CLSAF0862	Histone H3 Antibody	17kDa	Human, Mouse, Rat	WB IF/ICC	200ug	59670
CLSAF0863	Histone H3 Antibody	17kDa	Human, Mouse, Rat	WB IHC IF/ICC	200ug	59670
CLSAF0865	p53 Antibody	53kDa	Human, Mouse, Rat	WB IHC IF/ICC	200ug	59670
CLSAF0866	Histone H2B Antibody	14kDa	Human, Mouse,	WB IHC IF/ICC	200ug	59670
CLSAF0872	Histone H4 Antibody	11kDa	Human, Mouse, Rat	WB IHC IF/ICC	200ug	59670
CLSAF0873	Histone H2B Antibody	14kDa	Human, Mouse,	WB IHC	200ug	59670
CLSAF0874	NF-κB p65 Antibody	65kDa	Human, Mouse,	WB IHC IF/ICC	200ug	59670
CLSAF0875	Histone H2A Antibody	14kDa	Human, Mouse, Rat	IHC	200ug	59670
CLSAF0876	Histone H1 Antibody	21kDa	Human,	WB IF/ICC	200ug	59670
CLSAF0877	p53 Antibody	53kDa	Human, Mouse, Rat	WB	200ug	59670
CLSAF0878	Histone H4 Antibody	11kDa	Human, Mouse, Rat	WB IHC IF/ICC	200ug	59670
CLSAF0879	p53 Antibody	53kDa	Human, Mouse, Rat	WB IHC IF/ICC	200ug	59670
CLSAF0880	Histone H2B Antibody	14kDa	Human, Mouse,	IHC IF/ICC	200ug	59670
CLSAF0906	Phospho-CDC25A(Ser75) Antibody	59kDa	Human, Mouse, Rat	WB IHC	200ug	59670
CLSAF0908	Phospho-Akt(Ser473) Antibody	60kDa	Human, Mouse, Rat	WB IHC IF/ICC	200ug	59670
CLSAF0911	GAPDH Antibody	37kD	H, Mk	WB	200ug	59670
CLSAF0931	Cyclin D1 Antibody	33kDa	Human Mouse Rat	WB IHC IF/ICC	200ug	59670
CLSAF0932	Phospho-Cyclin D1 (Thr286) Antibody	33kDa	Human Mouse Rat	WB IHC IF/ICC	200ug	59670
CLSAF1009	HIF1A antibody	120kDa	Human, Mouse, Rat	WB IHC	200ug	59670
CLSAF1014	Phospho-ERK1/2 (Tyr204) Antibody	42,44kDa	Human, Mouse, Rat	WB IHC	200ug	59670
CLSAF1015	Phospho-ERK1/2 (Thr202/Tyr204) Antibody	42,44kDa	Human, Mouse, Rat	WB IHC	200ug	59670
CLSAF1017	Acetyl-NF-κappaB p65 (Lys310) Antibody	65 KD	Human, Mouse, Rat	WB IHC IF	200ug	59670
CLSAF1019	Acetyl-Histone H3 (Lys23) Antibody	15 KD	Human, Mouse, Rat	WB IF	200ug	59670
CLSAF1021	Acetyl-Histone H4 (Lys12) Antibody	11kDa	Human, Mouse, Rat	WB IHC IF	200ug	59670
CLSAF1023	Acetyl-Histone H3 (Lys18) Antibody	15 kDa	Human, Mouse, Rat	WB IHC IF	200ug	59670
CLSAF1024	Acetyl-p53 (Lys317) Antibody	53KD	Human, Mouse, Rat	WB IF	200ug	59670
CLSAF1027	TGF beta1 Antibody	45kd	Human, Mouse, Rat	WB IHC IF	200ug	59670
CLSAF1032	alpha-SMA antibody	45 KD	Human, Mouse, Rat	WB IHC IF	200ug	59670
CLSAF2002	Phospho-I kappaB- alpha (Ser32/Ser36) Antibody	39kDa	Human, Mouse, Rat	WB IHC IF/ICC	200ug	59670
CLSAF2004	Phospho-GR (Ser211) Antibody	95kDa	Human, Mouse, Rat	WB IHC	200ug	59670
CLSAF2006	Phospho-NF- kappaB p65 (Ser536) Antibody	65kDa	Human, Mouse, Rat	WB IHC IP	200ug	59670
CLSAF2008	Phospho-SYK (Tyr323) Antibody	80kDa	Human, Mouse, Rat	WB IHC IF/ICC	200ug	59670
CLSAF2012	Phospho-JAK1 (Tyr1022) Antibody	130kDa	Human, Mouse, Rat	WB IHC	200ug	59670
CLSAF2014	Phospho-Chk1 (Ser280) Antibody	56kDa	Human	WB	200ug	59670
CLSAF2016	Phospho-GSK3 beta (Ser9) Antibody	46kDa	Human, Mouse, Rat	WB IHC IP	200ug	59670

Antibodies
HSN : 38220090

Cat#	Product Description	MW	Reactivity	Application	Pack Size	Unit Price
CLSAF3001	Phospho-SGK (Ser422) Antibody	54kDa	Human, Mouse, Rat	WB IHC	200ug	59670
CLSAF3002	Phospho-I kappaB- epsilon (Ser22) Antibody	38kDa	Human, Mouse, Rat	WB IHC IF/ICC	200ug	59670
CLSAF3003	Phospho-HSP20 (Ser16) Antibody	kDa	Human, Mouse, Rat	IHC IF/ICC	200ug	59670
CLSAF3004	Phospho-Chk1 (Ser296) Antibody	45kDa	Human	WB IHC	200ug	59670
CLSAF3005	Phospho-Chk1 (Ser286) Antibody	55kDa	Human	WB IF/ICC	200ug	59670
CLSAF3006	Phospho-Chk1 (Ser301) Antibody	55kDa	Human, Mouse, Rat	WB IF/ICC	200ug	59670
CLSAF3007	Phospho-Chk1 (Ser317) Antibody	56kDa	Human, Mouse, Rat	WB	200ug	59670
CLSAF3008	Phospho-Chk1 (Ser345) Antibody	kDa	Human, Mouse, Rat	IHC	200ug	59670
CLSAF3009	Phospho-IKK- beta (Tyr188) Antibody	87kDa	Human, Mouse, Rat	WB IHC	200ug	59670
CLSAF3010	Phospho-IKK- beta (Tyr199) Antibody	85kDa	Human, Mouse, Rat	WB IHC	200ug	59670
CLSAF3011	Phospho-Aurora Kinase (Thr288) Antibody	48kDa	Human, Mouse, Rat	WB IHC	200ug	59670
CLSAF3012	Phospho-IKK- alpha (Thr23) Antibody	85kDa	Human, Mouse, Rat	WB IHC	200ug	59670
CLSAF3013	Phospho-IKK- alpha/ beta (Ser180/181) Antibody	85kDa	Human, Mouse, Rat	WB IHC	200ug	59670
CLSAF3014	Phospho-IKK- alpha (Ser176) /IKK- beta (Ser177) Antibody	85kDa	Human, Mouse, Rat	WB IHC	200ug	59670
CLSAF3015	Phospho-p73 (Tyr99) Antibody	80kDa	Human, Mouse	WB IHC	200ug	59670
CLSAF3016	Phospho-HDAC3 (Ser424) Antibody	48kDa	Human, Mouse, Rat	WB IHC IF/ICC	200ug	59670
CLSAF3017	Phospho-Survivin (Thr117) Antibody	16kDa	Human, Mouse, Rat	WB IHC IF/ICC	200ug	59670
CLSAF3018	Phospho-PDK1 (Ser241) Antibody	63kDa	Human, Mouse, Rat	WB IHC	200ug	59670
CLSAF3019	Phospho-MAP3K7 (Thr187) Antibody	60kDa	Human, Mouse, Rat	WB	200ug	59670
CLSAF3020	Phospho-FKHL1 (Ser253) Antibody	97kDa	Human, Mouse, Rat	WB IHC	200ug	59670
CLSAF3021	Phospho-p56 Dok-2 (Tyr299) Antibody	56kDa	Human, Mouse	WB	200ug	59670
CLSAF3022	Phospho-JAK2 (Tyr1007) Antibody	kDa	Human, Mouse, Rat	IHC	200ug	59670
CLSAF3023	Phospho-JAK2 (Tyr221) Antibody	125kDa	Human, Mouse, Rat	WB IHC	200ug	59670
CLSAF3024	Phospho-JAK2 (Tyr931) Antibody	125kDa	Human, Mouse, Rat	WB IHC	200ug	59670
CLSAF3025	Phospho-JAK2 (Tyr570) Antibody	125kDa	Human, Mouse, Rat	WB	200ug	59670
CLSAF3026	Phospho-p95/NBS1 (Ser343) Antibody	95kDa	Human, Rat	WB	200ug	59670
CLSAF3027	Phospho-MITF (Ser180/73) Antibody	52kDa	Human, Mouse	WB	200ug	59670
CLSAF3028	Phospho-ROCK2 (Tyr722) antibody	165kDa	Human, Mouse, Rat	WB	200ug	59670
CLSAF3029	Phospho-Dab1 (Tyr232) Antibody	60kDa	Human, Mouse, Rat	WB	200ug	59670
CLSAF3030	Phospho-MSK1 (Ser376) Antibody	90kDa	Human, Mouse	WB	200ug	59670
CLSAF3031	Phospho-MSK1 (Ser212) Antibody	90kDa	Human, Mouse	WB IHC	200ug	59670
CLSAF3032	Phospho-SNAI1 (Ser246) Antibody	29kDa	Human, Mouse	WB IF/ICC	200ug	59670
CLSAF3033	Phospho-Chk2 (Thr387) Antibody	62kDa	Human, Mouse, Rat	WB IHC	200ug	59670
CLSAF3034	Phospho-Chk2 (Thr383) Antibody	60kDa	Human, Mouse, Rat	WB IF/ICC	200ug	59670
CLSAF3035	Phospho-Chk2 (Ser516) Antibody	62kDa	Human	WB	200ug	59670
CLSAF3036	Phospho-Chk2 (Thr68) Antibody	62kDa	Human, Mouse, Rat	WB IHC	200ug	59670
CLSAF3037	Phospho-c-Abl (Tyr245) Antibody	135kDa	Human, Mouse, Rat	WB IF/ICC	200ug	59670
CLSAF3038	Phospho-Abl (Tyr204) Antibody	135kDa	Human, Mouse, Rat	WB	200ug	59670
CLSAF3039	Phospho-Abl (Tyr393/412) Antibody	135kDa	Human, Mouse	WB IHC IF/ICC	200ug	59670
CLSAF3040	Phospho-Abl (Tyr412) Antibody	135kDa	Human, Mouse	WB IHC	200ug	59670
CLSAF3041	Phospho-EGFR (Thr678) Antibody	175kDa	Human, Mouse, Rat	WB IF/ICC	200ug	59670
CLSAF3042	Phospho-EGFR (Thr693) Antibody	175kDa	Human, Mouse, Rat	WB IHC IF/ICC	200ug	59670
CLSAF3043	Phospho-EGFR (Tyr1016) Antibody	175kDa	Human, Mouse, Rat	WB IHC IF/ICC	200ug	59670
CLSAF3044	Phospho-EGFR (Ser1070) Antibody	176kDa	Human, Mouse, Rat	WB IHC	200ug	59670
CLSAF3045	Phospho-EGFR (Tyr1092) Antibody	175kDa	Human, Mouse, Rat	WB IHC	200ug	59670
CLSAF3046	Phospho-EGFR (Tyr1110) Antibody	175kDa	Human, Mouse, Rat	WB	200ug	59670
CLSAF3047	Phospho-EGFR (Tyr1172) Antibody	175kDa	Human, Mouse, Rat	WB	200ug	59670
CLSAF3048	Phospho-EGFR (Tyr1197) Antibody	175kDa	Human, Mouse, Rat	WB IHC	200ug	59670
CLSAF3049	Phospho-EGFR (Tyr869) Antibody	175kDa	Human, Mouse, Rat	WB	200ug	59670
CLSAF3050	Phospho-EGFR (Ser695) Antibody	135kDa	Human, Mouse, Rat	WB	200ug	59670
CLSAF3051	Phospho-EGFR (Ser1026) Antibody	160kDa	Human, Mouse, Rat	WB	200ug	59670
CLSAF3052	Phospho-EGFR (Ser1071) Antibody	150-160kDa	Human, Mouse, Rat	WB	200ug	59670
CLSAF3053	Phospho-Fos (Ser362) Antibody	40kDa	Human, Mouse, Rat	WB IHC	200ug	59670
CLSAF3054	Phospho-Myc (Ser62) Antibody	50kDa	Human, Mouse, Rat	WB IHC IF/ICC	200ug	59670
CLSAF3055	Phospho-Myc (Thr58) Antibody	57kDa	Human, Mouse, Rat	WB IHC IP	200ug	59670
CLSAF3056	Phospho-Lamin A/C (Ser392) Antibody	74,65kDa	Human, Mouse, Rat	WB IHC IF/ICC	200ug	59670
CLSAF3057	Phospho-Estrogen Receptor- alpha (Ser167) Antibody	66kDa	Human:S167	WB IHC	200ug	59670
CLSAF3058	Phospho-Estrogen Receptor- alpha (Tyr537) Antibody	66kDa	Human, Mouse, Rat	WB IHC	200ug	59670
CLSAF3059	Phospho-Estrogen Receptor- alpha (Ser104) Antibody	66kDa	Human, Mouse, Rat	WB IHC	200ug	59670
CLSAF3060	Phospho-Estrogen Receptor- alpha (Ser106) Antibody	66kDa	Human, Mouse, Rat	WB IHC	200ug	59670
CLSAF3061	Phospho-Estrogen Receptor- alpha (Ser118) Antibody	66kDa	Human, Mouse	WB IHC	200ug	59670
CLSAF3062	Phospho-C-RAF (Ser621) Antibody	74kDa	Human, Mouse, Rat	WB IHC IF/ICC	200ug	59670
CLSAF3063	Phospho-C-RAF (Ser296) Antibody	74kDa	Human, Mouse, Rat	WB IHC	200ug	59670
CLSAF3064	Phospho-C-RAF (Ser259) Antibody	74kDa	Human, Mouse, Rat	WB IHC	200ug	59670



Antibodies

HSN : 38220090

Cat#	Product Description	MW	Reactivity	Application	Pack Size	Unit Price
CLSAF3065	Phospho-C-RAF (Ser338) Antibody	74kDa	Human, Mouse, Rat	WB	200ug	59670
CLSAF3066	Phospho-GR (Ser226) Antibody	86kDa	Human, Mouse, Rat	WB IHC	200ug	59670
CLSAF3067	Phospho-GR (Ser203) Antibody	86kDa	Human, Mouse	WB	200ug	59670
CLSAF3068	Phospho-TK (Ser13) Antibody	25kDa	Human, Mouse, Rat	WB IHC	200ug	59670
CLSAF3069	Phospho-HER2 (Tyr1248) Antibody	185kDa	Human, Mouse, Rat	WB IHC	200ug	59670
CLSAF3070	Phospho-HER2 (Tyr877) Antibody	185kDa	Human, Mouse, Rat	WB IHC IP	200ug	59670
CLSAF3071	Phospho-HER2 (Tyr1112) Antibody	150kDa	Human, Mouse, Rat	WB	200ug	59670
CLSAF3072	Phospho-Trk A (Tyr680+Tyr681) Antibody	87kDa	Human, Mouse, Rat	WB	200ug	59670
CLSAF3073	Phospho-p53 (Ser20) Antibody	53kDa	Human, Mouse, Rat	WB	200ug	59670
CLSAF3074	Phospho-p53 (Ser392) Antibody	53kDa	Human	WB IHC IF/ICC	200ug	59670
CLSAF3075	Phospho-p53 (Ser15) Antibody	53kDa	Human, Rat	WB IHC IP	200ug	59670
CLSAF3076	Phospho-p53 (Ser46) Antibody	53kDa	Human	WB	200ug	59670
CLSAF3077	Phospho-p53 (Ser9) Antibody	53kDa	Human	WB IHC	200ug	59670
CLSAF3078	Phospho-p53 (Ser366) Antibody	48kDa	Human	WB IHC	200ug	59670
CLSAF3079	Phospho-p53 (Ser315) Antibody	53kDa	Human	WB IHC IP	200ug	59670
CLSAF3080	Phospho-HSP27 (Ser15) Antibody	27kDa	Human, Mouse, Rat	WB IHC	200ug	59670
CLSAF3081	Phospho-HSP27 (Ser78) Antibody	27kDa	Human	WB	200ug	59670
CLSAF3082	Phospho-HSP27 (Ser82) Antibody	27kDa	Human, Mouse, Rat	WB	200ug	59670
CLSAF3083	Phospho-ATPase (Ser16) Antibody	112kDa	Human, Mouse, Rat	WB IHC	200ug	59670
CLSAF3084	Phospho-Amyloid beta A4 (Thr743/668) Antibody	140kDa	Human, Mouse, Rat	WB IHC IF/ICC	200ug	59670
CLSAF3085	Phospho-Integrin beta3 (Tyr773) Antibody	130kDa	Human, Mouse, Rat	WB IHC	200ug	59670
CLSAF3086	Phospho-Integrin beta3 (Tyr785) Antibody	110kDa	Human, Mouse, Rat	WB	200ug	59670
CLSAF3087	Phospho-eIF2 alpha (Ser51) Antibody	38kDa	Human, Mouse, Rat	WB	200ug	59670
CLSAF3088	Phospho-ICAM-1 (Tyr512) Antibody	92kDa	Human	WB	200ug	59670
CLSAF3089	Phospho-c-Jun (Ser63) Antibody	48kDa	Human, Mouse, Rat	WB IHC	200ug	59670
CLSAF3090	Phospho-c-Jun (Ser243) Antibody	48kDa	Human, Mouse, Rat	WB IHC IP	200ug	59670
CLSAF3091	Phospho-c-Jun (Thr239) Antibody	48kDa	Human, Mouse, Rat	WB IHC IP	200ug	59670
CLSAF3092	Phospho-c-Jun (Thr91) Antibody	48kDa	Human, Mouse, Rat	WB IHC	200ug	59670
CLSAF3093	Phospho-c-Jun (Thr93) Antibody	48kDa	Human, Mouse, Rat	WB IHC IP	200ug	59670
CLSAF3094	Phospho-c-Jun (Tyr170) Antibody	48kDa	Human, Mouse, Rat	WB	200ug	59670
CLSAF3095	Phospho-c-Jun (Ser73) Antibody	48kDa	Human, Mouse, Rat	WB IHC	200ug	59670
CLSAF3096	Phospho-PKCB (Ser661) Antibody	77kDa	Human, Mouse, Rat	WB	200ug	59670
CLSAF3097	Phospho-Keratin 8 (Ser432) Antibody	53kDa	Human, Mouse, Rat	WB IHC IF/ICC	200ug	59670
CLSAF3098	Phospho-IR (Tyr1355) Antibody	95kDa	Human:Y1355	WB IHC	200ug	59670
CLSAF3099	Phospho-IR (Tyr1361) Antibody	95kDa	Human, Mouse, Rat	WB IHC	200ug	59670
CLSAF3100	Phospho-Lck (Tyr505) Antibody	56kDa	Human, Mouse, Rat	WB IHC	200ug	59670
CLSAF3101	Phospho-Lck (Tyr393) Antibody	56kDa	Human, Mouse, Rat	WB IF/ICC	200ug	59670
CLSAF3102	Phospho-Fyn (Tyr530) Antibody	59kDa	Human, Mouse, Rat	WB IHC	200ug	59670
CLSAF3103	Phospho-Retinoblastoma (Ser780) Antibody	106kDa	Human, Mouse, Rat	WB IHC	200ug	59670
CLSAF3104	Phospho-Retinoblastoma (Ser795) Antibody	106kDa	Human, Mouse, Rat	WB IHC	200ug	59670
CLSAF3105	Phospho-Retinoblastoma (Ser807) Antibody	106kDa	Human, Mouse, Rat	WB IHC	200ug	59670
CLSAF3106	Phospho-Progesterone Receptor (Ser294) Antibody	99kDa	Human, Mouse, Rat	WB IF/ICC	200ug	59670
CLSAF3107	Phospho-Progesterone Receptor (Ser400) Antibody	99kDa	Human	WB IF/ICC	200ug	59670
CLSAF3108	Phospho-CDC2 (Tyr15) Antibody	34kDa	Human, Mouse, Rat	WB	200ug	59670
CLSAF3109	Phospho-ATP1 alpha1/Na+K+ ATPase1 (Ser23) Antibody	113kDa	Human, Mouse, Rat	WB IF/ICC	200ug	59670
CLSAF3110	Phospho-eIF4E (Ser209) Antibody	25kDa	Human, Mouse, Rat	WB IHC	200ug	59670
CLSAF3111	Phospho-NPM (Thr199) Antibody	32 38kDa	Human, Mouse, Rat	WB IHC IF/ICC	200ug	59670
CLSAF3112	Phospho-Tyrosine Hydroxylase (Ser19) Antibody	45kDa	Human, Mouse, Rat	WB IHC IF/ICC	200ug	59670
CLSAF3113	Phospho-Tyrosine Hydroxylase (Ser31) Antibody	60kDa	Human, Mouse, Rat	WB IHC	200ug	59670
CLSAF3114	Phospho-Tyrosine Hydroxylase (Ser40) Antibody	55kDa	Human, Mouse, Rat	WB IHC	200ug	59670
CLSAF3115	Phospho-Tyrosine Hydroxylase (Ser19) Antibody	45kDa	Human, Mouse, Rat	WB IHC IF/ICC	200ug	59670
CLSAF3116	Phospho-M-CSF Receptor (Tyr809) Antibody	108kDa	Human, Mouse, Rat	WB	200ug	59670
CLSAF3117	Phospho-Adrenergic Receptor beta2 (Ser346) Antibody	40kDa	Human:S346	WB IHC IF/ICC	200ug	59670
CLSAF3118	Phospho-hnRNP C1/2 (Ser260) Antibody	41kDa	Human, Mouse, Rat	WB IHC	200ug	59670
CLSAF3119	Phospho-Lyn (Tyr507) Antibody	53,56kDa	Human, Mouse, Rat	WB IHC	200ug	59670
CLSAF3120	Phospho-Ret (Tyr1062) Antibody	175kDa	Human, Mouse, Rat	WB	200ug	59670
CLSAF3121	Phospho-SP1 (Thr453) Antibody	90kDa	Human, Mouse, Rat	WB IHC IF/ICC	200ug	59670
CLSAF3122	Phospho-SP1 (Thr739) Antibody	81kDa	Human, Mouse, Rat	WB	200ug	59670
CLSAF3123	Phospho-IGF1R (Tyr1165/Tyr1166) Antibody	90,155kDa	Human, Mouse, Rat	WB	200ug	59670
CLSAF3124	Phospho-IGF1R (Tyr1346) Antibody	kDa	Human, Mouse, Rat	IHC	200ug	59670
CLSAF3125	Phospho-IGF1R (Tyr1161) Antibody	90,155kDa	Human, Mouse, Rat	WB IHC IP	200ug	59670



Antibodies

HSN : 38220090

Cat#	Product Description	MW	Reactivity	Application	Pack Size	Unit Price
CLSAF3126	Phospho-HSP90B (Ser254) Antibody	90 83kDa	Human, Mouse, Rat	WB IHC IF/ICC	200ug	59670
CLSAF3127	Phospho-CD45 (Ser1007) Antibody	150kDa	Human, Mouse, Rat	WB IF/ICC	200ug	59670
CLSAF3128	Phospho-c-Met (Tyr1003) Antibody	155kDa	Human, Mouse, Rat	WB IHC IF/ICC	200ug	59670
CLSAF3129	Phospho-Met (Tyr1234) Antibody	145kDa	Human, Mouse, Rat	WB	200ug	59670
CLSAF3130	Phospho-Met (Tyr1349) Antibody	145kDa	Human, Mouse, Rat	WB	200ug	59670
CLSAF3131	Phospho-Vimentin (Ser56) Antibody	54kDa	Human	WB IHC	200ug	59670
CLSAF3132	Phospho-PDGFR beta (Tyr740) Antibody	170kDa	Human, Mouse, Rat	WB IHC	200ug	59670
CLSAF3133	Phospho-PDGFR beta (Tyr1021) Antibody	kDa	Human, Mouse, Rat	IHC	200ug	59670
CLSAF3134	Phospho-PDGFRb (Tyr771) Antibody	0kDa	Human, Rat	WB	200ug	59670
CLSAF3135	Phospho-Histone H2A (Thr121) Antibody	kDa	Human, Mouse, Rat	IHC	200ug	59670
CLSAF3136	Phospho-Myb (Ser532) Antibody	kDa	Human, Mouse	IHC	200ug	59670
CLSAF3137	Phospho-Androgen Receptor (Ser650) Antibody	kDa	Human	IHC	200ug	59670
CLSAF3138	Phospho-BCL-2 (Ser87) Antibody	28kDa	Human, Mouse, Rat	WB IHC	200ug	59670
CLSAF3139	Phospho-BCL-2 (Thr69) Antibody	kDa	Human	IHC IF/ICC	200ug	59670
CLSAF3140	Phospho-BCL-2 (Ser70) Antibody	28kDa	Human	WB IHC IP	200ug	59670
CLSAF3141	Phospho-Tau (Ser214) Antibody	78kDa	Human, Mouse, Rat	WB	200ug	59670
CLSAF3142	Phospho-Tau (Ser235) Antibody	78kDa	Human, Mouse, Rat	WB	200ug	59670
CLSAF3143	Phospho-Tau (Ser356) Antibody	78kDa	Human, Mouse, Rat	WB IHC	200ug	59670
CLSAF3144	Phospho-Tau (Ser404) Antibody	78kDa	Human, Mouse, Rat	WB	200ug	59670
CLSAF3145	Phospho-Tau (Ser422) Antibody	80kDa	Human, Mouse, Rat	WB IHC	200ug	59670
CLSAF3146	Phospho-Tau (Thr212) Antibody	kDa	Human, Mouse, Rat	IHC	200ug	59670
CLSAF3147	Phospho-Tau (Thr231) Antibody	78kDa	Human, Mouse, Rat	WB	200ug	59670
CLSAF3148	Phospho-Tau (Ser396) Antibody	78kDa	Human, Mouse, Rat	WB	200ug	59670
CLSAF3149	Phospho-Tau (Thr181) Antibody	0kDa	Human	WB	200ug	59670
CLSAF3150	Phospho-Tau (Thr205) Antibody	78kDa	Human, Mouse, Rat	WB	200ug	59670
CLSAF3151	Phospho-Tau (Ser262) Antibody	0kDa	Human, Mouse, Rat	WB	200ug	59670
CLSAF3152	Phospho-KIT (Tyr703) Antibody	145kDa	Human, Mouse	WB IHC	200ug	59670
CLSAF3153	Phospho-c-Kit (Tyr721) Antibody	120,145kDa	Human, Mouse, Rat	WB	200ug	59670
CLSAF3154	Phospho-Bcr (Tyr177) Antibody	160kDa	Human, Mouse	WB	200ug	59670
CLSAF3155	Phospho-Bcr (Tyr360) Antibody	142kDa	Human, Mouse	WB IHC IF/ICC	200ug	59670
CLSAF3156	Phospho-FGFR1 (Tyr766) Antibody	140kDa	Human, Mouse, Rat	WB IHC	200ug	59670
CLSAF3157	Phospho-FGFR1 (Tyr654) Antibody	120kDa	Human, Mouse, Rat	WB IF/ICC	200ug	59670
CLSAF3158	Phospho-FGFR1 (Tyr154) Antibody	120,145kDa	Human, Mouse, Rat	WB	200ug	59670
CLSAF3159	Phospho-Vitamin D Receptor (Ser208) Antibody	55kDa	Human	WB IF/ICC	200ug	59670
CLSAF3160	Phospho-SRF (Ser99) Antibody	51kDa	Human, Mouse, Rat	WB IHC	200ug	59670
CLSAF3161	Phospho-Src (Tyr529) Antibody	60kDa	Human, Mouse, Rat	WB IHC	200ug	59670
CLSAF3162	Phospho-Src (Tyr418) Antibody	60kDa	Human, Mouse, Rat	WB IHC	200ug	59670
CLSAF3163	Phospho-Src (Ser75) Antibody	60kDa	Human, Mouse, Rat	WB IHC	200ug	59670
CLSAF3165	Phospho-Glycogen Synthase (Ser645) Antibody	83,89kDa	Human, Mouse, Rat	WB IHC	200ug	59670
CLSAF3166	Phospho-GFAP (Ser38) Antibody	50kDa	Human, Mouse	WB IHC IF/ICC	200ug	59670
CLSAF3167	Phospho-p47 plox (Ser359) Antibody	45kDa	Human	WB IHC IF/ICC	200ug	59670
CLSAF3168	Phospho-Cyclin B1 (Ser126) Antibody	60kDa	Human, Mouse, Rat	WB IHC	200ug	59670
CLSAF3169	Phospho-Cyclin B1 (Ser147) Antibody	60kDa	Human, Mouse, Rat	WB IHC	200ug	59670
CLSAF3170	Phospho-B-RAF (Thr599) Antibody	kDa	Human, Mouse, Rat	IHC	200ug	59670
CLSAF3171	Phospho-B-RAF (Ser446) Antibody	110kDa	Human, Mouse	WB IHC	200ug	59670
CLSAF3172	Phospho-Ezrin (Thr566) Antibody	69kDa	Human, Mouse, Rat	WB	200ug	59670
CLSAF3173	Phospho-Ezrin (Tyr353) Antibody	69kDa	Human, Mouse, Rat	WB	200ug	59670
CLSAF3174	Phospho-Ezrin (Tyr478) Antibody	70kDa	Human, Mouse, Rat	WB	200ug	59670
CLSAF3175	Phospho-Ezrin (Tyr146) Antibody	69kDa	Human, Mouse, Rat	WB	200ug	59670
CLSAF3176	Phospho-ATF2 (Ser62 or 44) Antibody	52kDa	Human, Mouse, Rat	WB IHC IP	200ug	59670
CLSAF3177	Phospho-ATF2 (Ser112 or 94) Antibody	52kDa	Human, Mouse, Rat	WB IHC IP	200ug	59670
CLSAF3178	Phospho-ATF2 (Thr69 or 51) Antibody	52kDa	Human, Mouse, Rat	WB IHC IP	200ug	59670
CLSAF3179	Phospho-ATF2 (Thr71 or 53) Antibody	52kDa	Human, Mouse, Rat	WB IHC IP	200ug	59670
CLSAF3180	Phospho-ATF2 (Thr73 or 55) Antibody	52kDa	Human, Mouse, Rat	WB IHC IP	200ug	59670
CLSAF3181	Phospho-CD19 (Tyr531) Antibody	61kDa	Human, Mouse	WB	200ug	59670
CLSAF3182	Phospho-VAV1 (Tyr174) Antibody	95kDa	Human, Mouse, Rat	WB IHC	200ug	59670
CLSAF3183	Phospho-RFA2 (Thr21) Antibody	35kDa	Human, Mouse	WB IHC	200ug	59670
CLSAF3184	Phospho-GATA1 (Ser142) Antibody	43kDa	Human, Mouse, Rat	WB IHC IP	200ug	59670
CLSAF3185	Phospho-GATA1 (Ser310) Antibody	43kDa	Human, Mouse, Rat	WB	200ug	59670
CLSAF3186	Phospho-CD44 (Ser706) Antibody	90 81kDa	Human, Mouse, Rat	WB	200ug	59670
CLSAF3187	Phospho-Histone H2A.X (Ser139) Antibody	15kDa	Human, Mouse, Rat	WB	200ug	59670
CLSAF3188	Phospho-CREB (Ser142) Antibody	43kDa	Human, Mouse, Rat	WB IHC IF/ICC	200ug	59670
CLSAF3189	Phospho-CREB (Ser133) Antibody	43kDa	Human, Mouse, Rat	WB IHC IP	200ug	59670
CLSAF3190	Phospho-PDGFRa (Tyr849) Antibody	140kDa	Human, Mouse, Rat	WB	200ug	59670
CLSAF3191	Phospho-PECAM-1 (Tyr713) Antibody	82 150kDa	Human, Mouse	WB IF/ICC	200ug	59670

Antibodies
HSN : 38220090

Cat#	Product Description	MW	Reactivity	Application	Pack Size	Unit Price
CLSAF3192	Phospho-PLCG2 (Tyr753) Antibody	150kDa	Human, Mouse, Rat	WB IHC	200ug	59670
CLSAF3193	Phospho-Stathmin 1 (Ser15) Antibody	19kDa	Human, Mouse, Rat	WB IHC IF/ICC	200ug	59670
CLSAF3194	Phospho-Stathmin 1 (Ser24) Antibody	19kDa	Human, Mouse, Rat	WB IHC	200ug	59670
CLSAF3195	Phospho-Stathmin 1 (Ser37) Antibody	19kDa	Human, Mouse, Rat	WB IHC	200ug	59670
CLSAF3196	Phospho-PKC alpha (Thr638) Antibody	80kDa	Human, Mouse, Rat	WB IHC	200ug	59670
CLSAF3197	Phospho-PKC-pan (Thr497) Antibody	80kDa	Human, Mouse, Rat	WB IHC IF/ICC	200ug	59670
CLSAF3198	Phospho-JunB (Ser259) Antibody	38kDa	Human, Mouse, Rat	WB IHC IP	200ug	59670
CLSAF3199	Phospho-Connexin 43 (Ser367) Antibody	43kDa	Human, Mouse, Rat	WB IHC	200ug	59670
CLSAF3200	Phospho-JunD (Ser255) Antibody	38kDa	Human, Mouse, Rat	WB IHC IP	200ug	59670
CLSAF3201	Phospho-Synapsin (Ser9) Antibody	77kDa	Human, Mouse, Rat	WB	200ug	59670
CLSAF3202	Phospho-C/EBP- beta (Thr235/188) Antibody	36kDa	Human, Mouse, Rat	WB IHC IF/ICC	200ug	59670
CLSAF3203	Phospho-IGFBP-3 (Ser183) Antibody	30 kDa	Human, Mouse	WB IHC	200ug	59670
CLSAF3204	Phospho-VEGFR1 (Tyr1213) Antibody	kDa	Human, Mouse, Rat	WB 1:500-1:2000	200ug	59670
CLSAF3205	Phospho-PTP1B (Ser50) Antibody	49kDa	Human, Mouse, Rat	WB IHC	200ug	59670
CLSAF3206	Phospho-Vinculin (Tyr821) Antibody	123kDa	Human, Mouse, Rat	WB IHC IF/ICC	200ug	59670
CLSAF3207	Phospho-GABA-RB (Ser434) Antibody	55kDa	Human, Mouse, Rat	WB IHC	200ug	59670
CLSAF3208	Phospho-ATF1 (Ser63) Antibody	29kDa	Human, Mouse	WB	200ug	59670
CLSAF3209	Phospho-PLCG1 (Tyr771) Antibody	155kDa	Human, Mouse, Rat	WB IHC	200ug	59670
CLSAF3210	Phospho-PLCG1 (Tyr783) Antibody	155kDa	Human, Mouse, Rat	WB IHC	200ug	59670
CLSAF3211	Phospho-Epo-R (Tyr368) Antibody	55kDa	Human, Mouse, Rat	WB IF/ICC	200ug	59670
CLSAF3212	Phospho-Elk1 (Ser383) Antibody	62kDa	Human, Mouse, Rat	WB IHC IP	200ug	59670
CLSAF3213	Phospho-Elk1 (Ser389) Antibody	62kDa	Human, Mouse, Rat	WB IHC IP	200ug	59670
CLSAF3214	Phospho-TNNI3 (Thr142) Antibody	28kDa	Human, Mouse, Rat	WB	200ug	59670
CLSAF3215	Phospho-TNNI3 (Ser43) Antibody	26kDa	Human, Mouse, Rat	WB IHC	200ug	59670
CLSAF3216	Phospho-PKR (Thr446) Antibody	74kDa	Human	WB	200ug	59670
CLSAF3217	Phospho-NF- kappaB p105/p50 (Ser927) Antibody	110kDa	Human, Mouse	WB IHC IF/ICC	200ug	59670
CLSAF3218	Phospho-NF- kappaB p105/p50 (Ser932) Antibody	105kDa	Human, Mouse, Rat	WB	200ug	59670
CLSAF3219	Phospho-NF- kappaB p105/p50 (Ser337) Antibody	105.50kDa	Human, Mouse, Rat	WB IHC	200ug	59670
CLSAF3220	Phospho-NF- kappaB p105/p50 (Ser893) Antibody	105kDa	Human	WB IHC	200ug	59670
CLSAF3221	Phospho-NF- kappaB p105/p50 (Ser907) Antibody	105kDa	Human	WB IHC IP	200ug	59670
CLSAF3222	Phospho-Filamin A (Ser2152) Antibody	280kDa	Human, Mouse, Rat	WB IHC	200ug	59670
CLSAF3223	Phospho-Synaptotagmin (Ser309) Antibody	47kDa	Human, Mouse, Rat	WB IHC	200ug	59670
CLSAF3224	Phospho-Synaptotagmin (Thr202) Antibody	60kDa	Human, Mouse, Rat	WB IHC	200ug	59670
CLSAF3225	Phospho-CBL (Tyr674) Antibody	120kDa	Human, Mouse, Rat	WB IHC	200ug	59670
CLSAF3226	Phospho-p70 S6 Kinase (Thr229) Antibody	70kDa	Human, Mouse, Rat	WB IHC	200ug	59670
CLSAF3227	Phospho-p70 S6 Kinase (Ser371) Antibody	70kDa	Human, Mouse, Rat	WB IHC	200ug	59670
CLSAF3228	Phospho-p70 S6 Kinase (Thr389/412) Antibody	70kDa	Human, Mouse, Rat	WB IHC IF/ICC	200ug	59670
CLSAF3229	Phospho-p70 S6 Kinase (Ser411) Antibody	70kDa	Human, Mouse, Rat	WB	200ug	59670
CLSAF3230	Phospho-p70 S6 Kinase (Ser424) Antibody	70kDa	Human, Mouse, Rat	WB IHC	200ug	59670
CLSAF3231	Phospho-p70 S6 Kinase (Thr421) Antibody	70kDa	Human, Mouse, Rat	WB IHC	200ug	59670
CLSAF3232	Phospho-Cofilin (Ser3) Antibody	19kDa	Human, Mouse, Rat	WB	200ug	59670
CLSAF3233	Phospho-GATA3 (Ser308) Antibody	47kDa	Human, Mouse	WB IF/ICC	200ug	59670
CLSAF3234	Phospho-Cyclin D1 (Ser90) Antibody	31kDa	Human, Mouse, Rat	WB 1:500-1:2000	200ug	59670
CLSAF3235	Phospho-Cyclin E1 (Thr395) Antibody	48kDa	Human	WB IHC	200ug	59670
CLSAF3236	Phospho-CDK1/CDC2 (Thr14) Antibody	34kDa	Human, Mouse, Rat	WB IF/ICC	200ug	59670
CLSAF3237	Phospho-CDK2 (Thr160) Antibody	34kDa	Human, Mouse, Rat	WB IHC	200ug	59670
CLSAF3238	Phospho-IL-8R beta/CDw128 beta (Ser347) Antibody	48kDa	Human, Mouse	WB IHC IF/ICC	200ug	59670
CLSAF3239	Phospho-I kappaB- alpha (Tyr305) Antibody	39kDa	Human, Mouse, Rat	WB IHC	200ug	59670
CLSAF3240	Phospho-ERK1/2 (Thr202) Antibody	44+42kDa	Human, Mouse, Rat	WB	200ug	59670
CLSAF3241	Phospho-PI3-kinase p85- alpha (Tyr607) Antibody	80kDa	Human, Mouse, Rat	WB IHC	200ug	59670
CLSAF3242	Phospho-PI3-kinase p85- alpha/ gamma (Tyr467/199) Antibody	54,83kDa	Human, Mouse, Rat	WB IF/ICC	200ug	59670
CLSAF3243	Phospho-MKP-1/2 (Ser296/318) Antibody	45kDa	Human, Mouse, Rat	WB IHC	200ug	59670
CLSAF3244	Phospho-SHP-1 (Tyr536) Antibody	67kDa	Human, Mouse, Rat	WB IHC	200ug	59670
CLSAF3245	Phospho-Shc (Tyr349) Antibody	70kDa	Human, Mouse, Rat	WB IHC	200ug	59670
CLSAF3246	Phospho-Shc (Tyr427) Antibody	70kDa	Human, Mouse, Rat	WB IHC	200ug	59670
CLSAF3247	Phospho-eNOS (Ser1177) Antibody	140kDa	Human, Mouse, Rat	WB IHC IF	200ug	59670
CLSAF3248	Phospho-eNOS (Thr494) Antibody	140kDa	Human, Mouse, Rat	WB	200ug	59670
CLSAF3249	Phospho-n-NOS (Ser852) Antibody	120 160kDa	Human, Mouse, Rat	WB IHC IF/ICC	200ug	59670
CLSAF3250	Phospho-MARCKS (Ser158) Antibody	kDa	Human, Mouse, Rat	WB	200ug	59670
CLSAF3251	Phospho-Cyclin D3 (Thr283) Antibody	31kDa	Human, Mouse, Rat	WB IHC	200ug	59670
CLSAF3252	Phospho-CDC25A (Ser75) Antibody	60kDa	Human, Mouse, Rat	WB	200ug	59670
CLSAF3253	Phospho-CDC25A (Ser178) Antibody	59kDa	Human, Mouse, Rat	WB IHC	200ug	59670



Antibodies

HSN : 38220090

Cat#	Product Description	MW	Reactivity	Application	Pack Size	Unit Price
CLSAF3254	Phospho-CDC25A (Ser124) Antibody	70kDa	Human, Mouse, Rat	WB	200ug	59670
CLSAF3255	Phospho-CDC25A (Thr507) Antibody	0kDa	Human, Mouse, Rat	WB	200ug	59670
CLSAF3256	Phospho-CDC25B (Ser323) Antibody	62kDa	Human, Mouse, Rat	WB	200ug	59670
CLSAF3257	Phospho-CDC25B (Ser353) Antibody	64kDa	Human	WB IHC	200ug	59670
CLSAF3258	Phospho-CDC25C (Ser216) Antibody	60kDa	Human	WB IHC	200ug	59670
CLSAF3259	Phospho-Akt1 (Thr450) Antibody	60kDa	Human, Mouse, Rat	WB IHC	200ug	59670
CLSAF3260	Phospho-Akt (Ser124) Antibody	60kDa	Human, Mouse, Rat	WB IHC	200ug	59670
CLSAF3261	Phospho-Akt (Ser129) Antibody	65kDa	Human, Mouse, Rat	WB	200ug	59670
CLSAF3262	Phospho-Akt (Thr308) Antibody	60kDa	Human, Mouse, Rat	WB IHC	200ug	59670
CLSAF3263	Phospho-Akt (Ser473) Antibody	56kDa	Human, Mouse, Rat	WB IHC	200ug	59670
CLSAF3264	Phospho-Akt2 (Ser474) Antibody	60kDa	Human, Mouse, Rat	WB IHC	200ug	59670
CLSAF3265	Phospho-VE-Cadherin (Tyr731) Antibody	130kDa	Human, Mouse	WB IHC	200ug	59670
CLSAF3266	Phospho-Catenin-β (Ser37) Antibody	92kDa	Human, Mouse, Rat	WB IHC	200ug	59670
CLSAF3267	Phospho-Catenin- beta (Ser33) Antibody	kDa	Human, Mouse, Rat	WB IHC	200ug	59670
CLSAF3268	Phospho-Catenin- beta (Thr41/Ser45) Antibody	92kDa	Human, Mouse, Rat	WB	200ug	59670
CLSAF3269	Phospho-Catenin- beta (Tyr489) Antibody	92kDa	Human, Mouse, Rat	WB IHC	200ug	59670
CLSAF3270	Phospho-INO5 (Tyr151) Antibody	kDa	Human, Mouse, Rat	IHC	200ug	59670
CLSAF3271	Phospho-Merlin (Ser518) Antibody	70kDa	Human, Mouse, Rat	WB	200ug	59670
CLSAF3272	Phospho-IRS-1 (Ser307) Antibody	180kDa	Human, Mouse, Rat	WB IHC IF/ICC	200ug	59670
CLSAF3273	Phospho-IRS-1 (Ser312) Antibody	180kDa	Human, Mouse, Rat	WB IF/ICC	200ug	59670
CLSAF3274	Phospho-IRS-1 (Ser636) Antibody	180kDa	Human, Mouse, Rat	WB IHC IF/ICC	200ug	59670
CLSAF3275	Phospho-IRS-1 (Ser639) Antibody	kDa	Human, Mouse, Rat	IHC	200ug	59670
CLSAF3276	Phospho-ADD1 (Ser726) Antibody	80kDa	Human, Mouse, Rat	WB IHC IF/ICC	200ug	59670
CLSAF3277	Phospho-CHOP (Ser30) Antibody	19kDa	Human, Mouse	WB IHC IF/ICC	200ug	59670
CLSAF3278	Phospho-AhR (Ser36) Antibody	90kDa	Human, Mouse, Rat	WB IHC	200ug	59670
CLSAF3279	Phospho-VEGFR2 (Tyr1059) Antibody	170kDa	Human, Mouse, Rat	WB	200ug	59670
CLSAF3280	Phospho-VEGFR2 (Tyr1214) Antibody	152kDa	Human, Mouse, Rat	WB IHC	200ug	59670
CLSAF3281	Phospho-VEGFR2 (Tyr951) Antibody	152kDa	Human, Mouse	WB IHC IF	200ug	59670
CLSAF3282	Phospho-MEK2 (Thr394) Antibody	44kDa	Human, Mouse, Rat	WB IHC IP	200ug	59670
CLSAF3283	Phospho-SREBP-1 (Ser439) Antibody	122kDa	Human, Rat	WB IHC	200ug	59670
CLSAF3284	Phospho-PPAR- gamma (Ser112) Antibody	57kDa	Human, Mouse, Rat	WB IHC IF	200ug	59670
CLSAF3285	Phospho-Synuclein (Ser129) Antibody	18kDa	Human, Mouse, Rat	WB IHC	200ug	59670
CLSAF3286	Phospho-Synuclein- alpha (Tyr133) Antibody	18kDa	Human, Mouse, Rat	WB	200ug	59670
CLSAF3287	Phospho-Synuclein- alpha (Tyr136) Antibody	18kDa	Human, Mouse, Rat	WB	200ug	59670
CLSAF3288	Phospho-BRCA1 (Ser1423) Antibody	kDa	Human, Rat	IHC	200ug	59670
CLSAF3289	Phospho-BRCA1 (Ser1524) Antibody	kDa	Human	IHC	200ug	59670
CLSAF3290	Phospho-p21 Cip1 (Thr145) Antibody	kDa	Human, Mouse, Rat	WB IHC	200ug	59670
CLSAF3293	Phospho-STAT3 (Tyr705) Antibody	86kDa	Human, Mouse, Rat	WB IHC IP	200ug	59670
CLSAF3294	Phospho-STAT3 (Ser727) Antibody	86kDa	Human, Mouse, Rat	WB IHC IP	200ug	59670
CLSAF3295	Phospho-STAT3 (Tyr705) Antibody	86kDa	Human, Mouse, Rat	WB IHC IP	200ug	59670
CLSAF3296	Phospho-Calcium Sensing Receptor (Thr888) Antibody	140kDa	Human, Mouse, Rat	WB IF/ICC	200ug	59670
CLSAF3297	Phospho-HNF4 alpha (Ser313) Antibody	52kDa	Human, Mouse, Rat	WB IHC IF/ICC	200ug	59670
CLSAF3298	Phospho-COT (Thr290) Antibody	60kDa	Human, Mouse, Rat	WB IHC IF/ICC	200ug	59670
CLSAF3299	Phospho-STAT1 (Ser727) Antibody	91kDa	Human, Mouse, Rat	WB IHC	200ug	59670
CLSAF3300	Phospho-STAT1 (Tyr701) Antibody	84kDa	Human, Mouse, Rat	WB IHC IP	200ug	59670
CLSAF3301	Phospho-STAT6 (Tyr641) Antibody	94kDa	Human, Mouse, Rat	WB IHC	200ug	59670
CLSAF3302	Phospho-STAT6 (Thr645) Antibody	94kDa	Human, Mouse, Rat	WB IHC IP	200ug	59670
CLSAF3303	Phospho-STAT5A (Ser780) Antibody	90kDa	Human, Mouse, Rat	WB IHC IP	200ug	59670
CLSAF3304	Phospho-STAT5A/B (Ser725/730) Antibody	90kDa	Human, Mouse, Rat	WB IHC IF/ICC	200ug	59670
CLSAF3305	Phospho-STAT5A (Tyr694) Antibody	90kDa	Human, Mouse, Rat	WB IHC	200ug	59670
CLSAF3306	Phospho-GluR1 (Ser863) Antibody	102kDa	Human, Mouse, Rat	WB IHC	200ug	59670
CLSAF3307	Phospho-GluR2 (Ser880) Antibody	99kDa	Human, Mouse, Rat	WB IHC	200ug	59670
CLSAF3308	Phospho-mTOR (Ser2448) Antibody	289kDa	Human, Mouse, Rat	WB IHC	200ug	59670
CLSAF3309	Phospho-mTOR (Ser2481) Antibody	288kDa	Human, Mouse, Rat	WB IHC IF/ICC	200ug	59670
CLSAF3310	Phospho-mTOR (Thr2446) Antibody	220kDa	Human, Mouse, Rat	WB	200ug	59670
CLSAF3311	Phospho-Caspase 3 (Ser150) Antibody	34kDa	Human, Mouse, Rat	WB IHC	200ug	59670
CLSAF3312	Phospho-ZAP-70 (Tyr319) Antibody	70kDa	Human, Mouse, Rat	WB	200ug	59670
CLSAF3313	Phospho-ZAP-70 (Tyr493) Antibody	70kDa	Human, Mouse, Rat	WB IHC	200ug	59670
CLSAF3314	Phospho-SYK (Tyr348) Antibody	72kDa	Human, Mouse, Rat	WB IHC	200ug	59670
CLSAF3315	Phospho-SYK (Tyr525) Antibody	72kDa	Human, Mouse, Rat	WB IHC	200ug	59670
CLSAF3316	Phospho-GATA4 (Ser262) Antibody	48kDa	Human, Mouse, Rat	WB IF/ICC	200ug	59670
CLSAF3317	Phospho-GATA4 (Ser105) Antibody	44kDa	Human, Mouse, Rat	WB IF/ICC	200ug	59670
CLSAF3318	Phospho-JNK1/2/3 (Thr183+Tyr185) Antibody	46,54kDa	Human, Mouse, Rat	WB	200ug	59670
CLSAF3319	Phospho-SAPK/JNK (Thr183) Antibody	46,54kDa	Human, Mouse, Rat	WB IHC	200ug	59670
CLSAF3320	Phospho-SAPK/JNK (Tyr185) Antibody	45kDa	Human, Mouse, Rat	WB IHC	200ug	59670
CLSAF3321	Phospho-SEK1/MKK4 (Ser80) Antibody	44kDa	Human, Mouse, Rat	WB IHC	200ug	59670

Antibodies
HSN : 38220090

Cat#	Product Description	MW	Reactivity	Application	Pack Size	Unit Price
CLSAF3322	Phospho-SEK1/MKK4 (Thr261) Antibody	44kDa	Human, Mouse, Rat	WB IHC	200ug	59670
CLSAF3323	Phospho-CrklI (Tyr221) Antibody	42kDa	Human, Mouse, Rat	WB IF/ICC	200ug	59670
CLSAF3324	Phospho-p27 Kip1 (Thr187) Antibody	27kDa	Human, Mouse, Rat	WB	200ug	59670
CLSAF3325	Phospho-p27 Kip1 (Thr198) Antibody	27kDa	Human	WB	200ug	59670
CLSAF3326	Phospho-p27 Kip1 (Ser10) Antibody	27kDa	Human, Mouse, Rat	WB	200ug	59670
CLSAF3327	Phospho-MKK3 (Ser189) Antibody	40kDa	Human, Mouse, Rat	WB IHC	200ug	59670
CLSAF3328	Phospho-YAP (Ser127) Antibody	65kDa	Human, Mouse, Rat	WB IHC	200ug	59670
CLSAF3329	Phospho-c-PLA2 (Ser505) Antibody	110kDa	Human, Mouse, Rat	WB IHC IF/ICC	200ug	59670
CLSAF3330	Phospho-SOX-9 (Ser181) Antibody	69kDa	Human, Mouse	WB IHC IF/ICC	200ug	59670
CLSAF3331	Phospho-Paxillin (Tyr118) Antibody	68kDa	Human, Mouse, Rat	WB	200ug	59670
CLSAF3332	Phospho-Paxillin (Tyr31) Antibody	68kDa	Human, Mouse, Rat	WB	200ug	59670
CLSAF3333	Phospho-C/EBP- alpha (Ser21) Antibody	45kDa	Human, Mouse, Rat	WB IHC	200ug	59670
CLSAF3334	Phospho-Tuberin/TSC2 (Thr1462) Antibody	kDa	Human, Mouse, Rat	IHC	200ug	59670
CLSAF3335	Phospho-GSK3 alpha/ beta (Tyr279/216) Antibody	51,46kDa	Human, Mouse, Rat	WB IHC	200ug	59670
CLSAF3336	Phospho-GSK3 alpha (Ser21) Antibody	51kDa	Human, Mouse, Rat	WB IHC IP	200ug	59670
CLSAF3337	Phospho-VASP (Ser157) Antibody	46kDa	Human, Mouse, Rat	WB IHC	200ug	59670
CLSAF3338	Phospho-VASP (Ser238) Antibody	46+50kDa	Human, Mouse, Rat	WB IHC	200ug	59670
CLSAF3339	Phospho-CCR5 (Ser336) Antibody	40kDa	Human, Mouse, Rat	WB	200ug	59670
CLSAF3340	Phospho-STAT5B (Ser731) Antibody	90kDa	Human, Mouse, Rat	WB IHC	200ug	59670
CLSAF3341	Phospho-ETK (Tyr566) Antibody	78kDa	Human, Mouse	WB IHC	200ug	59670
CLSAF3342	Phospho-STAT2 (Tyr690) Antibody	113kDa	Human, Rat	WB IHC	200ug	59670
CLSAF3343	Phospho-EFNB1/2 (Tyr330) Antibody	37kDa	Human, Mouse, Rat	WB	200ug	59670
CLSAF3344	Phospho-LIMK1/2 (Thr508/505) Antibody	72kDa	Human, Mouse, Rat	WB IHC	200ug	59670
CLSAF3345	Phospho-LIMK1 (Thr508) Antibody	70kDa	Human, Mouse, Rat	WB IHC	200ug	59670
CLSAF3346	Phospho-LIMK2 (Ser283) Antibody	72kDa	Human, Mouse, Rat	WB IHC	200ug	59670
CLSAF3347	Phospho-Ataxin 1 (Ser775) Antibody	87kDa	Human, Mouse	WB IF/ICC	200ug	59670
CLSAF3348	Phospho-Caspase 9 (Thr125) Antibody	47kDa	Human, Mouse, Rat	WB IHC	200ug	59670
CLSAF3349	Phospho-HDAC4 (Ser632) Antibody	119kDa	Human, Mouse, Rat	WB	200ug	59670
CLSAF3350	Phospho-p130 Cas (Tyr410) Antibody	130kDa	Human, Mouse, Rat	WB IHC	200ug	59670
CLSAF3351	Phospho-PTEN (Ser370) Antibody	54kDa	Human, Mouse, Rat	WB IHC	200ug	59670
CLSAF3352	Phospho-RhoA (Ser188) Antibody	22kDa	Human, Mouse, Rat	WB 1:500-1:2000	200ug	59670
CLSAF3353	Phospho-Calmodulin (Thr79+Ser81) Antibody	kDa	Human, Mouse, Rat	WB IHC IF/ICC	200ug	59670
CLSAF3354	Phospho-S6 Ribosomal Protein (Ser235) Antibody	32kDa	Human, Mouse, Rat	WB	200ug	59670
CLSAF3355	Acetyl-Histone H4 (Lys5) Antibody	11kDa	Human, Mouse, Rat	WB IHC IF/ICC	200ug	59670
CLSAF3356	Phospho-14-3-3 zeta (Ser58) Antibody	28kDa	Human, Mouse, Rat	WB IHC IF/ICC	200ug	59670
CLSAF3357	Phospho-14-3-3 zeta/ delta (Thr232) Antibody	28kDa	Human, Mouse, Rat	WB IHC	200ug	59670
CLSAF3358	Phospho-Histone H3.1 (Ser10) Antibody	17kDa	Human, Mouse, Rat	WB IHC	200ug	59670
CLSAF3359	Acetyl-Histone H3(Lys9) Antibody	17kDa	Human, Mouse, Rat	WB IHC IF/ICC	200ug	59670
CLSAF3360	Phospho-DNA-PK (Thr2647) Antibody	kDa	Human	IHC IF/ICC	200ug	59670
CLSAF3361	Phospho-ADAM 17 (Thr735) Antibody	93kDa	Human, Mouse, Rat	WB	200ug	59670
CLSAF3362	Phospho-Smad3 (Ser425) Antibody	58kDa	Human, Mouse, Rat	WB IHC	200ug	59670
CLSAF3363	Phospho-Smad3 (Thr179) Antibody	50kDa	Human, Mouse, Rat	WB IHC	200ug	59670
CLSAF3364	Phospho-Smad3 (Ser204) Antibody	48kDa	Human, Mouse, Rat	WB	200ug	59670
CLSAF3365	Phospho-Smad3 (Ser208) Antibody	40kDa	Human, Mouse, Rat	WB IHC	200ug	59670
CLSAF3366	Phospho-Smad3 (Ser213) Antibody	48kDa	Human, Mouse, Rat	WB	200ug	59670
CLSAF3367	Phospho-Smad2/3 (Thr8) Antibody	48/60kDa	Human, Mouse, Rat	WB	200ug	59670
CLSAF3368	Phospho-XIAP (Ser87) Antibody	57kDa	Human, Mouse, Rat	WB IHC	200ug	59670
CLSAF3369	Phospho-FOXO4 (Thr451) Antibody	65kDa	Human, Mouse:T452	WB	200ug	59670
CLSAF3370	Phospho-AFX (Ser197) Antibody	65kDa	Human, Mouse	WB IHC	200ug	59670
CLSAF3371	Phospho-CDK5 (Tyr15) Antibody	33kDa	Human, Mouse, Rat	WB	200ug	59670
CLSAF3372	Phospho-HSF1 (Ser303) Antibody	82kDa	Human, Mouse	WB IHC	200ug	59670
CLSAF3373	Phospho-NF- kappaB p100/p52 (Ser865) Antibody	100kDa	Human, Mouse, Rat	WB IHC IP	200ug	59670
CLSAF3374	Phospho-NF- kappaB p100/p52 (Ser869) Antibody	100kDa	Human, Mouse, Rat	WB IHC IP	200ug	59670
CLSAF3375	Phospho-NF-kB p100 (Ser872) Antibody	100kDa	Human, Mouse	WB	200ug	59670
CLSAF3376	Phospho-MDM2 (Ser166) Antibody	55+90kDa	Human, Mouse	WB IHC IF/ICC	200ug	59670
CLSAF3377	Phospho-E2F1 (Thr433) Antibody	47kDa	Human, Mouse	WB	200ug	59670
CLSAF3378	Phospho-AML1 (Ser276) Antibody	50kDa	Human, Mouse, Rat	WB	200ug	59670
CLSAF3379	Phospho-AML1 (Ser303) Antibody	50kDa	Human, Mouse, Rat	WB IHC	200ug	59670
CLSAF3380	Phospho-RelB (Ser552) Antibody	70kDa	Human, Mouse	WB IHC	200ug	59670
CLSAF3381	Phospho-MEF2A (Thr312) Antibody	55kDa	Human, Mouse, Rat	WB IHC IP	200ug	59670
CLSAF3382	Phospho-MEF2A (Thr319) Antibody	54kDa	Human, Mouse, Rat	WB IHC	200ug	59670
CLSAF3383	Phospho-MEK1 (Thr291) Antibody	45kDa	Human, Mouse, Rat	WB	200ug	59670
CLSAF3384	Phospho-MEK1/2 (Ser217) Antibody	45kDa	Human, Mouse, Rat	WB IHC	200ug	59670
CLSAF3385	Phospho-MEK1/2 (Ser221) Antibody	45kDa	Human, Mouse, Rat	WB IHC	200ug	59670
CLSAF3386	Phospho-Caveolin-1 (Tyr14) Antibody	23kDa	Human, Mouse, Rat	WB	200ug	59670

Antibodies
HSN : 38220090

Cat#	Product Description	MW	Reactivity	Application	Pack Size	Unit Price
CLSAF3387	Phospho-NF- kappaB p65 (Ser276) Antibody	75kDa	Human, Mouse, Rat	WB IHC IP	200ug	59670
CLSAF3388	Phospho-NF- kappaB p65 (Ser529) Antibody	75kDa	Human, Mouse	WB IHC	200ug	59670
CLSAF3389	Phospho-NF- kappaB p65 (Ser311) Antibody	75kDa	Human, Mouse	WB IHC	200ug	59670
CLSAF3390	Phospho-NF- kappaB p65 (Ser468) Antibody	75kDa	Human, Mouse, Rat	WB IHC IP	200ug	59670
CLSAF3391	Phospho-NF- kappaB p65 (Thr254) Antibody	75kDa	Human, Mouse, Rat	WB IHC IP	200ug	59670
CLSAF3392	Phospho-NF- kappaB p65 (Thr435) Antibody	75kDa	Human, Mouse, Rat	WB IHC IP	200ug	59670
CLSAF3393	Phospho-NF- kappaB p65 (Ser281) Antibody	kDa	Human, Mouse, Rat	WB IHC	200ug	59670
CLSAF3394	Phospho-PKC theta (Ser676) Antibody	80kDa	Human, Mouse, Rat	WB IHC	200ug	59670
CLSAF3395	Phospho-Rel (Ser503) Antibody	78kDa	Human	WB IHC	200ug	59670
CLSAF3396	Phospho-Dynamin-1 (Ser774) Antibody	97kDa	Human, Mouse, Rat	WB IHC	200ug	59670
CLSAF3397	Phospho-FAK (Tyr576) Antibody	125kDa	Human, Mouse, Rat	WB IHC	200ug	59670
CLSAF3398	Phospho-FAK (Tyr397) Antibody	119kDa	Human, Mouse, Rat	WB	200ug	59670
CLSAF3399	Phospho-FAK (Tyr861) Antibody	125kDa	Human, Mouse, Rat	WB	200ug	59670
CLSAF3400	Phospho-FAK (Tyr925) Antibody	125kDa	Human, Mouse, Rat	WB	200ug	59670
CLSAF3401	Phospho-FAK (Ser843) Antibody	120kDa	Human, Mouse, Rat	WB	200ug	59670
CLSAF3402	Phospho-HSL (Ser855/554) Antibody	81+83kDa	Human, Mouse, Rat	WB IHC	200ug	59670
CLSAF3403	Phospho-HSL (Ser552) Antibody	117kDa	Human, Mouse, Rat	WB IHC	200ug	59670
CLSAF3404	Phospho-PKC zeta (Thr410) Antibody	70kDa	Human, Mouse, Rat	WB IHC IF/ICC	200ug	59670
CLSAF3405	Phospho-PKC zeta (Thr560) Antibody	80kDa	Human, Mouse, Rat	WB IHC	200ug	59670
CLSAF3406	Phospho-NMDAR1 (Ser890) Antibody	105kDa	Human, Mouse, Rat	WB IHC IF/ICC	200ug	59670
CLSAF3407	Phospho-NMDAR1 (Ser897) Antibody	120kDa	Human, Mouse, Rat	WB IHC	200ug	59670
CLSAF3408	Phospho-PKC delta (Ser645) Antibody	78kDa	Human	WB IHC	200ug	59670
CLSAF3409	Phospho-PKC delta (Tyr313) Antibody	78kDa	Human, Mouse, Rat	WB IHC	200ug	59670
CLSAF3410	Phospho-PKCD (Tyr64) Antibody	78kDa	Human, Mouse, Rat	WB	200ug	59670
CLSAF3411	Phospho-Caldesmon (Ser789) Antibody	80kDa	Human, Mouse, Rat	WB IHC IF/ICC	200ug	59670
CLSAF3412	Phospho-SHP-2 (Tyr542) Antibody	70kDa	Human, Mouse, Rat	WB IHC	200ug	59670
CLSAF3413	Phospho-SHP-2 (Tyr580) Antibody	72kDa	Human, Mouse, Rat	WB IHC	200ug	59670
CLSAF3414	Phospho-BCL-XL (Thr47) Antibody	30kDa	Human, Mouse, Rat	WB IHC IF/ICC	200ug	59670
CLSAF3415	Phospho-BCL-XL (Ser62) Antibody	30kDa	Human, Mouse, Rat	WB IHC	200ug	59670
CLSAF3416	Phospho-FOXO1A (Ser329) Antibody	78kDa	Human, Mouse, Rat	WB IHC	200ug	59670
CLSAF3417	Phospho-FKHR (Ser256) Antibody	69kDa	Human, Mouse, Rat	WB IHC	200ug	59670
CLSAF3418	Phospho-FKHR (Ser319) Antibody	69kDa	Human, Mouse, Rat	WB IHC	200ug	59670
CLSAF3419	Phospho-FOXO1/3/4-pan (Thr24/32) Antibody	78kDa	Human, Mouse, Rat	WB IHC	200ug	59670
CLSAF3420	Phospho-NFAT4 (Ser165) Antibody	115kDa	Human, Mouse	WB IF/ICC	200ug	59670
CLSAF3421	Phospho-ACC1 (Ser80) Antibody	280kDa	Human, Mouse, Rat	WB IHC	200ug	59670
CLSAF3422	Phospho-AMPK (Ser485) Antibody	62kDa	Human, Mouse, Rat	WB IHC	200ug	59670
CLSAF3423	Phospho-AMPK alpha (Thr172) Antibody	62kDa	Human, Mouse, Rat	WB IHC	200ug	59670
CLSAF3424	Phospho-PAK1 (Thr212) Antibody	65kDa	Human, Mouse, Rat	WB IHC	200ug	59670
CLSAF3425	Phospho-NMDAR2B (Tyr1474) Antibody	165kDa	Human, Mouse, Rat	WB IHC	200ug	59670
CLSAF3426	Phospho-NMDAR2B (Tyr1336) Antibody	150kDa	Human, Mouse, Rat	WB IHC	200ug	59670
CLSAF3427	Phospho-G3BP-1 (Ser232) Antibody	60kDa	Human, Mouse	WB IHC	200ug	59670
CLSAF3428	Phospho-BIK (Thr33) Antibody	30kDa	Human	WB IHC	200ug	59670
CLSAF3429	Phospho-GAB1 (Tyr627) Antibody	110kDa	Human, Mouse	WB	200ug	59670
CLSAF3430	Phospho-Pin1 (Ser16) Antibody	18kDa	Human, Mouse, Rat	WB IHC	200ug	59670
CLSAF3431	Phospho-4E-BP1 (Thr36) Antibody	18kDa	Human, Mouse, Rat	WB IHC	200ug	59670
CLSAF3432	Phospho-4E-BP1 (Thr45) Antibody	18kDa	Human, Mouse, Rat	WB IHC	200ug	59670
CLSAF3433	Phospho-HDAC1 (Ser421) Antibody	62kDa	Human, Mouse, Rat	WB	200ug	59670
CLSAF3434	Phospho-CaMK2- beta/ gamma/ delta (Thr287) Antibody	50+65kDa	Human, Mouse, Rat	WB IHC	200ug	59670
CLSAF3435	Phospho-IL-10R alpha (Tyr496) Antibody	63kDa	Human	WB	200ug	59670
CLSAF3436	Phospho-Cortactin (Tyr421) Antibody	85kDa	Human, Mouse, Rat	WB	200ug	59670
CLSAF3437	Phospho-Cortactin (Tyr466) Antibody	85kDa	Human, Mouse, Rat	WB IHC	200ug	59670
CLSAF3438	Phospho-IRF-3 (Ser385) Antibody	57kDa	Human	WB IHC IF/ICC	200ug	59670
CLSAF3439	Phospho-SMC1 (Ser957) Antibody	145kDa	Human, Mouse	WB IHC	200ug	59670
CLSAF3440	Phospho-Kv2.1 (Ser805) Antibody	96kDa	Human, Mouse, Rat	WB	200ug	59670
CLSAF3441	Phospho-STAT4 (Tyr693) Antibody	86kDa	Human, Mouse, Rat	WB IHC IP	200ug	59670
CLSAF3442	Phospho-Caspase 8 (Ser347) Antibody	57kDa	Human, Rat	WB IHC	200ug	59670
CLSAF3443	Phospho-PKD1/PKC mu (Tyr463) Antibody	130kDa	Human, Mouse, Rat	WB IHC	200ug	59670
CLSAF3444	Phospho-PKD1/2/3/PKC mu (Ser738+Ser742) Antibody	101kDa	Human, Mouse, Rat	WB IHC	200ug	59670
CLSAF3445	Phospho-HER4 (Tyr1284) Antibody	180kDa	Human, Mouse, Rat	WB IHC IF/ICC	200ug	59670
CLSAF3446	Phospho-PPAR-BP (Thr1457) Antibody	168kDa	Human, Mouse	WB IHC IF/ICC	200ug	59670
CLSAF3447	Phospho-I kappaB- beta (Ser23) Antibody	37kDa	Human, Mouse, Rat	WB IHC IF/ICC	200ug	59670
CLSAF3448	Phospho-I kappaB- beta (Thr19) Antibody	37kDa	Human	WB	200ug	59670
CLSAF3449	Phospho-Smad2 (Ser467) Antibody	58kDa	Human, Mouse, Rat	WB IHC	200ug	59670
CLSAF3450	Phospho-Smad2 (Ser250) Antibody	65kDa	Human, Mouse, Rat	WB	200ug	59670
CLSAF3451	Phospho-Smad1 (Ser465) Antibody	60kDa	Human, Mouse, Rat	WB IHC	200ug	59670
CLSAF3452	Phospho-Smad1 (Ser187) Antibody	60 55kDa	Human, Mouse	WB IHC	200ug	59670
CLSAF3453	Phospho-LKB1 (Ser428) Antibody	65kDa	Human, Mouse	WB IHC IF/ICC	200ug	59670

Antibodies
HSN : 38220090

Cat#	Product Description	MW	Reactivity	Application	Pack Size	Unit Price
CLSAF3454	Phospho-LKB1 (Thr189) Antibody	65kDa	Human, Mouse	WB	200ug	59670
CLSAF3455	Phospho-p38 MAPK (Tyr182) Antibody	43kDa	Human, Mouse, Rat	WB IHC	200ug	59670
CLSAF3456	Phospho-p38 MAPK (Tyr322) Antibody	43kDa	Human, Mouse, Rat	WB IHC	200ug	59670
CLSAF3457	Phospho-p38 MAPK (Thr180) Antibody	43kDa	Human, Mouse, Rat	WB	200ug	59670
CLSAF3458	Phospho-CDC37 (Ser13) Antibody	44kDa	Human, Mouse, Rat	WB IHC	200ug	59670
CLSAF3459	Phospho-DRP-2 (Thr514) Antibody	65/70kDa	Human, Mouse, Rat	WB IHC IF/ICC	200ug	59670
CLSAF3460	Phospho-CaMK4 (Thr196/200) Antibody	60kDa	Human, Mouse, Rat	WB IHC IF/ICC	200ug	59670
CLSAF3461	Phospho-Trk B (Tyr705) Antibody	145kDa	Human, Mouse, Rat	WB IHC IF/ICC	200ug	59670
CLSAF3462	Phospho-Trk B (Tyr515) Antibody	145kDa	Human, Mouse, Rat	WB IHC	200ug	59670
CLSAF3463	Phospho-Syntaxin 1A (Ser14) Antibody	35kDa	Human, Mouse, Rat	WB IF/ICC	200ug	59670
CLSAF3464	Phospho-PDCD4 (Ser67) Antibody	56kDa	Human, Mouse, Rat	WB	200ug	59670
CLSAF3465	Phospho-PDCD4 (Ser457) Antibody	51kDa	Human, Mouse, Rat	WB IHC	200ug	59670
CLSAF3466	Phospho-FRS2 (Tyr436) Antibody	65kDa	Human, Mouse	WB IHC	200ug	59670
CLSAF3467	Phospho-BLNK (Tyr96) Antibody	50kDa	Human, Mouse	WB IHC	200ug	59670
CLSAF3468	Phospho-ATRIP (Ser68) Antibody	80kDa	Human, Mouse, Rat	WB	200ug	59670
CLSAF3469	Phospho-Estrogen Receptor- beta (Ser105) Antibody	59kDa	Human, Mouse, Rat	WB IF/ICC	200ug	59670
CLSAF3470	Phospho-HDAC2 (Ser394) Antibody	55kDa	Human, Mouse, Rat	WB	200ug	59670
CLSAF3471	Phospho-BAD (Ser155) Antibody	23kDa	Human, Mouse, Rat	WB IHC	200ug	59670
CLSAF3472	Phospho-BAD (Ser136) Antibody	23kDa	Human, Mouse, Rat	WB IHC	200ug	59670
CLSAF3473	Phospho-CPI17 alpha (Thr38) Antibody	22kDa	Human, Mouse, Rat	WB IHC	200ug	59670
CLSAF3474	Phospho-SirT1 (Ser47) Antibody	110kDa	Human, Mouse	WB	200ug	59670
CLSAF3475	Phospho-AurB (Thr232) Antibody	39kDa	Human, Mouse, Rat	WB IHC IF/ICC	200ug	59670
CLSAF3476	Phospho-ASK1 (Ser83) Antibody	155kDa	Human	WB IHC	200ug	59670
CLSAF3477	Phospho-ASK1 (Ser966) Antibody	155kDa	Human, Mouse, Rat	WB IHC	200ug	59670
CLSAF3478	Phospho-p62 Dok (Tyr362) Antibody	62kDa	Human, Mouse, Rat	WB	200ug	59670
CLSAF3479	Phospho-p62 Dok (Tyr398) Antibody	62kDa	Human, Mouse, Rat	WB	200ug	59670
CLSAF3480	Phospho-FANCD2 (Ser222) Antibody	166kDa	Human, Mouse, Rat	WB IHC	200ug	59670
CLSAF3481	Phospho-HDAC8 (Ser39) Antibody	42kDa	Human, Mouse, Rat	WB IHC	200ug	59670
CLSAF3482	Phospho-GTPase Activating Protein (Ser387) Antibody	72kDa	Human, Mouse, Rat	WB IHC IF/ICC	200ug	59670
CLSAF3483	Phospho-WNK1 (Thr58) Antibody	230kDa	Human, Mouse, Rat	WB IHC	200ug	59670
CLSAF3484	Phospho-GRF-1 (Tyr1105) Antibody	155kDa	Human, Mouse, Rat	WB IHC	200ug	59670
CLSAF3485	Phospho-HDAC6 (Ser22) Antibody	131kDa	Human, Mouse	WB IHC IF/ICC	200ug	59670
CLSAF3486	Phospho-p70 S6 Kinase beta (Ser423) Antibody	53kDa	Human, Mouse	WB	200ug	59670
CLSAF3487	Phospho-DARPP-32 (Thr75) Antibody	32kDa	Human, Mouse, Rat	WB IHC	200ug	59670
CLSAF3488	Phospho-DARPP-32 (Thr34) Antibody	32kDa	Human, Mouse, Rat	WB IHC IF/ICC	200ug	59670
CLSAF3489	Phospho-ALK (Tyr1507) Antibody	176kDa	Human, Mouse	WB IHC	200ug	59670
CLSAF3490	Phospho-HDAC5 (Ser259) Antibody	124kDa	Human, Mouse	WB	200ug	59670
CLSAF3491	Phospho-HDAC5 (Ser498) Antibody	124kDa	Human, Mouse	WB IHC	200ug	59670
CLSAF3492	Phospho-CaMK2 alpha/ beta/ delta (Thr305) Antibody	54kDa	Human, Mouse, Rat	WB IHC	200ug	59670
CLSAF3493	Phospho-CaMK2 (Thr286) Antibody	50kDa	Human, Mouse, Rat	WB IHC IF/ICC	200ug	59670
CLSAF3494	Phospho-AMPK β1(Ser181) Antibody	38kDa	Human, Mouse, Rat	WB IHC	200ug	59670
CLSAF3495	Phospho-IKK- gamma (Ser31) Antibody	48kDa	Human	WB IHC	200ug	59670
CLSAF3496	Phospho-IKK-γ (Ser85) Antibody	48kDa	Human	WB	200ug	59670
CLSAF4001	Phospho-p38 MAPK (Thr180/Tyr182) Antibody	43 kDa	Human, Mouse, Rat	WB IHC IF IP	200ug	59670
CLSAF4002	SNAI2 Antibody	30 kDa	Human, Mouse, Rat	WB	200ug	59670
CLSAF4004	TORC2 antibody	70 KD	Human, Mouse, Rat	WB	200ug	59670
CLSAF4007	LC3 Antibody	19kd	Hu Ms Rt	WB	200ug	59670
CLSAF4008	Niban Antibody	150kd	Human	WB IF	200ug	59670
CLSAF4009	Twist1 Antibody	29 kd	Human, Mouse, Rat	WB IHC	200ug	59670
CLSAF4010	SOX2 Antibody	35kd	Human, Mouse	WB	200ug	59670
CLSAF4011	Nanog Antibody	42kd	Human, Mouse	WB	200ug	59670
CLSAF4031	PKM1/2 Antibody	60kd	Human	WB	200ug	59670
CLSAF4034	CDK4 Antibody	34kd	Human	WB	200ug	59670
CLSAF4036	CD34 Antibody	110kd	Human, Mouse, Rat	WB	200ug	59670
CLSAF4039	N-Cadherin Antibody	140kd	Human, Mouse, Rat	WB	200ug	59670
CLSAF4041	ABCG2(CD338) Antibody	65-80kd	Human, Mouse, Rat	WB	200ug	59670
CLSAF4048	PKM2 Antibody	60kd	Human	WB	200ug	59670
CLSAF4051	ERAB Antibody	27kd	Human, Mouse, Rat	WB	200ug	59670
CLSAF4056	FOXP2 Antibody	85kd	Human, Mouse	WB	200ug	59670
CLSAF4057	FOXP4 Antibody	74kd	Human, Mouse, Rat	WB	200ug	59670
CLSAF4065	Neuroserpin Antibody	55kd	Human, Mouse, Rat	WB	200ug	59670
CLSAF4069	HMG2 Antibody	18kd	Human, Mouse	WB	200ug	59670
CLSAF4072	LIN28B Antibody	21 32kd	Human	WB	200ug	59670
CLSAF4073	Rab5 Antibody	25kd	Human, Mouse, Rat	WB	200ug	59670
CLSAF4074	Ring1A Antibody	58kd	Human, Mouse, Rat	WB	200ug	59670
CLSAF4077	WASP Antibody	53kd	Human, Mouse, Rat	WB	200ug	59670



Antibodies

HSN : 38220090

Cat#	Product Description	MW	Reactivity	Application	Pack Size	Unit Price
CLSAF4081	MAP2 Antibody	55-75(2c/2d), 280(2a/2b)kd	Human, Mouse, Rat	WB IF	200ug	59670
CLSAF4082	FOXP1 Antibody	82-90kd	Human, Mouse, Rat	WB	200ug	59670
CLSAF4084	CNPase Antibody	47kd	Human, Mouse	WB	200ug	59670
CLSAF4085	MBP(myelin basic protein) Antibody	14-33kd	Human, Mouse, Rat	WB	200ug	59670
CLSAF4088	Blimp-1 Antibody	95 100kd	Human, Mouse, Rat	WB	200ug	59670
CLSAF4089	Cdx2 Antibody	40kd	Human, Mouse, Rat	WB	200ug	59670
CLSAF4091	E2F-1 Antibody	70kd	Human, Mouse	WB	200ug	59670
CLSAF4095	Synaptophysin Antibody	38kd	Human	WB	200ug	59670
CLSAF4096	Dynamin 1 Antibody	100kd	Human, Mouse, Rat	WB	200ug	59670
CLSAF4098	DDX4 Antibody	80kd	Human, Mouse, Rat	WB	200ug	59670
CLSAF4099	b-Enolase(ENO-3) Antibody	45kd		WB	200ug	59670
CLSAF4100	E2F-2 Antibody	45kd	Human, Mouse	WB	200ug	59670
CLSAF4101	HNF-1β(TCF-2) Antibody 	45,58,61kd	Human, Mouse, Rat	WB	200ug	59670
CLSAF4102	LGR5(GPR49) Antibody	95kd	Human, Mouse	WB	200ug	59670
CLSAF4104	Rex1(ZFP42) Antibody	35kd	Human	WB	200ug	59670
CLSAF4105	Brg1 Antibody	185,200kd	Human, Mouse, Rat	WB	200ug	59670
CLSAF4112	Twist2 Antibody	18kd	Human, Mouse, Rat	WB IHC	200ug	59670
CLSAF4113	SCF Antibody	25-38kd	Human	WB	200ug	59670
CLSAF4119	ATM Antibody	350kd	Human, Mouse	WB IF	200ug	59670
CLSAF4120	ATM(Phospho-Ser1981) Antibody	350kd	Human	WB IHC	200ug	59670
CLSAF4200	Rac1 Antibody	26 kd	Human, Mouse, Rat	WB IF	200ug	59670
CLSAF4201	VEGFR3 Antibody	160kd	Human, Mouse	WB IHC IF	200ug	59670
CLSAF4202	LYVE1 Antibody	40 kd	Human, Mouse, Rat	WB	200ug	59670
CLSAF5002	IkappaB-alpha Antibody	39kDa	Human, Mouse, Rat	WB IHC	200ug	59670
CLSAF5004	GR Antibody	95kDa	Human, Mouse, Rat	WB IHC IF/ICC	200ug	59670
CLSAF5006	NF-kappaB p65 Antibody	65kDa	Human, Mouse, Rat	WB IHC	200ug	59670
CLSAF5008	SYK Antibody	80kDa	Human, Mouse, Rat	IHC IF/ICC	200ug	59670
CLSAF5010	FosB Antibody	35kDa	Human, Mouse	WB IF/ICC	200ug	59670
CLSAF5012	JAK1 Antibody	130kDa	Human, Mouse, Rat	WB IHC	200ug	59670
CLSAF5014	Chk1 Antibody	56kDa	Human	WB	200ug	59670
CLSAF5016	GSK3 beta Antibody	46kDa	Human, Mouse, Rat	WB IHC IP	200ug	59670
CLSAF5101	TSC1 Antibody	150-170 KD	Human, Mouse, Rat	WB IHC	200ug	59670
CLSAF5101	TSC1 Antibody	150 kDa	Human Mouse Rat	WB IHC	200ug	59670
CLSAF5102	Cytokeratin 13 Antibody	50 kDa	Human Mouse Rat	WB IHC	200ug	59670
CLSAF5103	Interleukin 1β Antibody	30 kDa	Human Mouse Rat	WB IHC	200ug	59670
CLSAF5104	Rab5A Antibody	24 kDa	Human Mouse Rat	WB IHC	200ug	59670
CLSAF5105	Interleukin 2 Antibody	17 kDa	Human, Rat	WB	200ug	59670
CLSAF5106	Cytokeratin 19 Antibody	44 kDa	Human, Mouse, Rat	WB IHC	200ug	59670
CLSAF5107	Interleukin 20 Antibody	20 kDa	Human, Mouse	WB	200ug	59670
CLSAF5108	Connexin 45 Antibody	45 kDa	Human, Mouse, Rat	WB IHC	200ug	59670
CLSAF5109	Insulin Antibody	11 kDa	Human, Mouse, Rat	IHC	200ug	59670
CLSAF5110	XBP1 Antibody	29 kDa	Human, Mouse, Rat	WB IHC	200ug	59670
CLSAF5111	Interleukin 12B Antibody	37 kDa	Human	WB	200ug	59670
CLSAF5112	PI3 kinase P110α Antibody	124 kDa	Human, Mouse	WB IHC	200ug	59670
CLSAF5113	CD31 Antibody	82 kDa	Human, Mouse, Rat	WB	200ug	59670
CLSAF5114	Smad9 Antibody	52 kDa	Human, Mouse, Rat	WB IHC	200ug	59670
CLSAF5115	FAST kinase Antibody	72 KD	Human, Mouse, Rat	WB	200ug	59670
CLSAF5115	FAST kinase Antibody	61 kDa	Human, Mouse, Rat	WB	200ug	59670
CLSAF5116	Connexin 26 Antibody	26 kDa	Human, Mouse, Rat	WB	200ug	59670
CLSAF5117	CD63 Antibody	25 kDa	Human	IHC	200ug	59670
CLSAF5118	Caspase 7 Antibody	34 kDa	Human	WB IHC	200ug	59670
CLSAF5119	Smad5 Antibody	52 kDa	Human, Mouse, Rat	WB IHC IF	200ug	59670
CLSAF5120	CD133 Antibody	97 kDa	Human, Mouse, Rat	WB IHC	200ug	59670
CLSAF5121	PI3 kinase P85α Antibody	83 kDa	Human, Mouse, Rat	WB IHC	200ug	59670
CLSAF5122	vinculin Antibody	130 kDa	Human, Mouse, Rat	WB IHC	200ug	59670
CLSAF5123	Interleukin 5 Antibody	15 kDa	Human, Mouse, Rat	WB IHC	200ug	59670
CLSAF5124	ANG 2 Antibody	57 kDa	Human, Mouse, Rat	WB IHC	200ug	59670
CLSAF5125	CD57 Antibody	38 kDa	Human, Mouse, Rat	IHC	200ug	59670
CLSAF5126	CD8A Antibody	25 kDa	Human	WB	200ug	59670
CLSAF5127	NGFR Antibody	45 kDa	Human, Mouse, Rat	WB	200ug	59670
CLSAF5128	Beclin 1 Antibody	52 kDa	Human, Mouse, Rat	WB	200ug	59670
CLSAF5129	nNOS Antibody	125 kDa	Human, Mouse, Rat	WB	200ug	59670
CLSAF5130	Caspase 4 Antibody	43 kDa	Human, Mouse, Rat	WB IHC	200ug	59670
CLSAF5131	VEGF Antibody	28kd	Human, Mouse, Rat	WB IHC	200ug	59670
CLSAF5131	VEGF Antibody	28 kDa	Human, Mouse, Rat	WB IHC	200ug	59670
CLSAF5132	Connexin 32 Antibody	32 kDa	Human, Mouse, Rat	WB IHC	200ug	59670
CLSAF5133	Interleukin 12A Antibody	24 kDa	Human, Mouse, Rat	WB IHC	200ug	59670
CLSAF5134	AFP Antibody	62-65 kDa	Human, Mouse, Rat	WB IHC	200ug	59670
CLSAF5135	SIRT3 antibody	29 kDa	Human, Mouse, Rat	WB IHC	200ug	59670

Antibodies
HSN : 38220090

Cat#	Product Description	MW	Reactivity	Application	Pack Size	Unit Price
CLSAF5136	Bag 1 Antibody	31 kDa	Human, Mouse, Rat	WB IHC	200ug	59670
CLSAF5137	E2F5 antibody	37 kDa	Human, Mouse, Rat	WB	200ug	59670
CLSAF5138	CD8B Antibody	23 kDa	Human	WB	200ug	59670
CLSAF5139	CD9 Antibody	25KD	Human, Mouse, Rat	WB IHC IF	200ug	59670
CLSAF5139	CD9 Antibody	25 kDa	Human, Mouse, Rat	WB IHC IF	200ug	59670
CLSAF5140	SOX2 Antibody	34 kDa	Human, Mouse, Rat	WB IHC IF	200ug	59670
CLSAF5141	Interleukin 2 receptor β Antibody	61 kDa	Human, Mouse	WB	200ug	59670
CLSAF5142	Interleukin 4 Antibody	17 kDa	Human	WB	200ug	59670
CLSAF5143	HO 2 Antibody	36 kDa	Human, Mouse	WB IHC	200ug	59670
CLSAF5144	sod2 Antibody	25 kDa	Human, Mouse, Rat	WB	200ug	59670
CLSAF5145	ZO 1 Antibody	195 kDa	Human	WB IF	200ug	59670
CLSAF5146	Interleukin 8 Antibody	11 kDa	Human	WB IHC	200ug	59670
CLSAF5147	Smad7 Antibody	50KD	Human, Mouse, Rat	WB	200ug	59670
CLSAF5147	Smad7 Antibody	46 kDa	Human, Mouse, Rat	WB	200ug	59670
CLSAF5148	EGF Antibody	133 kDa	Human, Mouse, Rat	WB IHC	200ug	59670
CLSAF5149	CD34 Antibody	120 kDa	Human, Mouse, Rat	WB	200ug	59670
CLSAF5150	EZH2 Antibody	85 kDa	Human, Mouse, Rat	WB IHC	200ug	59670
CLSAF5151	RANTES Antibody	9 kDa	Human, Mouse, Rat	WB IHC	200ug	59670
CLSAF5152	Integrin α V Antibody	116 kDa	Human, Mouse	WB IHC	200ug	59670
CLSAF5153	BMP3 Antibody	50 KD	Human, Mouse, Rat	WB IHC	200ug	59670
CLSAF5153	BMP3 Antibody	53 kDa	Human, Mouse, Rat	WB IHC	200ug	59670
CLSAF5154	Annexin I Antibody	37kd	Human, Mouse, Rat	WB IHC	200ug	59670
CLSAF5154	Annexin I Antibody	38 kDa	Human, Mouse, Rat	WB IHC	200ug	59670
CLSAF5155	Integrin α E Antibody	130 kDa	Human	WB	200ug	59670
CLSAF5156	MAP 2 Antibody	199 kDa	Human, Mouse, Rat	WB IHC	200ug	59670
CLSAF5157	Trefoil factor 2 (TFF2) Antibody	14 kDa	Human	WB	200ug	59670
CLSAF5158	Abi 1 Antibody	55 kDa	Human, Mouse, Rat	WB	200ug	59670
CLSAF5159	Annexin III Antibody	36 kDa	Human, Mouse	WB IHC	200ug	59670
CLSAF5160	Smad6 Antibody	50 KD	Human Mouse	WB IHC	200ug	59670
CLSAF5160	Smad 6 Antibody	53 kDa	Human, Mouse	WB IHC	200ug	59670
CLSAF5161	Lamin B Antibody	66 kDa	Human, Mouse, Rat	WB IHC	200ug	59670
CLSAF5162	BMP5 Antibody	52KD	Human Mouse	WB IHC	200ug	59670
CLSAF5162	BMP5 Antibody	51 kDa	Human, Mouse	WB IHC	200ug	59670
CLSAF5163	BMP2 Antibody	44 kDa	Human, Mouse, Rat	WB IHC	200ug	59670
CLSAF5164	AQP4 Antibody	34 kDa	Human, Mouse, Rat	WB IHC	200ug	59670
CLSAF5165	ACE2 Antibody	100-110	Human Mouse	WB	200ug	59670
CLSAF5165	ACE2 Antibody	92 kDa	Human, Mouse	WB	200ug	59670
CLSAF5166	SDF 1 Antibody	10 kDa	Human, Mouse, Rat	WB IHC	200ug	59670
CLSAF5167	Cathepsin G Antibody	28 kDa	Human, Mouse, Rat	WB	200ug	59670
CLSAF5168	GATA 5 Antibody	41 kDa	Human, Mouse	WB IHC	200ug	59670
CLSAF5169	AQP5 Antibody	28 kDa	Human	WB IHC	200ug	59670
CLSAF5170	Inhibin β B Antibody	45 kDa	Human, Mouse, Rat	WB	200ug	59670
CLSAF5171	Annexin II Antibody	37	Human, Mouse, Rat	WB IHC	200ug	59670
CLSAF5171	Annexin II Antibody	38 kDa	Human, Mouse, Rat	WB IHC	200ug	59670
CLSAF5172	NGF beta Antibody	26 kDa	Human, Mouse, Rat	WB IHC	200ug	59670
CLSAF5173	BBC3(PUMA) Antibody	20 kDa	Human, Mouse, Rat	WB	200ug	59670
CLSAF5174	PAI 2 Antibody	46 kDa	Human	WB IHC	200ug	59670
CLSAF5175	BMP4 Antibody	46 kDa	Human, Mouse, Rat	WB	200ug	59670
CLSAF5176	PAI 1 Antibody	46 kDa	Human	WB IHC	200ug	59670
CLSAF5177	ABCG2 Antibody	72 kDa	Human	WB IHC	200ug	59670
CLSAF5178	Apolipoprotein E Antibody	36 kDa	Human, Mouse, Rat	WB IHC	200ug	59670
CLSAF5179	PDGFA Antibody	20 kd	Human, Mouse, Rat	WB IHC	200ug	59670
CLSAF5179	PDGFA Antibody	24 kDa	Human, Mouse, Rat	WB IHC	200ug	59670
CLSAF5180	S100 A10 Antibody	11 kDa	Human, Mouse, Rat	WB IHC	200ug	59670
CLSAF5181	Cathepsin E Antibody	43 kDa	Human, Mouse, Rat	WB IHC	200ug	59670
CLSAF5182	Integrin α 3 (CD49c) Antibody	110kd	Human Mouse	WB	200ug	59670
CLSAF5182	Integrin α 3 (CD49c) Antibody	118 kDa	Human, Mouse	WB	200ug	59670
CLSAF5183	Interferon gamma Antibody	19 kDa	Human	WB IHC	200ug	59670
CLSAF5184	Angiopoietin 1 Antibody	57 kDa	Human, Mouse, Rat	WB	200ug	59670
CLSAF5185	P Glycoprotein 1 (MDR1) Antibody	141 kDa	Human, Mouse, Rat	IHC	200ug	59670
CLSAF5186	RUNX2 Antibody	50-60kd	Human Mouse	WB IHC IF	200ug	59670
CLSAF5186	RUNX2 Antibody	56 kDa	Human, Mouse	WB IHC	200ug	59670
CLSAF5187	hsc70 Antibody	70kd	Human, Mouse, Rat	WB	200ug	59670
CLSAF5187	hsc70 Antibody	70 kDa	Human, Mouse, Rat	WB	200ug	59670
CLSAF5188	RUNX3 Antibody	44 kDa	Human, Mouse	WB	200ug	59670
CLSAF5189	Cathepsin B Antibody	37 kDa	Human, Mouse, Rat	WB IHC	200ug	59670
CLSAF5190	EPO Antibody	21 kDa	Human, Mouse, Rat	WB	200ug	59670
CLSAF5191	Cathepsin D Antibody	44 kDa	Human	WB IHC	200ug	59670
CLSAF5192	VEGFD Antibody	40 kDa	Human, Mouse, Rat	WB IHC	200ug	59670
CLSAF5193	BMP7 Antibody	55KD	Human, Mouse, Rat	WB IHC	200ug	59670

Antibodies
HSN : 38220090

Cat#	Product Description	MW	Reactivity	Application	Pack Size	Unit Price
CLSAF5193	BMP7 Antibody	49 kDa	Human, Mouse, Rat	WB IHC	200ug	59670
CLSAF5194	AQP0 Antibody	37 kDa	Human, Mouse, Rat	WB IHC	200ug	59670
CLSAF5195	MyD88 Antibody	34KD	Human, Mouse, Rat	WB IHC IF	200ug	59670
CLSAF5195	MyD88 Antibody	37 kDa	Human, Mouse, Rat	WB IHC	200ug	59670
CLSAF5196	BMP6 Antibody	57 kDa	Human	WB IHC	200ug	59670
CLSAF5197	ACE1 Antibody	149 kDa	Human, Mouse, Rat	WB IHC	200ug	59670
CLSAF5198	SOD1 Antibody	18kd	Human, Mouse, Rat	WB	200ug	59670
CLSAF5198	SOD1 Antibody	149 Kd	Human, Mouse, Rat	WB	200ug	59670
CLSAF5199	caspase12 Antibody	38 kDa	Human	WB IHC	200ug	59670
CLSAF5200	Integrin α 5 (CD49e) Antibody	114 kDa	Human, Mouse, Rat	WB	200ug	59670
CLSAF5201	CUTL1 Antibody	164KD	Human Mouse	WB	200ug	59670
CLSAF5201	CUTL1 Antibody	164 kDa	Human, Mouse	WB,	200ug	59670
CLSAF5202	Patched Antibody		Human, Mouse, Rat	WB, , IHC-P	200ug	59670
CLSAF5203	T-cadherin Antibody	78 kDa	Human, Mouse, Rat	WB, IHC-P	200ug	59670
CLSAF5204	N Myc Antibody	50 KD	Human, Mouse, Rat	WB IHC	200ug	59670
CLSAF5204	N Myc Antibody	49 kDa	Human, Mouse, Rat	WB	200ug	59670
CLSAF5205	STAT3 Antibody	85 kDa	Human, Mouse, Rat	WB	200ug	59670
CLSAF5206	TOMM20 Antibody	16 kDa	Human, Mouse, Rat	WB	200ug	59670
CLSAF5207	ESA Antibody	41 kDa	Human, Mouse, Rat	WB	200ug	59670
CLSAF5208	Ki67 Antibody		Human	IHC,IF	200ug	59670
CLSAF5209	EFEMP2 Antibody	49 kDa	Human	WB,IHC,IF	200ug	59670
CLSAF5210	Cytochrome P450 17A1 Antibody	57 kDa	Human, Mouse	WB IHC IF	200ug	59670
CLSAF5211	IL 11 Antibody		Human, Mouse, Rat	IHC	200ug	59670
CLSAF5212	PRLHR Antibody	41 kDa	Human, Mouse, Rat	WB	200ug	59670
CLSAF5213	CLDN6 Antibody	23 kDa	Human, Mouse, Rat	WB IHC IF	200ug	59670
CLSAF5214	TDG antibody	46 kDa	Human, Mouse, Rat	WB	200ug	59670
CLSAF5215	HOXB5 Antibody	29 kDa	Human, Mouse	WB	200ug	59670
CLSAF5216	Claudin 5 Antibody	23 kDa	Mouseouse, Ratat, Cow, HumanuMousean, Pig	WB IHC IF	200ug	59670
CLSAF5217	SOX6 Antibody	93 kDa	Human, Mouse, Rat	ChIP/Chip, , ICC/IF, WB	200ug	59670
CLSAF5218	HMG1 Antibody	11 kDa	Human, Mouse, Rat	WB	200ug	59670
CLSAF5219	GPR120 Antibody	42 kDa	Human, Mouse, Rat	WB IF	200ug	59670
CLSAF5220	P47 Antibody	47 kDa	Human, Mouse, Rat	WB IHC IF	200ug	59670
CLSAF5221	CD147 Antibody	42 kDa	Human, Mouse, Rat	WB IHC	200ug	59670
CLSAF5222	AQP3 Antibody	31 kDa	Human, Mouse, Rat	IHC	200ug	59670
CLSAF5223	TYK2 Antibody	134 kDa.	Human	WB	200ug	59670
CLSAF5224	twist Antibody	20 kDa	Human, Mouse, Rat	WB	200ug	59670
CLSAF5225	Keratin 14 Antibody	52 kDa	Human,Mouse,Rat	WB,IHC,IF	200ug	59670
CLSAF5226	Elastin Antibody	68 kDa	Human	WB	200ug	59670
CLSAF5227	INSL3 Antibody	14 kDa	Human	WB	200ug	59670
CLSAF5228	MMP-9 Antibody	78 kDa	Human,Mouse,Rat	, IHC-P, WB	200ug	59670
CLSAF5229	Cytochrome P450 19A1 Antibody	55 kDa	Human,Mouse,Rat	WB,IHC,IF	200ug	59670
CLSAF5230	hnRNP Q Antibody	70 kDa	Human, Mouse, Rat	WB	200ug	59670
CLSAF5231	AQP1 Antibody	29 kDa.	Human, Mouse, Rat	WB	200ug	59670
CLSAF5232	EPHA5 Antibody	115 kDa	Human, Mouse, Rat	WB	200ug	59670
CLSAF5233	CD83 Antibody	23 kDa	Human	WB	200ug	59670
CLSAF5234	PKM2 Antibody	58 kDa	Human, Mouse, Rat	WB IHC	200ug	59670
CLSAF5235	DNA Polymerase α Antibody	169 kDa	Human	WB	200ug	59670
CLSAF5236	EPHB1 Antibody	110 kDa	Human, Mouse, Rat	WB	200ug	59670
CLSAF5237	SOS2 Antibody	153 kDa	Human	WB	200ug	59670
CLSAF5238	EPHA2 Antibody	108 kDa	Human, Mouse	WB	200ug	59670
CLSAF5239	CDH2 Antibody	100kd	Human, Mouse, Rat	WB	200ug	59670
CLSAF5240	Caspase 9 (Cleaved-Asp353) Antibody	10 kDa	Human, Mouse, Rat	WB IHC	200ug	59670
CLSAF5241	hnRNP H Antibody	49 kDa	Human, Mouse, Rat	WB	200ug	59670
CLSAF5242	FSHR Antibody	78 kDa	Human, Mouse, Rat	WB	200ug	59670
CLSAF5243	GRM5 Antibody	120kd	Human, Mouse, Rat	WB IF	200ug	59670
CLSAF5243	GRM5 Antibody	130 kDa	Human, Mouse, Rat	WB IF	200ug	59670
CLSAF5244	Caspase 9 (Cleaved-Asp330) Antibody	10 kDa	Human, Mouse, Rat	IHC	200ug	59670
CLSAF5245	GATA4 Antibody	46 kDa	Human, Mouse, Rat	WB	200ug	59670
CLSAF5246	EPHB2 Antibody	117 kDa	Human	WB	200ug	59670
CLSAF5247	Smad4 Antibody	65 kDa	Human, Mouse, Rat	WB	200ug	59670
CLSAF5248	Actinin α 2/3 Antibody	103 kDa	Human,Mouse,Rat	WB,IHC,IF	200ug	59670
CLSAF5249	EZH1 Antibody	85 kDa	Human,Mouse,Rat	WB,IHC	200ug	59670
CLSAF5250	VEGFB Antibody	22 kDa	Human,Mouse,Rat	WB,IHC	200ug	59670
CLSAF5251	MSHR Antibody	35 kDa	Human	WB,IF	200ug	59670
CLSAF5252	BUB3 Antibody	37 kDa	Human,Mouse,Rat	WB	200ug	59670
CLSAF5253	MOT4 Antibody	47 kDa	Human,Mouse,Rat	WB	200ug	59670
CLSAF5254	EPHA3 Antibody	110 kDa	Human,Mouse,Rat	WB IHC	200ug	59670
CLSAF5255	NOTCH2 (Cleaved-Ala1734) Antibody	110 kDa	Human,Mouse,Rat	WB	200ug	59670



Antibodies

HSN : 38220090

Cat#	Product Description	MW	Reactivity	Application	Pack Size	Unit Price
CLSAF5256	SIRT2 Antibody	43 kDa	Human,Mouse,Rat	WB	200ug	59670
CLSAF5257	EPHA1 Antibody	108 kDa	Human	WB,IF	200ug	59670
CLSAF5258	CD6 Antibody	72 kDa	Human	WB,	200ug	59670
CLSAF5259	CD55 Antibody	41 kDa	Human	WB	200ug	59670
CLSAF5260	hnRNP L Antibody	60 kDa	Human,Mouse	WB,IHC,IF	200ug	59670
CLSAF5261	hnRNP C1/C2 Antibody	33 kDa	Human,Mouse,Rat	WB,IHC,IF	200ug	59670
CLSAF5262	BUB1 Antibody	122 kDa	Human	WB,	200ug	59670
CLSAF5263	hnRNP G Antibody	42 kDa	Human,Mouse,Rat	WB,IHC,IF	200ug	59670
CLSAF5264	Collagen IV α2 Antibody	42 kDa	Human,Mouse	WB,IHC,IF	200ug	59670
CLSAF5265	CD70 Antibody	30 kDa	Human	WB,	200ug	59670
CLSAF5266	Keap1 Antibody	70 kDa	Human,Mouse,Rat	WB,IHC,IF	200ug	59670
CLSAF5267	Caspase 8 (Cleaved-Asp384) Antibody	48 kDa	Human	WB	200ug	59670
CLSAF5268	hnRNP A1 Antibody	39 kDa	Human,Mouse,Rat	WB,IHC,IF	200ug	59670
CLSAF5269	AQP12 Antibody	34 kDa	Human	WB	200ug	59670
CLSAF5270	GATA6 Antibody	45 kDa	Human,Mouse,Rat	WB	200ug	59670
CLSAF5271	EPHB4 Antibody	108 kDa	Human,Mouse	WB IHC	200ug	59670
CLSAF5272	hnRNP A2/B1 Antibody	37 kDa	Human,Mouse	WB,IF	200ug	59670
CLSAF5273	CYB5 Antibody	15 kDa	Human,Mouse,Rat	WB,IHC,IF	200ug	59670
CLSAF5274	ACHE Antibody	67 kDa	Human,Mouse,Rat	WB	200ug	59670
CLSAF5275	CD69 Antibody	23 kDa	Human,Mouse,Rat	WB	200ug	59670
CLSAF5276	hnRNP M Antibody	78 kDa	Human,Mouse,Rat	WB,IHC,IF	200ug	59670
CLSAF5277	NDUFA4 Antibody	9 kDa	Human,Mouse,Rat	WB	200ug	59670
CLSAF5278	ZEB2 Antibody	136 kDa.	Human,Mouse	WB,IHC	200ug	59670
CLSAF5279	CXCR4 Antibody	39 kDa	Human,Mouse,Rat	WB IHC	200ug	59670
CLSAF5280	CHOP antibody	25 kDa	Human,Mouse	WB,IHC	200ug	59670
CLSAF5281	CD253 Antibody	32 kDa	Human	WB,IF	200ug	59670
CLSAF5282	FZD2 Antibody	63 kDa	Human,Mouse,Rat	WB,IF	200ug	59670
CLSAF5283	PSD95 Antibody	105 kDa	Human,Mouse,Rat	WB,IHC	200ug	59670
CLSAF5284	PDCD4 Antibody		Human,Mouse,Rat	IHC	200ug	59670
CLSAF5285	MEN1 Antibody	68 kDa	Human,Mouse,Rat	WB,IHC	200ug	59670
CLSAF5286	MKP1 Antibody	39 kDa	Human,Mouse,Rat	WB,IHC,IF	200ug	59670
CLSAF5287	GRP94 Antibody	92 kDa	Human,Mouse,Rat	WB,IHC,IF	200ug	59670
CLSAF5288	Actin-pan Antibody	43KD	Human,Mouse,Rat	WB,IHC	200ug	59670
CLSAF5289	Kir6.2 Antibody	44 kDa	Human,Mouse	WB,IHC,IF	200ug	59670
CLSAF5290	LEG9 Antibody	40 KD	Human,Mouse,Rat	WBC,IF	200ug	59670
CLSAF5291	CMKLR1 Antibody	43 kDa	Human,Mouse,Rat	WB	200ug	59670
CLSAF5292	BIM Antibody	22 kDa	Human,Mouse,Rat	WB,IHC	200ug	59670
CLSAF5293	CCR7 Antibody	42 kDa	Human	WB,IF	200ug	59670
CLSAF5294	ADAM10 Antibody	84 kDa	Human	WB	200ug	59670
CLSAF5295	MGMT Antibody	22 kDa	Human,Rat	WB IHC IF	200ug	59670
CLSAF5296	Notch 2 (Cleaved-Asp1733) Antibody	110 kDa	Human,Mouse,Rat	WB,IHC,IF	200ug	59670
CLSAF5297	GPR103 Antibody	49 kDa	Human,Mouse,Rat	WB, IF	200ug	59670
CLSAF5298	NRF1 Antibody	54 kDa	Human,Mouse,Rat	WB, IF	200ug	59670
CLSAF5299	I-TRAF Antibody	47 kDa	Human,Mouse,Rat	WB	200ug	59670
CLSAF5300	LEG7 Antibody	15 KD	Human,Mouse,Rat	WB	200ug	59670
CLSAF5301	PPAR-alpha Antibody	52 kDa	Human,Mouse	WB,IF	200ug	59670
CLSAF5302	MKL1 Antibody	99 kDa	Human,Mouse	WB	200ug	59670
CLSAF5303	DCT(TRP2) Antibody	60 KD	Human,Mouse	WB,IHC,IF	200ug	59670
CLSAF5304	PERK Antibody	125 kDa	Human,Mouse,Rat	WB,IHC	200ug	59670
CLSAF5305	GORASP2 Antibody	47 kDa	Human,Mouse,Rat	WB	200ug	59670
CLSAF5306	CRFR2 Antibody	48 kDa	Human,Mouse,Rat	WB, IHC,	200ug	59670
CLSAF5307	Notch 1 (Cleaved-Val1744) Antibody	95 kDa	Human,Mouse,Rat	WB,IHC	200ug	59670
CLSAF5308	CLTR1 Antibody	39 kDa	Human	WB, IF	200ug	59670
CLSAF5309	AGER (RAGE) Antibody	48 kDa	Human	WB IHC	200ug	59670
CLSAF5309	AGER (RAGE) Antibody	42 kDa	Human,Mouse,Rat	WB,IHC,IF	200ug	59670
CLSAF5310	CRHR1 Antibody	51 kDa	Human,Mouse,Rat	WB,IF	200ug	59670
CLSAF5311	MCL1 Antibody	37 kDa	Human,Mouse,Rat	WB,IHC,IF	200ug	59670
CLSAF5312	Cytochrome P450 1A1/2 Antibody	58 kDa	Human,Mouse,Rat	WB	200ug	59670
CLSAF5313	Cyclin A1 Antibody	52 kDa	Human,Mouse,	WB,IHC,IF	200ug	59670
CLSAF5314	MYLK Antibody	211 kDa.	Human,Mouse,Rat	WB,	200ug	59670
CLSAF5315	wnt1 antibody	41 kDa	Human,Mouse	WB,IHC,IF	200ug	59670
CLSAF5316	SUCNR1 Antibody	38 kDa	Human,Mouse,Rat	WB,	200ug	59670
CLSAF5317	MRE11A Antibody	80 kDa	Human,Mouse,Rat	WB	200ug	59670
CLSAF5318	MTA1 Antibody	73 kd	Human,Mouse,Rat	WB	200ug	59670
CLSAF5319	GLR Antibody	56 kDa	Human,Mouse,Rat	WB, IF	200ug	59670
CLSAF5320	S100 A4 Antibody	12 kDa	Human,Mouse,Rat	WB	200ug	59670
CLSAF5321	MAPK10 Antibody	53 kDa	Human,Mouse,Rat	WB	200ug	59670
CLSAF5322	EDG2 Antibody	41 kDa	Human, Rat	WB,IHC,IF	200ug	59670

Antibodies
HSN : 38220090

Cat#	Product Description	MW	Reactivity	Application	Pack Size	Unit Price
CLSAF5323	AP 2 Antibody	48 kDa	Human,Mouse,Rat	WB,IHC,IF,CHIP,EMSA	200ug	59670
CLSAF5324	Synuclein β Antibody	14 kDa	Human,Mouse,Rat	WB,IHC,IF	200ug	59670
CLSAF5325	AurA Antibody	46 kDa	Human,Mouse,Rat	WB	200ug	59670
CLSAF5326	Calsenilin/KCNIP3 Antibody	29 kDa	Human,Mouse	WB,IHC,IF	200ug	59670
CLSAF5327	Integrin $\beta 5$ Antibody	88 kDa	Human, Mouse, Rat	WB	200ug	59670
CLSAF5327	Integrin $\beta 5$ Antibody	88 kDa	Human,Mouse,Rat	WB IF	200ug	59670
CLSAF5328	ANXA1 Antibody	37 KD	Human	WB	200ug	59670
CLSAF5329	PIAS4 Antibody	57 kDa	Human,Mouse	WB,IHC	200ug	59670
CLSAF5330	MMP 2 Antibody	74 kDa	Human,Mouse,Rat	WB	200ug	59670
CLSAF5331	DDX3/DEAD box Protein 3 Antibody	73 kDa	Human,Mouse,Rat	WB,IHC,IF	200ug	59670
CLSAF5332	Actin $\alpha 1$ Antibody	42 kDa	Human,Mouse,Rat	WB,IHC,IP	200ug	59670
CLSAF5333	FAS ligand Antibody	31 kDa	Human	WB,IHC	200ug	59670
CLSAF5334	Desmin Antibody	52 kDa	Human,Mouse,Rat	WB,IHC	200ug	59670
CLSAF5335	Fibronectin 1 Antibody	263 kDa	Human,Mouse,Rat	WB,IHC,IF	200ug	59670
CLSAF5336	CD40 Antibody	31 kDa	Human,Mouse	WB,IHC,IF	200ug	59670
CLSAF5337	Catenin $\alpha 1$ Antibody	100 kd	Human, Mouse, Rat	WB IHC	200ug	59670
CLSAF5337	Catenin $\alpha 1$ Antibody	100 kDa	Human,Mouse,Rat	WB,IHC	200ug	59670
CLSAF5338	HSP105 Antibody	97 kDa	Human,Mouse	WB,IHC,IF	200ug	59670
CLSAF5339	Connexin 43 Antibody	43 kDa	Human,Mouse,Rat	WB,IHC,IF	200ug	59670
CLSAF5340	DNA PK Antibody	469 kDa	Human,Mouse	WB,IHC,IF	200ug	59670
CLSAF5341	CD4 Antibody	48 kDa	Human	WB,IHC	200ug	59670
CLSAF5342	FAS Antibody	52 kDa	Human	WB,IHC	200ug	59670
CLSAF5343	CD71/TFR Antibody	49 kDa	Human,Mouse	WB,IHC	200ug	59670
CLSAF5344	FAP 1 Antibody	90 kDa	Human,Mouse,Dg,Mousek	WB, IHC-P, IHC-Fr, ICC/IF	200ug	59670
CLSAF5345	Fra 2 Antibody	35 kDa	Human,Mouse,Rat	WB,IHC	200ug	59670
CLSAF5346	Integrin $\beta 4$ Antibody	202 kDa	Human,Mouse,Rat	WB,IHC	200ug	59670
CLSAF5347	TGF β Receptor I Antibody	56 kDa.	Human,Mouse	WB,IF	200ug	59670
CLSAF5348	HDAC5 Antibody	122 kDa	Human,Mouse,Rat	WB,IHC,IF	200ug	59670
CLSAF5349	HDAC3 Antibody	49 kDa	Human,Mouse,Rat	WB,IHC,IF	200ug	59670
CLSAF5350	Claudin 4 Antibody	22 kDa	Human,Mouse,Rat	WB,IHC	200ug	59670
CLSAF5351	Actin $\gamma 2$ Antibody	42 kDa	Human,Mouse,Rat	WB,IHC	200ug	59670
CLSAF5352	Gastrin Antibody	11 kDa	Human,Mouse,	WB,IHC	200ug	59670
CLSAF5353	Keratin 15 Antibody	49 kDa	Human,Mouse,Rat	WB,IHC	200ug	59670
CLSAF5354	Fos Antibody	50 kDa	Human,Mouse,Rat	WB,IHC,IP	200ug	59670
CLSAF5355	MMP 13 Antibody	54 kDa	Human,Rat	WB,IHC,IF	200ug	59670
CLSAF5356	p18 INK Antibody	18 kDa	Human,Mouse,Rat	WB,IHC	200ug	59670
CLSAF5357	Cyclin F Antibody	87 kDa	Human	WB,IHC	200ug	59670
CLSAF5358	OCT3 Antibody	36 kDa	Human,Mouse,Rat	WB,IHC	200ug	59670
CLSAF5359	HDAC6 Antibody	131 kDa	Human,Mouse	WB,IHC	200ug	59670
CLSAF5360	p300 Antibody	300 kDa	Human	WB,IHC	200ug	59670
CLSAF5361	AurB Antibody	40 kd	Human, Mouse, Rat	WB IHC	200ug	59670
CLSAF5361	AurB Antibody	40 kDa	Human,Mouse,Rat	WB,IHC	200ug	59670
CLSAF5362	Calnexin	90 kDa	Human,Mouse,Rat	WB,IHC	200ug	59670
CLSAF5363	HSP40 Antibody	38 kDa	Human,Mouse,Rat	WB,IHC,IF	200ug	59670
CLSAF5364	Claudin 11 Antibody	22 kDa	Human,Mouse,Rat,Cow	WB IHC IF	200ug	59670
CLSAF5365	DDR1 Antibody	110 kDa	Human,Mouse,Rat	WB,	200ug	59670
CLSAF5366	GRP78 Antibody	78 kDa	Human,Mouse,Rat	WB,IHC,IF	200ug	59670
CLSAF5367	RAN Antibody	26 kDa	Human,Mouse,Rat	WB,IHC,IF	200ug	59670
CLSAF5368	HSP90A Antibody	83 kDa	Human,Mouse,Rat	WB,IHC,IF	200ug	59670
CLSAF5369	iNOS Antibody	131 kDa	Human	WB,IHC,IF	200ug	59670
CLSAF5370	Keratin 14 Antibody	52 kDa	Human,Mouse,Rat	WB,IHC,IF	200ug	59670
CLSAF5371	Prostate Apoptosis Response protein 4 Antibody	37 kDa	Human,Mouse,Rat	WB,IHC	200ug	59670
CLSAF5372	Caveolin 1 Antibody	20 kDa	Human,	WB,IF	200ug	59670
CLSAF5373	CASP4 (p20, Cleaved-Gln81) Antibody	43 kDa,25 kDa	Human	WB	200ug	59670
CLSAF5374	HSP60 Antibody	60 kDa	Human,Mouse,Rat	WB,IHC,IF	200ug	59670
CLSAF5375	Cytochrome P450 26A1 Antibody	56 kDa	Human,Mouse,Rat	WB	200ug	59670
CLSAF5376	TRAF6 Antibody	58 kDa	Human,Mouse,Rat	WB,IHC	200ug	59670
CLSAF5377	TALL-2 Antibody	27 kDa	Human,Mouse,Rat	WB,IHC,IF	200ug	59670
CLSAF5378	SOCS-1 Antibody	38 kDa	Human,Mouse,Rat	WB	200ug	59670
CLSAF5379	Integrin $\beta 1$ Antibody	160 kDa	Human,Mouse,Rat	WB	200ug	59670
CLSAF5380	TRAF3 Antibody	68 kDa	Human,Mouse,Rat	WB	200ug	59670
CLSAF5381	Caspase 6 (Cleaved-Asp179) Antibody	18 kDa	Human,Rat	WB,IHC	200ug	59670
CLSAF5382	TRAF2 Antibody	56 kDa	Human,Mouse,Rat	WB	200ug	59670
CLSAF5383	BMPR2 Antibody	115 kDa	Human,Mouse,Rat	WB	200ug	59670
CLSAF5384	P62/SQSTM1 Antibody	62 kDa	Human,Mouse,Rat	WB	200ug	59670
CLSAF5385	FOXP2 antibody	79.9 kDa	Human,Mouse,Rat	WB	200ug	59670
CLSAF5386	Glut 4 (R271) pAb	54 kDa	Human,Mouse,Rat	WB,IHC	200ug	59670
CLSAF5387	FOXP3 antibody	47 kDa	Human	WB,IHC,IF,IP	200ug	59670

Antibodies
HSN : 38220090

Cat#	Product Description	MW	Reactivity	Application	Pack Size	Unit Price
CLSAF5388	Nanog antibody	35 kDa	Human Mouse Rat	WB IHC IF	200ug	59670
CLSAF5388	Nanog antibody	35 kDa	Human	WB,IF	200ug	59670
CLSAF5389	MAOA Antibody	60 kD	Human,Mouse,Rat	WB,IHC	200ug	59670
CLSAF5390	MEF2C Antibody	51 kDa	Human,Mouse	IHC-P, ChIP, ICC/IF, WB, IHC-F	200ug	59670
CLSAF5391	IGF1 antibody	22 kDa	Human,Mouse,Rat	WB,IHC	200ug	59670
CLSAF5392	Cytochrome P450 2D6 Antibody	56 kDa	Human	WB	200ug	59670
CLSAF5393	HO-1 Antibody	33 kDa	Human,Mouse,Rat	WB	200ug	59670
CLSAF5394	HNF1 beta antibody	61 kDa	Human	WB,IF	200ug	59670
CLSAF5395	PGC1 alpha antibody	91 kDa	Human,Mouse,Rat	WB	200ug	59670
CLSAF5396	TRAF1 Antibody	46 kDa	Human,Mouse	WB IHC	200ug	59670
CLSAF5397	VDAC2 antibody	32 kDa	Human,Mouse,Rat	WB,IF	200ug	59670
CLSAF5398	MARCKS Antibody	63 kDa	Human,Mouse,Rat	WB,IHC	200ug	59670
CLSAF5399	TRXR2 Antibody	56 kDa	Human,Mouse,Rat	WB,IHC	200ug	59670
CLSAF5401	Calsenilin/KCNIP3 Antibody	29 kDa	Human,Mouse	WB,IHC,IF	200ug	59670
CLSAF5402	Ic3A/B	14.16 kDa	Human,Mouse,Rat	WB,IHC,IF	200ug	59670
CLSAF5403	GRO alpha	11 kDa	Human,Mouse,Rat	WB,IHC,IF	200ug	59670
CLSAF5404	Dematin Antibody	45 kDa	Human,Mouse	WB,IHC,IF	200ug	59670
CLSAF5405	CD3 δ Antibody	19 kDa	Human,Mouse	WB	200ug	59670
CLSAF5406	Cyclin H Antibody	37.6 kDa	Human,Mouse	WB,IHC,IF	200ug	59670
CLSAF5407	Gab2 Antibody	75kd	Human, Mouse, Rat	WB	200ug	59670
CLSAF5407	Gab2 Antibody	74 kDa	Human,Mouse,Rat	WB	200ug	59670
CLSAF5408	eIF4B Antibody	69 kDa	Human,Mouse	WB,IHC,IF	200ug	59670
CLSAF5409	Caveolin 2 Antibody	27 kDa	Human	WB,	200ug	59670
CLSAF5410	Cyclin D2 Antibody	33 kDa	Human,Mouse,Rat	WB	200ug	59670
CLSAF5411	IKK-γ Antibody	47 kDa	Human,Mouse	WB,IF	200ug	59670
CLSAF5412	LCK Antibody	58 kDa	Human,Mouse,Rat	WB	200ug	59670
CLSAF5413	TERT Antibody	127 kDa	Human	WB	200ug	59670
CLSAF5414	Stathmin 1 Antibody	17 kDa	Human,Mouse,Rat	WB,IHC	200ug	59670
CLSAF5415	Cyclin C Antibody	33 kDa	Human,Mouse,Rat	WB	200ug	59670
CLSAF5416	ATF-4 Antibody	40 kDa	Human,Mouse	WB,	200ug	59670
CLSAF5417	ATRIP Antibody	85 kDa	Human,Mouse,Rat	WB,IHC	200ug	59670
CLSAF5418	Caspase 1 Antibody	27 kDa	Human,Mouse	WB	200ug	59670
CLSAF5419	hnRPD Antibody	38 kDa	Human,Mouse	WB,IHC,IF	200ug	59670
CLSAF5420	ANXA2 Antibody	37 Kda	Human,Mouse,Rat	WB,IHC,IF	200ug	59670
CLSAF5421	Daxx Antibody	82 kDa	Human,Mouse	WB,IHC	200ug	59670
CLSAF5422	hnRNP K Antibody	51 kDa	Human,Mouse	WB	200ug	59670
CLSAF5423	MRLC2 Antibody	20 kDa	Human,Mouse,Rat	WB,IHC	200ug	59670
CLSAF5424	Dematin (Phospho-Ser403) Antibody	45 kDa	Human,Mouse	WB,IHC,IF	200ug	59670
CLSAF5425	CD3 δ (Phospho-Tyr142) Antibody	19 kDa	Human,Mouse	WB	200ug	59670
CLSAF5426	Cyclin H (Phospho-Thr315) Antibody	37.6 kDa	Human,Mouse	WB,IHC,IF	200ug	59670
CLSAF5427	Phospho-Gab2 (Ser623) Antibody	75kd	Human, Mouse, Rat	WB IHC	200ug	59670
CLSAF5427	Gab2 (Phospho-Ser623) Antibody	74 kDa	Human,Mouse,Rat	WB	200ug	59670
CLSAF5428	eIF4B (Phospho-Ser422) Antibody	69 kDa	Human,Mouse	WB,IHC,IF	200ug	59670
CLSAF5429	Caveolin 2 (Phospho-Tyr27) Antibody	27 kDa	Human	WB,	200ug	59670
CLSAF5430	Cyclin D2 (Phospho-Thr280) Antibody	33 kDa	Human,Mouse,Rat	WB	200ug	59670
CLSAF5431	IKK-γ (Phospho-Ser85) Antibody	47 kDa	Human,Mouse	WB,IF	200ug	59670
CLSAF5432	LCK (Phospho-Ser59) Antibody	58 kDa	Human,Mouse,Rat	WB	200ug	59670
CLSAF5433	Telomerase (Phospho-Ser824) Antibody	127 kDa	Human	WB	200ug	59670
CLSAF5434	Stathmin 1 (Phospho-Ser24) Antibody	17 kDa	Human,Mouse,Rat	WB,IHC	200ug	59670
CLSAF5435	Cyclin C (Phospho-Ser275) Antibody	33 kDa	Human,Mouse,Rat	WB	200ug	59670
CLSAF5436	ATF-4 (Phospho-Ser219) Antibody	40 kDa	Human,Mouse	WB,	200ug	59670
CLSAF5437	ATRIP (Phospho-Ser224) Antibody	85 kDa	Human,Mouse,Rat	WB,IHC	200ug	59670
CLSAF5438	Caspase 1 (Phospho-Ser376) Antibody	27 kDa	Human,Mouse	WB	200ug	59670
CLSAF5439	hnRPD (Phospho-Ser83) Antibody	38 kDa	Human,Mouse	WB,IHC,IF	200ug	59670
CLSAF5440	ANXA2 (Phospho-Ser26) Antibody	37 kDa	Human,Mouse,Rat	WB,IHC,IF	200ug	59670
CLSAF5441	Daxx (Phospho-Ser668) Antibody	82 kDa	Human,Mouse	WB,IHC	200ug	59670
CLSAF5442	hnRNP K (Phospho-Ser284) Antibody	51 kDa	Human,Mouse	WB	200ug	59670
CLSAF5443	Myosin regulatory light chain 2 (Phospho-Ser18) Antibody	20 kDa	Human,Mouse,Rat	WB,IHC	200ug	59670
CLSAF5444	MYPT1 Antibody	115 kDa	Human,Mouse,Rat	WB,IHC	200ug	59670
CLSAF5445	Phospho-MYPT1 (Thr853) Antibody	115 kDa	Human, Mouse, Rat	WB IHC	200ug	59670
CLSAF5445	MYPT1 (Phospho-Thr853) Antibody	115 kDa	Human,Mouse,Rat	WB,IHC	200ug	59670
CLSAF5446	MMP-8 Antibody	53 kDa	Human,Mouse,Rat	WB, IHC-P, Flow Cyt, IHC-Fr, ICC/IF	200ug	59670
CLSAF5447	PTEN Antibody	47 kDa	Human,Mouse,Rat	WB,IHC	200ug	59670
CLSAF5448	OR51E2 Antibody	35 kDa	Human,Rat	WB, ICC/IF	200ug	59670

Antibodies
HSN : 38220090

Cat#	Product Description	MW	Reactivity	Application	Pack Size	Unit Price
CLSAF5449	TGFBR2 Antibody	63 kDa	Human,Mouse	WB,IHC	200ug	59670
CLSAF5450	PKA CAT Antibody	36 kDa	Human,Mouse,Rat	WB,IHC,IF	200ug	59670
CLSAF5451	SIAH2 Antibody	36 kDa	Human,Mouse,Rat	WB,IHC,IF	200ug	59670
CLSAF5452	53BP1 Antibody	214 kDa	Human,Mouse	WB	200ug	59670
CLSAF5453	5-HT-1A Antibody	46 kDa	Human,Mouse,Rat	WB	200ug	59670
CLSAF5454	Cyclin E2 Antibody	47 kDa	Human,Mouse	WB,IHC,IF	200ug	59670
CLSAF5455	PPP1R2 Antibody	23 kDa	Human,Mouse,Rat	WB	200ug	59670
CLSAF5456	Collagen II Antibody	141 kDa	Human,Mouse,Rat	WB,IHC,IF	200ug	59670
CLSAF5457	Collagen III Antibody	138 kDa	Human,Mouse,Rat	IHC,IF	200ug	59670
CLSAF5458	GluR2/3 Antibody	100 kDa	Human,Mouse,Rat	WB,IHC	200ug	59670
CLSAF5459	GluR4 Antibody	98 kDa	Human,Mouse,Rat	WB,IHC	200ug	59670
CLSAF5460	GluR6 Antibody	95 kDa	Human,Mouse	WB,IHC,IF	200ug	59670
CLSAF5461	GluR8 Antibody	102 kDa	Human,Mouse,Rat	WB,IHC	200ug	59670
CLSAF5462	GLUT1 Antibody		Human,Mouse,Rat	WB,IHC	200ug	59670
CLSAF5463	GLUT3 Antibody	54 kDa	Human,Rat	WB,IHC,IF	200ug	59670
CLSAF5464	GRP75 Antibody	74 kDa	Human,Mouse,Rat	WB,IHC,IF	200ug	59670
CLSAF5465	p73 Antibody	73 kDa	Human	WB,IHC	200ug	59670
CLSAF5466	HSP70 Antibody	70 kDa	Human,Mouse,Rat	WB,IHC,IF	200ug	59670
CLSAF5468	COX IV antibody	17 kDa	Human,Mouse,Rat	WB,IHC,IF	200ug	59670
CLSAF5469	RhoH Antibody	21 kDa	Human,Mouse,Rat	WB,IF	200ug	59670
CLSAF5470	TNF Receptor II Antibody	48 kDa	Human,Mouse,Rat	WB,IF	200ug	59670
CLSAF5471	AIRE Antibody	58 kDa	Human,Mouse	WB,IF	200ug	59670
CLSAF5472	Ku70/80 Antibody	70, 82 kDa	Human,Mouse,Rat	WB,IHC,IF	200ug	59670
CLSAF5473	NSE Antibody	47 kDa	Human,Mouse	WB,IHC,IF	200ug	59670
CLSAF5474	HDAC10 Antibody	71 kDa	Human,Mouse,Rat	WB,IHC	200ug	59670
CLSAF5475	HDAC7 Antibody	103 kDa	Human,Mouse	WB,IHC	200ug	59670
CLSAF5476	TBP Antibody	38 kDa	Human,Mouse,Rat	WB,IHC	200ug	59670
CLSAF5477	FSHR Antibody	78 kDa	Human, Mouse, Rat	WB IHC	200ug	59670
CLSAF5478	VDAC1 Antibody		Human, Mouse, Rat	WB IHC	200ug	59670
CLSAF5479	Keratin 5 Antibody	62 kDa	Human,Mouse,Rat	WB,IHC	200ug	59670
CLSAF5480	Keratin 17 Antibody	48 kDa	Human,Mouse,Rat	WB,IHC,IF	200ug	59670
CLSAF5481	Keratin 19 Antibody	44 kDa	Human,Mouse,Rat	WB,IHC,IF	200ug	59670
CLSAF5482	Keratin 16 Antibody	51 kDa	Human,Mouse,Rat	WB,IHC	200ug	59670
CLSAF5483	HDAC1 Antibody	55 kDa	Human,Mouse,Rat	WB,IHC,IF	200ug	59670
CLSAF5484	p16 INK Antibody	16 kDa	Human,Mouse	WB	200ug	59670
CLSAF5485	p14 ARF Antibody	17 kDa	Human	WB,IHC,IF	200ug	59670
CLSAF5486	p15 INK Antibody	15 kDa	Human,Mouse,Rat	WB,IHC,IF	200ug	59670
CLSAF5487	P300/CBP Antibody	300 kDa	Human,Mouse,Rat	WB,IHC	200ug	59670
CLSAF5488	p63 Antibody	77 kDa	Human,Mouse,Rat	WB,IF	200ug	59670
CLSAF5489	PDGFR α Antibody	140 kDa	Human,Mouse,Rat	WB,IHC,IF	200ug	59670
CLSAF5490	PGP9.5 Antibody	25 kDa	Human,Mouse,Rat	WB,IHC	200ug	59670
CLSAF5491	Tyrosinase Antibody	70 kDa	Human	WB,IHC,IF	200ug	59670
CLSAF5492	TSG6 Antibody	31 kDa	Human,Mouse	WB	200ug	59670
CLSAF5493	DNMT3B Antibody	97 kDa	Human	WB,IHC,IF	200ug	59670
CLSAF5494	Catenin- γ Antibody	80 kDa	Human,Mouse,Rat	WB,IHC	200ug	59670
CLSAF5496	EPHA4 Antibody	110KD	Human, Mouse, Rat	WB	200ug	59670
CLSAF5496	EPHA4 Antibody	110 kd	Human,Mouse,Rat	WB,IHC	200ug	59670
CLSAF5498	Ki67 Antibody	358kDa	Human	WB,IHC	200ug	59670
CLSAF5499	ACV1B Antibody	56 kDa	Human,Mouse,Rat	WB,IF,	200ug	59670
CLSAF5852	Phospho-PLC- β (Ser1105) Antibody	150 KD	H M R	WB	200ug	59670
CLSAF5853	Phospho-PLC- β (Ser537) Antibody	150 KD	H M R	WB	200ug	59670
CLSAF5854	PLC- β Antibody	150 KD	H M R	WB	200ug	59670
CLSAF5855	PhosphoRE1 (S724) antibody	110 kd	H M R	WB	200ug	59670
CLSAF6001	SGK Antibody	57kDa	Human, Mouse, Rat	WB IHC	200ug	59670
CLSAF6002	IkappaB-epsilon Antibody	45kDa	Human, Mouse, Rat	WB IHC IF/ICC	200ug	59670
CLSAF6003	HSP20 Antibody	kDa	Human, Mouse, Rat	IHC	200ug	59670
CLSAF6004	Chk1 Antibody	54kDa	Human	WB IHC	200ug	59670
CLSAF6005	Chk1 Antibody	55kDa	Human	WB IF/ICC	200ug	59670
CLSAF6007	Chk1 Antibody	56kDa	Human, Mouse, Rat	WB IHC	200ug	59670
CLSAF6008	Chk1 Antibody	56kDa	Human, Mouse, Rat	WB	200ug	59670
CLSAF6009	IKK-beta Antibody	86kDa	Human, Mouse, Rat	WB IHC	200ug	59670
CLSAF6010	IKK-beta Antibody	85kDa	Human, Mouse, Rat	IHC	200ug	59670
CLSAF6011	Aurora Kinase Antibody	45kDa	Human, Mouse, Rat	WB	200ug	59670
CLSAF6012	IKK-alpha Antibody	85kDa	Human, Mouse, Rat	WB IHC	200ug	59670
CLSAF6013	IKK-alpha/beta Antibody	85kDa	Human, Mouse, Rat	WB IHC	200ug	59670
CLSAF6014	IKK-alpha/beta Antibody	85kDa	Human, Mouse, Rat	WB IHC	200ug	59670
CLSAF6015	p73 Antibody	80kDa	Human, Mouse	WB	200ug	59670
CLSAF6016	HDAC3 Antibody	48kDa	Human, Mouse, Rat	WB IHC IF/ICC	200ug	59670
CLSAF6017	Survivin Antibody	20kDa	Human, Mouse, Rat	WB IHC IF/ICC	200ug	59670
CLSAF6018	PDK1 Antibody	63kDa	Human, Mouse, Rat	WB IHC	200ug	59670

Antibodies
HSN : 38220090

Cat#	Product Description	MW	Reactivity	Application	Pack Size	Unit Price
CLSAF6019	MAP3K7 Antibody	70kDa	Human, Mouse, Rat	WB IHC	200ug	59670
CLSAF6020	FKHRL1 Antibody	97kDa	Human, Mouse, Rat	WB IHC	200ug	59670
CLSAF6021	p56 Dok-2 Antibody	56kDa	Human, Mouse	WB IHC	200ug	59670
CLSAF6022	JAK2 Antibody	125kDa	Human, Mouse, Rat	WB IHC	200ug	59670
CLSAF6023	JAK2 Antibody	125kDa	Human, Mouse, Rat	WB IHC	200ug	59670
CLSAF6025	JAK2 Antibody	125kDa	Human, Mouse, Rat	WB IF/ICC	200ug	59670
CLSAF6026	p95/NBS1 Antibody	95kDa	Human, Rat	WB IHC	200ug	59670
CLSAF6027	MITF Antibody	52kDa	Human, Mouse	WB IHC IF/ICC	200ug	59670
CLSAF6028	ROCK2 Antibody	165kDa	Human, Mouse, Rat	WB	200ug	59670
CLSAF6029	Dab1 Antibody	60kDa	Human, Mouse, Rat	WB IF/ICC	200ug	59670
CLSAF6030	MSK1 Antibody	90kDa	Human, Mouse	WB IF/ICC	200ug	59670
CLSAF6031	MSK1 Antibody	90kDa	Human, Mouse	WB IHC	200ug	59670
CLSAF6032	SNAI1 Antibody	29kDa	Human, Mouse	WB IHC IF	200ug	59670
CLSAF6033	Chk2 Antibody	60kDa	Human, Mouse, Rat	WB IHC	200ug	59670
CLSAF6037	c-Abl Antibody	55 kDa	Human, Mouse, Rat	WB IHC	200ug	59670
CLSAF6038	Abl Antibody	135kDa	Human, Mouse, Rat	WB	200ug	59670
CLSAF6039	c-Abl Antibody	135kDa	Human, Mouse	WB IHC	200ug	59670
CLSAF6042	EGFR Antibody	175kDa	Human, Mouse, Rat	WB IHC IF/ICC	200ug	59670
CLSAF6043	EGFR Antibody	134kDa	Human, Mouse, Rat	WB IHC IF/ICC	200ug	59670
CLSAF6052	EGFR Antibody	150-160kDa	Human, Mouse, Rat	WB	200ug	59670
CLSAF6053	Fos Antibody	40kDa	Human, Mouse, Rat	WB IHC	200ug	59670
CLSAF6054	MYC Antibody	50kDa	Human, Mouse, Rat	WB IHC IF/ICC	200ug	59670
CLSAF6055	MYC Antibody	57kDa	Human, Mouse, Rat	WB IHC	200ug	59670
CLSAF6056	Lamin A/C Antibody	74,65kDa	Human, Mouse, Rat	WB IHC IF/ICC	200ug	59670
CLSAF6058	Estrogen Receptor-alpha Antibody	66kDa	Human, Mouse, Mouse	WB IHC IF/ICC	200ug	59670
CLSAF6062	C-RAF Antibody	74kDa	Human, Mouse, Rat	WB IHC IF/ICC	200ug	59670
CLSAF6065	C-RAF Antibody	74kDa	Human, Mouse, Rat	WB	200ug	59670
CLSAF6066	GR Antibody	90kDa	Human, Mouse, Rat	WB IHC	200ug	59670
CLSAF6067	GR Antibody	85kDa	Human, Mouse	WB	200ug	59670
CLSAF6068	TK Antibody	25kDa	Human, Mouse, Rat	WB IHC IF/ICC	200ug	59670
CLSAF6069	HER2 Antibody	185kDa	Human, Mouse, Rat	WB IHC	200ug	59670
CLSAF6070	HER2 Antibody	185kDa	Human, Mouse, Rat	WB IHC	200ug	59670
CLSAF6071	HER2 Antibody	138kDa	Human, Mouse, Rat	WB	200ug	59670
CLSAF6073	p53 Antibody	53kDa	Human, Mouse, Rat	WB IHC IF/ICC	200ug	59670
CLSAF6082	HSP27 Antibody	27kDa	Human, Mouse, Rat	WB IHC	200ug	59670
CLSAF6083	ATPase Antibody	112kDa	Human, Mouse, Rat	WB IHC IF/ICC	200ug	59670
CLSAF6084	Amyloid beta A4 Antibody	117kDa	Human, Mouse, Rat	WB IHC IF/ICC	200ug	59670
CLSAF6085	Integrin beta3 Antibody	130kDa	Human, Mouse	WB IHC	200ug	59670
CLSAF6086	Integrin beta3 Antibody	110kDa	Human, Mouse, Rat	WB IHC	200ug	59670
CLSAF6087	elf2 alpha Antibody	38kDa	Human, Mouse, Rat	WB IHC	200ug	59670
CLSAF6088	ICAM-1 Antibody	92kDa	Human	WB	200ug	59670
CLSAF6089	c-Jun Antibody	43kDa	Human, Mouse, Rat	WB	200ug	59670
CLSAF6090	c-Jun Antibody	43kDa	Human, Mouse, Rat	WB IHC IP	200ug	59670
CLSAF6096	PKCB Antibody	77kDa	Human, Mouse, Rat	WB	200ug	59670
CLSAF6097	Keratin 8 Antibody	53kDa	Human, Mouse, Rat	WB IHC IF/ICC	200ug	59670
CLSAF6098	IR Antibody	kDa	Human	IHC IF/ICC	200ug	59670
CLSAF6099	IR Antibody	95kDa	Human, Mouse, Rat	WB	200ug	59670
CLSAF6100	Lck Antibody	56kDa	Human, Mouse, Rat	WB IF/ICC	200ug	59670
CLSAF6101	Lck Antibody	56kDa	Human, Mouse, Rat	WB	200ug	59670
CLSAF6102	Fyn Antibody	60kDa	Human, Mouse, Rat	WB	200ug	59670
CLSAF6103	Retinoblastoma Antibody	106kDa	Human, Mouse, Rat	WB IHC	200ug	59670
CLSAF6106	Progesterone Receptor Antibody	kDa	Human, Mouse, Rat	IHC IF/ICC	200ug	59670
CLSAF6107	Progesterone Receptor Antibody	99kDa	Human	WB IHC IF/ICC	200ug	59670
CLSAF6108	CDC2 Antibody	34kDa	Human, Mouse, Rat	WB	200ug	59670
CLSAF6109	ATP1alpha1/Na+K+ ATPase1 Antibody	113kDa	Human, Mouse, Rat	WB IF/ICC	200ug	59670
CLSAF6110	elF4E Antibody	25kDa	Human, Mouse, Rat	WB IHC	200ug	59670
CLSAF6111	NPM Antibody	32kDa	Human, Mouse, Rat	WB IF/ICC	200ug	59670
CLSAF6113	Tyrosine Hydroxylase Antibody	60kDa	Human, Mouse, Rat	WB IHC	200ug	59670
CLSAF6116	M-CSF Receptor Antibody	108kDa	Human, Mouse, Rat	WB	200ug	59670
CLSAF6117	Adrenergic Receptor beta2 Antibody	47kDa	Human	WB IHC IF/ICC	200ug	59670
CLSAF6118	hnRNP C1/2 Antibody	34 41kDa	Human, Mouse, Rat	WB IHC	200ug	59670
CLSAF6119	Lyn Antibody	53,56kDa	Human, Mouse, Rat	WB IHC	200ug	59670
CLSAF6120	Ret Antibody	175kDa	Human, Mouse, Rat	WB	200ug	59670
CLSAF6121	SP1 Antibody	90kDa	Human, Mouse, Rat	WB IHC IF/ICC	200ug	59670
CLSAF6122	SP1 Antibody	81kDa	Human, Mouse, Rat	WB IHC IF/ICC	200ug	59670
CLSAF6123	IGF1R Antibody	90,155kDa	Human, Mouse, Rat	WB	200ug	59670
CLSAF6124	IGF1R Antibody	145kDa	Human, Mouse, Rat	WB IHC	200ug	59670
CLSAF6125	IGF1R Antibody	90,155kDa	Human, Mouse, Rat	WB IHC	200ug	59670



Antibodies

HSN : 38220090

Cat#	Product Description	MW	Reactivity	Application	Pack Size	Unit Price
CLSAF6126	HSP90B Antibody	96 83kDa	Human, Mouse, Rat	WB IHC IP IF/ICC	200ug	59670
CLSAF6128	c-Met Antibody	155kDa	Human, Mouse, Rat	WB IF/ICC	200ug	59670
CLSAF6129	Met Antibody	145kDa	Human	WB	200ug	59670
CLSAF6130	Met Antibody	145kDa	Human, Mouse, Rat	WB	200ug	59670
CLSAF6131	Vimentin Antibody	54kDa	Human	WB IHC	200ug	59670
CLSAF6132	PDGFR beta Antibody	130kDa	Human, Mouse, Rat	WB	200ug	59670
CLSAF6133	PDGFR beta Antibody	123kDa	Human, Mouse, Rat	WB IHC IF/ICC	200ug	59670
CLSAF6134	PDGFRb Antibody	125kDa	Human, Rat	WB	200ug	59670
CLSAF6135	Histone H2A Antibody	kDa	Human, Mouse, Rat	IHC	200ug	59670
CLSAF6136	Myb Antibody	80kDa	Human, Mouse	WB	200ug	59670
CLSAF6137	Androgen Receptor Antibody	110kDa	Human	WB IHC	200ug	59670
CLSAF6139	BCL-2 Antibody	28kDa	Human, Mouse, Rat	WB IHC IF/ICC	200ug	59670
CLSAF6141	Tau Antibody	78kDa	Human, Mouse, Rat	WB	200ug	59670
CLSAF6152	KIT Antibody	145kDa	Human, Mouse	WB 1:500-1:2000	200ug	59670
CLSAF6153	c-Kit Antibody	120,145kDa	Human, Mouse, Rat	WB	200ug	59670
CLSAF6154	Bcr Antibody	160kDa	Human, Mouse	WB	200ug	59670
CLSAF6155	Bcr Antibody	145kDa	Human, Mouse	IHC	200ug	59670
CLSAF6156	FGFR1 Antibody	120kDa	Human, Mouse, Rat	WB IHC	200ug	59670
CLSAF6159	Vitamin D Receptor Antibody	48kDa	Human	WB IHC IF/ICC	200ug	59670
CLSAF6160	SRF Antibody	67kDa	Human, Mouse, Rat	WB IHC	200ug	59670
CLSAF6161	Src Antibody	60kDa	Human, Mouse, Rat	WB IHC	200ug	59670
CLSAF6162	Src Antibody	60kDa	Human, Mouse, Rat	WB	200ug	59670
CLSAF6163	Src Antibody	55kDa	Human, Mouse, Rat	WB IHC	200ug	59670
CLSAF6164	Integrin alpha4 Antibody	115kDa	Human, Mouse	WB	200ug	59670
CLSAF6165	Glycogen Synthase Antibody	85,89kDa	Human, Mouse, Rat	WB	200ug	59670
CLSAF6166	GFAP Antibody	50kDa	Human, Mouse	WB IHC IF/ICC	200ug	59670
CLSAF6167	p47 phox Antibody	44kDa	Human	WB IHC	200ug	59670
CLSAF6168	Cyclin B1 Antibody	60kDa	Human, Mouse, Rat	WB IHC IF/ICC	200ug	59670
CLSAF6169	Cyclin B1 Antibody	65kDa	Human, Mouse, Rat	WB	200ug	59670
CLSAF6170	B-RAF Antibody	kDa	Human, Mouse, Rat	IHC	200ug	59670
CLSAF6171	B-RAF Antibody	84kDa	Human, Mouse	WB IHC	200ug	59670
CLSAF6172	Ezrin Antibody	69kDa	Human, Mouse, Rat	WB	200ug	59670
CLSAF6175	Ezrin Antibody	69kDa	Human, Mouse, Rat	WB	200ug	59670
CLSAF6176	ATF2 Antibody	52kDa	Human, Mouse, Rat	WB IHC IP	200ug	59670
CLSAF6177	ATF2 Antibody	52kDa	Human, Mouse, Rat	WB IHC IP	200ug	59670
CLSAF6181	CD19 Antibody	61kDa	Human, Mouse	WB	200ug	59670
CLSAF6182	VAV1 Antibody	95kDa	Human, Mouse, Rat	WB IHC	200ug	59670
CLSAF6183	RFA2 Antibody	32kDa	Human, Mouse,	WB IHC IF/ICC	200ug	59670
CLSAF6184	GATA1 Antibody	43kDa	Human, Mouse, Rat	WB IHC IP	200ug	59670
CLSAF6185	GATA1 Antibody	43kDa	Human, Mouse, Rat	WB	200ug	59670
CLSAF6186	CD44 Antibody	90kDa	Human, Mouse, Rat	WB	200ug	59670
CLSAF6187	Histone H2A.X Antibody	15kDa	Human, Mouse, Rat	WB IHC	200ug	59670
CLSAF6188	CREB Antibody	43kDa	Human, Mouse, Rat	WB IHC IF/ICC	200ug	59670
CLSAF6189	CREB Antibody	43kDa	Human, Mouse, Rat	WB IHC	200ug	59670
CLSAF6190	PDGFRa Antibody	110kDa	Human, Mouse, Rat	WB	200ug	59670
CLSAF6191	PECAM-1 Antibody	82kDa	Human, Mouse, Rat	WB IHC IF/ICC	200ug	59670
CLSAF6192	PLCG2 Antibody	150kDa	Human, Mouse, Rat	WB IHC	200ug	59670
CLSAF6193	Stathmin 1 Antibody	19kDa	Human, Mouse, Rat	WB IHC IF/ICC	200ug	59670
CLSAF6196	PKC alpha Antibody	80kDa	Human, Mouse, Rat	WB IHC	200ug	59670
CLSAF6197	PKC-pan Antibody	83kDa	Human, Mouse, Rat	WB IHC IF/ICC	200ug	59670
CLSAF6198	JunB Antibody	38kDa	Human, Mouse	WB IHC IP	200ug	59670
CLSAF6199	Connexin 43 Antibody	43kDa	Human, Mouse, Rat	WB	200ug	59670
CLSAF6200	JunD Antibody	38kDa	Human, Mouse, Rat	WB IHC IP	200ug	59670
CLSAF6201	Synapsin Antibody	77kDa	Human, Mouse, Rat	WB	200ug	59670
CLSAF6202	C/EBP-beta Antibody	36kDa	Human, Mouse, Rat	WB IHC	200ug	59670
CLSAF6203	IGFBP-3 Antibody	31kDa	Human, Mouse	WB IHC	200ug	59670
CLSAF6204	VEGFR1 Antibody	kDa	Human, Mouse, Rat	WB 1:500-1:2000	200ug	59670
CLSAF6205	PTP1B Antibody	49kDa	Human, Mouse, Rat	WB IHC	200ug	59670
CLSAF6206	Vinculin Antibody	kDa	Human, Mouse, Rat	IHC IF/ICC	200ug	59670
CLSAF6207	GABA-RB Antibody	54kDa	Human, Mouse, Rat	WB IHC	200ug	59670
CLSAF6208	ATF1 Antibody	29kDa	Human, Mouse	WB IHC	200ug	59670
CLSAF6209	PLCG1 Antibody	150kDa	Human, Mouse, Rat	WB IHC	200ug	59670
CLSAF6210	PLCG1 Antibody	150kDa	Human, Mouse, Rat	WB IHC	200ug	59670
CLSAF6211	Epo-R Antibody	65kDa	Human, Mouse, Rat	WB IF/ICC	200ug	59670
CLSAF6212	Elk1 Antibody	62kDa	Human, Mouse, Rat	WB IHC IP	200ug	59670
CLSAF6213	Elk1 Antibody	62kDa	Human, Mouse, Rat	WB IHC IP	200ug	59670
CLSAF6214	TNNI3 Antibody	28kDa	Human, Mouse, Rat	WB IHC	200ug	59670
CLSAF6215	TNNI3 Antibody	26kDa	Human, Mouse, Rat	WB IHC	200ug	59670
CLSAF6216	PKR Antibody	74kDa	Human	WB IHC	200ug	59670



Antibodies

HSN : 38220090

Cat#	Product Description	MW	Reactivity	Application	Pack Size	Unit Price
CLSAF6217	NF-kappaB p105/p50 Antibody	105kDa	Human, Mouse	WB IHC IF/ICC	200ug	59670
CLSAF6222	Filamin A Antibody	280kDa	Human, Mouse, Rat	WB IHC	200ug	59670
CLSAF6223	Synaptotagmin Antibody	65kDa	Human, Mouse, Rat	WB IHC	200ug	59670
CLSAF6224	Synaptotagmin Antibody	65kDa	Human, Mouse, Rat	WB IHC	200ug	59670
CLSAF6225	CBL Antibody	120kDa	Human, Mouse, Rat	WB IHC	200ug	59670
CLSAF6226	p70 S6 Kinase Antibody	70kDa	Human, Mouse, Rat	WB IHC IF/ICC	200ug	59670
CLSAF6232	Cofilin Antibody	19kDa	Human, Mouse, Rat	WB	200ug	59670
CLSAF6233	GATA3 Antibody	47kDa	Human, Mouse	WB IHC IF/ICC	200ug	59670
CLSAF6234	Cyclin D1 Antibody	33kDa	Human, Mouse, Rat	WB	200ug	59670
CLSAF6235	Cyclin E1 Antibody	48kDa	Human	WB IHC IF/ICC	200ug	59670
CLSAF6236	CDK1/CDC2 Antibody	34kDa	Human, Mouse, Rat	WB	200ug	59670
CLSAF6237	CDK2 Antibody	34kDa	Human, Mouse, Rat	WB	200ug	59670
CLSAF6239	IkappaB-alpha Antibody	35kDa	Human, Mouse, Rat	WB 1:500-1:2000	200ug	59670
CLSAF6240	ERK1/2 Antibody	44+42kDa	Human, Mouse, Rat	WB	200ug	59670
CLSAF6241	PI3-kinase p85-alpha Antibody	85 KD	Human, Mouse, Rat	WB	200ug	59670
CLSAF6242	PI3-kinase p85-alpha/gamma Antibody	54,83kDa	Human, Mouse, Rat	WB IHC IF/ICC	200ug	59670
CLSAF6243	MKP-1/2 Antibody	41kDa	Human, Mouse, Rat	WB IHC	200ug	59670
CLSAF6244	SHP-1 Antibody	67kDa	Human, Mouse, Rat	WB IHC	200ug	59670
CLSAF6245	Shc Antibody	46,52,66kDa	Human, Mouse, Rat	WB IHC IP	200ug	59670
CLSAF6246	Shc Antibody	46,52,66kDa	Human, Mouse, Rat	WB IHC	200ug	59670
CLSAF6247	eNOS Antibody	140kDa	Human, Mouse, Rat	WB	200ug	59670
CLSAF6248	eNOS Antibody	140kDa	Human, Mouse, Rat	WB	200ug	59670
CLSAF6249	nNOS Antibody	120kDa	Human, Mouse, Rat	WB IF/ICC	200ug	59670
CLSAF6250	MARCKS Antibody	kDa	Human, Mouse, Rat	WB IF/ICC	200ug	59670
CLSAF6251	Cyclin D3 Antibody	32kDa	Human, Mouse, Rat	WB IHC	200ug	59670
CLSAF6252	CDC25A Antibody	60kDa	Human, Mouse, Rat	WB	200ug	59670
CLSAF6256	CDC25B Antibody	65kDa	Human, Mouse, Rat	WB IF/ICC	200ug	59670
CLSAF6257	CDC25B Antibody	64kDa	Human	WB IHC IF/ICC	200ug	59670
CLSAF6258	CDC25C Antibody	60kDa	Human	WB IHC	200ug	59670
CLSAF6259	Akt Antibody	55kDa	Human, Mouse, Rat	WB IHC	200ug	59670
CLSAF6261	Akt Antibody	55kDa	Human, Mouse, Rat	WB IHC IF/ICC	200ug	59670
CLSAF6264	Akt2 Antibody	60kDa	Human, Mouse, Rat	WB IHC	200ug	59670
CLSAF6265	VE-Cadherin Antibody	120kDa	Human, Mouse	WB	200ug	59670
CLSAF6266	Catenin-β Antibody	92kDa	Human, Mouse, Rat	WB IHC IF	200ug	59670
CLSAF6270	iNOS Antibody	131kDa	Human, Mouse, Rat	WB	200ug	59670
CLSAF6271	Merlin Antibody	70kDa	Human, Mouse, Rat	WB	200ug	59670
CLSAF6272	IRS-1 Antibody	kDa	Human, Mouse, Rat	IHC	200ug	59670
CLSAF6273	IRS-1 Antibody	180kDa	Human, Mouse, Rat	WB IHC IF/ICC	200ug	59670
CLSAF6276	ADD1 Antibody	80kDa	Human, Mouse, Rat	WB IHC IP IF/ICC	200ug	59670
CLSAF6277	CHOP Antibody	19kDa	Human, Mouse	WB IHC IF/ICC	200ug	59670
CLSAF6278	AhR Antibody	96kDa	Human, Mouse, Rat	WB IHC IF/ICC	200ug	59670
CLSAF6281	VEGFR2 Antibody	152kDa	Human, Mouse, Rat	WB IHC IF	200ug	59670
CLSAF6282	MEK2 Antibody	44kDa	Human, Mouse, Rat	WB IHC IP	200ug	59670
CLSAF6283	SREBP-1 Antibody	122kDa	Human, Rat	WB IHC	200ug	59670
CLSAF6284	PPAR-gamma Antibody	57kDa	Human, Mouse, Rat	WB IHC	200ug	59670
CLSAF6285	Synuclein Antibody	18kDa	Human, Mouse, Rat	WB IHC	200ug	59670
CLSAF6286	Synuclein-alpha Antibody	18kDa	Human, Mouse, Rat	WB	200ug	59670
CLSAF6288	BRCA1 Antibody	220kDa	Human, Rat	IHC	200ug	59670
CLSAF6289	BRCA1 Antibody	220kDa	Human	WB IHC	200ug	59670
CLSAF6290	p21 Cip1 Antibody	26kDa	Human, Mouse, Rat	WB	200ug	59670
CLSAF6291	CD130/gp130 Antibody	160kDa	Human, Mouse	WB IHC IF/ICC	200ug	59670
CLSAF6292	VHL Antibody	kDa	Human, Mouse, Rat	IHC	200ug	59670
CLSAF6293	STAT3 Antibody	86kDa	Human, Mouse, Rat	WB IHC	200ug	59670
CLSAF6294	STAT3 Antibody	86kDa	Human, Mouse, Rat	WB IHC	200ug	59670
CLSAF6295	STAT3 Antibody	86kDa	Human, Mouse, Rat	WB IHC	200ug	59670
CLSAF6296	Calcium Sensing Receptor Antibody	140kDa	Human, Mouse, Rat	WB IHC	200ug	59670
CLSAF6297	HNF4 alpha Antibody	52kDa	Human, Mouse, Rat	WB	200ug	59670
CLSAF6298	COT Antibody	60kDa	Human, Mouse, Rat	WB IHC IF/ICC	200ug	59670
CLSAF6300	STAT1 Antibody	84kDa	Human, Mouse, Rat	WB IHC IP	200ug	59670
CLSAF6301	STAT6 Antibody	94kDa	Human, Mouse, Rat	WB IHC	200ug	59670
CLSAF6302	STAT6 Antibody	94kDa	Human, Mouse, Rat	WB IHC IP	200ug	59670
CLSAF6303	STAT5A Antibody	90kDa	Human, Mouse, Rat	WB IHC	200ug	59670
CLSAF6305	STAT5A Antibody	90kDa	Human, Mouse, Rat	WB IHC	200ug	59670
CLSAF6306	GluR1 Antibody	102kDa	Human, Mouse, Rat	WB IHC IF/ICC	200ug	59670
CLSAF6307	GluR2 Antibody	99kDa	Human, Mouse, Rat	WB IHC	200ug	59670
CLSAF6308	mTOR Antibody	289kDa	Human, Mouse, Rat	WB IHC	200ug	59670
CLSAF6311	Caspase 3 Antibody	37kDa	Human, Mouse, Rat	WB IHC	200ug	59670
CLSAF6312	ZAP-70 Antibody	70kDa	Human, Mouse, Rat	WB IHC	200ug	59670
CLSAF6313	ZAP-70 Antibody	kDa	Human, Mouse, Rat	IHC	200ug	59670
CLSAF6314	SYK Antibody	72kDa	Human, Mouse, Rat	WB IHC	200ug	59670

Antibodies
HSN : 38220090

Cat#	Product Description	MW	Reactivity	Application	Pack Size	Unit Price
CLSAF6315	SYK Antibody	72kDa	Human, Mouse, Rat	WB IHC	200ug	59670
CLSAF6316	GATA4 Antibody	48kDa	Human, Mouse, Rat	WB IF/ICC	200ug	59670
CLSAF6317	GATA4 Antibody	48kDa	Human, Mouse, Rat	WB IF/ICC	200ug	59670
CLSAF6318	JNK1/2/3 Antibody	46+54kDa	Human, Mouse, Rat	WB IF/ICC	200ug	59670
CLSAF6319	SAPK/JNK Antibody	46,54kDa	Human, Mouse, Rat	WB IHC IF/ICC	200ug	59670
CLSAF6321	SEK1/MKK4 Antibody	44kDa	Human, Mouse, Rat	WB	200ug	59670
CLSAF6322	SEK1/MKK4 Antibody	kDa	Human, Mouse, Rat	IHC	200ug	59670
CLSAF6323	Crkl Antibody	40kDa	Human, Mouse, Rat	WB IHC IF/ICC	200ug	59670
CLSAF6324	p27 Kip1 Antibody	27kDa	Human, Mouse, Rat	WB	200ug	59670
CLSAF6327	MKK3 Antibody	40kDa	Human, Mouse, Rat	WB IHC	200ug	59670
CLSAF6328	YAP Antibody	65kDa	Human, Mouse, Rat	WB	200ug	59670
CLSAF6329	c-PLA2 Antibody	110kDa	Human, Mouse, Rat	WB IHC IF/ICC	200ug	59670
CLSAF6330	SOX9 Antibody	56kDa	Human, Mouse	WB IHC IF/ICC	200ug	59670
CLSAF6331	Paxillin Antibody	68kDa	Human, Mouse, Rat	WB IHC	200ug	59670
CLSAF6332	Paxillin Antibody	68kDa	Human, Mouse, Rat	WB IHC	200ug	59670
CLSAF6333	C/EBP-alpha Antibody	30,43kDa	Human, Mouse, Rat	WB IHC	200ug	59670
CLSAF6334	Tuberin/TSC2 Antibody	200kDa	Human, Mouse, Rat	WB IHC	200ug	59670
CLSAF6335	GSK3 alpha/beta Antibody	51,46kDa	Human, Mouse, Rat	WB IHC	200ug	59670
CLSAF6336	GSK3 alpha Antibody	51kDa	Human, Mouse, Rat	WB IHC IP	200ug	59670
CLSAF6337	VASP Antibody	46+50kDa	Human, Mouse, Rat	WB IHC	200ug	59670
CLSAF6338	VASP Antibody	46+50kDa	Human, Mouse, Rat	WB	200ug	59670
CLSAF6339	CCR5 Antibody	40kDa	Human, Mouse, Rat	WB 1:500-1:2000	200ug	59670
CLSAF6340	STAT5B Antibody	90kDa	Human, Mouse, Rat	WB IHC	200ug	59670
CLSAF6341	ETK Antibody	78kDa	Human, Mouse	WB IHC IF/ICC	200ug	59670
CLSAF6342	STAT2 Antibody	113kDa	Human, Rat	WB IHC	200ug	59670
CLSAF6343	EFNB1/2 Antibody	59kDa	Human, Mouse, Rat	WB IHC	200ug	59670
CLSAF6344	LIMK1/2 Antibody	72kDa	Human, Mouse, Rat	WB IHC	200ug	59670
CLSAF6345	LIMK1 Antibody	70kDa	Human, Mouse, Rat	WB	200ug	59670
CLSAF6346	LIMK2 Antibody	72kDa	Human, Mouse, Rat	WB	200ug	59670
CLSAF6347	Ataxin 1 Antibody	87 kDa	Human, Mouse	WB IHC IF/ICC	200ug	59670
CLSAF6348	Caspase 9 Antibody	46kDa	Human, Mouse, Rat	WB IHC IF/ICC	200ug	59670
CLSAF6349	HDAC4 Antibody	119kDa	Human, Mouse, Rat	WB	200ug	59670
CLSAF6350	p130 Cas Antibody	93 130kDa	Human, Mouse, Rat	WB IHC	200ug	59670
CLSAF6351	PTEN Antibody	54kDa	Human, Mouse, Rat	WB IHC	200ug	59670
CLSAF6352	RhoA Antibody	22kDa	Human, Mouse, Rat	WB IHC	200ug	59670
CLSAF6353	Calmodulin Antibody	17kDa	Human, Mouse, Rat	WB IHC IF/ICC	200ug	59670
CLSAF6354	S6 Ribosomal Protein Antibody	32kDa	Human, Mouse, Rat	WB	200ug	59670
CLSAF6355	Histone H4 Antibody	11kDa	Human, Mouse, Rat	WB IHC IF/ICC	200ug	59670
CLSAF6356	14-3-3 zeta Antibody	28kDa	Human, Mouse, Rat	WB IHC IP IF/ICC	200ug	59670
CLSAF6357	14-3-3 zeta/delta Antibody	28kDa	Human, Mouse, Rat	WB IHC IF/ICC	200ug	59670
CLSAF6358	Histone H3.1 Antibody	17kDa	Human, Mouse, Rat	WB	200ug	59670
CLSAF6359	Histone H3 Antibody	17kDa	Human, Mouse, Rat	WB IHC	200ug	59670
CLSAF6361	ADAM 17 Antibody	93 kDa	Human, Mouse, Rat	WB	200ug	59670
CLSAF6362	Smad3 Antibody	58kDa	Human, Mouse, Rat	WB IHC	200ug	59670
CLSAF6367	Smad2/3 Antibody	60kDa	Human, Mouse, Rat	WB	200ug	59670
CLSAF6368	XIAP Antibody	57kDa	Human, Mouse, Rat	WB IHC	200ug	59670
CLSAF6369	FOXO4 Antibody	65kDa	Human, Mouse	WB IF/ICC	200ug	59670
CLSAF6370	AFX Antibody	65kDa	Human, Mouse	WB IHC	200ug	59670
CLSAF6371	CDK5 Antibody	33kDa	Human, Mouse, Rat	WB IHC	200ug	59670
CLSAF6372	HSF1 Antibody	82kDa	Human, Mouse	WB IHC	200ug	59670
CLSAF6373	NF-kappaB p100/p52 Antibody	100kDa	Human, Mouse, Rat	WB IHC IP	200ug	59670
CLSAF6376	MDM2 Antibody	90kDa	Human, Mouse	WB IF/ICC	200ug	59670
CLSAF6377	E2F1 Antibody	47kDa	Human, Mouse	WB	200ug	59670
CLSAF6379	AML1 Antibody	50kDa	Human, Mouse, Rat	WB IHC IF/ICC	200ug	59670
CLSAF6380	RelB Antibody	70kDa	Human, Mouse	WB	200ug	59670
CLSAF6381	MEF2A Antibody	55kDa	Human, Mouse, Rat	WB IHC	200ug	59670
CLSAF6382	MEF2A Antibody	kDa	Human, Mouse, Rat	IHC	200ug	59670
CLSAF6383	MEK1 Antibody	45kDa	Human, Mouse, Rat	WB IHC	200ug	59670
CLSAF6384	MEK1/2 Antibody	45kDa	Human, Mouse, Rat	WB	200ug	59670
CLSAF6385	MEK1/2 Antibody	45kDa	Human, Mouse, Rat	WB IHC	200ug	59670
CLSAF6386	Caveolin-1 Antibody	23kDa	Human, Mouse, Rat	WB	200ug	59670
CLSAF6387	NF-kappaB p65 Antibody	65kDa	Human, Mouse, Rat	WB IHC IF IP	200ug	59670
CLSAF6394	PKC theta Antibody	80kDa	Human, Mouse, Rat	WB	200ug	59670
CLSAF6395	Rel Antibody	78kDa	Human	WB IHC	200ug	59670
CLSAF6396	Dynamin-1 Antibody	97kDa	Human, Mouse, Rat	WB IHC	200ug	59670
CLSAF6397	FAK Antibody	119kDa	Human, Mouse, Rat	WB IHC	200ug	59670
CLSAF6402	HSL Antibody	81+83kDa	Human, Mouse, Rat	WB IHC	200ug	59670
CLSAF6403	HSL Antibody	85kDa	Human, Mouse, Rat	WB IHC	200ug	59670
CLSAF6405	PKC zeta Antibody	80kDa	Human, Mouse, Rat	WB IHC IF/ICC	200ug	59670



Antibodies

HSN : 38220090

Cat#	Product Description	MW	Reactivity	Application	Pack Size	Unit Price
CLSAF6406	NMDAR1 Antibody	130kDa	Human, Mouse, Rat	WB IHC IF/ICC	200ug	59670
CLSAF6407	NMDAR1 Antibody	120kDa	Human, Mouse, Rat	WB IHC	200ug	59670
CLSAF6408	PKC delta Antibody	78kDa	Human	WB IHC	200ug	59670
CLSAF6409	PKC delta Antibody	77kDa	Human, Mouse, Rat	WB 1:500-1:2000	200ug	59670
CLSAF6410	PKCD Antibody	78kDa	Human, Mouse, Rat	WB	200ug	59670
CLSAF6411	Caldesmon Antibody	93kDa	Human, Mouse, Rat	WB IHC IF/ICC	200ug	59670
CLSAF6412	SHP-2 Antibody	70kDa	Human, Mouse, Rat	WB IHC	200ug	59670
CLSAF6413	SHP-2 Antibody	72kDa	Human, Mouse, Rat	WB IHC	200ug	59670
CLSAF6414	BCL-XL Antibody	30kDa	Human, Mouse, Rat	WB IHC IF/ICC	200ug	59670
CLSAF6415	BCL-XL Antibody	30kDa	Human, Mouse, Rat	WB IHC	200ug	59670
CLSAF6416	FOXO1A Antibody	70kDa	Human, Mouse, Rat	WB IHC IF/ICC	200ug	59670
CLSAF6417	FKHR Antibody	69kDa	Human, Mouse, Rat	WB IHC	200ug	59670
CLSAF6418	FKHR Antibody	69kDa	Human, Mouse, Rat	WB IHC	200ug	59670
CLSAF6419	FOXO1/3/4-pan Antibody	78kDa	Human, Mouse, Rat	WB IHC	200ug	59670
CLSAF6420	NFAT4 Antibody	115kDa	Human, Mouse	WB	200ug	59670
CLSAF6421	ACC1 Antibody	265kDa	Human, Mouse, Rat	WB IHC	200ug	59670
CLSAF6422	AMPK1 Antibody	62kDa	Human, Mouse, Rat	WB IHC	200ug	59670
CLSAF6423	AMPK alpha Antibody	62kDa	Human, Mouse, Rat	WB IHC	200ug	59670
CLSAF6424	PAK1 Antibody	60kDa	Human, Mouse, Rat	WB IHC IF/ICC	200ug	59670
CLSAF6425	NMDAR2B Antibody	165kDa	Human, Mouse, Rat	WB	200ug	59670
CLSAF6426	NMDAR2B Antibody	140kDa	Human, Mouse, Rat	WB	200ug	59670
CLSAF6427	G3BP-1 Antibody	60kDa	Human, Mouse	WB IHC	200ug	59670
CLSAF6428	BIK Antibody	23kDa	Human	WB IHC IF/ICC	200ug	59670
CLSAF6429	GAB1 Antibody	110kDa	Human, Mouse	WB	200ug	59670
CLSAF6430	Pin1 Antibody	18kDa	Human, Mouse, Rat	WB IF/ICC	200ug	59670
CLSAF6431	4E-BP1 Antibody	18kDa	Human, Mouse, Rat	WB IHC	200ug	59670
CLSAF6432	4E-BP1 Antibody	18kDa	Human, Mouse, Rat	WB IHC	200ug	59670
CLSAF6433	HDAC1 Antibody	55kDa	Human, Mouse, Rat	WB IHC	200ug	59670
CLSAF6434	CaMK2-beta/gamma/delta Antibody	50+65kDa	Human, Mouse, Rat	WB IHC	200ug	59670
CLSAF6435	IL-10R alpha Antibody	63kDa	Human	WB IF/ICC	200ug	59670
CLSAF6436	Cortactin Antibody	85kDa	Human, Mouse, Rat	WB	200ug	59670
CLSAF6437	Cortactin Antibody	85kDa	Human, Mouse, Rat	WB IHC	200ug	59670
CLSAF6438	IRF3 Antibody	57kDa	Human	WB IHC IF/ICC	200ug	59670
CLSAF6439	SMC1 Antibody	145kDa	Human, Mouse	WB IHC	200ug	59670
CLSAF6441	STAT4 Antibody	86kDa	Human, Mouse, Rat	WB IHC IP	200ug	59670
CLSAF6442	Caspase 8 Antibody	55kDa	Human, Mouse, Rat	WB IHC	200ug	59670
CLSAF6443	PKD1/PKC μ Antibody	115kDa	Human, Mouse, Rat	WB IHC	200ug	59670
CLSAF6444	PKD1/2/3/PKC μ Antibody	115kDa	Human, Mouse, Rat	WB	200ug	59670
CLSAF6445	HER4 Antibody	kDa	Human, Mouse, Rat	IHC IF/ICC	200ug	59670
CLSAF6446	PPAR-BP Antibody	168kDa	Human, Mouse	WB IF/ICC	200ug	59670
CLSAF6448	IkappaB-beta Antibody	37kDa	Human, Mouse	WB	200ug	59670
CLSAF6449	Smad2 Antibody	58kDa	Human, Mouse, Rat	WB IHC IF/ICC	200ug	59670
CLSAF6451	Smad1 Antibody	60kDa	Human, Mouse, Rat	WB IHC	200ug	59670
CLSAF6452	Smad1 Antibody	60kDa	Human, Mouse	WB IF/ICC	200ug	59670
CLSAF6453	LKB1 Antibody	65 kDa	Human, Mouse	WB IHC IF/ICC	200ug	59670
CLSAF6454	LKB1 Antibody	65kDa	Human, Mouse	WB	200ug	59670
CLSAF6456	p38 MAPK Antibody	43kDa	Human, Mouse, Rat	WB IHC IF/ICC	200ug	59670
CLSAF6458	CDC37 Antibody	44kDa	Human, Mouse, Rat	WB IHC IF/ICC	200ug	59670
CLSAF6459	DRP-2 Antibody	62kDa	Human, Mouse, Rat	WB IHC IF/ICC	200ug	59670
CLSAF6460	CaMK4 Antibody	60kDa	Human, Mouse, Rat	WB IHC IF/ICC	200ug	59670
CLSAF6461	Trk B Antibody	145kDa	Human, Mouse, Rat	IHC	200ug	59670
CLSAF6462	Trk B Antibody	92kDa	Human, Mouse, Rat	WB IHC	200ug	59670
CLSAF6463	Syntaxin 1A Antibody	35kDa	Human, Mouse, Rat	WB IHC IF/ICC	200ug	59670
CLSAF6465	PDCD4 Antibody	51kDa	Human, Mouse, Rat	WB IF/ICC	200ug	59670
CLSAF6466	FRS2 Antibody	85kDa	Human, Mouse	WB	200ug	59670
CLSAF6467	BLNK Antibody	50kDa	Human, Mouse	WB IHC	200ug	59670
CLSAF6468	ATRIP Antibody	80kDa	Human, Mouse, Rat	WB IHC IF/ICC	200ug	59670
CLSAF6469	Estrogen Receptor-beta Antibody	59kDa	Human, Mouse, Rat	WB IF/ICC	200ug	59670
CLSAF6470	HDAC2 Antibody	55kDa	Human, Mouse, Rat	WB IHC	200ug	59670
CLSAF6471	BAD Antibody	23kDa	Human, Mouse, Rat	WB IHC	200ug	59670
CLSAF6472	BAD Antibody	23kDa	Human, Mouse, Rat	WB IHC	200ug	59670
CLSAF6473	CPI17alpha Antibody	22kDa	Human, Mouse, Rat	WB IHC IF/ICC	200ug	59670
CLSAF6474	SirT1 Antibody	75+110-150kDa	Human, Mouse	WB IHC	200ug	59670
CLSAF6475	AurB Antibody	39kDa	Human, Mouse, Rat	WB IF/ICC	200ug	59670
CLSAF6476	ASK1 Antibody	155kDa	Human	WB IHC	200ug	59670
CLSAF6477	ASK1 Antibody	155kDa	Human, Mouse, Rat	WB IHC	200ug	59670
CLSAF6478	p62 Dok Antibody	62kDa	Human, Mouse, Rat	WB IHC	200ug	59670
CLSAF6479	p62 Dok Antibody	62kDa	Human, Mouse, Rat	WB IHC	200ug	59670
CLSAF6480	FANCD2 Antibody	166kDa	Human, Mouse, Rat	WB IHC	200ug	59670
CLSAF6481	HDAC8 Antibody	42kDa	Human, Mouse, Rat	WB IHC	200ug	59670

Antibodies
HSN : 38220090

Cat#	Product Description	MW	Reactivity	Application	Pack Size	Unit Price
CLSAF6482	GTPase Activating Protein Antibody	72kDa	Human, Mouse, Rat	WB IF/ICC	200ug	59670
CLSAF6483	WNK1 Antibody	230kDa	Human, Mouse, Rat	WB IHC	200ug	59670
CLSAF6484	GRF-1 Antibody	155kDa	Human, Mouse, Rat	WB 1:500-1:2000	200ug	59670
CLSAF6485	HDAC6 Antibody	131kDa	Human, Mouse	WB IHC IF/ICC	200ug	59670
CLSAF6486	p70 S6 Kinase beta Antibody	42kDa	Human, Mouse	WB	200ug	59670
CLSAF6487	DARPP-32 Antibody	32kDa	Human, Mouse, Rat	WB IHC	200ug	59670
CLSAF6488	DARPP-32 Antibody	32kDa	Human, Mouse, Rat	WB IHC	200ug	59670
CLSAF6489	ALK Antibody	170kDa	Human, Mouse	WB	200ug	59670
CLSAF6490	HDAC5 Antibody	124kDa	Human, Mouse	WB IHC	200ug	59670
CLSAF6491	HDAC5 Antibody	124kDa	Human, Mouse	WB IHC	200ug	59670
CLSAF6492	CaMK2 alpha/beta/delta Antibody	54kDa	Human, Mouse, Rat	WB IHC	200ug	59670
CLSAF6493	CaMK2 alpha/delta Antibody	50kDa	Human, Mouse, Rat	WB IHC IF/ICC	200ug	59670
CLSAF6494	AMPK β1 Antibody	38kDa	Human, Mouse, Rat	WB IHC	200ug	59670
CLSAF6495	IKK-gamma Antibody	48kDa	Human	WB IHC	200ug	59670
CLSAF6496	IKK-γ Antibody	43kDa	Human	WB IF/ICC	200ug	59670
CLSAF6497	Smad2 Antibody	52kDa	Human, Mouse, Rat	WB IHC IF/ICC	200ug	59670
CLSAF7001	Collagen I Antibody	kDa	Human, Mouse, Rat	WB IHC IF/ICC	200ug	59670
CLSAF7002	Cox1 Antibody	70kDa	Human Pig	WB IHC	200ug	59670
CLSAF7003	Cox2 Antibody	80kDa	Human, Mouse, Rat	WB IHC IF/ICC	200ug	59670
CLSAF7004	Cytochrome c Antibody	15kDa	Human, Mouse, Rat	WB IHC IF	200ug	59670
CLSAF7005	HDAC9 Antibody	110kDa	Human	WB IHC IF/ICC	200ug	59670
CLSAF7006	Nrf2 Antibody	68kDa	Human, Mouse, Rat	WB IHC IF/ICC	200ug	59670
CLSAF7007	TIMP1 Antibody	24kDa	Human, Mouse, Rat	WB	200ug	59670
CLSAF7008	TIMP2 Antibody	24kDa	Human, Mouse, Rat	WB IF/ICC	200ug	59670
CLSAF7009	TIMP4 Antibody	26kDa	Human, Mouse, Rat	WB IHC	200ug	59670
CLSAF7010	Tubulin alpha Antibody	50kDa	Human, Mouse, Rat	WB IHC IF/ICC	200ug	59670
CLSAF7011	Tubulin beta Antibody	55kDa	Human, Mouse, Rat	WB IHC	200ug	59670
CLSAF7012	Tubulin gamma Antibody	51kDa	Human, Mouse, Rat	WB IHC	200ug	59670
CLSAF7013	Vimentin Antibody	53kDa	Human, Mouse, Rat	WB IHC IF	200ug	59670
CLSAF7014	TNFA Antibody	kDa	Human, Mouse, Rat	WB IHC IF/ICC	200ug	59670
CLSAF7015	TFEB Antibody	52kDa	Human, Mouse	WB IHC	200ug	59670
CLSAF7016	ROCK1 Antibody	160kDa	Human, Mouse, Rat	WB	200ug	59670
CLSAF7017	TLR4 antibody	100kDa	Human, Mouse, Rat	WB IHC	200ug	59670
CLSAF7018	Beta actin antibody	43kDa	Human, Mouse, Rat	WB	200ug	59670
CLSAF7019	VEGFB antibody	21kDa	Human, Mouse, Rat	WB	200ug	59670
CLSAF7020	HMGB1 antibody	24kDa	Human, Mouse, Rat	WB	200ug	59670
CLSAF7021	GAPDH antibody	37kDa	Human, Mouse, Rat	WB	200ug	59670
CLSAF7022	Cleaved-caspase 3 antibody	17kDa	Human Mouse Rat	WB IHC	200ug	59670
CLSAF7023	Cleaved-PARP antibody	85,110kDa	Human, Mouse	WB	200ug	59670
CLSAF8001	Phospho-CDC2 (Thr161) Antibody	34kD	Human, Mouse, Rat	WB IHC	200ug	59670
CLSAF9103	Bcl-2 Mouse mAb	26 kd	Human, Mouse, Rat	WB IHC	200ug	59670
CLSBCD16	Neuroigin 1/2/3/4 Antibody	50-100 KD	Human, Mouse, Rat	WB	200ug	59670
CLSBF0001	PSAP antibody	58.1kDa	Human;	ELISA, WB, IHC, ICC, FCM	200ug	76570
CLSBF0002	SPP1 antibody	35.4kDa	Human;	ELISA, WB, IHC, ICC	200ug	76570
CLSBF0003	MESP2 antibody	41.8kDa	Human;	ELISA, WB	200ug	76570
CLSBF0004	SFTPC antibody	21kDa	Human;	ELISA, WB	200ug	76570
CLSBF0005	MMP2 antibody	73.8kDa	Human;	ELISA, WB	200ug	76570
CLSBF0006	MEF2C antibody	51.2kDa	Human; Mouse;	ELISA, WB, IHC, FCM	200ug	76570
CLSBF0007	CAMK4 antibody	58kDa	Human;	ELISA, WB, IHC, ICC, FCM	200ug	76570
CLSBF0008	ACLY antibody	125kDa	Human; Mouse; Monkey;	ELISA, WB, IHC, ICC, FCM	200ug	76570
CLSBF0009	DKK3 antibody	38.3kDa	Human;	ELISA, WB, IHC, FCM	200ug	76570
CLSBF0010	KEAP1 antibody	69.7kDa	Human;	ELISA, WB, IHC, FCM	200ug	76570
CLSBF0011	CDKN2A antibody	16.5kDa	Human;	ELISA, WB, IHC, FCM	200ug	76570
CLSBF0012	PPY antibody	10.4kDa	Human;	ELISA, WB, FCM	200ug	76570
CLSBF0013	ABC5 antibody	89.8kDa	Human;	ELISA, WB, IHC, ICC, FCM	200ug	76570
CLSBF0015	T antibody	47.4kDa	Human;	ELISA, WB, IHC, FCM	200ug	76570
CLSBF0017	CD59 antibody	14.2kDa	Human;	ELISA, WB, IHC, ICC, FCM	200ug	76570
CLSBF0018	TWIST1 antibody	21kDa	Human;	ELISA, WB	200ug	76570
CLSBF0019	human Splunc2 antibody	27kDa	Human;	ELISA, WB, FCM	200ug	76570
CLSBF0020	SCGB1A1 antibody	10kDa	Human;	ELISA, WB, FCM	200ug	76570
CLSBF0021	TRIP6 antibody	50.3kDa	Human;	ELISA, WB, FCM	200ug	76570
CLSBF0022	STAT5A antibody	90.6kDa	Human;	ELISA, WB, IHC, ICC, FCM	200ug	76570
CLSBF0023	LMO2 antibody	18.4kDa	Human;	ELISA, WB, FCM	200ug	76570
CLSBF0024	NEFH antibody	112.4kDa	Human;	ELISA, WB, IHC	200ug	76570
CLSBF0025	UTF1 antibody	36.4kDa	Human;	ELISA, WB, FCM	200ug	76570

Antibodies
HSN : 38220090

Cat#	Product Description	MW	Reactivity	Application	Pack Size	Unit Price
CLSBF0026	MARK3 antibody	87kDa	Human; Mouse;	ELISA, WB, IHC, FCM	200ug	76570
CLSBF0027	PIK3R1 antibody	83.6kDa	Human; Mouse;	ELISA, WB, FCM	200ug	76570
CLSBF0028	FOXP1 antibody	75.3kDa	Human;	ELISA, WB, IHC, FCM	200ug	76570
CLSBF0029	AICAM antibody	65.1kDa	Human;	ELISA, WB, IHC	200ug	76570
CLSBF0030	ILK antibody	51.4kDa	Human; Mouse; Monkey;	ELISA, WB, IHC, FCM	200ug	76570
CLSBF0031	CD5 antibody	54.6kDa	Human;	ELISA, WB, FCM	200ug	76570
CLSBF0032	PTPN11 antibody	68.4kDa	Human;	ELISA, WB, IHC, ICC, FCM	200ug	76570
CLSBF0033	PAX5 antibody	45kDa	Human;	ELISA, WB, IHC	200ug	76570
CLSBF0034	HAS2 antibody	63.5kDa	Human;	ELISA, WB, IHC, ICC	200ug	76570
CLSBF0036	FZD5 antibody	64.5kDa	Human;	ELISA, WB, FCM	200ug	76570
CLSBF0037	SRY antibody	23.9kDa	Human;	ELISA, WB, IHC, FCM	200ug	76570
CLSBF0038	RAG1 antibody	119kDa	Human;	ELISA, WB	200ug	76570
CLSBF0039	IGF2 antibody	20.1kDa	Human;	ELISA, WB, IHC, ICC, FCM	200ug	76570
CLSBF0040	TWF1 antibody	40.3kDa	Human;	ELISA, WB, IHC, ICC, FCM	200ug	76570
CLSBF0041	ENO2 antibody	47.3kDa	Human; Mouse	ELISA, WB, IHC, FCM	200ug	76570
CLSBF0042	SST antibody	12.7kDa	Human;	ELISA, WB, IHC, FCM	200ug	76570
CLSBF0043	POU3F2 antibody	46.9kDa	Human;	ELISA, WB	200ug	76570
CLSBF0044	CD6 antibody	71.8kDa	Human;	ELISA, WB, IHC	200ug	76570
CLSBF0045	PLK1 antibody	68kDa	Human; Mouse;	ELISA, WB, IHC, FCM	200ug	76570
CLSBF0046	ANXA1 antibody	38.7kDa	Human; Mouse; Monkey;	ELISA, WB, IHC	200ug	76570
CLSBF0048	CSNK2A2 antibody	41.2kDa	Human; Mouse;	ELISA, WB, FCM	200ug	76570
CLSBF0049	NR6A1 antibody	54.3kDa	Human	ELISA, WB, IHC, ICC, FCM	200ug	76570
CLSBF0050	SPIB antibody	28.8kDa	Human; Mouse;	ELISA, WB, IHC, ICC, FCM	200ug	76570
CLSBF0051	KRT13 antibody	52kDa	Human	ELISA, WB, FCM	200ug	76570
CLSBF0052	PRKACG antibody	40.4kDa	Human	ELISA, WB, IHC, FCM	200ug	76570
CLSBF0053	CDK2 antibody	33.9kDa	Human; Mouse	ELISA, WB, IHC, ICC, FCM	200ug	76570
CLSBF0054	SKP1 antibody	19kDa	Human	ELISA, WB, IHC, FCM	200ug	76570
CLSBF0055	MAP2K7 antibody	48kDa	Human	ELISA, WB, IHC, ICC, FCM	200ug	76570
CLSBF0056	CCT2 antibody	54kDa	Human	ELISA, WB	200ug	76570
CLSBF0057	PINCH antibody	37kDa	Human	ELISA, WB, ICC, FCM	200ug	76570
CLSBF0058	ABCG2 antibody	72kDa	Human; Mouse; Monkey	ELISA, WB, IHC, ICC, FCM	200ug	76570
CLSBF0059	LHX2 antibody	44kDa	Human	ELISA, WB, ICC	200ug	76570
CLSBF0060	MAP2K6 antibody	38kDa	Human; Mouse	ELISA, WB, IHC	200ug	76570
CLSBF0061	FOXD3 antibody	50kDa	Human; Mouse; Monkey	ELISA, WB, IHC	200ug	76570
CLSBF0062	CENB1 antibody	60kDa	Human	ELISA, WB, IHC	200ug	76570
CLSBF0063	RICTOR antibody	192kDa	Human; Monkey; Mouse	ELISA, WB, IHC, ICC, FCM	200ug	76570
CLSBF0064	KLHL25 antibody	65kDa	Human	ELISA, WB	200ug	76570
CLSBF0065	CDC2 antibody	34kDa	Human	ELISA, WB, ICC, FCM	200ug	76570
CLSBF0066	EGF antibody	134kDa	Human	ELISA, WB, ICC	200ug	76570
CLSBF0067	TLR2 antibody	100kDa	Human	ELISA, WB	200ug	76570
CLSBF0068	KDR antibody	152kDa	Human	ELISA, WB, ICC, FCM	200ug	76570
CLSBF0069	AGT antibody	53kDa	Human	ELISA, WB	200ug	76570
CLSBF0070	EPHB4 antibody	108kDa	Human	ELISA, WB, ICC	200ug	76570
CLSBF0071	Vimentin antibody	54kDa	Human; Monkey	ELISA, WB, IHC	200ug	76570
CLSBF0072	NCOA3 antibody	155kDa	Human	ELISA, WB	200ug	76570
CLSBF0073	MLH1 antibody	85kDa	Human; Monkey	ELISA, WB, IHC, ICC	200ug	76570
CLSBF0074	SYK antibody	72kDa	Human	ELISA, WB	200ug	76570
CLSBF0075	HPS1 antibody	79kDa	Human	ELISA, WB	200ug	76570
CLSBF0076	FER antibody	95kDa	Human; Mouse	ELISA, WB, IHC, ICC	200ug	76570
CLSBF0077	HER-2 antibody	138kDa	Human	ELISA, WB, IHC	200ug	76570
CLSBF0078	Desmin antibody	53kDa	Human	ELISA, WB, IHC	200ug	76570
CLSBF0079	LAL antibody	46kDa	Human	ELISA, WB	200ug	76570
CLSBF0080	MCL-1 antibody	37kDa	Human	ELISA, WB, IHC, ICC	200ug	76570
CLSBF0083	DCX antibody	49.3kDa	Human	ELISA, WB, IHC, ICC, FCM	200ug	76570
CLSBF0084	HSP90AA1 antibody	90kDa	Human; Mouse; Monkey	ELISA, WB, IHC, FCM	200ug	76570
CLSBF0086	SERPINE1 antibody	45kDa	Human	ELISA, WB, IHC, FCM	200ug	76570
CLSBF0087	UBE21 antibody	18kDa	Human; Monkey	ELISA, WB, IHC, ICC, FCM	200ug	76570
CLSBF0088	CRK antibody	42kDa	Human	ELISA, WB, IHC, ICC, FCM	200ug	76570
CLSBF0089	CRKL antibody	39kDa	Human	ELISA, WB, FCM	200ug	76570
CLSBF0090	PODXL antibody	49kDa	Human	ELISA, WB, IHC, FCM	200ug	76570
CLSBF0091	CDK1 antibody	34kDa	Human; Mouse; Rat; Monkey	ELISA, WB, IHC, ICC	200ug	76570

Antibodies
HSN : 38220090

Cat#	Product Description	MW	Reactivity	Application	Pack Size	Unit Price
CLSBF0092	CEA antibody	77kDa	Human	ELISA, WB, ICC	200ug	76570
CLSBF0093	SETDB1 antibody	180kDa	Human; Mouse; Monkey	ELISA, WB	200ug	76570
CLSBF0094	CHUK antibody	85kDa	Human	ELISA, WB, ICC, FCM	200ug	76570
CLSBF0095	HAS1 antibody	65kDa	Human	ELISA, WB, ICC	200ug	76570
CLSBF0096	ETV5 antibody	58kDa	Human	ELISA, WB	200ug	76570
CLSBF0097	ICAM1 antibody	57.8kDa	Human	ELISA, WB	200ug	76570
CLSBF0098	Pirh2 antibody	30kDa; 60kDa (homodimer)	Human; Rat	ELISA, WB, IHC, ICC, FCM	200ug	76570
CLSBF0100	TEC antibody	74kDa	Human	ELISA, WB	200ug	76570
CLSBF0101	AAT antibody	47kDa	Human; Mouse	ELISA, WB	200ug	76570
CLSBF0102	MYL2 antibody	19kDa	Human	ELISA, WB	200ug	76570
CLSBF0104	CD33 antibody	39kDa	Human	ELISA, WB	200ug	76570
CLSBF0106	Glucose-6-phosphate isomerase antibody	63kDa	Human	ELISA, WB, IHC, ICC	200ug	76570
CLSBF0107	STYK1 antibody	47kDa	Human	ELISA, WB, IHC	200ug	76570
CLSBF0108	Cytokeratin 5 antibody	62kDa	Human	ELISA, WB, IHC	200ug	76570
CLSBF0109	ApoM antibody	21kDa	Human	ELISA, WB, ICC	200ug	76570
CLSBF0110	SNCG (breast cancer-specific protein 1) antibody	13kDa	Human	ELISA, WB, IHC	200ug	76570
CLSBF0111	ER-alpha antibody	68kDa	Human	ELISA, WB, IHC	200ug	76570
CLSBF0115	FOS antibody	40.7kDa	Human	ELISA, WB, IHC, FCM	200ug	76570
CLSBF0116	CRP antibody	25kDa	Human	ELISA, WB, IHC, FCM	200ug	76570
CLSBF0117	NEFL antibody	62kDa	Human	ELISA, WB, IHC, ICC, FCM	200ug	76570
CLSBF0118	BMI1 antibody	37kDa	Human;	ELISA, WB, IHC, ICC, FCM	200ug	76570
CLSBF0119	MCM2 antibody	125kDa	Human; Mouse; Rat; Monkey	ELISA, WB, IHC, FCM	200ug	76570
CLSBF0120	alpha SMA antibody	42kDa	Human; Mouse; Rat; Monkey	ELISA, WB, IHC, ICC, FCM	200ug	76570
CLSBF0121	CDK5 antibody	35kDa	Human; Rat; Monkey	ELISA, WB, IHC, ICC, FCM	200ug	76570
CLSBF0122	CD1A antibody	37kDa	Human	ELISA, WB, FCM	200ug	76570
CLSBF0123	AURKA antibody	48kDa	Human; Monkey; Rat	ELISA, WB, ICC, FCM	200ug	76570
CLSBF0124	BLK antibody	58kDa	Human	ELISA, WB, ICC, FCM	200ug	76570
CLSBF0125	KLHL1 antibody	82kDa	Human	ELISA, WB, ICC	200ug	76570
CLSBF0126	HK1 antibody	102kDa	Human; Rat; Mouse	ELISA, WB, IHC, ICC	200ug	76570
CLSBF0127	CCND1 antibody	33.7kDa	Human	ELISA, WB	200ug	76570
CLSBF0128	CLOCK antibody	95kDa	Human	ELISA, WB, ICC	200ug	76570
CLSBF0129	MAP2K2 antibody	44kDa	Human; Mouse; Rat	ELISA, WB, ICC, FCM	200ug	76570
CLSBF0130	TBL1X antibody	62.4kDa	Human; Monkey	ELISA, WB	200ug	76570
CLSBF0131	FLT1 antibody	100kDa	Human	ELISA, WB	200ug	76570
CLSBF0132	Ki67 antibody	358kDa	Human	ELISA, IHC	200ug	76570
CLSBF0133	FGFR4 antibody	87.9kDa	Human	ELISA, WB, ICC	200ug	76570
CLSBF0134	PEG10 antibody	80kDa	Human	ELISA, WB, IHC, ICC	200ug	76570
CLSBF0135	PGR antibody	99kDa	Human	ELISA, WB	200ug	76570
CLSBF0136	FRK antibody	56kDa	Human	ELISA, WB, IHC	200ug	76570
CLSBF0137	IGFBP2 antibody	35kDa.	Human	ELISA, WB, IHC	200ug	76570
CLSBF0138	PSA (KLK3) antibody	68kDa	Human	ELISA, WB, IHC, FCM	200ug	76570
CLSBF0139	FES antibody	93kDa	Human;	ELISA, WB, IHC	200ug	76570
CLSBF0140	S100A10/P11 antibody	11kDa	Human	ELISA, WB, IHC, ICC	200ug	76570
CLSBF0141	CK1 antibody	39kDa	Human	ELISA, WB, IHC	200ug	76570
CLSBF0146	SHH antibody	49.6kDa	Human; Mouse; Monkey	ELISA, WB, IHC, FCM	200ug	76570
CLSBF0147	HSF4 antibody	53kDa	Human	ELISA, WB, FCM	200ug	76570
CLSBF0148	RAF1 antibody	72kDa	Human	ELISA, WB, IHC, FCM	200ug	76570
CLSBF0149	TNNI2 antibody	21kDa	Human	ELISA, WB, ICC, FCM	200ug	76570
CLSBF0150	KID antibody	73kDa	Human	ELISA, WB, IHC	200ug	76570
CLSBF0151	C-CBL antibody	120kDa	Human; Mouse; Rat	ELISA, WB, IHC, ICC, FCM	200ug	76570
CLSBF0152	MAP3K5 antibody	55kDa	Human	ELISA, WB, IHC, ICC, FCM	200ug	76570
CLSBF0153	CREB1 antibody	43kDa	Human; Mouse; Rat; Monkey	ELISA, WB, IHC, ICC	200ug	76570
CLSBF0154	CD94 antibody	21kDa	Human	ELISA, WB	200ug	76570
CLSBF0155	SMAD5 antibody	52kDa	Human; Rat	ELISA, WB, IHC, ICC, FCM	200ug	76570
CLSBF0156	TNFRSF11B antibody	60kDa	Human	ELISA, WB, ICC, FCM	200ug	76570
CLSBF0158	STAT5B antibody	90kDa	Human	ELISA, WB	200ug	76570
CLSBF0159	EPCAM antibody	35kDa	Human	ELISA, WB, IHC	200ug	76570
CLSBF0160	PTH antibody	12.9kDa	Human	ELISA, WB	200ug	76570
CLSBF0161	PP32 antibody	28kDa	Human	ELISA, WB, IHC	200ug	76570
CLSBF0162	DDX4 antibody	76kDa	Human	ELISA, WB, IHC, ICC, FCM	200ug	76570
CLSBF0163	Proteinase 3 antibody	28kDa	Human	ELISA, WB	200ug	76570
CLSBF0164	ISL1 antibody	39kDa	Human	ELISA, WB, IHC, ICC	200ug	76570

Antibodies
HSN : 38220090

Cat#	Product Description	MW	Reactivity	Application	Pack Size	Unit Price
CLSBF0165	FGR antibody	56kDa	Human,Mouse	ELISA, WB, IHC	200ug	76570
CLSBF0166	BHMT antibody	45kDa	Human	ELISA, WB, IHC	200ug	76570
CLSBF0167	CD10 antibody	85kDa	Human	ELISA, WB, IHC	200ug	76570
CLSBF0169	FBLN2 antibody	127kDa	Human	ELISA, WB	200ug	76570
CLSBF0170	TNF-alpha antibody	17.4kDa	Human	ELISA, WB	200ug	76570
CLSBF0171	RSK1 antibody	90kDa	Human	ELISA, WB, IHC	200ug	76570
CLSBF0172	INHA (Inhibin alpha) antibody	40kDa	Human	ELISA, IHC, ICC	200ug	76570
CLSBF0173	TGF beta1 antibody	45kDa	Human	ELISA, WB	200ug	76570
CLSBF0174	CD4 antibody	51kDa	Human	ELISA	200ug	76570
CLSBF0175	IL-10 antibody	21kDa	Human	ELISA, WB	200ug	76570
CLSBF0177	ARHGDI A antibody	26kDa	Human; Mouse; Monkey	ELISA, WB, ICC, FCM	200ug	76570
CLSBF0178	NCK1 antibody	47kDa	Human; Monkey	ELISA, WB, IHC, FCM	200ug	76570
CLSBF0179	ALPL antibody	57.3kDa	Human	ELISA, WB, IHC, FCM	200ug	76570
CLSBF0180	CYP1A1 antibody	58kDa	Human	ELISA, WB, IHC	200ug	76570
CLSBF0181	G6PD antibody	59kDa	Human	ELISA, WB, IHC, FCM	200ug	76570
CLSBF0182	GATA5 antibody	41kDa	Human	ELISA, WB	200ug	76570
CLSBF0183	XRCC5 antibody	86kDa	Human; Mouse	ELISA, WB, IHC, ICC, FCM	200ug	76570
CLSBF0184	CDK9 antibody	43kDa	Human	ELISA, WB, IHC	200ug	76570
CLSBF0187	NACC1 antibody	58kDa	Human	ELISA, WB, IHC	200ug	76570
CLSBF0188	ERBB2 antibody	180kDa	Human	ELISA, WB, IHC, FCM	200ug	76570
CLSBF0189	SIRT1 antibody	120kDa	Human; Monkey Rat	ELISA, WB, IHC, ICC, FCM	200ug	76570
CLSBF0190	ALPP antibody	58kDa	Human	ELISA, WB, IHC	200ug	76570
CLSBF0191	CD3E antibody	23kDa	Human	ELISA, WB, FCM	200ug	76570
CLSBF0193	GTF2B antibody	34.8kDa	Human; Monkey	ELISA, WB	200ug	76570
CLSBF0194	DAXX antibody	81kDa	Human	ELISA, WB, ICC, FCM	200ug	76570
CLSBF0195	PAK2 antibody	61kDa	Human; Monkey	ELISA, WB, IHC, ICC	200ug	76570
CLSBF0196	WNT5A antibody	42.3kDa	Human	ELISA, WB, IHC, ICC	200ug	76570
CLSBF0197	Cytokeratin 19 antibody	44kDa	Human	ELISA, WB	200ug	76570
CLSBF0198	beta-Actin antibody	43KD	Human; Mouse; Hamster; Rat; Monkey	ELISA, WB, ICC, FCM	200ug	76570
CLSBF0200	ESR1 antibody	68kDa	Human	ELISA, WB	200ug	76570
CLSBF0201	Survivin antibody	16kDa	Human	ELISA, WB	200ug	76570
CLSBF0203	PTK6 antibody	52kDa	Human	ELISA, WB	200ug	76570
CLSBF0205	HPRT antibody	25kDa	Human	ELISA, WB	200ug	76570
CLSBF0206	Trim5alpha antibody	56kDa	Human	ELISA, WB, IHC	200ug	76570
CLSBF0209	MAP2 antibody	199kDa	Human	ELISA, WB, FCM	200ug	76570
CLSBF0210	THPO antibody	37.8kDa	Human	ELISA, WB, FCM	200ug	76570
CLSBF0211	FOXO1 antibody	69.7kDa	Human; Mouse	ELISA, WB, IHC, ICC	200ug	76570
CLSBF0212	LPlunc1 antibody	52kDa	Human	ELISA, WB, IHC, ICC, FCM	200ug	76570
CLSBF0214	PRK2 antibody	140kDa	Human; Monkey; Mouse; Rat	ELISA, WB, IHC, FCM	200ug	76570
CLSBF0215	HSP90AB1 antibody	84kDa	Human; Mouse; Rat; Monkey	ELISA, WB, IHC, ICC, FCM	200ug	76570
CLSBF0216	BPTF antibody	338kDa	Human	ELISA, WB	200ug	76570
CLSBF0217	MSI1 antibody	39kDa	Human	ELISA, WB, FCM	200ug	76570
CLSBF0218	PSIP1 antibody	75kDa	Human; Monkey; Rat	ELISA, WB, IHC, ICC	200ug	76570
CLSBF0219	CDH1 antibody	135kDa	Human; Mouse; Monkey	ELISA, WB	200ug	76570
CLSBF0220	ALDH1A1 antibody	55kDa	Human	ELISA, WB, IHC	200ug	76570
CLSBF0221	ZBTB16 antibody	74kDa	Human	ELISA, WB, ICC	200ug	76570
CLSBF0222	NME1 antibody	17kDa	Human	ELISA, WB, IHC, ICC, FCM	200ug	76570
CLSBF0223	ERN1 antibody	109kDa	Human	ELISA, WB, IHC	200ug	76570
CLSBF0224	ATP2C1 antibody	100kDa	Human; Monkey	ELISA, WB, IHC	200ug	76570
CLSBF0225	KRT15 antibody	49kDa	Human	ELISA, WB, IHC, ICC, FCM	200ug	76570
CLSBF0226	FOXA2 antibody	48kDa	Human	ELISA, WB, IHC	200ug	76570
CLSBF0227	CD18 antibody	85kDa	Human, Mouse	ELISA, ICC	200ug	76570
CLSBF0228	CD37 antibody	31.7kDa	Human, Mouse	ELISA, ICC	200ug	76570
CLSBF0229	LAMB1 antibody	198kDa	Human	ELISA, WB, IHC	200ug	76570
CLSBF0230	HDAC3 antibody	48.8kDa	Human	ELISA, WB, ICC	200ug	76570
CLSBF0231	PPARG antibody	58kDa	Human	ELISA, WB	200ug	76570
CLSBF0232	MSH6 antibody	153kDa	Human	ELISA, WB	200ug	76570
CLSBF0233	CD20 antibody	33kDa	Human	ELISA, IHC, ICC	200ug	76570
CLSBF0234	IGF1R-Beta antibody	96kDa	Human;	ELISA, WB, IHC	200ug	76570
CLSBF0235	BRAF antibody	84.4kDa	Human	ELISA, WB, IHC	200ug	76570
CLSBF0236	Akt3 antibody	55kDa	Human	ELISA, WB	200ug	76570
CLSBF0238	IL-8 antibody	11.1kDa	Human	ELISA, WB	200ug	76570
CLSBF0240	KLK3 antibody	29kDa	Human	ELISA, WB, FCM	200ug	76570
CLSBF0241	CYP3A4 antibody	57.3kDa	Human	ELISA, WB, IHC, ICC, FCM	200ug	76570

Antibodies
HSN : 38220090

Cat#	Product Description	MW	Reactivity	Application	Pack Size	Unit Price
CLSBF0242	ASS1 antibody	47kDa	Human; Mouse; Monkey	ELISA, WB, IHC	200ug	76570
CLSBF0243	GSTM1 antibody	26kDa	Human; Rat	ELISA, WB, IHC, FCM	200ug	76570
CLSBF0244	FGG antibody	52kDa	Human	ELISA, WB, IHC, ICC, FCM	200ug	76570
CLSBF0245	c-Jun antibody	43kDa	Human; Mouse; Monkey	ELISA, WB, IHC, ICC, FCM	200ug	76570
CLSBF0246	CD105 antibody	71kDa	Human	ELISA, WB, IHC, ICC, FCM	200ug	76570
CLSBF0247	RBP4 antibody	23kDa	Human	ELISA, WB, IHC, ICC, FCM	200ug	76570
CLSBF0249	ATXN1 antibody	87kDa	Human	ELISA, WB, IHC, ICC, FCM	200ug	76570
CLSBF0251	COX4I1 antibody	19kDa	Human; Monkey; Rat; Mouse	ELISA, WB, ICC, FCM	200ug	76570
CLSBF0252	KLHL11 antibody	80kDa	Human	ELISA, WB, IHC, ICC	200ug	76570
CLSBF0253	VCAM1 antibody	81kDa	Human	ELISA, WB, IHC	200ug	76570
CLSBF0254	PRDM1 antibody	88kDa	Human; Mouse	ELISA, WB	200ug	76570
CLSBF0255	ABL2 antibody	128kDa	Human; Mouse	ELISA, WB, ICC	200ug	76570
CLSBF0256	JAK3 antibody	125kDa	Human; Mouse	ELISA, WB, ICC, FCM	200ug	76570
CLSBF0257	ERBB3 antibody	148kDa	Human	ELISA, WB, ICC	200ug	76570
CLSBF0259	Myostatin antibody	42.7kDa	Human	ELISA, WB	200ug	76570
CLSBF0260	ETV1 antibody	55kDa	Human	ELISA, WB	200ug	76570
CLSBF0261	HAND1 antibody	24kDa	Human	ELISA, WB	200ug	76570
CLSBF0263	YES1 antibody	61kDa	Human	ELISA, WB	200ug	76570
CLSBF0264	BNP antibody	15kDa	Human	ELISA, IHC	200ug	76570
CLSBF0265	BTK antibody	77kDa	Human; Monkey	ELISA, WB, IHC, ICC	200ug	76570
CLSBF0266	ELK1 antibody	45kDa	Human	ELISA, WB	200ug	76570
CLSBF0267	Dynamin-1 antibody	97kDa	Human	ELISA, WB, IHC	200ug	76570
CLSBF0271	SPI1 antibody	42kDa	Human	ELISA, WB, FCM	200ug	76570
CLSBF0273	FN1 antibody	262.6kDa	Human	ELISA, WB, IHC, FCM	200ug	76570
CLSBF0274	NEDD8 antibody	9kDa	Human	ELISA, WB, IHC, ICC, FCM	200ug	76570
CLSBF0276	PHB antibody	30kDa	Human; Mouse; Rat; Monkey	ELISA, WB, IHC, ICC, FCM	200ug	76570
CLSBF0277	CD15 antibody	59kDa	Human	ELISA, IHC, ICC	200ug	76570
CLSBF0278	ApoB antibody	516kDa	Human	ELISA, WB, ICC, FCM	200ug	76570
CLSBF0279	EIF4E antibody	25kDa	Human	ELISA, WB, IHC, ICC, FCM	200ug	76570
CLSBF0280	ATF2 antibody	55kDa	Human; Mouse	ELISA, WB, IHC	200ug	76570
CLSBF0281	STK11 antibody	54kDa	Human; Mouse; Monkey	ELISA, WB, FCM	200ug	76570
CLSBF0282	MATN1 antibody	54kDa	Human	ELISA, WB, ICC	200ug	76570
CLSBF0283	HK2 antibody	102kDa	Human	ELISA, WB, IHC, FCM	200ug	76570
CLSBF0284	KLHL21 antibody	66kDa	Human	ELISA, WB, IHC	200ug	76570
CLSBF0286	CK7 antibody	51kDa	Human	ELISA, WB, FCM	200ug	76570
CLSBF0287	CHD3 antibody	226kDa	Human; Mouse	ELISA, WB, IHC, ICC, FCM	200ug	76570
CLSBF0288	CER1 antibody	30kDa	Human	ELISA, WB, IHC	200ug	76570
CLSBF0289	PDGFRbeta antibody	190kDa	Human; Mouse	ELISA, WB	200ug	76570
CLSBF0290	AXL antibody	97.4kDa	Human	ELISA, WB, ICC	200ug	76570
CLSBF0291	Mammaglobin-1 antibody	11kDa	Human	ELISA, WB	200ug	76570
CLSBF0293	DDR1 antibody	101kDa	Human	ELISA, WB	200ug	76570
CLSBF0294	Tyro3 antibody	96kDa	Human	ELISA, ICC	200ug	76570
CLSBF0295	LPP antibody	66kDa	Human; Mouse; Monkey; Hamster	ELISA, WB, IHC, ICC	200ug	76570
CLSBF0296	SORL1 antibody	246kDa	Human	ELISA, WB, IHC, ICC	200ug	76570
CLSBF0298	ERK2 antibody	41kDa	Human; Mouse; Monkey	ELISA, WB, IHC, ICC	200ug	76570
CLSBF0299	FGF2 antibody	31kDa	Human	ELISA, WB, IHC	200ug	76570
CLSBF0300	MSH2 antibody	105kDa	Human; Monkey	ELISA, WB, IHC, ICC	200ug	76570
CLSBF0304	RAP1A antibody	21kDa	Human	ELISA, WB, FCM	200ug	76570
CLSBF0305	PBK antibody	36kDa	human	ELISA, WB, IHC, ICC, FCM	200ug	76570
CLSBF0306	ROCK1 antibody	158kDa	Human	ELISA, WB	200ug	76570
CLSBF0307	CASP8 antibody	26kDa	Human; Mouse; Monkey; Rat	ELISA, WB, IHC, FCM	200ug	76570
CLSBF0309	FYN antibody	61kDa	Human	ELISA, WB, IHC, ICC, FCM	200ug	76570
CLSBF0310	MTHFR antibody	75kDa	Human; Rat	ELISA, WB, IHC	200ug	76570
CLSBF0311	E7 antibody	21kDa	Human	ELISA, WB, IHC	200ug	76570
CLSBF0312	PDK1 antibody	44kDa	Human; Monkey; Rat	ELISA, WB, IHC, ICC, FCM	200ug	76570
CLSBF0313	IGF2BP3 antibody	69kDa	Human	ELISA, WB, IHC	200ug	76570
CLSBF0314	MYOD1 antibody	34kDa	Human	ELISA, WB	200ug	76570
CLSBF0315	PTK7 antibody	118kDa	Human	ELISA, WB, IHC	200ug	76570
CLSBF0316	FAK antibody	119kDa	Human	ELISA, WB, ICC, FCM	200ug	76570
CLSBF0317	HSPA5 antibody	78kDa	Human	ELISA, WB, IHC	200ug	76570

Antibodies
HSN : 38220090

Cat#	Product Description	MW	Reactivity	Application	Pack Size	Unit Price
CLSBF0318	BDH1 antibody	38kDa	Human; Mouse	ELISA, WB, IHC	200ug	76570
CLSBF0319	CTNNB1 antibody	85kDa	Human	ELISA, WB, IHC, ICC, FCM	200ug	76570
CLSBF0320	WNT1 antibody	41kDa	Human; Mouse	ELISA, WB, IHC, ICC, FCM	200ug	76570
CLSBF0321	FGB antibody	52kDa	Human	ELISA, WB	200ug	76570
CLSBF0323	NANOG antibody	35kDa	Human	ELISA, WB, ICC	200ug	76570
CLSBF0324	EP300 antibody	300kDa	Human	ELISA, WB	200ug	76570
CLSBF0325	GABPA antibody	51kDa	Human; Mouse	ELISA, WB, ICC	200ug	76570
CLSBF0326	EphB3 antibody	110kDa	Human	ELISA, WB, IHC	200ug	76570
CLSBF0327	MAPK11 antibody	42kDa	Human	ELISA, WB	200ug	76570
CLSBF0328	MYST1 antibody	53kDa	Human	ELISA, WB, IHC, ICC	200ug	76570
CLSBF0329	IKKB antibody	87kDa	Human	ELISA, WB, IHC	200ug	76570
CLSBF0330	Fibulin 5 antibody	50kDa.	Human	ELISA, WB	200ug	76570
CLSBF0334	TGFb1 antibody	44.3kDa	Human	ELISA, WB, IHC, FCM	200ug	76570
CLSBF0335	GAB1 antibody	76.6kDa	Human	ELISA, WB, IHC, FCM	200ug	76570
CLSBF0336	ITGB1 antibody	88.4kDa	Human Mouse	ELISA, WB, IHC, FCM	200ug	76570
CLSBF0337	PPP2R4 antibody	41kDa	Human	ELISA, WB, IHC, ICC, FCM	200ug	76570
CLSBF0339	CEBPB antibody	36kDa	Human	ELISA, WB, FCM	200ug	76570
CLSBF0340	GRIA3 antibody	101kDa	Human	ELISA, WB, IHC	200ug	76570
CLSBF0341	Epha10 antibody	110kDa	Human	ELISA, WB	200ug	76570
CLSBF0342	BMPR2 antibody	115kDa	Human; Mouse; Rat; Monkey	ELISA, WB, IHC	200ug	76570
CLSBF0343	NR3C1 antibody	86kDa	Human	ELISA, WB, IHC, ICC, FCM	200ug	76570
CLSBF0344	KDM3A antibody	147kDa	Human	ELISA, WB, IHC	200ug	76570
CLSBF0345	GFAP antibody	50kDa	Human	ELISA, WB, IHC, ICC	200ug	76570
CLSBF0346	NFKBIB antibody	45kDa	Human	ELISA, WB	200ug	76570
CLSBF0348	SYN antibody	33.8kDa	Human; Rat	ELISA, WB, IHC	200ug	76570
CLSBF0349	Androgen receptor antibody	110kDa	Human	ELISA, WB, IHC	200ug	76570
CLSBF0350	FABP2 antibody	15kDa	Human	ELISA, WB, IHC, ICC, FCM	200ug	76570
CLSBF0351	NTRK3 antibody	94kDa	Human	ELISA, WB	200ug	76570
CLSBF0352	MPS1 antibody	95kDa	Human	ELISA, ICC	200ug	76570
CLSBF0354	STAT3 antibody	88kDa	Human, Mouse, Rat	ELISA, WB, IHC, IF	200ug	76570
CLSBF0355	EphA8 antibody	111kDa.	Human	ELISA, WB	200ug	76570
CLSBF0356	MAP4K4 antibody	142kDa	Human	ELISA, WB	200ug	76570
CLSBF0357	SRC antibody	60kDa	Human	ELISA, WB	200ug	76570
CLSBF0362	cTnI antibody	18kDa.	Human	ELISA, WB, IHC	200ug	76570
CLSBF0366	DLL4 antibody	74.6kDa	Human	ELISA, WB, FCM	200ug	76570
CLSBF0367	RPA1 antibody	68.1kDa	Human; Monkey	ELISA, WB, IHC, ICC, FCM	200ug	76570
CLSBF0368	YAP1 antibody	54.4kDa	Human	ELISA, WB, IHC, FCM	200ug	76570
CLSBF0369	CD9 antibody	25kDa	Human	ELISA, WB, IHC, FCM	200ug	76570
CLSBF0370	MAP3K2 antibody	70kDa	Human	ELISA, WB, ICC	200ug	76570
CLSBF0371	IRAK4 antibody	52kDa	Human; Mouse; Monkey	ELISA, WB, IHC, FCM	200ug	76570
CLSBF0372	c-Rel antibody	78kDa	Human; Mouse	ELISA, WB, IHC, ICC	200ug	76570
CLSBF0373	BID antibody	22kDa	Human	ELISA, WB, IHC, ICC, FCM	200ug	76570
CLSBF0374	ATM antibody	351kDa	Human	ELISA, WB	200ug	76570
CLSBF0375	CA9 antibody	50kDa	Human	ELISA, WB, IHC, FCM	200ug	76570
CLSBF0376	TAB2 antibody	80kDa	Human	ELISA, WB, FCM	200ug	76570
CLSBF0377	GFI1 antibody	45kDa	Human	ELISA, WB	200ug	76570
CLSBF0378	SMAD3 antibody	48kDa	Human; Mouse	ELISA, WB, ICC	200ug	76570
CLSBF0379	GATA1 antibody	42.7kDa	Human	ELISA, WB, IHC, ICC	200ug	76570
CLSBF0380	CDC25C antibody	58kDa	Human	ELISA, WB, IHC	200ug	76570
CLSBF0382	NF-kB p65 antibody	65kDa	Human; Mouse	ELISA, WB	200ug	76570
CLSBF0383	RTN3 antibody	113kDa	Human	ELISA, ICC	200ug	76570
CLSBF0384	MYL3 antibody	22kDa	Human	ELISA, WB, IHC	200ug	76570
CLSBF0385	IL-2 antibody	17.6kDa	Human	ELISA, WB	200ug	76570
CLSBF0388	TNK1 antibody	73kDa	Human	ELISA, WB	200ug	76570
CLSBF0389	PBEF1 antibody	56kDa	Human	ELISA, WB	200ug	76570
CLSBF0390	RET antibody	51kDa.	Human	ELISA, WB	200ug	76570
CLSBF0391	GSK3 alpha antibody	51kDa	Human	ELISA, WB	200ug	76570
CLSBF0392	4E-BP1 antibody	12kDa	Human	ELISA, WB, IHC	200ug	76570
CLSBF0393	SRA antibody	36kDa.	Human	ELISA, WB, IHC	200ug	76570
CLSBF0394	KSHV ORF26 antibody	N/A	Human	ELISA, WB	200ug	76570
CLSBF0395	IFN-gamma antibody	19kDa	Human	ELISA, WB	200ug	76570
CLSBF0397	VAV1 antibody	98.3kDa	Human	ELISA, WB, FCM	200ug	76570
CLSBF0398	EIF4B antibody	80kDa	Human; Mouse	ELISA, WB, ICC, FCM	200ug	76570
CLSBF0402	PGC-1alpha antibody	91kDa	Human	ELISA, WB	200ug	76570

Antibodies
HSN : 38220090

Cat#	Product Description	MW	Reactivity	Application	Pack Size	Unit Price
CLSBF0403	CD133 antibody	133kDa	Human	ELISA, IHC, FCM	200ug	76570
CLSBF0404	ApoE antibody	36kDa	Human	ELISA, WB, IHC, FCM	200ug	76570
CLSBF0405	EEF2 antibody	95kDa	Human	ELISA, WB, IHC, ICC	200ug	76570
CLSBF0407	SLC22A1 antibody	61.2kDa	Human	ELISA, WB, FCM	200ug	76570
CLSBF0408	EIF2AK3 antibody	125kDa	Human	ELISA, WB	200ug	76570
CLSBF0410	CDC27 antibody	91kDa	Human	ELISA, WB, IHC	200ug	76570
CLSBF0411	CD19 antibody	61kDa	Human	ELISA, ICC, FCM	200ug	76570
CLSBF0412	p44/42 MAPK (Erk1/2) antibody	42kDa	Human; Mouse	ELISA, WB, IHC, FCM	200ug	76570
CLSBF0413	HDAC4 antibody	119kDa	Human	ELISA, WB	200ug	76570
CLSBF0415	FGFR1 antibody	92kDa	Human	ELISA, WB	200ug	76570
CLSBF0417	Myeloperoxidase antibody	84kDa	Human	ELISA, WB	200ug	76570
CLSBF0418	AR antibody	99kDa	Human	ELISA, WB	200ug	76570
CLSBF0419	ABL1 antibody	122kDa	Human	ELISA, WB	200ug	76570
CLSBF0421	MLL antibody	180kDa	Human	ELISA, WB, IHC	200ug	76570
CLSBF0422	DDR2 antibody	97kDa	Human	ELISA, WB, IHC, ICC	200ug	76570
CLSBF0423	CD34 antibody	41kDa	Human	ELISA, WB, IHC, ICC	200ug	76570
CLSBF0424	Myoglobin antibody	17kDa	Human	ELISA, WB, IHC	200ug	76570
CLSBF0425	GLP antibody	20kDa	Human	ELISA, WB	200ug	76570
CLSBF0427	Nucleophosmin antibody	33kDa	Human; Monkey	ELISA, WB, IHC, ICC	200ug	76570
CLSBF0429	LPA antibody	501kDa	Human	ELISA, WB, IHC, ICC	200ug	76570
CLSBF0432	SOX9 antibody	56kDa	Human	ELISA, WB, ICC	200ug	76570
CLSBF0433	DLK1 antibody	41kDa	Human;	ELISA, WB, ICC, FCM	200ug	76570
CLSBF0434	PSMB8 antibody	30kDa	Human; Rat	ELISA, WB, IHC, ICC	200ug	76570
CLSBF0438	PAX4 antibody	38kDa	Human	ELISA, WB	200ug	76570
CLSBF0439	CDKN1C antibody	57kDa	Human	ELISA, WB	200ug	76570
CLSBF0440	KLF4 antibody	54kDa	Human	ELISA, WB, IHC, ICC	200ug	76570
CLSBF0441	Rab10 antibody	22.5kDa	Human; Mouse	ELISA, WB, ICC	200ug	76570
CLSBF0442	MESP1 antibody	28.5kDa	Human	ELISA, WB	200ug	76570
CLSBF0443	EGR1 antibody	57.5kDa	Human	ELISA, WB	200ug	76570
CLSBF0444	GOT2 antibody	47kDa	Human; Mouse; Rat; Monkey	ELISA, WB, ICC	200ug	76570
CLSBF0445	CD38 antibody	34kDa	Human	ELISA, WB, IHC	200ug	76570
CLSBF0446	Neurogenin-3 antibody	23kDa	Human	ELISA, WB	200ug	76570
CLSBF0447	SOD1 antibody	18kDa	Human; Mouse	ELISA, WB, ICC, FCM	200ug	76570
CLSBF0449	SKP2 antibody	47kDa	Human	ELISA, WB	200ug	76570
CLSBF0450	PAR1 antibody	47kDa	Human	ELISA, WB	200ug	76570
CLSBF0451	SND1/P100 antibody	102kDa	Human	ELISA, WB	200ug	76570
CLSBF0452	FBLN5 antibody	50kDa	Human	ELISA, WB, IHC	200ug	76570
CLSBF0453	HCK antibody	59kDa	Human	ELISA, WB, IHC	200ug	76570
CLSBF0454	TIP60 antibody	60kDa	Human;	ELISA, WB, IHC	200ug	76570
CLSBF0455	AURKB antibody	39kDa	Human	ELISA, WB	200ug	76570
CLSBF0456	Lck antibody	56kDa	Human	ELISA, WB	200ug	76570
CLSBF0457	Rab25 antibody	24kDa	Human	ELISA, WB, IHC	200ug	76570
CLSBF0460	E2F1 antibody	46.9kDa	Human; Mouse	ELISA, WB, IHC, FCM	200ug	76570
CLSBF0461	mouse Splunc2 antibody	25kDa	Human	ELISA, WB, IHC, ICC, FCM	200ug	76570
CLSBF0462	PIK3CA antibody	124kDa	Human	ELISA, WB, ICC, FCM	200ug	76570
CLSBF0463	MPL antibody	71.2kDa	Human	ELISA, WB, FCM	200ug	76570
CLSBF0465	KIT antibody	145kDa	Human	ELISA, WB, IHC	200ug	76570
CLSBF0466	NFKB1 antibody	50kDa/105kDa	Human	ELISA, WB, IHC, ICC, FCM	200ug	76570
CLSBF0467	MYC antibody	49kDa	Human	ELISA, WB	200ug	76570
CLSBF0469	GYS1 antibody	85kDa	Human	ELISA, WB, FCM	200ug	76570
CLSBF0471	KLHL22 antibody	72kDa	Human	ELISA, WB, ICC	200ug	76570
CLSBF0472	THAP11 antibody	44kDa	Human	ELISA, WB, IHC, ICC, FCM	200ug	76570
CLSBF0473	KLHL12 antibody	63kDa	Human	ELISA, WB	200ug	76570
CLSBF0474	ARNTL antibody	68.7kDa	Human	ELISA, WB, IHC	200ug	76570
CLSBF0475	CSF1 antibody	60kDa	Human	ELISA, WB, IHC	200ug	76570
CLSBF0476	NGFR antibody	45kDa	Human	ELISA, WB, ICC, FCM	200ug	76570
CLSBF0478	REG1A antibody	19kDa	Human	ELISA, IHC, ICC	200ug	76570
CLSBF0479	FMR1 antibody	71kDa	Human	ELISA, WB, IHC, ICC	200ug	76570
CLSBF0481	SOX2 antibody	34.3kDa	Human	ELISA, WB	200ug	76570
CLSBF0482	ETV4 antibody	54kDa	Human	ELISA, WB	200ug	76570
CLSBF0486	S100A1 antibody	11kDa	Human	ELISA, WB, IHC	200ug	76570
CLSBF0487	CIB1 antibody	22kDa	Human	ELISA, WB, IHC	200ug	76570
CLSBF0488	EphA1 antibody	108kDa	Human	ELISA, WB, IHC	200ug	76570
CLSBF0489	CD14 antibody	40kDa	Human	ELISA, IHC, FCM	200ug	76570
CLSBF0492	MELK antibody	74.6kDa	Human	ELISA, IHC, ICC, FCM	200ug	76570
CLSBF0493	CK5 antibody	62.3kDa	Human; Mouse; Monkey	ELISA, WB, IHC, ICC, FCM	200ug	76570
CLSBF0494	CD30 antibody	64kDa	Human	ELISA, WB, FCM	200ug	76570

Antibodies
HSN : 38220090

Cat#	Product Description	MW	Reactivity	Application	Pack Size	Unit Price
CLSBF0497	KRT19 antibody	41kDa	Human	ELISA, WB, IHC, ICC	200ug	76570
CLSBF0499	GRK2 antibody	80kDa	Human; Mouse; Rat; Monkey	ELISA, WB, IHC, ICC	200ug	76570
CLSBF0501	CTCF antibody	83kDa	Human; Monkey	ELISA, WB	200ug	76570
CLSBF0504	WDR5 antibody	36.6kDa	Human	ELISA, WB	200ug	76570
CLSBF0505	MUM1 antibody	78.6kDa	Human	ELISA, WB, IHC	200ug	76570
CLSBF0506	CSF2 antibody	16kDa	Human	ELISA, WB	200ug	76570
CLSBF0507	PPP1A antibody	38kDa	Human; Mouse	ELISA, WB	200ug	76570
CLSBF0508	Metadherin antibody	64kDa	Human	ELISA, WB, IHC, FCM	200ug	76570
CLSBF0509	ROR1 antibody	101kDa	Human	ELISA, WB, ICC	200ug	76570
CLSBF0511	R-spondin1 antibody	28.9kDa	Human	ELISA, WB	200ug	76570
CLSBF0514	EphA4 antibody	110kDa	Human	ELISA, WB	200ug	76570
CLSBF0515	Calnexin antibody	90kDa	Human	ELISA, WB, ICC	200ug	76570
CLSBF0520	CD3 antibody	23kDa	Human	ELISA, ICC	200ug	76570
CLSBF0521	IL-1a antibody	17 31kDa.	Human	ELISA, WB	200ug	76570
CLSBF0524	troponin T2 antibody	36kDa	Human	ELISA, WB, FCM	200ug	76570
CLSBF0525	LRP5 antibody	179kDa	Human	ELISA, WB, FCM	200ug	76570
CLSBF0526	MMP3 antibody	54kDa	Human	ELISA, WB, FCM	200ug	76570
CLSBF0527	RSK2 antibody	80kDa	Human	ELISA, WB, ICC, FCM	200ug	76570
CLSBF0528	MAPK3 antibody	44kDa	Human; Mouse; Rat; Monkey	ELISA, WB, IHC, ICC, FCM	200ug	76570
CLSBF0529	MMP1 antibody	54kDa	Human	ELISA, WB, IHC, ICC, FCM	200ug	76570
CLSBF0531	CCND3 antibody	32kDa	Human; Mouse	ELISA, WB	200ug	76570
CLSBF0534	WIF1 antibody	42kDa	Human	ELISA, WB, IHC, ICC	200ug	76570
CLSBF0535	PTH1R antibody	66kDa	Human	ELISA, WB, IHC, ICC	200ug	76570
CLSBF0536	FLT4 antibody	145kDa	Human	ELISA, WB	200ug	76570
CLSBF0537	XBP1 antibody	28kDa	Human	ELISA, WB	200ug	76570
CLSBF0539	ST13 antibody	48kDa	Human; Monkey	ELISA, WB, IHC, ICC	200ug	76570
CLSBF0540	NKX2.5 antibody	35kDa	Human	ELISA, WB	200ug	76570
CLSBF0541	TBX5 antibody	53kDa	Human	ELISA, WB	200ug	76570
CLSBF0542	LCN1 antibody	19.2kDa	Human	ELISA, WB, IHC, ICC	200ug	76570
CLSBF0544	human Albumin antibody	69kDa	Human	ELISA, WB	200ug	76570
CLSBF0545	KARS antibody	74kDa	Human	ELISA, WB, IHC	200ug	76570
CLSBF0547	IKBKE antibody	80kDa	Human	ELISA, WB	200ug	76570
CLSBF0548	PRAK antibody	55kDa	Human	ELISA, WB, IHC	200ug	76570
CLSBF0549	C-Kit antibody	145kDa	Human	ELISA, WB, IHC	200ug	76570
CLSBF0551	LSD1/AOF2 antibody	93kDa	Human; Mouse; Monkey	ELISA, WB, IHC	200ug	76570
CLSBF0555	PPM1A antibody	42.4kDa	Human; Monkey	ELISA, WB, FCM	200ug	76570
CLSBF0556	CCL2 antibody	11kDa	Human; Mouse; Monkey	ELISA, WB, IHC, ICC, FCM	200ug	76570
CLSBF0557	FAS antibody	37.7kDa	human	ELISA, WB, ICC, FCM	200ug	76570
CLSBF0558	TUBA8 antibody	50kDa	Human; Rat	ELISA, WB, IHC, ICC, FCM	200ug	76570
CLSBF0560	MMP9 antibody	92kDa	Human	ELISA, WB, IHC, ICC, FCM	200ug	76570
CLSBF0562	CST3 antibody	42kDa	Human	ELISA, WB	200ug	76570
CLSBF0563	p63alpha antibody	51kDa	Human; Mouse; Rat; Monkey	ELISA, WB, IHC	200ug	76570
CLSBF0564	GCG antibody	21kDa	Human	ELISA, WB	200ug	76570
CLSBF0565	SCGB2A2 antibody	11kDa	Human	ELISA, WB, IHC, ICC, FCM	200ug	76570
CLSBF0567	CRTC1 antibody	67kDa	Human	ELISA, WB, ICC, FCM	200ug	76570
CLSBF0568	GATA3 antibody	48kDa	Human	ELISA, WB, IHC	200ug	76570
CLSBF0569	A1BG antibody	54kDa	Human	ELISA, WB, IHC	200ug	76570
CLSBF0570	AKT1 antibody	56kDa	Human; Mouse; Monkey	ELISA, WB	200ug	76570
CLSBF0571	FABP4 antibody	14kDa	Human	ELISA, WB	200ug	76570
CLSBF0572	TUBB3 antibody	50kDa	Human	ELISA, WB, ICC, FCM	200ug	76570
CLSBF0574	KLF15 antibody	44kDa	Human	ELISA, WB	200ug	76570
CLSBF0575	SYT1 antibody	60kDa	Human	ELISA, WB	200ug	76570
CLSBF0576	RON antibody	152kDa	Human	ELISA, WB	200ug	76570
CLSBF0577	CHK2 antibody	61kDa	Human	ELISA, WB, IHC, ICC	200ug	76570
CLSBF0578	APOA1 antibody	25kDa	Human	ELISA, WB	200ug	76570
CLSBF0580	Human P16 antibody	40kDa	Human	ELISA, WB, IHC	200ug	76570
CLSBF0581	PR antibody	99kDa	Human	ELISA, WB, IHC	200ug	76570
CLSBF0582	SNCA antibody	18kDa	Human	ELISA, WB, IHC	200ug	76570
CLSBF0583	CD8 antibody	25kDa	Human	ELISA	200ug	76570
CLSBF0584	IL-16 antibody	20kDa	Human	ELISA, WB	200ug	76570
CLSBF0586	RAB4A antibody	23.8kDa	Human; Mouse; Monkey	ELISA, WB, IHC, FCM	200ug	76570
CLSBF0587	ITGA4 antibody	115kDa	Human	ELISA, WB, FCM	200ug	76570
CLSBF0588	COTL1 antibody	16kDa	Human	ELISA, WB, IHC	200ug	76570
CLSBF0590	JUP antibody	82kDa	Human	ELISA, WB, IHC, ICC	200ug	76570

Antibodies
HSN : 38220090

Cat#	Product Description	MW	Reactivity	Application	Pack Size	Unit Price
CLSBF0591	AIF antibody	67kDa	Human; Mouse; Monkey; Rat	ELISA, WB, IHC, ICC, FCM	200ug	76570
CLSBF0592	SMN1 antibody	39kDa	Human; Monkey	ELISA, WB, IHC, FCM	200ug	76570
CLSBF0593	HIF1A antibody	120kDa	Human; Mouse; Monkey	ELISA, WB, IHC, ICC	200ug	76570
CLSBF0594	PRKDC antibody	46.9kDa	Human	ELISA, WB, IHC, ICC	200ug	76570
CLSBF0595	SNAI1 antibody	29kDa	Human	ELISA, WB	200ug	76570
CLSBF0596	CRTC2 antibody	80kDa	Human; Monkey	ELISA, WB, IHC, ICC, FCM	200ug	76570
CLSBF0597	UBE1L antibody	112kDa	Human	ELISA, WB	200ug	76570
CLSBF0599	CDKN1B antibody	22kDa	Human	ELISA, WB	200ug	76570
CLSBF0600	ETS1 antibody	50.4kDa	Human	ELISA, WB, IHC	200ug	76570
CLSBF0601	HAUSP antibody	128kDa	Human	ELISA, WB	200ug	76570
CLSBF0602	PTEN antibody	54kDa	Human; Mouse	ELISA, WB, ICC, FCM	200ug	76570
CLSBF0603	CD40 antibody	30kDa	Human	ELISA, ICC	200ug	76570
CLSBF0604	p53 antibody	43.7kDa	Human	ELISA, WB, IHC	200ug	76570
CLSBF0605	APOA4 antibody	45kDa	Human	ELISA, WB	200ug	76570
CLSBF0606	Cytokeratin 8 antibody	54kDa	Human	ELISA, WB, IHC, ICC	200ug	76570
CLSBF0607	EphA3 antibody	110kDa	Human	ELISA, WB	200ug	76570
CLSBF0608	ITK antibody	68kDa	Human	ELISA, WB	200ug	76570
CLSBF0609	EhpB1 antibody	110kDa	Human	ELISA, WB, IHC	200ug	76570
CLSBF0611	CD31 antibody	100kDa	Human	ELISA, WB, IHC, ICC	200ug	76570
CLSBF0613	EphA2 antibody	120kDa	Human	ELISA, WB, IHC	200ug	76570
CLSBF0614	RB antibody	106kDa	Human	ELISA, IHC	200ug	76570
CLSBF0615	Apoa5 (ab) antibody	41kDa	Human	ELISA, WB	200ug	76570
CLSBF0617	INCENP antibody	105.4kDa	Human	ELISA, WB, IHC, ICC, FCM	200ug	76570
CLSBF0618	MAP1LC3B antibody	14.6kDa	Human	ELISA, WB, FCM	200ug	76570
CLSBF0619	MSN antibody	67.8kDa	Human; Monkey	ELISA, WB, IHC, FCM	200ug	76570
CLSBF0621	MBP antibody	33kDa	Human	ELISA, WB, IHC, ICC, FCM	200ug	76570
CLSBF0622	AIB1 antibody	155kDa	Human	ELISA, WB	200ug	76570
CLSBF0623	GKAP antibody	109kDa	Human	ELISA, WB, IHC, ICC	200ug	76570
CLSBF0624	HSP27 antibody	27kDa	Human; Rat	ELISA, WB, IHC, ICC, FCM	200ug	76570
CLSBF0625	CTTN antibody	80kDa	Human; Mouse	ELISA, WB, IHC	200ug	76570
CLSBF0627	FCER2 antibody	37kDa	Human	ELISA, FCM	200ug	76570
CLSBF0628	INHA antibody	40kDa	Human; Mouse	ELISA, WB, ICC	200ug	76570
CLSBF0629	KDM4A antibody	120kDa	Human	ELISA, WB, IHC, ICC	200ug	76570
CLSBF0630	FOXP3 antibody	47.2kDa	Human	ELISA, WB	200ug	76570
CLSBF0631	SNAI2 antibody	30kDa	Human	ELISA, WB	200ug	76570
CLSBF0632	TCF3 antibody	67.6kDa	Human	ELISA, WB, FCM	200ug	76570
CLSBF0633	HSP70 antibody	70kDa	Human	ELISA, WB, IHC, ICC	200ug	76570
CLSBF0634	MATK antibody	56kDa	Human	ELISA, WB, FCM	200ug	76570
CLSBF0636	LPL antibody	53.1kDa	Human	ELISA, WB	200ug	76570
CLSBF0637	CD45 antibody	155kDa	Human	ELISA, WB, IHC	200ug	76570
CLSBF0638	LIN28 antibody	23kDa	Human	ELISA, WB, ICC	200ug	76570
CLSBF0639	PARL antibody	42kDa	Human	ELISA, WB	200ug	76570
CLSBF0640	MAPK10 antibody	53kDa	Human; Mouse	ELISA, WB, ICC	200ug	76570
CLSBF0641	Calreticulin antibody	63kDa	Human	ELISA, WB	200ug	76570
CLSBF0643	LYN antibody	56kDa	Human	ELISA, WB	200ug	76570
CLSBF0644	Tyk2 antibody	140kDa	Human	ELISA, WB	200ug	76570
CLSBF0645	NPT antibody	30kDa	Human	ELISA, WB	200ug	76570
CLSBF0649	MYF6 antibody	27kDa	Human	ELISA, WB	200ug	76570
CLSBF0650	CEBPA antibody	42kDa	Human	ELISA, WB, IHC, ICC, FCM	200ug	76570
CLSBF0652	BIRC5 antibody	16kDa	Human	ELISA, WB, IHC, ICC, FCM	200ug	76570
CLSBF0656	TDGF1 antibody	21kDa	Human	ELISA, WB	200ug	76570
CLSBF0657	MSI2 antibody	35kDa	Human	ELISA, WB, IHC	200ug	76570
CLSBF0658	CARM1 antibody	65kDa	Human; Monkey; Rat	ELISA, WB, IHC, ICC, FCM	200ug	76570
CLSBF0660	CD276 antibody	57kDa	Human	ELISA, WB, IHC, FCM	200ug	76570
CLSBF0663	NKX3A antibody	26.3kDa	Human	ELISA, WB, IHC, FCM	200ug	76570
CLSBF0664	AKT2 antibody	60kDa	Human; Rat; Monkey	ELISA, WB, IHC, ICC	200ug	76570
CLSBF0665	ITGA5 antibody	114kDa	Human	ELISA, WB, IHC, FCM	200ug	76570
CLSBF0667	MUSK antibody	97kDa	Human	ELISA, IHC, ICC	200ug	76570
CLSBF0668	ApoO antibody	22.2kDa	Human; Mouse	ELISA, WB, IHC	200ug	76570
CLSBF0669	EphA6 antibody	116kDa	Human	ELISA, WB	200ug	76570
CLSBF0671	CA1 antibody	29kDa	Human	ELISA, WB	200ug	76570
CLSBF0674	ER antibody	66kDa	Human	ELISA, WB	200ug	76570
CLSBF0677	APOA5 antibody	41kDa	Human	ELISA, WB, ICC	200ug	76570
CLSBF0678	MCP-1 antibody	13kDa	human	ELISA, WB	200ug	76570

Antibodies
HSN : 38220090

Cat#	Product Description	MW	Reactivity	Application	Pack Size	Unit Price
CLSBF0680	GRIA2 antibody	98.8kDa	Human	ELISA, WB, FCM	200ug	76570
CLSBF0681	HAS3 antibody	63kDa	Human	ELISA, WB, IHC, FCM	200ug	76570
CLSBF0683	PPP1CA antibody	38kDa	Human	ELISA, WB	200ug	76570
CLSBF0684	IL1B antibody	31kDa	Human;	ELISA, WB, IHC, ICC	200ug	76570
CLSBF0686	BLNK antibody	68kDa	Human; Mouse	ELISA, WB, IHC, ICC, FCM	200ug	76570
CLSBF0687	FUK antibody	117kDa	Human; Mouse; Rat; Monkey	ELISA, WB, FCM	200ug	76570
CLSBF0688	BECN1 antibody	60kDa	Human	ELISA, WB, IHC, FCM	200ug	76570
CLSBF0691	CD86 antibody	52kDa	Human	ELISA, WB	200ug	76570
CLSBF0694	RAG2 antibody	59kDa	Human	ELISA, WB	200ug	76570
CLSBF0695	GSK3B antibody	46kDa	Human; Rat; Mouse; Monkey	ELISA, WB, IHC, ICC, FCM	200ug	76570
CLSBF0696	BMP4 antibody	64kDa	Human	ELISA, WB	200ug	76570
CLSBF0699	DKK1 antibody	28.7kDa	Human	ELISA, WB	200ug	76570
CLSBF0700	EphA5 antibody	114kDa	Human	ELISA, WB	200ug	76570
CLSBF0701	NCOR1 antibody	270kDa	Human	ELISA, WB, IHC	200ug	76570
CLSBF0703	EphB2 antibody	110kDa	Human	ELISA, WB, ICC	200ug	76570
CLSBF1000	ALDH2 antibody	56.3kDa	Human; Mouse; Rat;	WB IHC IF FCM	200ug	76570
CLSBF1001	GLUT4 Antibody	54.8kDa	Human; Mouse;	WB IHC IF FC	200ug	76570
CLSBF1002	Lamin B1 Antibody	68KD	Human, Mouse, Rat	WB IP	200ug	76570
CLSBF1003	SMAD4 antibody	65kDa	Human Mouse	WB IHC IF FCM	200ug	76570
CLSBF1004	SMAD6 Antibody	53kDa	Human	WB	200ug	76570
CLSBF2001	AMPK alpha 1 Antiboy	64KD	Human; Monkey; Mouse; Rat	WB IHC IF FCM	200ug	76570
CLSBF2002	TGFBR3 antibody	93.4kDa	Human Mouse	WB FCM	200ug	76570
CLSBF3001	VWF Antibody	309kd	Human Mouse	ELISA IHC	200ug	76570
CLSBF9001	Histone H3 (di methyl K79) Mouse Monoclonal Antibody	15KD	Human, Mouse, Rat	WB	200ug	59670
CLSBF9002	Histone H3 (tri methyl K36) Mouse Monoclonal Antibody	15 KD	Human, Mouse, Rat	WB	200ug	59670
CLSBF9003	Histone H3 (tri methyl K79) Mouse Monoclonal Antibody	15 KD	Human, Mouse, Rat	WB	200ug	59670
CLSBF9004	Histone H3 (tri methyl K79) Mouse Monoclonal Antibody	15 KD	Human, Mouse, Rat	WB	200ug	59670
CLSBF9005	Histone H3 (mono methyl K79) Mouse Monoclonal Antibody	15 KD	Human, Mouse, Rat	WB	200ug	59670
CLSBF9006	Histone H3 (tri methyl K79) Mouse Monoclonal Antibody	15 KD	Human, Mouse, Rat	WB	200ug	59670
CLSBF9007	Histone H3(tri methyl K9) Mouse Monoclonal Antibody		Human, Mouse, Rat	WB	200ug	59670
CLSBF9008	Histone H3(di methyl K27) Mouse Monoclonal Antibody	15 KD	Human, Mouse, Rat	WB	200ug	59670
CLSBF9009	Histone H3(tri methyl K4) Mouse Monoclonal Antibody	15 KD	Human, Mouse, Rat	WB	200ug	59670
CLSBF9010	Fibronectin Mouse mAb	285KD	Human	WB IHC	200ug	59670
CLSBF9011	eIF4A1 Mouse mAb	48 KD	Human, Mouse, Rat	WB	200ug	59670
CLSBF9012	HSP70 Mouse mAb	70 KD	Human, Mouse, Rat	WB	200ug	59670
CLSBF9104	Aquaporin 4 Mouse mAb	48 KD	Human, Mouse, Rat	WB IF	200ug	59670
CLSBF9105	EGFR Mouse mAb	170KD	Human	WB IP	200ug	59670
CLSBF9106	Cleaved PARP Mouse mAb	86 116KD	Human	WB	200ug	59670
CLSBF9107	HSP90β Mouse mAb	90KD	Human, Mouse, Rat	WB	200ug	59670
CLSBF9201	ErbB-2/HER2 Mouse mAb	138	Human, Mouse, Rat	WB IHC	200ug	59670
CLSBF9202	CK7 Mouse mAb	51kDa	Human, Mouse, Rat	WB	200ug	59670
CLSBF9203	AFP/alpha 1 Fetoprotein Mouse mAb	70 KD	Human	WB	200ug	59670
CLSBF9204	XRCC4 Mouse mAb	38KD	Human	WB	200ug	59670
CLSBF9205	Oct1 Mouse mAb	89	Human	WB	200ug	59670
CLSBF9206	Caspase 9 Mouse mAb	47KD(H), 51KD(R, M)	Human, Mouse, Rat	WB	200ug	59670
CLSBF9207	CD16 Mouse mAb	45	Human	WB IHC	200ug	59670
CLSBF9208	Collagen III Mouse mAb	138	Human, Mouse, Rat	WB IHC	200ug	59670
CLSBF9209	PCNA Mouse mAb	36kDa	Human, Mouse, Rat	WB IHC IF	200ug	59670
CLSBF9210	alpha-tubulin Mouse mAb	52KD	Human, Mouse, Rat	WB IP IF	200ug	59670
CLSBF9211	Histone H3 Mouse mAb	15	Human, Mouse, Rat	WB IF IP	200ug	59670
CLSBF9212	alpha SMA antibody	42kDa	Human, Mouse, Rat	WB IP IF	200ug	59670
CLSBF9213	Ki67 Mouse mAb		Human, Mouse, Rat	IHC	200ug	59670
CLSBF9214	MAP2 Mouse mAb		Human, Mouse, Rat	IHC	200ug	59670
CLSBF9215	GFAP Mouse mAb	50 KD	Mouse Rat	WB IHC	200ug	59670
CLSBF9216	Transferrin Mouse mAb	77KD	Human	WB	200ug	59670
CLSBF9217	Flotillin-1 Mouse mAb	49	Human, Mouse, Rat	WB	200ug	59670
CLSBF9300	eNOS Mouse mAb	50ug/50ul ,100ug/100ul	Human	WB IHC	200ug	59670
CLSBF9301	Progesterone Receptor Mouse mAb	50ug/50ul ,100ug/100ul	Human Mouse Rat	WB IHC	200ug	59670

Antibodies
HSN : 38220090

Cat#	Product Description	MW	Reactivity	Application	Pack Size	Unit Price
CLSBF9302	P65 Mouse mAb	50ug/50ul .100ug/100ul	Human Mouse Rat	WB IHC	200ug	59670
CLSBF9303	cox2 Mouse mAb	50ug/50ul .100ug/100ul	Human Mouse Rat	WB IHC	200ug	59670
CLSBF9304	p53 Mouse mAb	50ug/50ul .100ug/100ul	Human Mouse Rat	WB IHC	200ug	59670
CLSBF9305	NSE Mouse mAb	50ug/50ul .100ug/100ul	Human Mouse	WB IHC	200ug	59670
CLSBF9306	β-Catenin Mouse mAb	50ug/50ul .100ug/100ul	Human Mouse Rat	WB IHC	200ug	59670
CLSDF2200	DIRAS3 Antibody	26 kDa.	Human	WB500-1:2000 IHC 1:50-1:200	200ug	59670
CLSDF2201	GEM Antibody	23.5 kDa	Human	WB500-1:2000 IHC 1:50-1:200	200ug	59670
CLSDF2202	MCF2L Antibody		Human	WB500-1:2000 IHC 1:50-1:200	200ug	59670
CLSDF2203	GNA12 Antibody	44 kDa.	Human, Mouse, Rat	WB500-1:2000	200ug	59670
CLSDF2204	GNA13 Antibody	44 kDa	Human, Mouse, Rat	WB500-1:2000	200ug	59670
CLSDF2205	GNG10 Antibody		Human, Mouse, Rat	WB500-1:2000	200ug	59670
CLSDF2206	GNG11 Antibody	8 kDa.	Human, Mouse, Rat	WB500-1:2000	200ug	59670
CLSDF2207	LRRC42 Antibody	49 kDa	Human, Mouse, Rat	WB500-1:2000	200ug	59670
CLSDF2208	LDHAL6A Antibody	36 kDa	Human	WB500-1:2000 IHC 1:50-1:200	200ug	59670
CLSDF2209	SLC25A27 Antibody	27 kDa	Human, Mouse, Rat	WB500-1:2000	200ug	59670
CLSDF2210	MYO1F Antibody	125 kDa.	Human, Mouse, Rat	WB500-1:2000	200ug	59670
CLSDF2211	NDUFA10 Antibody	41 kDa	Human	WB500-1:2000 IHC 1:50-1:200	200ug	59670
CLSDF2212	NDUFB2 Antibody		Human, Mouse	WB500-1:2000	200ug	59670
CLSDF2213	NDUFB6 Antibody	15 kDa	Human, Mouse, Rat	WB500-1:2000	200ug	59670
CLSDF2214	UNC5C Antibody	66 kDa	Human, Mouse, Rat	WB500-1:2000	200ug	59670
CLSDF2215	NBPF4 Antibody		Human	WB500-1:2000 IHC 1:50-1:200	200ug	59670
CLSDF2216	NEUROD6 Antibody	38 kDa)	Human, Mouse, Rat	WB500-1:2000	200ug	59670
CLSDF2217	NFE2L1 Antibody	82 kDa	Human, Mouse	WB500-1:2000	200ug	59670
CLSDF2218	NOC4L Antibody	58 kDa.	Human	WB500-1:2000 IHC 1:50-1:200	200ug	59670
CLSDF2219	NR2C2 Antibody	65 kDa	Human, Mouse, Rat	WB500-1:2000	200ug	59670
CLSDF2220	PSPC1 Antibody	58 kDa	Human	WB500-1:2000 IHC 1:50-1:200	200ug	59670
CLSDF2221	PEX1 Antibody	142 kDa	Human, Mouse	WB500-1:2000	200ug	59670
CLSDF2222	KCNE2 Antibody	14 kDa	Human, Mouse, Rat	WB500-1:2000	200ug	59670
CLSDF2223	ATP12A Antibody		Human	WB500-1:2000 IHC 1:50-1:200	200ug	59670
CLSDF2224	SYF2 Antibody		Human, Mouse, Rat	WB500-1:2000	200ug	59670
CLSDF2225	EGF Antibody	78 kDa	Human	WB500-1:2000 IHC 1:50-1:200	200ug	59670
CLSDF2226	EPB41 Antibody	97 kDa	Human, Mouse	WB500-1:2000	200ug	59670
CLSDF2227	PDP2 Antibody	60 kDa	Human	WB500-1:2000 IHC 1:50-1:200	200ug	59670
CLSDF2228	PDHA2 Antibody	43 kDa	Human	WB500-1:2000 IHC 1:50-1:200	200ug	59670
CLSDF2229	RALGDS Antibody	100 kDa	Human, Mouse, Rat	WB500-1:2000	200ug	59670
CLSDF2230	RASSF7 Antibody	40 kDa	Human, Mouse	WB500-1:2000	200ug	59670
CLSDF2231	RFPL1 Antibody	35 kDa	Human	WB500-1:2000 IHC 1:50-1:200	200ug	59670
CLSDF2232	ELL2 Antibody	72 kDa	Human, Mouse	WB500-1:2000	200ug	59670
CLSDF2233	SEPT10 Antibody	53 kDa	Human, Mouse, Rat	WB500-1:2000	200ug	59670
CLSDF2234	RIOK2 Antibody	63 kDa	Human	WB500-1:2000 IHC 1:50-1:200	200ug	59670
CLSDF2235	PPP1R10 Antibody	99 kDa	Human, Mouse, Rat	WB500-1:2000	200ug	59670
CLSDF2236	SH3BP2 antibody	62 kDa	Human	WB500-1:2000 IHC 1:50-1:200	200ug	59670
CLSDF2237	KCNN1 Antibody	60 kDa	Human, Mouse, Rat	WB500-1:2000	200ug	59670
CLSDF2238	CCL20 Antibody	11 kDa	Human	WB500-1:2000 IHC 1:50-1:200	200ug	59670
CLSDF2239	CCL23 Antibody		Human	WB500-1:2000 IHC 1:50-1:200	200ug	59670
CLSDF2240	CCL24 Antibody	13 kDa	Human	WB500-1:2000 IHC 1:50-1:200	200ug	59670
CLSDF2241	SCN3A Antibody	226 kDa	Human	WB500-1:2000 IHC 1:50-1:200	200ug	59670
CLSDF2242	SLC5A5 Antibody	69 kDa	Human	WB500-1:2000 IHC 1:50-1:200	200ug	59670
CLSDF2243	SLC6A3 Antibody	69 kDa	Human, Mouse, Rat	WB500-1:2000	200ug	59670
CLSDF2244	SLC34A2 Antibody		Human	WB500-1:2000 IHC 1:50-1:200	200ug	59670

Antibodies
HSN : 38220090

Cat#	Product Description	MW	Reactivity	Application	Pack Size	Unit Price
CLSDF2245	SLC12A2 Antibody	130 kDa	Human, Mouse, Rat	WB500-1:2000	200ug	59670
CLSDF2246	SF3A3 Antibody	59 kDa	Human, Mouse, Rat	WB500-1:2000	200ug	59670
CLSDF2247	GPSN2 Antibody	36 kDa	Human, Mouse, Rat	WB500-1:2000	200ug	59670
CLSDF2248	TCAP Antibody	19 kDa	Human	WB500-1:2000 IHC 1:50-1:200	200ug	59670
CLSDF2250	TJP1 Antibody	240 kDa	Human, Mouse	WB500-1:2000	200ug	59670
CLSDF2251	VGLL2 Antibody	33 kDa	Human, Mouse, Rat	WB500-1:2000	200ug	59670
CLSDF2253	TAF7 Antibody	40 kDa	Human, Mouse, Rat	WB500-1:2000	200ug	59670
CLSDF2254	EIF2B2 Antibody	39 kDa.	Human, Mouse, Rat	WB500-1:2000	200ug	59670
CLSDF2255	TSEN2 Antibody	54 kDa	Human	WB500-1:2000 IHC 1:50-1:200	200ug	59670
CLSDF2256	TNNT3 Antibody	32 kDa	Human	WB500-1:2000 IHC 1:50-1:200	200ug	59670
CLSDF2257	USP1 Antibody	88 kDa	Human	WB500-1:2000 IHC 1:50-1:200	200ug	59670
CLSDF2258	USP28 Antibody	122 kDa	Human, Mouse, Rat	WB500-1:2000	200ug	59670
CLSDF2259	USP37 Antibody	120 kDa	Human	WB500-1:2000 IHC 1:50-1:200	200ug	59670
CLSDF2260	USP48 Antibody	145 kDa	Human, Mouse, Rat	WB500-1:2000	200ug	59670
CLSDF2261	UBE2D3 Antibody	17 kDa	Human, Mouse, Rat	WB500-1:2000	200ug	59670
CLSDF2262	UBE2R2 Antibody	27 kDa	Human, Mouse	WB500-1:2000	200ug	59670
CLSDF2263	ATP6V1D Antibody	28 kDa	Human, Mouse, Rat	WB500-1:2000	200ug	59670
CLSDF2264	VPS4B Antibody	49 kDa	Human, Mouse, Rat	WB500-1:2000	200ug	59670
CLSDF2265	CACNG5 Antibody	31 kDa	Human, Mouse, Rat	WB500-1:2000	200ug	59670
CLSDF2266	CACNG8 Antibody	43 kDa	Human, Mouse, Rat	WB500-1:2000	200ug	59670
CLSDF2267	CACNA1C Antibody	249 kDa	Human, Mouse, Rat	WB500-1:2000	200ug	59670
CLSDF2268	CACNB4 Antibody	60 kDa	Human, Mouse, Rat	WB500-1:2000	200ug	59670
CLSDF2269	ACTC1 Antibody	42 kDa	Human, Mouse, Rat	WB500-1:2000	200ug	59670
CLSDF2270	ADCY2 Antibody	110 kDa	Human, Mouse, Rat	WB500-1:2000	200ug	59670
CLSDF2271	ADCY8 Antibody	140 kDa	Human, Mouse, Rat	WB500-1:2000	200ug	59670
CLSDF2272	APAF1 Antibody	135 kDa	Human, Mouse, Rat	WB500-1:2000	200ug	59670
CLSDF2273	APR3 Antibody	22 kDa	Human	WB500-1:2000 IHC 1:50-1:200	200ug	59670
CLSDF2274	ASPP1 Antibody	120 kDa	Human, Mouse	WB500-1:2000	200ug	59670
CLSDF2275	ASPP2 Antibody	170 kDa	Human, Mouse	WB500-1:2000	200ug	59670
CLSDF2276	BCL2L10 Antibody	22 kDa	Human	WB500-1:2000 IHC 1:50-1:200	200ug	59670
CLSDF2278	CDH12 Antibody	88 kDa	Human, Mouse	WB500-1:2000	200ug	59670
CLSDF2279	CDH6 Antibody	88 kDa	Human, Mouse, Rat	WB500-1:2000	200ug	59670
CLSDF2281	CCAR1 Antibody	132 kDa	Human, Mouse	WB500-1:2000	200ug	59670
CLSDF2282	CCNA2 Antibody	50 kDa	Human, Mouse, Rat	WB500-1:2000	200ug	59670
CLSDF2283	CCNC Antibody	38 kDa	Human, Mouse, Rat	WB500-1:2000	200ug	59670
CLSDF2284	CCNG2 Antibody	39 kD	Human, Mouse	WB500-1:2000	200ug	59670
CLSDF2286	CCNK Antibody	64 kDa	Human, Mouse	WB500-1:2000	200ug	59670
CLSDF2287	CCNL2 Antibody	58 kDa	Human, Mouse, Rat	WB500-1:2000	200ug	59670
CLSDF2288	CCNT1 Antibody	87 kDa	Human	WB500-1:2000 IHC 1:50-1:200	200ug	59670
CLSDF2289	CCNT2 Antibody	81kDa	Human, Mouse, Rat	WB500-1:2000	200ug	59670
CLSDF2290	CCNY Antibody	39 kDa	Human, Mouse	WB500-1:2000	200ug	59670
CLSDF2291	CD109 Antibody	162 kDa	Human, Mouse	WB500-1:2000	200ug	59670
CLSDF2292	CD166 Antibody	100-105 kDa	Human, Mouse, Rat	WB500-1:2000	200ug	59670
CLSDF2293	CD177 Antibody	46 kDa	Human	WB500-1:2000 IHC 1:50-1:200	200ug	59670
CLSDF2294	CD180 Antibody	90 kDa	Human	WB500-1:2000 IHC 1:50-1:200	200ug	59670
CLSDF2295	CD209 Antibody	44 kDa	Human, Mouse	WB500-1:2000	200ug	59670
CLSDF2296	CD27 Antibody	29 kDa	Human	WB500-1:2000 IHC 1:50-1:200	200ug	59670
CLSDF2297	CD276 Antibody	57 kDa	Human, Mouse, Rat	WB500-1:2000	200ug	59670
CLSDF2298	CD2AP antibody	74 kDa	Human, Mouse	WB500-1:2000	200ug	59670
CLSDF2301	CD40L Antibody	32 kDa	Human	WB500-1:2000 IHC 1:50-1:200	200ug	59670
CLSDF2302	CD48 Antibody	28 kDa	Human	WB500-1:2000 IHC 1:50-1:200	200ug	59670
CLSDF2303	CD59 Antibody	14 kDa	Human	WB500-1:2000 IHC 1:50-1:200	200ug	59670
CLSDF2304	CD5L Antibody	38 kDa	Human, Mouse	WB500-1:2000	200ug	59670
CLSDF2305	CD63 Antibody	26 kDa	Human, Mouse, Rat	WB500-1:2000	200ug	59670
CLSDF2306	CD81 Antibody	26 kDa	Human, Mouse, Rat	WB500-1:2000	200ug	59670
CLSDF2307	CD97 Antibody	92 kDa	Human	WB500-1:2000 IHC 1:50-1:200	200ug	59670
CLSDF2308	CDC42 Antibody	21 kDa	Human, Mouse, Rat	WB500-1:2000	200ug	59670

Antibodies
HSN : 38220090

Cat#	Product Description	MW	Reactivity	Application	Pack Size	Unit Price
CLSDF2309	CDK8 Antibody	53 kDa	Human, Mouse	WB500-1:2000	200ug	59670
CLSDF2310	CENPF Antibody	367 kDa	Human	WB500-1:2000 IHC 1:50-1:200	200ug	59670
CLSDF2311	CENPI Antibody	87 kDa	Human	WB500-1:2000 IHC 1:50-1:200	200ug	59670
CLSDF2312	CENPJ Antibody	149kDa	Human, Mouse	WB500-1:2000	200ug	59670
CLSDF2313	CENPL Antibody	39 kDa	Human	WB500-1:2000 IHC 1:50-1:200	200ug	59670
CLSDF2314	CENPM Antibody	20kDa	Human	WB500-1:2000 IHC 1:50-1:200	200ug	59670
CLSDF2315	CENPN Antibody	40 kDa	Human	WB500-1:2000 IHC 1:50-1:200	200ug	59670
CLSDF2316	CENPO Antibody	34 kDa	Human	WB500-1:2000 IHC 1:50-1:200	200ug	59670
CLSDF2317	CENPR Antibody	20 kDa	Human	WB500-1:2000 IHC 1:50-1:200	200ug	59670
CLSDF2318	CENPS Antibody	16 kDa	Human	WB500-1:2000 IHC 1:50-1:200	200ug	59670
CLSDF2319	CENPT Antibody	65 kDa	Human	WB500-1:2000 IHC 1:50-1:200	200ug	59670
CLSDF2320	CENPU Antibody	48 kDa	Human	WB500-1:2000 IHC 1:50-1:200	200ug	59670
CLSDF2321	CUL4A Antibody	88 kDa	Human, Mouse	WB500-1:2000	200ug	59670
CLSDF2322	CUL4B Antibody	99 kDa	Human, Mouse	WB500-1:2000	200ug	59670
CLSDF2323	CUL5 Antibody	91 kDa.	Human, Mouse, Rat	WB500-1:2000	200ug	59670
CLSDF2324	CUL7 Antibody	191 kDa	Human, Mouse	WB500-1:2000	200ug	59670
CLSDF2325	CX3CR1 Antibody	50 kDa	Human, Mouse, Rat	WB500-1:2000	200ug	59670
CLSDF2326	CXCR3 Antibody	41 kDa	Human, Mouse, Rat	WB500-1:2000	200ug	59670
CLSDF2327	CXCR5 Antibody	42 kDa	Human, Mouse, Rat	WB500-1:2000	200ug	59670
CLSDF2328	CXCR6 Antibody	44 kDa	Human, Mouse, Rat	WB500-1:2000	200ug	59670
CLSDF2329	CXCR7 Antibody	52 kDa	Human	WB500-1:2000 IHC 1:50-1:200	200ug	59670
CLSDF2330	CYLC1 Antibody	74 kDa	Human	WB500-1:2000 IHC 1:50-1:200	200ug	59670
CLSDF2331	CYLC2 Antibody	45 kDa	Human	WB500-1:2000 IHC 1:50-1:200	200ug	59670
CLSDF2332	FA58A Antibody		Human, Mouse, Rat	WB500-1:2000	200ug	59670
CLSDF2333	JIP4 Antibody	156.8 kDa	Human, Mouse	WB500-1:2000	200ug	59670
CLSDF2334	MAP3K12 Antibody	95 kDa	Human, Mouse, Rat	WB500-1:2000	200ug	59670
CLSDF2335	MAP3K14 Antibody	105.4 kDa	Human	WB500-1:2000 IHC 1:50-1:200	200ug	59670
CLSDF2336	MAP4K2 Antibody	91 kDa	Human	WB500-1:2000 IHC 1:50-1:200	200ug	59670
CLSDF2337	MAP4K5 Antibody	95 kDa	Human, Mouse	WB500-1:2000	200ug	59670
CLSDF2351	MAGD4 Antibody	81 kDa	Human	WB500-1:2000 IHC 1:50-1:200	200ug	59670
CLSDF2355	MAPK7 Antibody	115 kDa	Human, Mouse, Rat	WB500-1:2000	200ug	59670
CLSDF2356	MAPK8 Antibody	48 kDa	Human, Mouse, Rat	WB500-1:2000	200ug	59670
CLSDF2357	MAPK9 Antibody	54 kDa	Human, Mouse, Rat	WB500-1:2000	200ug	59670
CLSDF2358	MAPK11 Antibody	42 kDa	Human, Mouse	WB500-1:2000	200ug	59670
CLSDF2359	MAPK12 Antibody	42 kDa	Human, Mouse, Rat	WB500-1:2000	200ug	59670
CLSDF2360	MAPK13 Antibody	42 kDa	Human, Mouse, Rat	WB500-1:2000	200ug	59670
CLSDF2361	MK111 Antibody		Human, Mouse, Rat	WB500-1:2000	200ug	59670
CLSDF2362	MKNK2 Antibody	52 kDa	Human, Mouse, Rat	WB500-1:2000	200ug	59670
CLSDF2363	MORG1 Antibody	34 kDa	Human, Mouse, Rat	WB500-1:2000	200ug	59670
CLSDF2364	RAD1 Antibody	32 kDa	Human, Mouse	WB500-1:2000	200ug	59670
CLSDF2365	RAD9B Antibody	46 kDa	Human	WB500-1:2000 IHC 1:50-1:200	200ug	59670
CLSDF2366	SIVA Antibody	19 kDa	Human	WB500-1:2000 IHC 1:50-1:200	200ug	59670
CLSDF2367	TAB1 Antibody	55 kDa	Human, Mouse	WB500-1:2000	200ug	59670
CLSDF2368	TAB2 Antibody	76 kDa	Human, Mouse	WB500-1:2000	200ug	59670
CLSDF2369	TAB3 Antibody	79 kDa	Human, Mouse	WB500-1:2000	200ug	59670
CLSDF2370	ADCY3 Antibody	129 kDa	Human	WB500-1:2000 IHC 1:50-1:200	200ug	59670
CLSDF2371	ANAPC13 Antibody	8 kDa	Human, Mouse	WB500-1:2000	200ug	59670
CLSDF2372	MT-CYB Antibody	43 kDa	Human	WB500-1:2000 IHC 1:50-1:200	200ug	59670
CLSDF2373	TCEB1 Antibody	12 kDa	Human, Mouse, Rat	WB500-1:2000	200ug	59670
CLSDF2374	GADD45A Antibody	26 kDa	Human, Mouse	WB500-1:2000	200ug	59670
CLSDF2375	GADD45B Antibody	18 kDa	Human, Mouse, Rat	WB500-1:2000	200ug	59670
CLSDF2376	GADD45G Antibody	17 kDa	Human, Mouse, Rat	WB500-1:2000	200ug	59670
CLSDF2377	GZMK Antibody	34 kDa	Human	WB500-1:2000 IHC 1:50-1:200	200ug	59670

Antibodies
HSN : 38220090

Cat#	Product Description	MW	Reactivity	Application	Pack Size	Unit Price
CLSDF2378	GZMM Antibody	28 kDa	Human	WB500-1:2000 IHC 1:50-1:200	200ug	59670
CLSDF2379	EIF4G2 Antibody	102 kDa	Human, Mouse, Rat	WB500-1:2000	200ug	59670
CLSDF2380	LAMA5 Antibody		Human, Mouse	WB500-1:2000	200ug	59670
CLSDF2381	LAMB3 Antibody	130 kDa	Human, Mouse	WB500-1:2000	200ug	59670
CLSDF2382	LAMC3 Antibody		Human	WB500-1:2000 IHC 1:50-1:200	200ug	59670
CLSDF2383	LEG1 Antibody		Human, Mouse, Rat	WB500-1:2000	200ug	59670
CLSDF2384	LPPL Antibody		Human, Mouse	WB500-1:2000	200ug	59670
CLSDF2385	MSH3 Antibody	127 kDa	Human, Mouse	WB500-1:2000	200ug	59670
CLSDF2386	PARP4 Antibody	193 kDa	Human	WB500-1:2000 IHC 1:50-1:200	200ug	59670
CLSDF2387	PEA15 Antibody	15 kDa	Human, Mouse, Rat	WB500-1:2000	200ug	59670
CLSDF2388	PHLDA1 Antibody	45 kDa	Human, Mouse, Rat	WB500-1:2000	200ug	59670
CLSDF2389	PHLDA3 Antibody	14 kDa	Human, Mouse, Rat	WB500-1:2000	200ug	59670
CLSDF2390	PMS1 Antibody	105 kDa	Human	WB500-1:2000 IHC 1:50-1:200	200ug	59670
CLSDF2391	PMS2 Antibody	110 kDa	Human, Mouse	WB500-1:2000	200ug	59670
CLSDF2392	IFRD1 Antibody	50 kDa	Human, Mouse, Rat	WB500-1:2000	200ug	59670
CLSDF2393	KITH_HHV1K Antibody		Human	WB500-1:2000 IHC 1:50-1:200	200ug	59670
CLSDF2394	ISK7 Antibody		Human	WB500-1:2000 IHC 1:50-1:200	200ug	59670
CLSDF2395	CBF-C Antibody		Human	WB500-1:2000 IHC 1:50-1:200	200ug	59670
CLSDF2396	TBR1 Antibody	74 kDa	Human, Mouse	WB500-1:2000	200ug	59670
CLSDF2397	ZNF750 Antibody		Human, Mouse	WB500-1:2000	200ug	59670
CLSDF2398	MIBP1 Antibody	35,39 kDa	Human, Mouse, Rat	WB500-1:2000	200ug	59670
CLSDF2399	NR3C1 Antibody	86 kDa	Human	WB500-1:2000 IHC 1:50-1:200	200ug	59670
CLSDF2400	TIAL1 Antibody	41 kDa	Human, Mouse, Rat	WB500-1:2000	200ug	59670
CLSDF2401	TB10B Antibody		Human, Mouse	WB500-1:2000	200ug	59670
CLSDF2402	TAF1B Antibody	69 kDa	Human	WB500-1:2000 IHC 1:50-1:200	200ug	59670
CLSDF2403	TAF7L Antibody	42 kDa	Human	WB500-1:2000 IHC 1:50-1:200	200ug	59670
CLSDF2404	CA150 Antibody		Human	WB500-1:2000 IHC 1:50-1:200	200ug	59670
CLSDF2405			Human	WB500-1:2000 IHC 1:50-1:200	200ug	59670
CLSDF2406	NR5A1 Antibody	55 kDa	Human, Mouse, Rat	WB500-1:2000	200ug	59670
CLSDF2407	HES5 Antibody	18 kD	Human, Mouse, Rat	WB500-1:2000	200ug	59670
CLSDF2408	HES3 Antibody		Human, Mouse, Rat	WB500-1:2000	200ug	59670
CLSDF2409	GF11B Antibody	43 kDa	Human	WB500-1:2000 IHC 1:50-1:200	200ug	59670
CLSDF2410	Anti-ZNF660 antibody (ab85516) at 1 µg/ml (in 5% skim milk / PBS buffer) + HeLa cell lysate at 10 µg	38 kDa	Human	WB500-1:2000 IHC 1:50-1:200	200ug	59670
CLSDF2411	JHD3D Antibody	52 kDa	Human	WB500-1:2000 IHC 1:50-1:200	200ug	59670
CLSDF2412	TTC19 Antibody	35 kDa	Human, Mouse	WB500-1:2000	200ug	59670
CLSDF2413	MRCKG Antibody		Human	WB500-1:2000 IHC 1:50-1:200	200ug	59670
CLSDF2414	CRTC2 Antibody		Human, Mouse, Rat	WB500-1:2000	200ug	59670
CLSDF2415	CRTC1 Antibody	78 kDa	Human	WB500-1:2000 IHC 1:50-1:200	200ug	59670
CLSDF2416	ZNF497 Antibody		Human	WB500-1:2000 IHC 1:50-1:200	200ug	59670
CLSDF2417	JMJD1B Antibody	240 kDa	Human, Mouse	WB500-1:2000	200ug	59670
CLSDF2418	Antibody		Human	WB500-1:2000 IHC 1:50-1:200	200ug	59670
CLSDF2419	POGZ Antibody	155 kDa	Human	WB500-1:2000 IHC 1:50-1:200	200ug	59670
CLSDF2420	NUFIP2 Antibody	76 kDa	Human, Mouse	WB500-1:2000	200ug	59670
CLSDF2421	TFAP2D Antibody	50 kDa	Human, Mouse	WB500-1:2000	200ug	59670
CLSDF2422	ZSCAN2 Antibody		Human, Mouse	WB500-1:2000	200ug	59670
CLSDF2423	ZBTB33 Antibody	95 kDa	Human, Mouse	WB500-1:2000	200ug	59670
CLSDF2424	TAF15 Antibody	62 kDa	Human, Mouse	WB500-1:2000	200ug	59670
CLSDF2425	GKN2 Antibody		Human, Mouse, Rat	WB500-1:2000	200ug	59670
CLSDF2426	RB6I2 Antibody		Human, Mouse, Rat	WB500-1:2000	200ug	59670
CLSDF2427	AEBP1 Antibody		Human, Mouse, Rat	WB500-1:2000	200ug	59670
CLSDF2428	ZFPM1 Antibody	104 kDa	Human, Mouse	WB500-1:2000	200ug	59670
CLSDF2429	HOMEZ Antibody	58 kDa	Human, Mouse, Rat	WB500-1:2000	200ug	59670
CLSDF2430	MKX Antibody	39 kDa	Human, Mouse	WB500-1:2000	200ug	59670
CLSDF2431	SRRM1 Antibody	102 kDa	Human, Mouse	WB500-1:2000	200ug	59670

Antibodies
HSN : 38220090

Cat#	Product Description	MW	Reactivity	Application	Pack Size	Unit Price
CLSDF2432	ZNF440 Antibody	58 kDa	Human	WB500-1:2000 IHC 1:50-1:200	200ug	59670
CLSDF2433	XRN1 Antibody	194 kDa	Human, Mouse	WB500-1:2000	200ug	59670
CLSDF2434	MYOCD Antibody	100 kDa	Human, Mouse, Rat	WB500-1:2000	200ug	59670
CLSDF2435	CPXCR1 Antibody	35 kDa	Human	WB500-1:2000 IHC 1:50-1:200	200ug	59670
CLSDF2436	ZNF713 Antibody	59 kDa	Human	WB500-1:2000 IHC 1:50-1:200	200ug	59670
CLSDF2437	ZNF709 Antibody	75 kDa	Human	WB500-1:2000 IHC 1:50-1:200	200ug	59670
CLSDF2438	Max Antibody	34 kDa	Human, Mouse, Rat	WB500-1:2000	200ug	59670
CLSDF2439	DDB2 Antibody	45 kDa	Human, Mouse	WB500-1:2000	200ug	59670
CLSDF2440	SNAPC3 Antibody	38 kDa	Human	WB500-1:2000 IHC 1:50-1:200	200ug	59670
CLSDF2441	WNT8B Antibody	32 kDa	Human, Mouse	WB500-1:2000	200ug	59670
CLSDF2442	DIRC1 Antibody		Human	WB500-1:2000 IHC 1:50-1:200	200ug	59670
CLSDF2443	ARL11 Antibody	21 kDa	Human	WB500-1:2000 IHC 1:50-1:200	200ug	59670
CLSDF2444	E2F7 Antibody	99 kDa	Human	WB500-1:2000 IHC 1:50-1:200	200ug	59670
CLSDF2445	ZNF768 Antibody		Human	WB500-1:2000 IHC 1:50-1:200	200ug	59670
CLSDF2446	VSIG2 Antibody	34 kDa	Human	WB500-1:2000 IHC 1:50-1:200	200ug	59670
CLSDF2447	DMRTB1 Antibody	44 kDa	Human, Mouse	WB500-1:2000	200ug	59670
CLSDF2448	HEXIM2 Antibody	32 kDa	Human, Mouse	WB500-1:2000	200ug	59670
CLSDF2449	ALKBH3 Antibody	33 kDa	Human	WB500-1:2000 IHC 1:50-1:200	200ug	59670
CLSDF2450	BTBD14B Antibody	57 kDa	Human, Mouse, Rat	WB500-1:2000	200ug	59670
CLSDF2451	CITED4 Antibody	32 kDa	Human, Mouse, Rat	WB500-1:2000	200ug	59670
CLSDF2452	DIRC2 Antibody	52 kDa	Human, Mouse	WB500-1:2000	200ug	59670
CLSDF2453	ROAA Antibody		Human, Mouse, Rat	WB500-1:2000	200ug	59670
CLSDF2454	EBP2 Antibody	35 kDa	Human, Mouse	WB500-1:2000	200ug	59670
CLSDF2455	CITED2 Antibody	28 kDa	Human, Mouse, Rat	WB500-1:2000	200ug	59670
CLSDF2456	HOP Antibody	8 kDa	Human	WB500-1:2000 IHC 1:50-1:200	200ug	59670
CLSDF2457	TCHP Antibody	65 kDa	Human	WB500-1:2000 IHC 1:50-1:200	200ug	59670
CLSDF2458	DUSP26 Antibody	24 kDa	Human, Mouse, Rat	WB500-1:2000	200ug	59670
CLSDF2459	T106C Antibody		Human, Mouse, Rat	WB500-1:2000	200ug	59670
CLSDF2460	ZNF416 Antibody	67 kDa	Human	WB500-1:2000 IHC 1:50-1:200	200ug	59670
CLSDF2461	BACH2 Antibody	93 kDa	Human	WB500-1:2000 IHC 1:50-1:200	200ug	59670
CLSDF2462	CPEB1 Antibody	63 kDa	Human, Mouse, Rat	WB500-1:2000	200ug	59670
CLSDF2463	TRI31 Antibody		Human	WB500-1:2000 IHC 1:50-1:200	200ug	59670
CLSDF2464	BCL11B Antibody	95 kDa	Human	WB500-1:2000 IHC 1:50-1:200	200ug	59670
CLSDF2465	WWTR1 Antibody	44 kDa	Human, Mouse	WB500-1:2000	200ug	59670
CLSDF2466	TSYL2 Antibody		Human, Mouse	WB500-1:2000	200ug	59670
CLSDF2467	MIXL1 Antibody	25 kDa	Human, Mouse	WB500-1:2000	200ug	59670
CLSDF2468	FN3K Antibody	35 kDa	Human, Mouse	WB500-1:2000	200ug	59670
CLSDF2469	RBM35B Antibody	78 kDa	Human, Mouse	WB500-1:2000	200ug	59670
CLSDF2470	MANS1 Antibody		Human	WB500-1:2000 IHC 1:50-1:200	200ug	59670
CLSDF2471	MOBK1B Antibody	25 kDa	Human, Mouse, Rat	WB500-1:2000	200ug	59670
CLSDF2472	MED20 Antibody	23 kDa	Human, Mouse, Rat	WB500-1:2000	200ug	59670
CLSDF2473	SLC35C2 Antibody	40 kDa	Human	WB500-1:2000 IHC 1:50-1:200	200ug	59670
CLSDF2474	ZNF71 Antibody	54 kDa	Human	WB500-1:2000 IHC 1:50-1:200	200ug	59670
CLSDF2475	TOPRS Antibody		Human, Mouse	WB500-1:2000	200ug	59670
CLSDF2476	VSX1 Antibody	38 kDa	Human, Mouse	WB500-1:2000	200ug	59670
CLSDF2477	L36mt Antibody	12 kDa.	Human, Mouse	WB500-1:2000	200ug	59670
CLSDF2478	HNF-6 Antibody	51 kDa	Human, Mouse, Rat	WB500-1:2000	200ug	59670
CLSDF2479	BIN2 Antibody	62 kDa	Human	WB500-1:2000 IHC 1:50-1:200	200ug	59670
CLSDF2480	TrpRS Antibody	23 kDa	Human, Mouse	WB500-1:2000	200ug	59670
CLSDF2481	HSPB8 Antibody	22 kDa	Human, Mouse, Rat	WB500-1:2000	200ug	59670
CLSDF2482	INT6 Antibody	117 kDa	Human, Mouse	WB500-1:2000	200ug	59670
CLSDF2483	TNF18 Antibody	72 kDa	Human	WB500-1:2000 IHC 1:50-1:200	200ug	59670

Antibodies
HSN : 38220090

Cat#	Product Description	MW	Reactivity	Application	Pack Size	Unit Price
CLSDF2484	ABCG2 Antibody	72 kDa	Human	WB500-1:2000 IHC 1:50-1:200	200ug	59670
CLSDF2485	RRP7 Antibody	32 kDa	Human, Mouse, Rat	WB500-1:2000	200ug	59670
CLSDF2486	TMEM184B Antibody	46 kDa	Human, Mouse	WB500-1:2000	200ug	59670
CLSDF2487	TSSC4 Antibody		Human, Mouse, Rat	WB500-1:2000	200ug	59670
CLSDF2488	CYB5B Antibody		Human	WB500-1:2000 IHC 1:50-1:200	200ug	59670
CLSDF2489	DNAJB6 Antibody	36 kDa	Human, Mouse, Rat	WB500-1:2000	200ug	59670
CLSDF2490	DOT1L Antibody	185 kDa.	Human, Mouse, Rat	WB500-1:2000	200ug	59670
CLSDF2491	EHMT1 Antibody	170 kDa	Human, Mouse	WB500-1:2000	200ug	59670
CLSDF2492	FAIM1 Antibody	20 kDa	Human	WB500-1:2000 IHC 1:50-1:200	200ug	59670
CLSDF2493	FGF12 Antibody	27 kDa	Human, Mouse, Rat	WB500-1:2000	200ug	59670
CLSDF2494	FGF14 Antibody	28 kDa	Human, Mouse, Rat	WB500-1:2000	200ug	59670
CLSDF2495	FGF17 Antibody	25 kDa	Human, Mouse, Rat	WB500-1:2000	200ug	59670
CLSDF2496	FGF5 Antibody	30 kDa	Human, Mouse, Rat	WB500-1:2000	200ug	59670
CLSDF2497	FGF8 Antibody	25 kDa	Human, Mouse, Rat	WB500-1:2000	200ug	59670
CLSDF2498	FGFP1 Antibody		Human	WB500-1:2000 IHC 1:50-1:200	200ug	59670
CLSDF2499	GBP2 Antibody	67 kDa	Human	WB500-1:2000 IHC 1:50-1:200	200ug	59670
CLSDF2500	GRIP1 Antibody	117 kDa	Human, Mouse, Rat	WB500-1:2000	200ug	59670
CLSDF2501	HSPA12A Antibody	75 kDa	Human, Mouse	WB500-1:2000	200ug	59670
CLSDF2502	HSPA12B Antibody	76 kDa	Human, Mouse	WB500-1:2000	200ug	59670
CLSDF2503	HSPA4L Antibody	94 kDa	Human, Mouse	WB500-1:2000	200ug	59670
CLSDF2504	HSP77/76 Antibody		Human	WB500-1:2000 IHC 1:50-1:200	200ug	59670
CLSDF2505	HSPB3 Antibody		Human	WB500-1:2000 IHC 1:50-1:200	200ug	59670
CLSDF2506	HSPB7 Antibody	19 kDa	Human, Mouse	WB500-1:2000	200ug	59670
CLSDF2507	HSPB9 Antibody	17 kDa	Human	WB500-1:2000 IHC 1:50-1:200	200ug	59670
CLSDF2508	IL12RB1 Antibody	73 kDa	Human	WB500-1:2000 IHC 1:50-1:200	200ug	59670
CLSDF2509	IL12RB2 Antibody	75 kDa	Human, Mouse	WB500-1:2000	200ug	59670
CLSDF2510	IL17RB Antibody	49 kDa	Human, Mouse	WB500-1:2000	200ug	59670
CLSDF2511	IL17RD Antibody	80 kDa	Human, Mouse	WB500-1:2000	200ug	59670
CLSDF2512	IGFBPL1 Antibody	29 kDa	Human, Mouse	WB500-1:2000	200ug	59670
CLSDF2513	IFITM1 Antibody	14 kDa	Human	WB500-1:2000 IHC 1:50-1:200	200ug	59670
CLSDF2514	IFNA2 Antibody		Human	WB500-1:2000 IHC 1:50-1:200	200ug	59670
CLSDF2515	IFNA4 Antibody	22 kDa	Human	WB500-1:2000 IHC 1:50-1:200	200ug	59670
CLSDF2516	IGF2 Antibody	20 kDa	Human, Mouse, Rat	WB500-1:2000	200ug	59670
CLSDF2517	IGFL1 Antibody		Human	WB500-1:2000 IHC 1:50-1:200	200ug	59670
CLSDF2518	IL11 Antibody	27 kDa	Human, Mouse, Rat	WB500-1:2000	200ug	59670
CLSDF2519	IL12B Antibody	46 kDa	Human	WB500-1:2000 IHC 1:50-1:200	200ug	59670
CLSDF2520	IL13 Antibody	16 kDa	Human	WB500-1:2000 IHC 1:50-1:200	200ug	59670
CLSDF2521	IL15 Antibody	18 kDa	Human	WB500-1:2000 IHC 1:50-1:200	200ug	59670
CLSDF2522	IL16 Antibody	142 kDa	Human	WB500-1:2000 IHC 1:50-1:200	200ug	59670
CLSDF2523	IL1F5 Antibody	17 kDa	Human, Mouse	WB500-1:2000	200ug	59670
CLSDF2524	IL1F6 Antibody	25 kDa	Human	WB500-1:2000 IHC 1:50-1:200	200ug	59670
CLSDF2525	IL1F8 Antibody	17 kDa	Human	WB500-1:2000 IHC 1:50-1:200	200ug	59670
CLSDF2526	IL1FA Antibody		Human, Mouse	WB500-1:2000	200ug	59670
CLSDF2527	IL20 Antibody	20 kDa	Human, Mouse	WB500-1:2000	200ug	59670
CLSDF2528	IL25 Antibody	20 kDa	Human	WB500-1:2000 IHC 1:50-1:200	200ug	59670
CLSDF2529	IL5RA Antibody	48 kDa	Human, Mouse	WB500-1:2000	200ug	59670
CLSDF2530	IL6RA Antibody	51 kDa	Human	WB500-1:2000 IHC 1:50-1:200	200ug	59670
CLSDF2531	IL7 Antibody	20 kDa	Human	WB500-1:2000 IHC 1:50-1:200	200ug	59670
CLSDF2532	IL9 Antibody	16 kDa	Human	WB500-1:2000 IHC 1:50-1:200	200ug	59670
CLSDF2533	IL1RL1 Antibody	70 kDa	Human	WB500-1:2000 IHC 1:50-1:200	200ug	59670
CLSDF2534	IN35 Antibody	32 kDa	Human	WB500-1:2000 IHC 1:50-1:200	200ug	59670

Antibodies
HSN : 38220090

Cat#	Product Description	MW	Reactivity	Application	Pack Size	Unit Price
CLSDF2535	INAR2 Antibody		Human	WB500-1:2000 IHC 1:50-1:200	200ug	59670
CLSDF2536	INSL6 Antibody	25 kDa	Human	WB500-1:2000 IHC 1:50-1:200	200ug	59670
CLSDF2537	ISL1 Antibody	39 kDa	Human, Mouse, Rat	WB500-1:2000	200ug	59670
CLSDF2538	ITGA1 Antibody	131 kDa	Human, Mouse, Rat	WB500-1:2000	200ug	59670
CLSDF2539	ITGA10 Antibody	128 kDa	Human, Mouse	WB500-1:2000	200ug	59670
CLSDF2540	ITGA2 Antibody	150 kDa	Human	WB500-1:2000 IHC 1:50-1:200	200ug	59670
CLSDF2541	ITGAM Antibody	170 kDa	Human	WB500-1:2000 IHC 1:50-1:200	200ug	59670
CLSDF2542	ITGAX Antibody	150 kDa	Human	WB500-1:2000 IHC 1:50-1:200	200ug	59670
CLSDF2543	ITGB6 Antibody	86 kDa	Human, Mouse, Rat	WB500-1:2000	200ug	59670
CLSDF2544	ITGB7 Antibody	87 kDa	Human	WB500-1:2000 IHC 1:50-1:200	200ug	59670
CLSDF2545	ITGB8 Antibody	81 kDa	Human, Mouse	WB500-1:2000	200ug	59670
CLSDF2546	ITBP1 Antibody		Human, Mouse	WB500-1:2000	200ug	59670
CLSDF2547	JAD1B Antibody		Human, Mouse	WB500-1:2000	200ug	59670
CLSDF2548	JAD1D Antibody		Human	WB500-1:2000 IHC 1:50-1:200	200ug	59670
CLSDF2549	JAM1 Antibody	33 kDa	Human, Mouse, Rat	WB500-1:2000	200ug	59670
CLSDF2550	JAM2 Antibody	33 kDa	Human, Mouse, Rat	WB500-1:2000	200ug	59670
CLSDF2551	JAML1 Antibody		Human	WB500-1:2000 IHC 1:50-1:200	200ug	59670
CLSDF2552	KRT36 Antibody	52 kDa	Human	WB500-1:2000 IHC 1:50-1:200	200ug	59670
CLSDF2553	KRT31/33A/33B Antibody	47 kDa//46 kDa//46 kDa	Human	WB500-1:2000 IHC 1:50-1:200	200ug	59670
CLSDF2554	K2C1 Antibody		Human, Mouse	WB500-1:2000	200ug	59670
CLSDF2555	K2C1B Antibody		Human	WB500-1:2000 IHC 1:50-1:200	200ug	59670
CLSDF2556	K2C6B/C Antibody		Human	WB500-1:2000 IHC 1:50-1:200	200ug	59670
CLSDF2557	KRT82 Antibody	57 kDa	Human, Mouse	WB500-1:2000	200ug	59670
CLSDF2558	KRT85/86 Antibody	56 kDa//54kDa	Human, Mouse	WB500-1:2000	200ug	59670
CLSDF2559	KRT81 Antibody	55 kDa.	Human	WB500-1:2000 IHC 1:50-1:200	200ug	59670
CLSDF2560	MCF2 Antibody	108 kDa	Human, Mouse	WB500-1:2000	200ug	59670
CLSDF2561	PDCD1LG2 Antibody	31 kDa	Human, Mouse	WB500-1:2000	200ug	59670
CLSDF2562	PDCD5 Antibody	18 kDa	Human, Mouse	WB500-1:2000	200ug	59670
CLSDF2563	PAK1IP1 Antibody	48 kDa	Human	WB500-1:2000 IHC 1:50-1:200	200ug	59670
CLSDF2564	PLCB4 Antibody		Human, Mouse, Rat	WB500-1:2000	200ug	59670
CLSDF2565	PLCE1 Antibody		Human	WB500-1:2000 IHC 1:50-1:200	200ug	59670
CLSDF2566	SETDB2 Antibody	120 kDa	Human	WB500-1:2000 IHC 1:50-1:200	200ug	59670
CLSDF2567	SAP130 Antibody	135 kDa	Human, Mouse	WB500-1:2000	200ug	59670
CLSDF2568	TUBD1 Antibody	45 kDa	Human	WB500-1:2000 IHC 1:50-1:200	200ug	59670
CLSDF2569	TINP1 Antibody	30 kDa	Human, Mouse, Rat	WB500-1:2000	200ug	59670
CLSDF2570	ANAPC4 Antibody	92 kDa	Human, Mouse, Rat	WB500-1:2000	200ug	59670
CLSDF2571	CNNM1 Antibody	72kDa	Human, Mouse	WB500-1:2000	200ug	59670
CLSDF2572	CNNM3 Antibody	48 kDa	Human	WB500-1:2000 IHC 1:50-1:200	200ug	59670
CLSDF2573	KIF23 Antibody	89 kDa	Human	WB500-1:2000 IHC 1:50-1:200	200ug	59670
CLSDF2574	MCM9 Antibody	Isoform 1, 127 ; Isoform 2, 44 kDa	Human	WB500-1:2000 IHC 1:50-1:200	200ug	59670
CLSDF2575	STRN1/3 Antibody		Human, Mouse, Rat	WB500-1:2000	200ug	59670
CLSDF2576	MAPRE2 Antibody	37 kDa	Human, Mouse, Rat	WB500-1:2000	200ug	59670
CLSDF2577	SYCP1 Antibody	114 kDa	Human	WB500-1:2000 IHC 1:50-1:200	200ug	59670
CLSDF2578	SYCP2 Antibody	45 kDa	Human	WB500-1:2000 IHC 1:50-1:200	200ug	59670
CLSDF2579	SYCP3 Antibody	28 kDa	Human, Mouse	WB500-1:2000	200ug	59670
CLSDF2580	NKIRAS2 Antibody	22 kDa	Human, Mouse	WB500-1:2000	200ug	59670
CLSDF2581	REV1 Antibody	138 kDa	Human	WB500-1:2000 IHC 1:50-1:200	200ug	59670
CLSDF2582	CREB3L3 Antibody	49 kDa	Human, Mouse, Rat	WB500-1:2000	200ug	59670
CLSDF2583	MIB2 Antibody	110 kDa	Human, Mouse, Rat	WB500-1:2000	200ug	59670
CLSDF2584	ALKBH4 Antibody	36 kDa	Human, Mouse	WB500-1:2000	200ug	59670
CLSDF2585	ALKBH5 Antibody	44 kDa	Human, Mouse	WB500-1:2000	200ug	59670
CLSDF2586	BCL7B Antibody	22 kDa	Human, Mouse	WB500-1:2000	200ug	59670

Antibodies
HSN : 38220090

Cat#	Product Description	MW	Reactivity	Application	Pack Size	Unit Price
CLSDF2587	BCL7C Antibody	23 kDa	Human, Mouse	WB500-1:2000	200ug	59670
CLSDF2588	CC2D1A Antibody	130 kDa	Human, Mouse, Rat	WB500-1:2000	200ug	59670
CLSDF2589	MUL1 Antibody	38 kDa	Human, Mouse	WB500-1:2000	200ug	59670
CLSDF2590	CANT1 Antibody	45 kDa	Human, Mouse	WB500-1:2000	200ug	59670
CLSDF2591	E2F8 Antibody	94 kDa	Human	WB500-1:2000 IHC 1:50-1:200	200ug	59670
CLSDF2592	HNF4A/G Antibody	53 kDa//46 kDa	Human, Mouse, Rat	WB500-1:2000	200ug	59670
CLSDF2593	KLF12 Antibody	44 kDa	Human, Mouse	WB500-1:2000	200ug	59670
CLSDF2594	KLF14 Antibody	31kDa	Human, Mouse	WB500-1:2000	200ug	59670
CLSDF2595	NFE2 Antibody	41 kDa	Human, Mouse, Rat	WB500-1:2000	200ug	59670
CLSDF2596	NDFIP2 Antibody	36 kDa	Human	WB500-1:2000 IHC 1:50-1:200	200ug	59670
CLSDF2597	SLC35B2 Antibody	48 kDa	Human, Mouse	WB500-1:2000	200ug	59670
CLSDF2598	SMARCAD1 Antibody	117 kDa	Human	WB500-1:2000 IHC 1:50-1:200	200ug	59670
CLSDF2599	SP5/8/9 Antibody	42 kDa//48 kDa	Human, Mouse	WB500-1:2000	200ug	59670
CLSDF2600	ZDHHC13 Antibody	58 kDa	Human	WB500-1:2000 IHC 1:50-1:200	200ug	59670
CLSDF2601	ZDHHC17 Antibody	73 kDa	Human, Mouse, Rat	WB500-1:2000	200ug	59670
CLSDF2602	POU2AF1 Antibody	35 kDa	Human, Mouse	WB500-1:2000	200ug	59670
CLSDF2603	ORC5 Antibody	50 kDa	Human, Mouse	WB500-1:2000	200ug	59670
CLSDF2604	PAX1 Antibody	55 kDa	Human	WB500-1:2000 IHC 1:50-1:200	200ug	59670
CLSDF2605	PAX4 Antibody	42 kDa	Human, Mouse, Rat	WB500-1:2000	200ug	59670
CLSDF2606	PAX8 Antibody	60 kDa	Human, Mouse, Rat	WB500-1:2000	200ug	59670
CLSDF2607	PKNOX1 Antibody	42 kDa	Human, Mouse, Rat	WB500-1:2000	200ug	59670
CLSDF2608	POU3F2 Antibody	47 kDa	Human, Mouse, Rat	WB500-1:2000	200ug	59670
CLSDF2609	PROP1 Antibody	25 kDa	Human, Mouse	WB500-1:2000	200ug	59670
CLSDF2610	SOX4 Antibody	47 kDa	Human, Mouse	WB500-1:2000	200ug	59670
CLSDF2611	ZBTB16 Antibody	85 kDa	Human, Mouse, Rat	WB500-1:2000	200ug	59670
CLSDF2612	Cytochrome P450 7A1 Antibody	58 kDa	Human	WB500-1:2000 IHC 1:50-1:200	200ug	59670
CLSDF2613	Cytochrome P450 reductase Antibody	78 kDa	Human, Mouse, Rat	WB500-1:2000	200ug	59670
CLSDF2614	Cytochrome P450 4F12 Antibody	60 kDa	Human	WB500-1:2000 IHC 1:50-1:200	200ug	59670
CLSDF2615	Cytochrome P450 2J2 Antibody	58 kDa	Human	WB500-1:2000 IHC 1:50-1:200	200ug	59670
CLSDF2616	Cytochrome P450 3A43 Antibody		Human	WB500-1:2000 IHC 1:50-1:200	200ug	59670
CLSDF2617	Cytochrome P450 3A43 Antibody		Human	WB500-1:2000 IHC 1:50-1:200	200ug	59670
CLSDF2618	Cytochrome P450 3A4 Antibody	52 kDa	Human	WB500-1:2000 IHC 1:50-1:200	200ug	59670
CLSDF2619	C9orf156 Antibody	49 kDa	Human	WB500-1:2000 IHC 1:50-1:200	200ug	59670
CLSDF2620	Cytochrome P450 3A43 Antibody		Human	WB500-1:2000 IHC 1:50-1:200	200ug	59670
CLSDF2621	Cytochrome P450 17A1 Antibody	60 kDa	Human	WB500-1:2000 IHC 1:50-1:200	200ug	59670
CLSDF2622	SIRT1 Antibody	110 kDa	Human, Mouse	WB500-1:2000	200ug	59670
CLSDF2623	PIK3C2A Antibody	191 kDa	Human, Mouse	WB500-1:2000	200ug	59670
CLSDF2624	PIK3C2B Antibody	185 kDa	Human	WB500-1:2000 IHC 1:50-1:200	200ug	59670
CLSDF2625	PIK3CA Antibody	110 kDa	Human, Mouse	WB500-1:2000	200ug	59670
CLSDF2626	PIK3CB Antibody	110 kDa	Human, Mouse, Rat	WB500-1:2000	200ug	59670
CLSDF2627	PIK3CD Antibody	110 kDa	Human, Mouse	WB500-1:2000	200ug	59670
CLSDF2628	HUWE1 Antibody	481 kDa	Human, Mouse	WB500-1:2000	200ug	59670
CLSDF2629	PIK3R3 Antibody	54 kDa	Human, Mouse, Rat	WB500-1:2000	200ug	59670
CLSDF2630	DYNLL1 Antibody	10 kDa	Human, Mouse, Rat	WB500-1:2000	200ug	59670
CLSDF2631	ATR Antibody	300 kDa	Human	WB500-1:2000 IHC 1:50-1:200	200ug	59670
CLSDF2632	ATRNB Antibody	159 kDa	Human	WB500-1:2000 IHC 1:50-1:200	200ug	59670
CLSDF2633	ING2 Antibody	33 kDa	Human, Mouse	WB500-1:2000	200ug	59670
CLSDF2634	ING5 Antibody	28 kDa	Human, Mouse	WB500-1:2000	200ug	59670
CLSDF2635	ING4 Antibody	29 kDa	Human, Mouse, Rat	WB500-1:2000	200ug	59670
CLSDF2636	ING1 Antibody	47 kDa	Human, Mouse, Rat	WB500-1:2000	200ug	59670
CLSDF2637	ING3 Antibody	50 kDa	Human, Mouse, Rat	WB500-1:2000	200ug	59670
CLSDF2638	MAP2K7 Antibody	47 kDa	Human, Mouse, Rat	WB500-1:2000	200ug	59670
CLSDF2639	HRB Antibody	58 kDa	Human, Mouse, Rat	WB500-1:2000	200ug	59670
CLSDF2640	NRIP1 Antibody	150 kDa	Human	WB500-1:2000 IHC 1:50-1:200	200ug	59670
CLSDF2641	RIPK2 Antibody	60 kDa	Human, Mouse, Rat	WB500-1:2000	200ug	59670

Antibodies
HSN : 38220090

Cat#	Product Description	MW	Reactivity	Application	Pack Size	Unit Price
CLSDF2642	RIPK1 Antibody	76 kDa	Human	WB500-1:2000 IHC 1:50-1:200	200ug	59670
CLSDF2643	CIRBP Antibody	18 kDa	Human, Mouse, Rat	WB500-1:2000	200ug	59670
CLSDF2644	RASAL2 Antibody	129 kDa	Human, Mouse	WB500-1:2000	200ug	59670
CLSDF2645	RASA1 Antibody	110 kDa	Human, Mouse, Rat	WB500-1:2000	200ug	59670
CLSDF2646	RASEF Antibody	83 kDa	Human, Mouse	WB500-1:2000	200ug	59670
CLSDF2647	RASA2 Antibody		Human, Mouse, Rat	WB500-1:2000	200ug	59670
CLSDF2648	NCOA1 Antibody	200 kDa	Human, Mouse, Rat	WB500-1:2000	200ug	59670
CLSDF2649	BCL2L13 Antibody	50 kDa	Human	WB500-1:2000 IHC 1:50-1:200	200ug	59670
CLSDF2650	BAG2 Antibody	24 kDa	Human, Mouse, Rat	WB500-1:2000	200ug	59670
CLSDF2651	FGF19 Antibody	24 kDa	Human	WB500-1:2000 IHC 1:50-1:200	200ug	59670
CLSDF2652	MAGEB5 Antibody	32 kDa	Human	WB500-1:2000 IHC 1:50-1:200	200ug	59670
CLSDF2653	ACTA1/A2/C1 Antibody	42 kDa	Human, Mouse, Rat	WB500-1:2000	200ug	59670
CLSDF2654	AKT3 Antibody	56 kDa	Human, Mouse, Rat	WB500-1:2000	200ug	59670
CLSDF2655	POMC Antibody	29 kDa	Human, Mouse, Rat	WB500-1:2000	200ug	59670
CLSDF2656	PRKAA2 Antibody	60 kDa Exposure time : 2 hours	Human, Mouse, Rat	WB500-1:2000	200ug	59670
CLSDF2657	BUB1B Antibody	119 kDa	Human, Mouse, Rat	WB500-1:2000	200ug	59670
CLSDF2658	MYLK3 Antibody	88 kDa	Human, Mouse, Rat	WB500-1:2000	200ug	59670
CLSDF2659	PTK7 Antibody	86 kDa	Human, Mouse	WB500-1:2000	200ug	59670
CLSDF2660	CCRK Antibody	39 kDa	Human, Mouse, Rat	WB500-1:2000	200ug	59670
CLSDF2661	CSNK2A2 Antibody	41 kDa	Human, Mouse	WB500-1:2000	200ug	59670
CLSDF2662	CLK3 Antibody	59 kDa	Human, Mouse, Rat	WB500-1:2000	200ug	59670
CLSDF2663	DDR2 Antibody	97 kDa	Human, Mouse, Rat	WB500-1:2000	200ug	59670
CLSDF2664	STK17A Antibody	47 kDa	Human	WB500-1:2000 IHC 1:50-1:200	200ug	59670
CLSDF2665	DYRK4 Antibody	60 kDa	Human	WB500-1:2000 IHC 1:50-1:200	200ug	59670
CLSDF2666	EPHA4 Antibody	125 kDa	Human, Mouse	WB500-1:2000	200ug	59670
CLSDF2667	IRAK4 Antibody	51 kDa	Human	WB500-1:2000 IHC 1:50-1:200	200ug	59670
CLSDF2668	LRRK2 Antibody	286 kDa	Human, Mouse	WB500-1:2000	200ug	59670
CLSDF2669	NEK2 Antibody	52 kDa	Human	WB500-1:2000 IHC 1:50-1:200	200ug	59670
CLSDF2670	NRK Antibody	178 kDa	Human, Mouse	WB500-1:2000	200ug	59670
CLSDF2671	NUAK2 Antibody	70 kDa	Human	WB500-1:2000 IHC 1:50-1:200	200ug	59670
CLSDF2672	PCTK1 Antibody	56 kDa	Human, Mouse, Rat	WB500-1:2000	200ug	59670
CLSDF2673	PCTK3 Antibody	54 kDa	Human, Mouse, Rat	WB500-1:2000	200ug	59670
CLSDF2674	PRKD3 Antibody	107 kDa	Human, Mouse, Rat	WB500-1:2000	200ug	59670
CLSDF2675	PRKCH Antibody	78 kDa	Human, Mouse, Rat	WB500-1:2000	200ug	59670
CLSDF2676	PRKCI Antibody	68 kDa	Human, Mouse, Rat	WB500-1:2000	200ug	59670
CLSDF2677	PRKG1 Antibody	76 kDa	Human, Mouse	WB500-1:2000	200ug	59670
CLSDF2678	PKN3 Antibody	99, 112, 104 kDa	Human, Mouse	WB500-1:2000	200ug	59670
CLSDF2679	SGK3 Antibody	57 kDa	Human, Mouse, Rat	WB500-1:2000	200ug	59670
CLSDF2680	TYRO3 Antibody	97 kDa	Human, Mouse, Rat	WB500-1:2000	200ug	59670
CLSDF2681	SNRK Antibody	84 kDa	Human, Mouse, Rat	WB500-1:2000	200ug	59670
CLSDF2682	SRMS Antibody	65 kDa	Human	WB500-1:2000 IHC 1:50-1:200	200ug	59670
CLSDF2683	TAOK2 Antibody	120 kDa	Human, Mouse, Rat	WB500-1:2000	200ug	59670
CLSDF2684	TNK1 Antibody	72 kDa	Human, Mouse	WB500-1:2000	200ug	59670
CLSDF2685	TRIO Antibody	31 kDa	Human, Mouse	WB500-1:2000	200ug	59670
CLSDF2686	TSSK3 Antibody	30 kDa	Human, Mouse, Rat	WB500-1:2000	200ug	59670
CLSDF2687	TTBK1 Antibody	143 kDa	Human, Mouse	WB500-1:2000	200ug	59670
CLSDF2688	TTBK2 Antibody	137 kDa	Human, Mouse	WB500-1:2000	200ug	59670
CLSDF2689	VEGFR3 Antibody	50 kDa	Human	WB500-1:2000 IHC 1:50-1:200	200ug	59670
CLSDF2690	VRK2 Antibody	58 kDa	Human	WB500-1:2000 IHC 1:50-1:200	200ug	59670
CLSDF2691	SGK494 Antibody	31 kDa	Human, Mouse	WB500-1:2000	200ug	59670
CLSDF2692	TRIB2 Antibody	36 kDa	Human, Mouse	WB500-1:2000	200ug	59670
CLSDF2693	Histone H2B Antibody	14 kDa	Human, Mouse, Rat	WB500-1:2000	200ug	59670
CLSDF2694	CEACAM3 Antibody	27 kDa	Human	WB500-1:2000 IHC 1:50-1:200	200ug	59670

Antibodies
HSN : 38220090

Cat#	Product Description	MW	Reactivity	Application	Pack Size	Unit Price
CLSDF2695	ATG9A Antibody	94 kDa	Human, Mouse, Rat	WB500-1:2000	200ug	59670
CLSDF2696	BECN1L1 Antibody		Human	WB500-1:2000 IHC 1:50-1:200	200ug	59670
CLSDF2697	IL27A Antibody	39,51 kDa	Human, Mouse	WB500-1:2000	200ug	59670
CLSDF2698	HSPA1A Antibody	72 kDa	Human, Mouse	WB500-1:2000	200ug	59670
CLSDF2699	NKX2-5 Antibody	50 kDa	Human, Mouse, Rat	WB500-1:2000	200ug	59670
CLSDF2700	PRDX1 Antibody	22 kDa	Human, Mouse, Rat	WB500-1:2000	200ug	59670
CLSDF2701	PAEP Antibody	21 kDa	Human	WB500-1:2000 IHC 1:50-1:200	200ug	59670
CLSDF2702	LRRN1 Antibody	73 kDa	Human, Mouse, Rat	WB500-1:2000	200ug	59670
CLSDF2703	KLK12 Antibody	27 kDa	Human	WB500-1:2000 IHC 1:50-1:200	200ug	59670
CLSDF2704	KLK6 Antibody	30 kDa	Human	WB500-1:2000 IHC 1:50-1:200	200ug	59670
CLSDF2705	Lys proteins Antibody		Human, Mouse, Rat	WB500-1:2000	200ug	59670
CLSDF2706	HTR1D Antibody	45 kDa	Human, Mouse, Rat	WB500-1:2000	200ug	59670
CLSDF2707	HTR3A Antibody	55 kDa	Human	WB500-1:2000 IHC 1:50-1:200	200ug	59670
CLSDF2708	HTR3E Antibody		Human	WB500-1:2000 IHC 1:50-1:200	200ug	59670
CLSDF2709	ADRB1 Antibody	51 kDa	Human, Mouse, Rat	WB500-1:2000	200ug	59670
CLSDF2710	CCR1 Antibody	37.6 kDa	Human	WB500-1:2000 IHC 1:50-1:200	200ug	59670
CLSDF2711	CCR2 Antibody	42 kDa	Mouse, Rat	WB500-1:2000 IHC 1:50-1:200	200ug	59670
CLSDF2712	CMKLR1 Antibody	42 kDa	Human	WB500-1:2000 IHC 1:50-1:200	200ug	59670
CLSDF2713	DRD5 Antibody	53 kDa	Human	WB500-1:2000 IHC 1:50-1:200	200ug	59670
CLSDF2714	EDG8 Antibody	41 kDa Exposure time : 8 minutes	Human	WB500-1:2000 IHC 1:50-1:200	200ug	59670
CLSDF2715	OR51A1P Antibody	35 kDa	Human	WB500-1:2000 IHC 1:50-1:200	200ug	59670
CLSDF2716	OR52Z1P Antibody	35 kDa	Human	WB500-1:2000 IHC 1:50-1:200	200ug	59670
CLSDF2717	HOR5Beta8 Antibody		Human	WB500-1:2000 IHC 1:50-1:200	200ug	59670
CLSDF2718	HOR5Beta13 Antibody		Human	WB500-1:2000 IHC 1:50-1:200	200ug	59670
CLSDF2719	FPRL1 Antibody	38 kDa	Human	WB500-1:2000 IHC 1:50-1:200	200ug	59670
CLSDF2720	GPR1 Antibody	38 kDa	Human	WB500-1:2000 IHC 1:50-1:200	200ug	59670
CLSDF2721	GPR12 Antibody	50 kDa	Human, Mouse, Rat	WB500-1:2000	200ug	59670
CLSDF2722	GPR128 Antibody	89 kDa	Human	WB500-1:2000 IHC 1:50-1:200	200ug	59670
CLSDF2723	GPR133 Antibody	97 for isoform 1 , for isoform 2, 61 kDa	Human	WB500-1:2000 IHC 1:50-1:200	200ug	59670
CLSDF2724	GPR136 Antibody	40 kDa	Human, Mouse	WB500-1:2000	200ug	59670
CLSDF2725	GPR146 Antibody	30 kDa	Human	WB500-1:2000 IHC 1:50-1:200	200ug	59670
CLSDF2726	GPR148 Antibody	61 kDa	Human	WB500-1:2000 IHC 1:50-1:200	200ug	59670
CLSDF2727	GPR15 Antibody	50 kDa	Human, Mouse	WB500-1:2000	200ug	59670
CLSDF2728	GPR161 Antibody	65 kDa	Human	WB500-1:2000 IHC 1:50-1:200	200ug	59670
CLSDF2729	GPR19 Antibody	48 kDa	Human, Mouse, Rat	WB500-1:2000	200ug	59670
CLSDF2730	GPR20 Antibody	42 kDa	Human	WB500-1:2000 IHC 1:50-1:200	200ug	59670
CLSDF2731	GPR21 Antibody	40 kDa	Human, Mouse	WB500-1:2000	200ug	59670
CLSDF2732	GPR22 Antibody	49 kDa	Human, Mouse	WB500-1:2000	200ug	59670
CLSDF2733	GPR25 Antibody	39 kDa	Human, Mouse	WB500-1:2000	200ug	59670
CLSDF2734	GPR26 Antibody	38 kDa	Human, Mouse, Rat	WB500-1:2000	200ug	59670
CLSDF2735	GPR27 Antibody	40 kDa	Human, Mouse, Rat	WB500-1:2000	200ug	59670
CLSDF2736	GPR3 Antibody	35 kDa	Human, Mouse, Rat	WB500-1:2000	200ug	59670
CLSDF2737	GPR30 Antibody	42 kDa	Human, Mouse, Rat	WB500-1:2000	200ug	59670
CLSDF2738	GPR31 Antibody	35 kDa	Human	WB500-1:2000 IHC 1:50-1:200	200ug	59670
CLSDF2739	GPR32 Antibody	33 kDa	Human	WB500-1:2000 IHC 1:50-1:200	200ug	59670
CLSDF2740	GPR34 Antibody	44 kDa	Human, Mouse, Rat	WB500-1:2000	200ug	59670

Antibodies
HSN : 38220090

Cat#	Product Description	MW	Reactivity	Application	Pack Size	Unit Price
CLSDF2741	GPR35 Antibody	34 kDa	Human, Mouse	WB500-1:2000	200ug	59670
CLSDF2742	GPR37 Antibody	67 kDa	Human, Mouse, Rat	WB500-1:2000	200ug	59670
CLSDF2743	GPR39 Antibody	51 kDa	Human	WB500-1:2000 IHC 1:50-1:200	200ug	59670
CLSDF2744	GPR4 Antibody	41 kDa	Human, Mouse, Rat	WB500-1:2000	200ug	59670
CLSDF2745	GPR40 Antibody	28 kDa	Human, Mouse, Rat	WB500-1:2000	200ug	59670
CLSDF2746	GPR43 Antibody	37 kDa	Human	WB500-1:2000 IHC 1:50-1:200	200ug	59670
CLSDF2747	GPR44 Antibody	66 kDa	Human	WB500-1:2000 IHC 1:50-1:200	200ug	59670
CLSDF2748	GPR45 Antibody	42 kDa	Human, Mouse	WB500-1:2000	200ug	59670
CLSDF2749	GPR48 Antibody	104 kDa	Human, Mouse, Rat	WB500-1:2000	200ug	59670
CLSDF2750	GPR52 Antibody	41 kDa	Human, Mouse	WB500-1:2000	200ug	59670
CLSDF2751	GPR54 Antibody	42 kDa	Human	WB500-1:2000 IHC 1:50-1:200	200ug	59670
CLSDF2752	GPR55 Antibody	37kDa	Human	WB500-1:2000 IHC 1:50-1:200	200ug	59670
CLSDF2753	GPR56 Antibody	78 kDa	Human	WB500-1:2000 IHC 1:50-1:200	200ug	59670
CLSDF2754	GPR6 Antibody	38 kDa	Human, Mouse, Rat	WB500-1:2000	200ug	59670
CLSDF2755	GPR61 Antibody	49 kDa	Human, Mouse	WB500-1:2000	200ug	59670
CLSDF2756	GPR62 Antibody	38 kDa	Human, Mouse	WB500-1:2000	200ug	59670
CLSDF2757	GPR63 Antibody	48 kDa	Human, Mouse	WB500-1:2000	200ug	59670
CLSDF2758	GPR64 Antibody	112 kDa	Human, Mouse, Rat	WB500-1:2000	200ug	59670
CLSDF2759	GPR68 Antibody	41 kDa	Human, Mouse	WB500-1:2000	200ug	59670
CLSDF2760	GPR7 Antibody	36 kDa	Human	WB500-1:2000 IHC 1:50-1:200	200ug	59670
CLSDF2761	GPR75 Antibody	59 kDa	Human, Mouse	WB500-1:2000	200ug	59670
CLSDF2762	GPR77 Antibody	36 kDa	Human	WB500-1:2000 IHC 1:50-1:200	200ug	59670
CLSDF2763	GPR78 Antibody	39 kDa	Human	WB500-1:2000 IHC 1:50-1:200	200ug	59670
CLSDF2764	GPR8 Antibody	37 kDa	Human	WB500-1:2000 IHC 1:50-1:200	200ug	59670
CLSDF2765	GPR80/GPR99 Antibody	38 kDa	Human, Mouse, Rat	WB500-1:2000	200ug	59670
CLSDF2766	GPR81 Antibody	39 kDa	Human, Mouse	WB500-1:2000	200ug	59670
CLSDF2767	GPR82 Antibody	38 kDa	Human, Mouse	WB500-1:2000	200ug	59670
CLSDF2768	GPR83/GPR72 Antibody	48 kDa	Human, Mouse	WB500-1:2000	200ug	59670
CLSDF2769	GPR84 Antibody	38 kDa	Human	WB500-1:2000 IHC 1:50-1:200	200ug	59670
CLSDF2770	GPR86/GPR94 Antibody	41 kDa	Human	WB500-1:2000 IHC 1:50-1:200	200ug	59670
CLSDF2771	GPR87/GPR95 Antibody	44 kDa	Human, Mouse	WB500-1:2000	200ug	59670
CLSDF2772	GPR89A Antibody	53 kDa	Human, Mouse	WB500-1:2000	200ug	59670
CLSDF2773	GPR91 Antibody	38 kDa	Human	WB500-1:2000 IHC 1:50-1:200	200ug	59670
CLSDF2774	GPR92/GPR93 Antibody	Predicted band size : 41 kDa Observed band size : 41 kDa	Human	WB500-1:2000 IHC 1:50-1:200	200ug	59670
CLSDF2775	GPR97 Antibody	61 kDa	Human	WB500-1:2000 IHC 1:50-1:200	200ug	59670
CLSDF2776	EBI2 Antibody	41 kDa	Human	WB500-1:2000 IHC 1:50-1:200	200ug	59670
CLSDF2777	SS2R Antibody	55 kDa Exposure time : 6 minutes	Human, Mouse, Rat	WB500-1:2000	200ug	59670
CLSDF2778	SS3R Antibody	46 kDa	Human	WB500-1:2000 IHC 1:50-1:200	200ug	59670
CLSDF2779	SS4R Antibody	42 kDa	Human	WB500-1:2000 IHC 1:50-1:200	200ug	59670
CLSDF2780	SS5R Antibody	42 kDa	Human	WB500-1:2000 IHC 1:50-1:200	200ug	59670
CLSDF2781	CHRM3 Antibody	85 kDa	Human, Mouse, Rat	WB500-1:2000	200ug	59670
CLSDF2782	C5ARL Antibody	46 kDa	Human	WB500-1:2000 IHC 1:50-1:200	200ug	59670

Antibodies
HSN : 38220090

Cat#	Product Description	MW	Reactivity	Application	Pack Size	Unit Price
CLSDF2783	CXCR2 Antibody	41 kDa	Human	WB500-1:2000 IHC 1:50-1:200	200ug	59670
CLSDF2784	EBI2 Antibody	41 kDa	Human, Mouse	WB500-1:2000	200ug	59670
CLSDF2785	EDG1 Antibody	43 kDa	Human	WB500-1:2000 IHC 1:50-1:200	200ug	59670
CLSDF2786	EDG2 Antibody	39 kDa	Human, Mouse, Rat	WB500-1:2000	200ug	59670
CLSDF2787	EDG8 Antibody	41 kDa	Human, Mouse, Rat	WB500-1:2000	200ug	59670
CLSDF2788	EDNRB Antibody	50 kDa	Human, Mouse, Rat	WB500-1:2000	200ug	59670
CLSDF2789	EMR1 Antibody	102 kDa	Human	WB500-1:2000 IHC 1:50-1:200	200ug	59670
CLSDF2790	FZD10 Antibody	65 kDa	Human, Mouse	WB500-1:2000	200ug	59670
CLSDF2791	FZD2 Antibody	32 kDa	Human, Mouse, Rat	WB500-1:2000	200ug	59670
CLSDF2792	GPR137B Antibody	46 kDa	Human, Mouse	WB500-1:2000	200ug	59670
CLSDF2793	GASR Antibody	48 kDa	Human	WB500-1:2000 IHC 1:50-1:200	200ug	59670
CLSDF2794	GHSR Antibody	41 kDa	Human, Mouse, Rat	WB500-1:2000	200ug	59670
CLSDF2795	GNRHR2 Antibody	42 kDa	Human	WB500-1:2000 IHC 1:50-1:200	200ug	59670
CLSDF2796	GPR110 Antibody	101 kDa	Human	WB500-1:2000 IHC 1:50-1:200	200ug	59670
CLSDF2797	GPR141 Antibody	35 kDa	Human, Mouse, Rat	WB500-1:2000	200ug	59670
CLSDF2798	GPR161 Antibody	65 kDa	Human	WB500-1:2000 IHC 1:50-1:200	200ug	59670
CLSDF2799	GPR162 Antibody	64 kDa	Human, Mouse	WB500-1:2000	200ug	59670
CLSDF2800	GPR176 Antibody	57 kDa	Human, Mouse, Rat	WB500-1:2000	200ug	59670
CLSDF2801	GPR1 Antibody	41 kDa	Human, Mouse, Rat	WB500-1:2000	200ug	59670
CLSDF2802	GPR21 Antibody	40 kDa	Human, Mouse	WB500-1:2000	200ug	59670
CLSDF2803	GPR26 Antibody	38 kDa	Human, Mouse, Rat	WB500-1:2000	200ug	59670
CLSDF2804	GPR33 Antibody	50 kDa	Human	WB500-1:2000 IHC 1:50-1:200	200ug	59670
CLSDF2805	GPR39 Antibody	51 kDa	Human	WB500-1:2000 IHC 1:50-1:200	200ug	59670
CLSDF2806	GPR4 Antibody	41 kDa	Human, Mouse, Rat	WB500-1:2000	200ug	59670
CLSDF2807	GPR44 Antibody	43 kDa	Human, Mouse	WB500-1:2000	200ug	59670
CLSDF2808	GPR45 Antibody	42 kDa	Human, Mouse	WB500-1:2000	200ug	59670
CLSDF2809	GPR55 Antibody	37kDa	Human	WB500-1:2000 IHC 1:50-1:200	200ug	59670
CLSDF2810	GPR61 Antibody	49 kDa	Human, Mouse	WB500-1:2000	200ug	59670
CLSDF2811	GPR84 Antibody	38 kDa	Human	WB500-1:2000 IHC 1:50-1:200	200ug	59670
CLSDF2812	GPR88 Antibody	40 kDa	Human, Mouse, Rat	WB500-1:2000	200ug	59670
CLSDF2813	GPR97 Antibody	61 kDa	Human	WB500-1:2000 IHC 1:50-1:200	200ug	59670
CLSDF2814	GRM6 Antibody	95 kDa	Human, Mouse, Rat	WB500-1:2000	200ug	59670
CLSDF2815	GRPR Antibody	53 kDa	Human, Mouse, Rat	WB500-1:2000	200ug	59670
CLSDF2816	LGR5 Antibody	100 kDa	Human, Mouse	WB500-1:2000	200ug	59670
CLSDF2817	LPHN3 Antibody	120 kDa	Human, Mouse, Rat	WB500-1:2000	200ug	59670
CLSDF2818	MAS Antibody	37 kDa	Human, Mouse, Rat	WB500-1:2000	200ug	59670
CLSDF2819	MCHR1 Antibody	46 kDa	Human, Mouse, Rat	WB500-1:2000	200ug	59670
CLSDF2820	MRGRD Antibody	41 kDa 10 % SDS-PAGE	Human	WB500-1:2000 IHC 1:50-1:200	200ug	59670
CLSDF2821	NMUR2 Antibody	46 kDa	Human	WB500-1:2000 IHC 1:50-1:200	200ug	59670
CLSDF2822	NPSR1 Antibody	43 kDa	Human, Mouse, Rat	WB500-1:2000	200ug	59670
CLSDF2823	NPY4R Antibody	42 kDa	Human	WB500-1:2000 IHC 1:50-1:200	200ug	59670
CLSDF2824	OR2A12 Antibody	35 kDa	Human	WB500-1:2000 IHC 1:50-1:200	200ug	59670
CLSDF2825	OR2T8/2T12/2T33 Antibody	35 kDa/36 kDa	Human	WB500-1:2000 IHC 1:50-1:200	200ug	59670
CLSDF2826	OR4C45 Antibody	35 kDa	Human	WB500-1:2000 IHC 1:50-1:200	200ug	59670
CLSDF2827	OR4F3/4F21 Antibody	35 kDa/35 kDa	Human	WB500-1:2000 IHC 1:50-1:200	200ug	59670
CLSDF2828	OR51L1 Antibody	35 kDa	Human	WB500-1:2000 IHC 1:50-1:200	200ug	59670
CLSDF2829	OR51M1 Antibody	35 kDa	Human	WB500-1:2000 IHC 1:50-1:200	200ug	59670
CLSDF2830	OR5AN1 Antibody	35 kDa	Human	WB500-1:2000 IHC 1:50-1:200	200ug	59670

Antibodies
HSN : 38220090

Cat#	Product Description	MW	Reactivity	Application	Pack Size	Unit Price
CLSDF2831	OR5H6/5H14 Antibody	37 kDa	Human	WB500-1:2000 IHC 1:50-1:200	200ug	59670
CLSDF2832	OR6C75 Antibody	30 kDa	Human	WB500-1:2000 IHC 1:50-1:200	200ug	59670
CLSDF2833	OR7E24 Antibody	38 kDa	Human	WB500-1:2000 IHC 1:50-1:200	200ug	59670
CLSDF2834	OPRL1 Antibody	41 kDa	Human, Mouse, Rat	WB500-1:2000	200ug	59670
CLSDF2835	OR10Q1 Antibody		Human	WB500-1:2000 IHC 1:50-1:200	200ug	59670
CLSDF2836	OR1F1 Antibody	35 kDa	Human	WB500-1:2000 IHC 1:50-1:200	200ug	59670
CLSDF2837	OR1G1 Antibody		Human	WB500-1:2000 IHC 1:50-1:200	200ug	59670
CLSDF2838	OR1I1 Antibody	39 kDa	Human	WB500-1:2000 IHC 1:50-1:200	200ug	59670
CLSDF2839	OR1J1 Antibody		Human	WB500-1:2000 IHC 1:50-1:200	200ug	59670
CLSDF2840	OR1J4 Antibody	35 kDa	Human	WB500-1:2000 IHC 1:50-1:200	200ug	59670
CLSDF2841	OR1J2/1N2 Antibody	37 kDa	Human	WB500-1:2000 IHC 1:50-1:200	200ug	59670
CLSDF2842	OR1L1 Antibody	41 kDa	Human	WB500-1:2000 IHC 1:50-1:200	200ug	59670
CLSDF2843	OR1L3 Antibody	37 kDa	Human	WB500-1:2000 IHC 1:50-1:200	200ug	59670
CLSDF2844	OR1L4/1L6 Antibody	35 kDa/40 kDa	Human	WB500-1:2000 IHC 1:50-1:200	200ug	59670
CLSDF2845	OR2A12 Antibody	35 kDa	Human	WB500-1:2000 IHC 1:50-1:200	200ug	59670
CLSDF2846	OR2A2 Antibody		Human	WB500-1:2000 IHC 1:50-1:200	200ug	59670
CLSDF2847	OR2H1 Antibody		Human	WB500-1:2000 IHC 1:50-1:200	200ug	59670
CLSDF2848	OR2L3/2L8 Antibody		Human	WB500-1:2000 IHC 1:50-1:200	200ug	59670
CLSDF2849	OR2L3/2L8 Antibody		Human	WB500-1:2000 IHC 1:50-1:200	200ug	59670
CLSDF2850	OR2M4 Antibody	35 kDa	Human	WB500-1:2000 IHC 1:50-1:200	200ug	59670
CLSDF2851	OR2S2 Antibody	35 kDa	Human	WB500-1:2000 IHC 1:50-1:200	200ug	59670
CLSDF2852	OR2T27 Antibody	36 kDa	Human	WB500-1:2000 IHC 1:50-1:200	200ug	59670
CLSDF2853	OR2T6 Antibody	35 kDa	Human	WB500-1:2000 IHC 1:50-1:200	200ug	59670
CLSDF2854	OR2V1 Antibody		Human	WB500-1:2000 IHC 1:50-1:200	200ug	59670
CLSDF2855	OR2V2 Antibody	35 kDa	Human	WB500-1:2000 IHC 1:50-1:200	200ug	59670
CLSDF2856	OR2W1 Antibody	36 kDa	Human	WB500-1:2000 IHC 1:50-1:200	200ug	59670
CLSDF2857	OR3A1 Antibody	35 kDa	Human	WB500-1:2000 IHC 1:50-1:200	200ug	59670
CLSDF2858	RGR Antibody	32 kDa	Human	WB500-1:2000 IHC 1:50-1:200	200ug	59670
CLSDF2859	PJCG2 Antibody		Human	WB500-1:2000 IHC 1:50-1:200	200ug	59670
CLSDF2900	Alas1 Antibody	71kDa	Human	WB ICC/IF	200ug	59670
CLSDF2901	alpha Tubulin 4A Antibody	50kDa	Human Mouse Rat	WB IHC ICC/IF	200ug	59670
CLSDF2902	ARRB1 Antibody	50kDa	Human Mouse Rat	WB IHC ICC/IF	200ug	59670
CLSDF2903	Bcl6 Antibody	78kDa	Human	WB IHC ICC/IF	200ug	59670
CLSDF2904	beta I Tubulin Antibody	50kDa	Human Mouse Rat Cow Dog Monkey	WB IHC ICC/IF	200ug	59670
CLSDF2905	Brd4 Antibody	152kDa	Human Mouse Rat	WB IHC ICC/IF	200ug	59670
CLSDF2906	C10orf63 Antibody	29kDa	Human Mouse	WB	200ug	59670
CLSDF2907	CaMKII Antibody	45,60 kDa	Human Mouse Rat	WB IHC ICC/IF	200ug	59670
CLSDF2908	Caspase-2 Antibody	48,30,12kDa	Human Mouse Rat	WB IHC ICC/IF	200ug	59670
CLSDF2909	CCL19 Antibody	11kDa	Human	WB	200ug	59670
CLSDF2910	CCR9 Antibody	45kDa	Human Mouse Rat	WB ICC	200ug	59670
CLSDF2911	CD11b Antibody Antibody	kDa	Human Mouse	WB IHC ICC/IF	200ug	59670
CLSDF2912	CD45 Antibody	150kDa	Human	WB IHC	200ug	59670
CLSDF2913	Collagen XVII Antibody	130,180kDa	Human Mouse Rat	WB IHC ICC/IF	200ug	59670
CLSDF2914	Cubilin Antibody	399kDa	Human	WB IHC	200ug	59670
CLSDF2915	Cubilin Antibody	399kDa	Human Mouse Rat	WB	200ug	59670
CLSDF2916	Cytokeratin 19 Antibody	40kDa	Human Mouse	WB IHC ICC/IF	200ug	59670
CLSDF2917	DGCR8 Antibody	100kDa	Human Mouse Rat	WB ICC/IF	200ug	59670

Antibodies
HSN : 38220090

Cat#	Product Description	MW	Reactivity	Application	Pack Size	Unit Price
CLSDF2918	DNAJC15 Antibody	16kDa	Human Mouse Rat	WB IHC	200ug	59670
CLSDF2919	DUSP6 Antibody	42kDa	Human Mouse Rat	WB IHC ICC/IF	200ug	59670
CLSDF2920	ENO1 Antibody	47kDa	Human Mouse Rat	WB ICC/IF	200ug	59670
CLSDF2923	Flotillin 1 Antibody	48kDa	Human Mouse Rat	WB IHC	200ug	59670
CLSDF2924	FUBP1 Antibody	74kDa	Human Mouse Rat	WB IHC ICC/IF	200ug	59670
CLSDF2925	GATA2/3 Antibody	51kDa	Human Mouse Rat	WB IHC ICC/IF	200ug	59670
CLSDF2926	HAPLN1 Antibody	48kDa	Human Mouse Rat	WB IHC ICC/IF	200ug	59670
CLSDF2927	HDAC11 Antibody	39kDa	Human	WB	200ug	59670
CLSDF2928	HIF-2-alpha Antibody	96kDa	Human Mouse Rat	WB ICC/IF	200ug	59670
CLSDF2929	Histone H2A (acetyl K9) Antibody	14kDa	Human Mouse Rat	WB IHC ICC/IF	200ug	59670
CLSDF2930	Histone H2A.Z Antibody	13kDa	Human Mouse Rat	WB IHC ICC/IF	200ug	59670
CLSDF2931	Histone H3 (mono+di+tri methyl K14) Antibody	15kDa	Human Mouse	WB ICC/IF	200ug	59670
CLSDF2932	Id1 Antibody	22kDa	Human Mouse Rat	WB IHC ICC/IF	200ug	59670
CLSDF2933	KDEL Antibody	78kDa	Human Mouse Rat	WB IHC ICC/IF	200ug	59670
CLSDF2934	KIFC1 Antibody	74kDa	Human	WB IHC ICC/IF	200ug	59670
CLSDF2935	LRP1 Antibody	85kDa	Human Mouse Rat	WB IHC ICC/IF	200ug	59670
CLSDF2936	Lrp2 / Megalin Antibody	280kDa	Human Mouse Rat	WB	200ug	59670
CLSDF2939	MHC class 1 Antibody	41kDa	Human	WB IHC ICC/IF	200ug	59670
CLSDF2940	Myb Antibody	80kDa,72kDa	Human	WB IHC ICC/IF	200ug	59670
CLSDF2941	Otx1 Antibody	37kDa	Human Mouse Rat	WB	200ug	59670
CLSDF2942	pan Cadherin Antibody	140kDa	Human Mouse Rat	WB IHC ICC/IF	200ug	59670
CLSDF2943	PD1 Antibody	32kDa	Human	IHC	200ug	59670
CLSDF2944	Phospho-Cdk1/2 (T14) Antibody	34kDa	Human Mouse Rat	WB IHC	200ug	59670
CLSDF2945	Phospho-eIF4E (S209) antibody	25kDa	Human Mouse Rat	WB IHC ICC	200ug	59670
CLSDF2946	Phospho-Histone H1.3 (T17) +H1.4 (T17) Antibody	30kDa	Human Mouse Rat	WB IHC ICC/IF	200ug	59670
CLSDF2947	Phospho-HSF1 (S326) Antibody	82kDa	Human	WB IHC ICC	200ug	59670
CLSDF2948	Phospho-PAK1/2/3 (S144+S141+S139) Antibody	65kDa	Human Mouse Rat	WB IHC ICC/IF	200ug	59670
CLSDF2949	Phospho-RSK1 p90 (T359+S363) Antibody	90kDa	Human Mouse Rat	WB IHC ICC	200ug	59670
CLSDF2950	Phospho-Smad5 (S463/465) Antibody	58kDa	Human Mouse Rat	WB IHC ICC	200ug	59670
CLSDF2951	PI 3 Kinase p85 beta Antibody	82kDa	Human Rat	WB IHC ICC/IF	200ug	59670
CLSDF2952	PKC alpha Antibody	75kDa	Human Mouse Rat	WB IHC ICC/IF	200ug	59670
CLSDF2953	PMEL17 / GP100 Antibody	100kDa	Human	WB IHC	200ug	59670
CLSDF2954	PPP1CA + 1CB Antibody	37kDa	Human Mouse Rat	WB IHC ICC	200ug	59670
CLSDF2955	PRC1 Antibody	72kDa	Human Mouse Rat	WB IHC ICC/IF	200ug	59670
CLSDF2956	PTBP2 Antibody	57kDa	Human Mouse Rat	WB IHC ICC/IF	200ug	59670
CLSDF2957	Rab9 Antibody	23kDa	Human Mouse Rat	WB ICC/IF	200ug	59670
CLSDF2958	Renilla Luciferase Antibody	36kDa	Renilla Luciferase	WB ICC/IF	200ug	59670
CLSDF2959	Rho A + B + C Antibody	24kDa	Human Mouse Rat	WB IHC ICC/IF	200ug	59670
CLSDF2960	RNF20 Antibody	114kDa	Human Mouse	WB ICC/IF	200ug	59670
CLSDF2961	RNF20 Antibody	114kDa	Human Mouse	WB ICC/IF	200ug	59670
CLSDF2962	SATB2 Antibody	81kDa	Human Mouse Rat	WB IHC ICC/IF	200ug	59670
CLSDF2963	SNF5 Antibody	44kDa	Human Mouse Rat	WB	200ug	59670
CLSDF2964	UCLH3 Antibody	26kDa	Human Mouse Rat	WB	200ug	59670
CLSDF2965	V5 tag Antibody	N/A	All	WB	200ug	59670
CLSDF2966	VSV-G tag Antibody	N/A	All	WB	200ug	59670
CLSDF2967	YB1 Antibody	50kDa	Human Mouse Rat	WB IHC ICC/IF	200ug	59670
CLSDF3001	JMY Antibody	130 KD	Human, Mouse	WB	200ug	59670
CLSDF3002	NKX6.3 Antibody	34 KD	Human, Mouse	WB IF/ICC	200ug	59670
CLSDF3003	PDLIM1 Antibody	36 KD	Human, Mouse,Rat	WB IHC IF/ICC	200ug	59670
CLSDF3004	TAF4 Antibody	110 KD	Human, Mouse	WB	200ug	59670
CLSDF3005	CDC7 Antibody	70 KD	Human	WB	200ug	59670
CLSDF3006	TTF2 Antibody	34 KD	Human, Mouse,Rat	WB	200ug	59670
CLSDF3007	LHR2A Antibody	86 KD	Human	WB	200ug	59670
CLSDF3008	TRIM38 Antibody	53 KD	Human, Mouse	WB	200ug	59670
CLSDF3009	TP53I11 Antibody	18 KD	Human	WB IHC	200ug	59670
CLSDF3010	OVOL1 Antibody	33 KD	Human, Mouse	WB	200ug	59670
CLSDF3011	KNTC2 Antibody	73 KD	Human, Mouse	WB IF/ICC	200ug	59670
CLSDF3012	TNFSF11 Antibody	40 KD	Human, Mouse	WB IF/ICC	200ug	59670
CLSDF3013	BCKD Antibody	46 KD	Human, Mouse,Rat	WB IF/ICC	200ug	59670
CLSDF3014	KLF11 Antibody	55 KD	Human, Mouse	WB	200ug	59670
CLSDF3015	HGS Antibody	86 KD	Human, Mouse,Rat	WB IHC IF/ICC	200ug	59670
CLSDF3016	EPHB6 Antibody	119 KD	Human, Mouse,Rat	WB IHC IF/ICC	200ug	59670
CLSDF3017	TRI18 Antibody	75 KD	Human, Mouse,Rat	WB IHC IF/ICC	200ug	59670
CLSDF3018	GSC2 Antibody	25 KD	Human, Mouse	WB	200ug	59670
CLSDF3019	Clock Antibody	95 KD	Human, Mouse,Rat	WB IHC	200ug	59670
CLSDF3020	PHF1 Antibody	62 KD	Human, Mouse,Rat	WB	200ug	59670
CLSDF3021	ANP32C Antibody	26 KD	Human	WB	200ug	59670
CLSDF3022	TBX1 Antibody	43 KD	Human	WB IF/ICC	200ug	59670

Antibodies

HSN : 38220090

Cat#	Product Description	MW	Reactivity	Application	Pack Size	Unit Price
CLSDF3023	TNF12 Antibody	27 KD	Human, Mouse	WB IHC IF/ICC	200ug	59670
CLSDF3024	AKAP10 Antibody	73 KD	Human, Mouse,Rat	WB	200ug	59670
CLSDF3025	AKAP8 Antibody	76 KD	Human, Mouse,Rat	WB IHC IF/ICC	200ug	59670
CLSDF3026	AIRE Antibody	60 KD	Human, Mouse	WB IF/ICC	200ug	59670
CLSDF3027	EFNA2 Antibody	24 KD	Human, Mouse	WB	200ug	59670
CLSDF3028	ZNF387 Antibody	115 KD	Human	WB	200ug	59670
CLSDF3029	DLX3 Antibody	45 KD	Human, Mouse	WB IHC	200ug	59670
CLSDF3030	ZIC1/2/3 Antibody	51 KD	Human, Mouse	WB IHC	200ug	59670
CLSDF3031	hnRNP Q Antibody	62 KD	Human, Mouse,Rat	WB IF/ICC	200ug	59670
CLSDF3032	SDCG1 Antibody	123 KD	Human, Mouse,Rat	WB	200ug	59670
CLSDF3033	BUB1B Antibody	130 KD	Human, Mouse	WB	200ug	59670
CLSDF3034	LMX1B Antibody	40 KD	Human, Mouse	WB	200ug	59670
CLSDF3035	Musculin Antibody	22 KD	Human, Mouse	WB IHC	200ug	59670
CLSDF3036	PFKFB2 Antibody	58 KD	Human, Mouse	WB	200ug	59670
CLSDF3037	Dyskerin Antibody	57 KD	Human, Mouse,Rat	WB IF/ICC	200ug	59670
CLSDF3038	PFDN1 Antibody	14 KD	Human, Mouse	WB	200ug	59670
CLSDF3039	TBX10 Antibody	43 KD	Human	WB	200ug	59670
CLSDF3040	TRIM3 Antibody	81 KD	Human, Mouse,Rat	WB IHC IF/ICC	200ug	59670
CLSDF3041	LAT3 Antibody	61 KD	Human	WB	200ug	59670
CLSDF3042	TACC1 Antibody	87 KD	Human, Mouse	WB IF/ICC	200ug	59670
CLSDF3043	Maf Antibody	41 KD	Human, Mouse,Rat	WB	200ug	59670
CLSDF3044	MED24 Antibody	110 KD	Human, Mouse,Rat	WB IF/ICC	200ug	59670
CLSDF3045	SUPT3H Antibody	50 KD	Human	WB	200ug	59670
CLSDF3046	TAF5L Antibody	66 KD	Human	WB	200ug	59670
CLSDF3047	Caper Antibody	39 KD	Human, Mouse,Rat	WB IHC IF/ICC	200ug	59670
CLSDF3048	BCAR3 Antibody	92 KD	Human	WB IHC	200ug	59670
CLSDF3049	TALL-2 Antibody	23 KD	Human, Mouse,Rat	WB IHC IF/ICC	200ug	59670
CLSDF3050	TUSC2 Antibody	12 KD	Human, Mouse	WB	200ug	59670
CLSDF3051	DGKI Antibody	160 KD	Human,Rat	WB IF/ICC	200ug	59670
CLSDF3052	ALX3 Antibody	36 KD	Human, Mouse,Rat	WB IF/ICC	200ug	59670
CLSDF3053	TNFSF15 Antibody	20 KD	Human	WB IF/ICC	200ug	59670
CLSDF3054	ZNF265 Antibody	34 KD	Human, Mouse,Rat	WB IF/ICC	200ug	59670
CLSDF3055	LRAT Antibody	27 KD	Human, Mouse,Rat	WB IHC IF/ICC	200ug	59670
CLSDF3056	MYST2 Antibody	75 KD	Human, Mouse,Rat	WB IF/ICC	200ug	59670
CLSDF3057	MED26 Antibody	65 KD	Human, Mouse	WB	200ug	59670
CLSDF3058	TNFRSF6B Antibody	32 KD	Human	WB IHC IF/ICC	200ug	59670
CLSDF3059	SIX6 Antibody	28 KD	Human, Mouse,Rat	WB IF/ICC	200ug	59670
CLSDF3060	CBX6 Antibody	44 KD	Human, Mouse,Rat	WB	200ug	59670
CLSDF3061	GAS41 Antibody	40 KD	Human, Mouse	WB	200ug	59670
CLSDF3062	ZNF682 Antibody	58 KD	Human	WB	200ug	59670
CLSDF3063	MEKKK 4 Antibody	142 KD	Human, Mouse	WB IF/ICC	200ug	59670
CLSDF3064	TOP3B Antibody	96 KD	Human, Mouse	WB	200ug	59670
CLSDF3065	PTTG1 Antibody	30 KD	Human	WB IF/ICC	200ug	59670
CLSDF3066	ACTL6A Antibody	47 KD	Human, Mouse,Rat	WB IF/ICC	200ug	59670
CLSDF3067	MOS Antibody	40 KD	Human	WB	200ug	59670
CLSDF3068	ALDOA Antibody	39 KD	Human, Mouse,Rat	WB	200ug	59670
CLSDF3069	KITH Antibody	25 KD	Human	WB	200ug	59670
CLSDF3070	HMG17 Antibody	0 KD	Human, Mouse,Rat	IHC IF/ICC	200ug	59670
CLSDF3071	CDC2 Antibody	34 KD	Human, Mouse,Rat	WB IF/ICC	200ug	59670
CLSDF3072	M-CK Antibody	43 KD	Human, Mouse,Rat	WB IHC IF/ICC	200ug	59670
CLSDF3073	Histone 1F0 Antibody	20 KD	Human	WB	200ug	59670
CLSDF3074	HEXB Antibody	63 KD	Human	WB IHC	200ug	59670
CLSDF3075	hnRNP C1/C2 Antibody	33 KD	Human, Mouse,Rat	WB IHC IF/ICC	200ug	59670
CLSDF3076	Adrenergic Receptor α -2A Antibody	48 KD	Human, Mouse,Rat	WB IHC IF/ICC	200ug	59670
CLSDF3077	HMGB1 Antibody	25 KD	Human, Mouse,Rat	WB	200ug	59670
CLSDF3078	HOXC6 Antibody	26 KD	Human, Mouse	WB	200ug	59670
CLSDF3079	hnRNP A1 Antibody	33 KD	Human, Mouse,Rat	WB IHC IF/ICC	200ug	59670
CLSDF3080	TACD2 Antibody	35 KD	Human, Mouse,Rat	WB	200ug	59670
CLSDF3081	FGR Antibody	55 KD	Human, Mouse,Rat	WB	200ug	59670
CLSDF3082	DNA Polymerase α Antibody	165 KD	Human	WB	200ug	59670
CLSDF3083	Histone H2AZ Antibody	0 KD	Human, Mouse,Rat	0	200ug	59670
CLSDF3084	HKR1 Antibody	73 KD	Human	WB IF/ICC	200ug	59670
CLSDF3085	NR2F6 Antibody	42 KD	Human, Mouse,Rat	WB IHC IF/ICC	200ug	59670
CLSDF3086	TOP2A Antibody	174 KD	Human	WB IHC IF/ICC	200ug	59670
CLSDF3087	HARS Antibody	60 52 KD	Human, Mouse	WB IF/ICC	200ug	59670
CLSDF3088	SKIL Antibody	77 KD	Human, Mouse	WB	200ug	59670
CLSDF3089	MYF5 Antibody	28 KD	Human, Mouse	WB	200ug	59670
CLSDF3090	TCTP Antibody	24 KD	Human, Mouse,Rat	WB IHC	200ug	59670
CLSDF3091	KAP2 Antibody	45 KD	Human	WB	200ug	59670



Antibodies

HSN : 38220090

Cat#	Product Description	MW	Reactivity	Application	Pack Size	Unit Price
CLSDF3092	GLU2B Antibody	59 KD	Human, Mouse	WB IF/ICC	200ug	59670
CLSDF3093	IRF2 Antibody	47 KD	Human, Mouse,Rat	WB IHC	200ug	59670
CLSDF3094	hnRNP L Antibody	60 KD	Human, Mouse	WB IHC IF/ICC	200ug	59670
CLSDF3095	B-RAF Antibody	62 KD	Human, Mouse	WB IHC IF/ICC	200ug	59670
CLSDF3096	Fra-1 Antibody	43 KD	Human, Mouse,Rat	WB	200ug	59670
CLSDF3097	TCF3 Antibody	68 KD	Human, Mouse,Rat	WB IHC	200ug	59670
CLSDF3098	PFKFB1 Antibody	58 KD	Human, Mouse,Rat	WB	200ug	59670
CLSDF3099	TACD1 Antibody	34 KD	Human	WB	200ug	59670
CLSDF3100	ZNF18 Antibody	62 KD	Human, Mouse,Rat	WB	200ug	59670
CLSDF3101	ZNF24 Antibody	48 KD	Human, Mouse,Rat	WB	200ug	59670
CLSDF3102	UBF1 Antibody	90 KD	Human, Mouse,Rat	WB IHC	200ug	59670
CLSDF3103	HOXB9 Antibody	28 KD	Human, Mouse	WB	200ug	59670
CLSDF3104	CKMT2 Antibody	48 KD	Human, Mouse,Rat	WB IF/ICC	200ug	59670
CLSDF3105	ATF7 Antibody	52 KD	Human, Mouse	WB	200ug	59670
CLSDF3106	KAPC A/B Antibody	38 KD	Human, Mouse,Rat	WB	200ug	59670
CLSDF3107	K6PL Antibody	85 KD	Human, Mouse,Rat	WB	200ug	59670
CLSDF3108	Adrenergic Receptor α-2C Antibody	70 KD	Human, Mouse,Rat	WB	200ug	59670
CLSDF3109	ATF1 Antibody	36 KD	Human, Mouse,Rat	WB IF/ICC	200ug	59670
CLSDF3110	ATF3 Antibody	21 KD	Human, Mouse,Rat	WB	200ug	59670
CLSDF3111	TSPAN8 Antibody	26 KD	Human	WB IF/ICC	200ug	59670
CLSDF3112	HXK1 Antibody	109 KD	Human, Mouse,Rat	WB	200ug	59670
CLSDF3113	TFEB Antibody	52 KD	Human, Mouse	WB IHC	200ug	59670
CLSDF3114	TFE3 Antibody	62 KD	Human, Mouse	WB IHC	200ug	59670
CLSDF3115	TBP Antibody	38 KD	Human, Mouse,Rat	WB	200ug	59670
CLSDF3116	TNF Receptor II Antibody	48 KD	Human, Mouse,Rat	WB IF/ICC	200ug	59670
CLSDF3117	EFNA1 Antibody	24 KD	Human, Mouse,Rat	WB IF/ICC	200ug	59670
CLSDF3118	CDC2L1 Antibody	92 KD	Human, Mouse	WB	200ug	59670
CLSDF3119	CRP1 Antibody	22 KD	Human, Mouse,Rat	WB IHC	200ug	59670
CLSDF3120	EPHA1 Antibody	108 KD	Human	WB IF/ICC	200ug	59670
CLSDF3121	KAPCG Antibody	40 KD	Human	WB	200ug	59670
CLSDF3122	hnRNP A2/B1 Antibody	36 KD	Human, Mouse	WB IF/ICC	200ug	59670
CLSDF3123	KAPCB Antibody	53 KD	Human, Mouse,Rat	WB	200ug	59670
CLSDF3124	S6K Antibody	70 KD	Human, Mouse,Rat	WB IHC	200ug	59670
CLSDF3125	NFYA Antibody	43 KD	Human, Mouse,Rat	WB	200ug	59670
CLSDF3126	IP3KA Antibody	52 KD	Human, Mouse,Rat	WB	200ug	59670
CLSDF3127	DGKA Antibody	80 KD	Human	WB	200ug	59670
CLSDF3128	DTYMK Antibody	22 KD	Human	WB IHC	200ug	59670
CLSDF3129	AKAP5 Antibody	47 KD	Human	WB IF/ICC	200ug	59670
CLSDF3130	CDK2 Antibody	33 KD	Human, Mouse,Rat	WB IF/ICC	200ug	59670
CLSDF3131	NFYB Antibody	29 KD	Human, Mouse,Rat	WB	200ug	59670
CLSDF3132	PTX3 Antibody	40 KD	Human, Mouse	WB IF/ICC	200ug	59670
CLSDF3133	HMGB2 Antibody	27 KD	Human, Mouse,Rat	WB	200ug	59670
CLSDF3134	p44 MAPK Antibody	45 KD	Human, Mouse,Rat	WB	200ug	59670
CLSDF3135	MARK3 Antibody	85 KD	Human, Mouse,Rat	WB IHC	200ug	59670
CLSDF3136	ARNT Antibody	87 KD	Human, Mouse,Rat	WB	200ug	59670
CLSDF3137	RL10 Antibody	25 KD	Human, Mouse,Rat	WB	200ug	59670
CLSDF3138	APEX1 Antibody	34 KD	Human, Mouse,Rat	WB	200ug	59670
CLSDF3139	CALR Antibody	48 KD	Human, Mouse,Rat	WB IHC IF/ICC	200ug	59670
CLSDF3140	IP3KB Antibody	0 KD	Human, Mouse,Rat	WB	200ug	59670
CLSDF3141	TEAD1 Antibody	0 KD	Human, Mouse,Rat	WB IHC	200ug	59670
CLSDF3142	MZF-1 Antibody	82 KD	Human	WB IHC	200ug	59670
CLSDF3143	ERCC5 Antibody	130 KD	Human	WB	200ug	59670
CLSDF3144	TF2E2 Antibody	33 KD	Human, Mouse	WB IHC	200ug	59670
CLSDF3145	EPHA3 Antibody	120 KD	Human, Mouse,Rat	WB	200ug	59670
CLSDF3146	LTK Antibody	92 KD	Human, Mouse	WB	200ug	59670
CLSDF3147	PPIF Antibody	22 KD	Human, Mouse,Rat	WB IHC	200ug	59670
CLSDF3148	CORO1A Antibody	0 KD	Human, Mouse,Rat	WB IHC	200ug	59670
CLSDF3149	HOXA7 Antibody	25 KD	Human, Mouse,Rat	WB	200ug	59670
CLSDF3150	KAP1 Antibody	43 KD	Human, Mouse,Rat	WB	200ug	59670
CLSDF3151	GK Antibody	57 KD	Human, Mouse,Rat	WB IF/ICC	200ug	59670
CLSDF3152	GRK4 Antibody	0 KD	Human	0	200ug	59670
CLSDF3153	FOXN2 Antibody	36 KD	Human	WB	200ug	59670
CLSDF3154	ELF1 Antibody	67 KD	Human	WB IF/ICC	200ug	59670
CLSDF3155	TF2H1 Antibody	57 KD	Human, Mouse	WB IHC	200ug	59670
CLSDF3156	CD153 Antibody	38 KD	Human, Mouse	WB	200ug	59670
CLSDF3157	CIITA Antibody	123 KD	Human, Mouse,Rat	WB	200ug	59670
CLSDF3158	CSTF2 Antibody	60 KD	Human, Mouse	WB IF/ICC	200ug	59670
CLSDF3159	GRK5 Antibody	68 KD	Human, Mouse,Rat	WB	200ug	59670
CLSDF3160	Recoverin Antibody	23 KD	Human, Mouse	WB	200ug	59670
CLSDF3161	RORA Antibody	60 KD	Human	WB IHC	200ug	59670



Antibodies

HSN : 38220090

Cat#	Product Description	MW	Reactivity	Application	Pack Size	Unit Price
CLSDF3162	HOXD12 Antibody	28 KD	Human, Mouse	WB	200ug	59670
CLSDF3163	Actinin α -2/3 Antibody	103 KD	Human, Mouse,Rat	WB IHC IF/ICC	200ug	59670
CLSDF3164	CD147 Antibody	48 36 KD	Human, Mouse,Rat	WB IHC	200ug	59670
CLSDF3165	GRK3 Antibody	80 KD	Human, Mouse,Rat	WB	200ug	59670
CLSDF3166	ATP7B Antibody	0 KD	Human, Mouse,Rat	IHC IF/ICC	200ug	59670
CLSDF3167	SOX6 Antibody	91 KD	Human, Mouse,Rat	WB	200ug	59670
CLSDF3168	TCF7 Antibody	42 KD	Human, Mouse	WB	200ug	59670
CLSDF3169	ACV1B Antibody	56 KD	Human, Mouse,Rat	WB IF/ICC	200ug	59670
CLSDF3170	ACVL1 Antibody	56 KD	Human, Mouse,Rat	WB IHC IF/ICC	200ug	59670
CLSDF3171	hnRNP G Antibody	40 KD	Human, Mouse,Rat	WB IF/ICC	200ug	59670
CLSDF3172	FEN1 Antibody	42 KD	Human, Mouse,Rat	WB IHC IF/ICC	200ug	59670
CLSDF3173	CUTL1 Antibody	164 KD	Human, Mouse	WB	200ug	59670
CLSDF3174	ETV6 Antibody	53 KD	Human, Mouse,Rat	WB IF/ICC	200ug	59670
CLSDF3175	BUD31 Antibody	17 KD	Human, Mouse,Rat	WB	200ug	59670
CLSDF3176	CSK Antibody	55 KD	Human, Mouse,Rat	WB IF/ICC	200ug	59670
CLSDF3177	NBL1 Antibody	19 KD	Human	WB IHC IF/ICC	200ug	59670
CLSDF3178	TNFSF9 Antibody	23 KD	Human	WB IF/ICC	200ug	59670
CLSDF3179	FRK Antibody	55 KD	Human, Mouse,Rat	WB IHC IF/ICC	200ug	59670
CLSDF3180	GRK6 Antibody	65 KD	Human, Mouse,Rat	WB IF/ICC	200ug	59670
CLSDF3181	KPB1/2 Antibody	0 KD	Human, Mouse,Rat	0	200ug	59670
CLSDF3182	YAP Antibody	67 KD	Human, Mouse,Rat	WB	200ug	59670
CLSDF3183	ID4 Antibody	24 KD	Human, Mouse,Rat	WB	200ug	59670
CLSDF3184	TISD Antibody	40 KD	Human, Mouse	WB	200ug	59670
CLSDF3185	CKI- α Antibody	35 KD	Human, Mouse,Rat	WB IHC IF/ICC	200ug	59670
CLSDF3186	CDK8 Antibody	53 KD	Human, Mouse	WB	200ug	59670
CLSDF3187	HOXA1 Antibody	37 KD	Human, Mouse,Rat	WB	200ug	59670
CLSDF3188	CKI- ϵ Antibody	47 KD	Human, Mouse	WB IHC IF/ICC	200ug	59670
CLSDF3189	CLK1 Antibody	57 KD	Human, Mouse	WB IF/ICC	200ug	59670
CLSDF3190	CLK2 Antibody	60 KD	Human, Mouse,Rat	WB	200ug	59670
CLSDF3191	HINT1 Antibody	28 KD	Human, Mouse,Rat	WB IF/ICC	200ug	59670
CLSDF3192	MEOX2 Antibody	33 KD	Human, Mouse,Rat	WB	200ug	59670
CLSDF3193	ER81 Antibody	60 KD	Human, Mouse	WB	200ug	59670
CLSDF3194	CD253 Antibody	30 KD	Human	WB IF/ICC	200ug	59670
CLSDF3195	FXR2 Antibody	74 KD	Human, Mouse	WB IHC IF/ICC	200ug	59670
CLSDF3196	RORG Antibody	58 KD	Human, Mouse	WB	200ug	59670
CLSDF3197	GALK1 Antibody	45 KD	Human, Mouse,Rat	WB	200ug	59670
CLSDF3198	BAP31 Antibody	28 KD	Human, Mouse,Rat	WB	200ug	59670
CLSDF3199	BMX Antibody	75 KD	Human, Mouse	WB IHC IF/ICC	200ug	59670
CLSDF3200	ZNF75 Antibody	40 KD	Human	WB	200ug	59670
CLSDF3201	hnRNP M Antibody	85 78 KD	Human, Mouse,Rat	WB IHC IF/ICC	200ug	59670
CLSDF3202	NCBP2 Antibody	18 KD	Human, Mouse	WB	200ug	59670
CLSDF3203	DGKE Antibody	60 KD	Human, Mouse,Rat	WB	200ug	59670
CLSDF3204	hnRNP F Antibody	48 KD	Human, Mouse,Rat	WB	200ug	59670
CLSDF3205	ZNF134 Antibody	36 KD	Human	WB	200ug	59670
CLSDF3206	RBM5 Antibody	92 KD	Human, Mouse	WB IHC	200ug	59670
CLSDF3207	EFNA3 Antibody	38 KD	Human, Mouse,Rat	WB	200ug	59670
CLSDF3208	EFNA5 Antibody	25 KD	Human, Mouse,Rat	WB IHC IF/ICC	200ug	59670
CLSDF3209	DGKQ Antibody	101 KD	Human	WB	200ug	59670
CLSDF3210	CEBPG Antibody	22 KD	Human, Mouse,Rat	WB IHC	200ug	59670
CLSDF3211	LIMK2 Antibody	70 KD	Human, Mouse,Rat	WB IHC IF/ICC	200ug	59670
CLSDF3212	MAPK10 Antibody	48 KD	Human, Mouse,Rat	WB	200ug	59670
CLSDF3213	PTTG Antibody	20 KD	Human, Mouse,Rat	WB IHC	200ug	59670
CLSDF3214	PRKAG1/2/3 Antibody	38 KD	Human, Mouse,Rat	WB	200ug	59670
CLSDF3215	EPHB4 Antibody	108 KD	Human, Mouse	WB	200ug	59670
CLSDF3216	AF10 Antibody	109 KD	Human, Mouse	WB	200ug	59670
CLSDF3217	ELL Antibody	65 KD	Human, Mouse	WB	200ug	59670
CLSDF3218	ADK Antibody	40 KD	Human, Mouse,Rat	WB	200ug	59670
CLSDF3219	hnRNP H Antibody	49 KD	Human, Mouse,Rat	WB	200ug	59670
CLSDF3220	DLX5 Antibody	32 KD	Human, Mouse,Rat	WB IHC	200ug	59670
CLSDF3221	CKS1 Antibody	9 KD	Human, Mouse	WB IF/ICC	200ug	59670
CLSDF3222	COPS2 Antibody	55 KD	Human, Mouse,Rat	WB IF/ICC	200ug	59670
CLSDF3223	LMO4 Antibody	44 KD	Human, Mouse,Rat	WB	200ug	59670
CLSDF3224	PITX1 Antibody	34 KD	Human, Mouse,Rat	WB	200ug	59670
CLSDF3225	IRX1 Antibody	47 KD	Human, Mouse	WB	200ug	59670
CLSDF3226	ST5 Antibody	126 KD	Human, Mouse	WB	200ug	59670
CLSDF3227	ADARB1 Antibody	80 KD	Human, Mouse,Rat	WB	200ug	59670
CLSDF3228	SSBP2 Antibody	38 KD	Human, Mouse	WB IHC	200ug	59670
CLSDF3229	CRBP III Antibody	0 KD	Human	IHC IF/ICC	200ug	59670



Antibodies

HSN : 38220090

Cat#	Product Description	MW	Reactivity	Application	Pack Size	Unit Price
CLSDF3230	SFRS3 Antibody	25 KD	Human, Mouse	WB IF/ICC	200ug	59670
CLSDF3231	FOXK1 Antibody	78 KD	Human, Mouse	WB	200ug	59670
CLSDF3232	TFAM Antibody	0 KD	Human	IHC IF/ICC	200ug	59670
CLSDF3233	CDK1 Antibody	42 KD	Human,Rat	WB	200ug	59670
CLSDF3234	K6PP Antibody	84 KD	Human, Mouse,Rat	WB	200ug	59670
CLSDF3235	SFRS17A Antibody	0 KD	Human	WB	200ug	59670
CLSDF3236	MEF2B Antibody	38 KD	Human, Mouse	WB	200ug	59670
CLSDF3237	CREM Antibody	34 KD	Human, Mouse,Rat	WB	200ug	59670
CLSDF3238	Mevalonate Kinase Antibody	42 KD	Human	WB IHC	200ug	59670
CLSDF3239	TLE2 Antibody	110 KD	Human	WB	200ug	59670
CLSDF3240	MSSB Antibody	17 KD	Human, Mouse,Rat	WB IHC IF/ICC	200ug	59670
CLSDF3241	CSTF1 Antibody	48 KD	Human, Mouse,Rat	WB	200ug	59670
CLSDF3242	SRY Antibody	37 KD	Human	WB	200ug	59670
CLSDF3243	TNFC Antibody	22 KD	Human, Mouse	WB IF/ICC	200ug	59670
CLSDF3244	TNFRSF9 Antibody	27 KD	Human	WB	200ug	59670
CLSDF3245	SFRS4 Antibody	57 KD	Human, Mouse	WB	200ug	59670
CLSDF3246	NCBP1 Antibody	80 KD	Human, Mouse,Rat	WB	200ug	59670
CLSDF3247	MN1 Antibody	135 KD	Human	WB	200ug	59670
CLSDF3248	TEF Antibody	37 KD	Human, Mouse,Rat	WB	200ug	59670
CLSDF3249	AKAP13 Antibody	307 KD	Human	WB IHC	200ug	59670
CLSDF3250	Nuclear Factor 1 Antibody	55 KD	Human, Mouse,Rat	WB	200ug	59670
CLSDF3251	ELAVL2 Antibody	38 KD	Human, Mouse,Rat	WB	200ug	59670
CLSDF3252	FOXC1/2 Antibody	57 KD	Human, Mouse,Rat	WB	200ug	59670
CLSDF3253	FOXL1 Antibody	36 KD	Human	WB	200ug	59670
CLSDF3254	CAF1A Antibody	150 KD	Human, Mouse	WB	200ug	59670
CLSDF3255	CAF1B Antibody	61 KD	Human, Mouse,Rat	WB	200ug	59670
CLSDF3256	PSMD2 Antibody	100 KD	Human, Mouse,Rat	WB	200ug	59670
CLSDF3257	CGK 2 Antibody	87 KD	Human, Mouse,Rat	WB	200ug	59670
CLSDF3258	MTA1 Antibody	80 KD	Human, Mouse,Rat	WB	200ug	59670
CLSDF3259	KLF Antibody	38 KD	Human, Mouse,Rat	WB	200ug	59670
CLSDF3260	JIP2 Antibody	87 KD	Human, Mouse,Rat	WB IHC IF/ICC	200ug	59670
CLSDF3261	TCOF1 Antibody	152 KD	Human, Mouse	WB IHC	200ug	59670
CLSDF3262	TUSC3 Antibody	39 KD	Human, Mouse,Rat	WB IF/ICC	200ug	59670
CLSDF3263	FOXE3 Antibody	33 KD	Human, Mouse,Rat	WB	200ug	59670
CLSDF3264	Myelodysplasia Syndrome 1 Antibody	18 KD	Human	WB	200ug	59670
CLSDF3265	TOP3A Antibody	115 KD	Human, Mouse	WB	200ug	59670
CLSDF3266	Smad4 Antibody	60 KD	Human, Mouse,Rat	WB	200ug	59670
CLSDF3267	TDG Antibody	46 KD	Human, Mouse,Rat	WB	200ug	59670
CLSDF3268	ITPK1 Antibody	50 KD	Human, Mouse	WB	200ug	59670
CLSDF3269	TRA-2 α Antibody	33 KD	Human, Mouse	WB IHC IF/ICC	200ug	59670
CLSDF3270	DYR1A Antibody	90 KD	Human, Mouse,Rat	WB IF/ICC	200ug	59670
CLSDF3271	TNAP1 Antibody	34 KD	Human, Mouse,Rat	WB	200ug	59670
CLSDF3272	TF2H2 Antibody	62 KD	Human, Mouse,Rat	WB	200ug	59670
CLSDF3273	CBF β Antibody	22 KD	Human, Mouse,Rat	WB IHC	200ug	59670
CLSDF3274	GIT2 Antibody	84 KD	Human, Mouse,Rat	WB	200ug	59670
CLSDF3275	E2F2 Antibody	48 KD	Human, Mouse	WB	200ug	59670
CLSDF3276	ZNF147 Antibody	71 KD	Human	WB	200ug	59670
CLSDF3277	Glucokinase Regulator Antibody	68 KD	Human, Mouse,Rat	WB	200ug	59670
CLSDF3278	MELK Antibody	75 KD	Human	WB	200ug	59670
CLSDF3279	HLX1 Antibody	75 KD	Human, Mouse,Rat	WB IF/ICC	200ug	59670
CLSDF3280	ZNF638 Antibody	220 KD	Human	WB IHC	200ug	59670
CLSDF3281	FAKD3 Antibody	75 KD	Human	WB	200ug	59670
CLSDF3282	WTAP Antibody	44 KD	Human, Mouse	WB	200ug	59670
CLSDF3283	PSMD2 Antibody	100 KD	Human, Mouse,Rat	WB	200ug	59670
CLSDF3284	CDK5R1 Antibody	38 KD	Human, Mouse,Rat	WB IF/ICC	200ug	59670
CLSDF3285	CDK10 Antibody	43 KD	Human, Mouse,Rat	WB	200ug	59670
CLSDF3286	PDGFRL Antibody	0 KD	Human, Mouse,Rat	0	200ug	59670
CLSDF3287	ANKRD1 Antibody	36 KD	Human, Mouse,Rat	WB	200ug	59670
CLSDF3288	EPHA7 Antibody	112 KD	Human, Mouse,Rat	WB	200ug	59670
CLSDF3289	SURF1 Antibody	30 KD	Human, Mouse,Rat	WB	200ug	59670
CLSDF3290	TAF5 Antibody	87 KD	Human, Mouse	WB IHC	200ug	59670
CLSDF3291	TAF1A Antibody	53 KD	Human,Rat	WB	200ug	59670
CLSDF3292	TSN Antibody	26 KD	Human, Mouse,Rat	WB IHC	200ug	59670
CLSDF3293	TRIP13 Antibody	48 KD	Human, Mouse,Rat	WB	200ug	59670
CLSDF3294	MED1 Antibody	170 KD	Human, Mouse	WB IHC	200ug	59670
CLSDF3295	TRIP4 Antibody	66 KD	Human, Mouse	WB	200ug	59670
CLSDF3296	RhoH Antibody	21 KD	Human, Mouse,Rat	WB IF/ICC	200ug	59670
CLSDF3297	TSC22D1 Antibody	16 KD	Human, Mouse,Rat	WB IHC IF/ICC	200ug	59670
CLSDF3298	NAB2 Antibody	56 KD	Human, Mouse	WB IHC	200ug	59670
CLSDF3299	CEBPE Antibody	26 KD	Human, Mouse,Rat	WB	200ug	59670

Antibodies
HSN : 38220090

Cat#	Product Description	MW	Reactivity	Application	Pack Size	Unit Price
CLSDF3300	Smad1/5/9 Antibody	56 KD	Human, Mouse,Rat	WB	200ug	59670
CLSDF3301	VPS72 Antibody	41 KD	Human, Mouse	WB IHC	200ug	59670
CLSDF3302	MAPK3 Antibody	42 KD	Human, Mouse,Rat	WB IHC	200ug	59670
CLSDF3303	NFIL3 Antibody	51 KD	Human, Mouse,Rat	WB	200ug	59670
CLSDF3304	p97 MAPK Antibody	85 KD	Human, Mouse,Rat	WB IF/ICC	200ug	59670
CLSDF3305	ZNF187 Antibody	55 KD	Human	WB IF/ICC	200ug	59670
CLSDF3306	DGKD Antibody	135 KD	Human	WB	200ug	59670
CLSDF3307	PFKFB1/4 Antibody	54 KD	Human, Mouse,Rat	WB	200ug	59670
CLSDF3308	DOK7 Antibody	60 KD	Human, Mouse	WB IHC IF/ICC	200ug	59670
CLSDF3309	AAK1 Antibody	94 KD	Human, Mouse,Rat	WB	200ug	59670
CLSDF3310	DAK Antibody	59 KD	Human, Mouse,Rat	WB	200ug	59670
CLSDF3311	ADCK5 Antibody	66 KD	Human	WB	200ug	59670
CLSDF3312	CERKL Antibody	63 KD	Human	WB	200ug	59670
CLSDF3313	PLCH Antibody	48 KD	Human, Mouse,Rat	WB IF/ICC	200ug	59670
CLSDF3314	TSSC1 Antibody	48 KD	Human, Mouse,Rat	WB	200ug	59670
CLSDF3315	FAKD1 Antibody	97 KD	Human, Mouse	WB	200ug	59670
CLSDF3316	SGOL1 Antibody	64 KD	Human	WB	200ug	59670
CLSDF3317	CDKL4 Antibody	36 KD	Human	WB IHC IF/ICC	200ug	59670
CLSDF3318	UBXD5 Antibody	57 KD	Human	WB IHC	200ug	59670
CLSDF3319	RBM26 Antibody	113 KD	Human, Mouse	WB	200ug	59670
CLSDF3320	TTC23 Antibody	50 KD	Human	WB	200ug	59670
CLSDF3321	STEA3 Antibody	54 KD	Human, Mouse,Rat	WB IF/ICC	200ug	59670
CLSDF3322	STEA4 Antibody	0 KD	Human	IHC IF/ICC	200ug	59670
CLSDF3323	LD0C1L Antibody	24 KD	Human, Mouse	WB	200ug	59670
CLSDF3324	MAST2 Antibody	196 KD	Human, Mouse	WB	200ug	59670
CLSDF3325	SFXN4 Antibody	37 KD	Human	WB	200ug	59670
CLSDF3326	TNFAIP8L2 Antibody	20 KD	Human, Mouse,Rat	WB	200ug	59670
CLSDF3327	DOK6 Antibody	43 KD	Human, Mouse	WB IF/ICC	200ug	59670
CLSDF3328	KSR2 Antibody	108 KD	Human, Mouse	WB IF/ICC	200ug	59670
CLSDF3329	MARK2 Antibody	85 KD	Human, Mouse,Rat	WB IF/ICC	200ug	59670
CLSDF3330	ARMCX2 Antibody	65 KD	Human, Mouse,Rat	WB IF/ICC	200ug	59670
CLSDF3331	DOK3 Antibody	58 KD	Human, Mouse	WB	200ug	59670
CLSDF3332	MAEA Antibody	45 KD	Human, Mouse,Rat	WB	200ug	59670
CLSDF3333	MOL1A Antibody	25 KD	Human, Mouse	WB	200ug	59670
CLSDF3334	STRAD Antibody	46 KD	Human, Mouse	WB	200ug	59670
CLSDF3335	ADCK2 Antibody	69 KD	Human	WB	200ug	59670
CLSDF3336	ATPBD3 Antibody	36 KD	Human	WB	200ug	59670
CLSDF3337	MOBKL2B Antibody	23 KD	Human, Mouse	WB	200ug	59670
CLSDF3338	ADCK1 Antibody	61 KD	Human, Mouse	WB	200ug	59670
CLSDF3339	MAGI2 Antibody	159 KD	Human, Mouse,Rat	WB	200ug	59670
CLSDF3340	AKAP14 Antibody	23 KD	Human	WB IF/ICC	200ug	59670
CLSDF3341	SIAH1 Antibody	34 KD	Human, Mouse,Rat	WB	200ug	59670
CLSDF3342	MAP4K3 Antibody	101 KD	Human, Mouse,Rat	WB	200ug	59670
CLSDF3343	TRIM59 Antibody	47 KD	Human, Mouse	WB IHC IF/ICC	200ug	59670
CLSDF3344	LMTK2 Antibody	164 KD	Human	WB IHC IF/ICC	200ug	59670
CLSDF3345	TUSC5 Antibody	22 KD	Human	WB IF/ICC	200ug	59670
CLSDF3346	TBC1D3 Antibody	62 KD	Human	WB	200ug	59670
CLSDF3347	FUK Antibody	110 KD	Human, Mouse	WB IF/ICC	200ug	59670
CLSDF3348	KIAA1967 Antibody	102 KD	Human	WB	200ug	59670
CLSDF3349	DCLK2 Antibody	83 KD	Human, Mouse	WB	200ug	59670
CLSDF3350	SPIC Antibody	29 KD	Human	WB	200ug	59670
CLSDF3351	CAMK5 Antibody	54 KD	Human, Mouse,Rat	WB IHC IF/ICC	200ug	59670
CLSDF3352	HIPK4 Antibody	70 KD	Human, Mouse,Rat	WB IHC IF/ICC	200ug	59670
CLSDF3353	ACRBP Antibody	61 KD	Human	WB	200ug	59670
CLSDF3354	RGAG1 Antibody	144 KD	Human, Mouse	WB	200ug	59670
CLSDF3355	PPHLN Antibody	53 KD	Human, Mouse	WB IHC	200ug	59670
CLSDF3356	ZNF397 Antibody	61 KD	Human	WB	200ug	59670
CLSDF3357	ANKK1 Antibody	84 KD	Human	WB	200ug	59670
CLSDF3358	BAF250B Antibody	170 KD	Human,Rat	WB IF/ICC	200ug	59670
CLSDF3359	IPMK Antibody	47 KD	Human, Mouse,Rat	WB	200ug	59670
CLSDF3360	ADCK3 Antibody	50 KD	Human, Mouse,Rat	WB	200ug	59670
CLSDF3361	PPP1R14C Antibody	20 KD	Human, Mouse,Rat	WB	200ug	59670
CLSDF3362	LMO3 Antibody	17 KD	Human, Mouse,Rat	WB	200ug	59670
CLSDF3363	SMRC2 Antibody	160 KD	Human, Mouse	WB	200ug	59670
CLSDF3364	RIN3 Antibody	107 KD	Human	WB	200ug	59670
CLSDF3365	ZNF596 Antibody	58 KD	Human	WB IHC	200ug	59670
CLSDF3366	BRSK1 Antibody	87 KD	Human, Mouse	WB	200ug	59670
CLSDF3367	ES8L1 Antibody	80 KD	Human, Mouse	WB IHC	200ug	59670
CLSDF3368	PARD3 Antibody	151 KD	Human, Mouse,Rat	WB IF/ICC	200ug	59670
CLSDF3369	DOK4 Antibody	37 KD	Human, Mouse	WB	200ug	59670

Antibodies
HSN : 38220090

Cat#	Product Description	MW	Reactivity	Application	Pack Size	Unit Price
CLSDF3370	GRK7 Antibody	62 KD	Human	WB	200ug	59670
CLSDF3371	DUSP19 Antibody	28 KD	Human	WB IF/ICC	200ug	59670
CLSDF3372	GTF3C2 Antibody	100 KD	Human	WB	200ug	59670
CLSDF3373	ORAOV1 Antibody	15 KD	Human	WB	200ug	59670
CLSDF3374	MADD Antibody	183 KD	Human, Mouse,Rat	WB IHC IF/ICC	200ug	59670
CLSDF3375	CNKR2 Antibody	117 KD	Human, Mouse,Rat	WB	200ug	59670
CLSDF3376	BRI3B Antibody	27 KD	Human, Mouse	WB IHC	200ug	59670
CLSDF3377	SMG7 Antibody	127 KD	Human	WB IF/ICC	200ug	59670
CLSDF3378	AKAP1 Antibody	90 KD	Human	WB IHC IF/ICC	200ug	59670
CLSDF3379	CDKL2 Antibody	56 KD	Human	WB	200ug	59670
CLSDF3380	REQU Antibody	44 KD	Human, Mouse	WB IF/ICC	200ug	59670
CLSDF3381	EZH1 Antibody	85 KD	Human, Mouse	WB IHC	200ug	59670
CLSDF3382	TAF15 Antibody	62 KD	Human, Mouse	WB IHC	200ug	59670
CLSDF3383	GCN5L2 Antibody	100 KD	Human, Mouse	WB	200ug	59670
CLSDF3384	CELF-1 Antibody	52 KD	Human, Mouse,Rat	WB	200ug	59670
CLSDF3385	MEKKK 1 Antibody	91 KD	Human, Mouse	WB	200ug	59670
CLSDF3386	FOXJ1 Antibody	60 KD	Human, Mouse,Rat	WB	200ug	59670
CLSDF3387	DLX4 Antibody	34 KD	Human	WB	200ug	59670
CLSDF3388	BRF1 Antibody	74 KD	Human, Mouse	WB IHC IF/ICC	200ug	59670
CLSDF3389	CNKSRI1 Antibody	80 KD	Human, Mouse,Rat	WB	200ug	59670
CLSDF3390	MKL1 Antibody	99 KD	Human, Mouse	WB	200ug	59670
CLSDF3391	PMEPA1 Antibody	37 KD	Human	WB IHC IF/ICC	200ug	59670
CLSDF3392	ISL2 Antibody	40 KD	Human, Mouse,Rat	WB	200ug	59670
CLSDF3393	JAKMIP2 Antibody	95 KD	Human	WB IHC	200ug	59670
CLSDF3394	ORCTL-2 Antibody	43 KD	Human	WB	200ug	59670
CLSDF3395	MOBK12A/B Antibody	25 KD	Human, Mouse	WB	200ug	59670
CLSDF3396	RASD2 Antibody	35 KD	Human, Mouse,Rat	WB	200ug	59670
CLSDF3397	IP3KC Antibody	102 KD	Human	WB	200ug	59670
CLSDF3398	MASTL Antibody	97 KD	Human, Mouse	WB	200ug	59670
CLSDF3399	PGBD1 Antibody	92 KD	Human	WB	200ug	59670
CLSDF3400	ZNF668 Antibody	68 KD	Human, Mouse	WB	200ug	59670
CLSDF3401	FAM84B Antibody	36 KD	Human	WB	200ug	59670
CLSDF3402	PKNOX2 Antibody	55 KD	Human, Mouse	WB	200ug	59670
CLSDF3403	IP6K3 Antibody	51 KD	Human, Mouse	WB IHC	200ug	59670
CLSDF3404	LMTK3 Antibody	40 KD	Human, Mouse	WB	200ug	59670
CLSDF3405	AL2S7 Antibody	46 KD	Human, Mouse	WB	200ug	59670
CLSDF3406	CIB3 Antibody	32 KD	Human, Mouse	WB	200ug	59670
CLSDF3407	ALPK1 Antibody	139 KD	Human, Mouse	WB	200ug	59670
CLSDF3408	RPS6KC1 Antibody	117 KD	Human, Mouse	WB IF/ICC	200ug	59670
CLSDF3409	SERINC2 Antibody	55 KD	Human, Mouse,Rat	WB IF/ICC	200ug	59670
CLSDF3410	MAP3K3 Antibody	71 KD	Human, Mouse	WB	200ug	59670
CLSDF3411	FOXB1/2 Antibody	45 KD	Human, Mouse	WB	200ug	59670
CLSDF3412	ATF6B Antibody	76 KD	Human	WB	200ug	59670
CLSDF3413	DUSP9 Antibody	42 KD	Human, Mouse,Rat	WB IHC IF/ICC	200ug	59670
CLSDF3414	ADPGK Antibody	47 KD	Human, Mouse,Rat	WB	200ug	59670
CLSDF3415	TINF2 Antibody	53 KD	Human	WB	200ug	59670
CLSDF3416	MMTAG2 Antibody	34 KD	Human, Mouse,Rat	WB	200ug	59670
CLSDF3417	MKNK1 Antibody	51 KD	Human, Mouse	WB	200ug	59670
CLSDF3418	UTP14A Antibody	85 KD	Human, Mouse	WB	200ug	59670
CLSDF3419	NADAP Antibody	85 KD	Human, Mouse	WB	200ug	59670
CLSDF3420	NARG1 Antibody	100 KD	Human, Mouse	WB	200ug	59670
CLSDF3421	AN30A Antibody	153 KD	Human	WB	200ug	59670
CLSDF3422	YTHDF1 Antibody	61 KD	Human, Mouse,Rat	WB	200ug	59670
CLSDF3423	IFIH1 Antibody	120 KD	Human, Mouse	WB	200ug	59670
CLSDF3424	ZNF436 Antibody	50 KD	Human	WB	200ug	59670
CLSDF3425	BHLHB3 Antibody	50 KD	Human, Mouse,Rat	WB	200ug	59670
CLSDF3426	PBOV1 Antibody	19 KD	Human	WB	200ug	59670
CLSDF3427	ILKAP Antibody	45 KD	Human, Mouse,Rat	WB IHC	200ug	59670
CLSDF3428	ZNF541 Antibody	83 KD	Human	WB	200ug	59670
CLSDF3429	XRN2 Antibody	108 KD	Human, Mouse	WB IHC	200ug	59670
CLSDF3430	NT5C3 Antibody	38 KD	Human, Mouse	WB IHC	200ug	59670
CLSDF3431	SLK Antibody	150 KD	Human, Mouse,Rat	WB IHC IF/ICC	200ug	59670
CLSDF3432	BLZF1 Antibody	47 KD	Human, Mouse	WB	200ug	59670
CLSDF3433	MUC13 Antibody	50 KD	Human	WB IHC IF/ICC	200ug	59670
CLSDF3434	SEMA4A Antibody	84 KD	Human, Mouse,Rat	WB IHC	200ug	59670
CLSDF3435	PRDM12 Antibody	40 KD	Human, Mouse	WB	200ug	59670
CLSDF3436	ZNF435 Antibody	41 KD	Human, Mouse	WB	200ug	59670
CLSDF3437	AZ12 Antibody	48 KD	Human, Mouse,Rat	WB	200ug	59670
CLSDF3438	FKRP Antibody	50 KD	Human, Mouse,Rat	WB	200ug	59670
CLSDF3439	LASS4 Antibody	46 KD	Human	WB IHC	200ug	59670

Antibodies

HSN : 38220090

Cat#	Product Description	MW	Reactivity	Application	Pack Size	Unit Price
CLSDF3440	ZNF287 Antibody	90 KD	Human	WB IHC	200ug	59670
CLSDF3441	ARNT2 Antibody	79 KD	Human, Mouse,Rat	WB	200ug	59670
CLSDF3442	BRMS1 Antibody	28 KD	Human, Mouse,Rat	WB	200ug	59670
CLSDF3443	DCP1A Antibody	75 KD	Human, Mouse	WB	200ug	59670
CLSDF3444	BCA3 Antibody	26 KD	Human	WB IHC	200ug	59670
CLSDF3445	DUSP22 Antibody	21 KD	Human, Mouse	WB	200ug	59670
CLSDF3446	SERC1 Antibody	48 KD	Human, Mouse,Rat	WB	200ug	59670
CLSDF3447	CREBZF Antibody	26 KD	Human, Mouse	WB IF/ICC	200ug	59670
CLSDF3448	IARS2 Antibody	114 KD	Human, Mouse	WB IHC IF/ICC	200ug	59670
CLSDF3449	MED17 Antibody	73 KD	Human, Mouse	WB	200ug	59670
CLSDF3450	EK12 Antibody	45 KD	Human, Mouse	WB	200ug	59670
CLSDF3451	DNAJC17 Antibody	35 KD	Human, Mouse	WB	200ug	59670
CLSDF3452	DUS2L Antibody	55 KD	Human, Mouse	WB IHC	200ug	59670
CLSDF3453	AATF Antibody	63 KD	Human, Mouse,Rat	WB	200ug	59670
CLSDF3454	MLTK Antibody	91 KD	Human, Mouse	WB IF/ICC	200ug	59670
CLSDF3455	RBAK Antibody	85 KD	Human, Mouse	WB	200ug	59670
CLSDF3456	EZAK3 Antibody	125 KD	Human	WB IF/ICC	200ug	59670
CLSDF3457	MARK Antibody	89 KD	Human, Mouse,Rat	WB	200ug	59670
CLSDF3458	HMG20B Antibody	36 KD	Human	WB	200ug	59670
CLSDF3459	DNMT3B Antibody	96 KD	Human	WB IHC IF/ICC	200ug	59670
CLSDF3460	LW-1 Antibody	47 KD	Human	WB	200ug	59670
CLSDF3461	MRC2 Antibody	167 KD	Human, Mouse,Rat	WB IHC IF/ICC	200ug	59670
CLSDF3462	DBF4 Antibody	77 KD	Human, Mouse	WB	200ug	59670
CLSDF3463	MORF4L1 Antibody	41 KD	Human, Mouse	WB IF/ICC	200ug	59670
CLSDF3464	EPHA6 Antibody	0 KD	Human, Mouse,Rat	IHC IF/ICC	200ug	59670
CLSDF3465	ZC3H7B Antibody	111 KD	Human	WB	200ug	59670
CLSDF3466	Mlx Antibody	33 KD	Human, Mouse,Rat	WB	200ug	59670
CLSDF3467	TRPS1 Antibody	0 KD	Human, Mouse	IHC	200ug	59670
CLSDF3468	CARKL Antibody	55 KD	Human, Mouse,Rat	WB IHC	200ug	59670
CLSDF3469	CNOT7 Antibody	36 KD	Human, Mouse	WB	200ug	59670
CLSDF3470	STAG3 Antibody	139 KD	Human	WB	200ug	59670
CLSDF3471	FOXD3 Antibody	48 KD	Human, Mouse	WB IHC	200ug	59670
CLSDF3472	IKZF3 Antibody	62 KD	Human, Mouse	WB	200ug	59670
CLSDF3473	JIP3 Antibody	147 KD	Human, Mouse	WB IF/ICC	200ug	59670
CLSDF3474	MOK Antibody	48 KD	Human	WB IHC	200ug	59670
CLSDF3475	CDK11 Antibody	90 KD	Human	WB	200ug	59670
CLSDF3476	ZNF148 Antibody	89 KD	Human, Mouse,Rat	WB IHC	200ug	59670
CLSDF3477	CHKB Antibody	45 KD	Human	WB	200ug	59670
CLSDF3478	ERGI3 Antibody	43 KD	Human, Mouse	WB IF/ICC	200ug	59670
CLSDF3479	ASF1A Antibody	23 KD	Human, Mouse	WB	200ug	59670
CLSDF3480	ATF5 Antibody	31 KD	Human, Mouse,Rat	WB	200ug	59670
CLSDF3481	AKAP2 Antibody	96 KD	Human	WB	200ug	59670
CLSDF3482	YBOX2 Antibody	38 KD	Human, Mouse	WB	200ug	59670
CLSDF3483	TBX22 Antibody	58 KD	Human	WB	200ug	59670
CLSDF3484	DYR1B Antibody	70 KD	Human, Mouse	WB	200ug	59670
CLSDF3485	ATG4B Antibody	44 KD	Human, Mouse	WB IHC	200ug	59670
CLSDF3486	SUPT16H Antibody	119 KD	Human, Mouse	WB	200ug	59670
CLSDF3487	IRAK3 Antibody	68 KD	Human	WB IHC IF/ICC	200ug	59670
CLSDF3488	SPIN1 Antibody	30 KD	Human, Mouse,Rat	WB	200ug	59670
CLSDF3489	EID1 Antibody	21 KD	Human	WB IF/ICC	200ug	59670
CLSDF3490	14-3-3 β Antibody	28 KD	Human, Mouse,Rat	WB	200ug	59670
CLSDF3491	14-3-3 ε Antibody	29 KD	Human, Mouse,Rat	WB	200ug	59670
CLSDF3492	14-3-3 ε Antibody	42 KD	Human, Mouse,Rat	WB IF/ICC	200ug	59670
CLSDF3493	14-3-3 γ Antibody	28 KD	Human, Mouse,Rat	WB IHC IF/ICC	200ug	59670
CLSDF3494	14-3-3 ζ Antibody	28 KD	Human, Mouse,Rat	WB	200ug	59670
CLSDF3495	14-3-3 δ Antibody	28 KD	Human, Mouse,Rat	WB	200ug	59670
CLSDF3496	5-HT-1A Antibody	46 KD	Human, Mouse,Rat	WB	200ug	59670
CLSDF3497	5-HT-1B Antibody	0 KD	Human, Mouse,Rat	WB IHC IF/ICC	200ug	59670
CLSDF3498	5-HT-1E Antibody	42 KD	Human	WB	200ug	59670
CLSDF3499	5-HT-1F Antibody	38 KD	Human, Mouse,Rat	WB	200ug	59670
CLSDF3500	5-HT-2B Antibody	54 KD	Human	WB IHC IF/ICC	200ug	59670
CLSDF3501	5-HT-2C Antibody	55 KD	Human, Mouse,Rat	IHC IF/ICC	200ug	59670
CLSDF3502	5-HT-3A Antibody	55 KD	Human	WB	200ug	59670
CLSDF3503	5-HT-4 Antibody	43 KD	Human, Mouse,Rat	WB IF/ICC	200ug	59670
CLSDF3504	5-HT-5A Antibody	40 KD	Human	WB	200ug	59670
CLSDF3505	5-HT-6 Antibody	47 KD	Human, Mouse,Rat	WB	200ug	59670
CLSDF3506	ADRA1A Antibody	51 KD	Human	WB	200ug	59670
CLSDF3507	ADCY4 Antibody	120 KD	Human, Mouse,Rat	WB	200ug	59670
CLSDF3508	ADCY5/6 Antibody	138 KD	Human, Mouse,Rat	WB	200ug	59670
CLSDF3509	ADD2 Antibody	81 KD	Human, Mouse,Rat	WB IF/ICC	200ug	59670



Antibodies

HSN : 38220090

Cat#	Product Description	MW	Reactivity	Application	Pack Size	Unit Price
CLSDF3510	ADD3 Antibody	75 KD	Human, Mouse,Rat	WB	200ug	59670
CLSDF3511	ADRB1 Antibody	51 KD	Human, Mouse,Rat	WB	200ug	59670
CLSDF3512	ADRB2 Antibody	62 KD	Human, Mouse,Rat	WB IF/ICC	200ug	59670
CLSDF3513	AHSA1 Antibody	38 KD	Human	WB	200ug	59670
CLSDF3514	AIM2 Antibody	39 KD	Human	WB	200ug	59670
CLSDF3515	API-5 Antibody	58 KD	Human, Mouse	WB IHC	200ug	59670
CLSDF3516	ARRB1 Antibody	50 KD	Human, Mouse,Rat	WB	200ug	59670
CLSDF3517	ARRDC3 Antibody	46 KD	Human, Mouse,Rat	WB	200ug	59670
CLSDF3518	AS250 Antibody	210 KD	Human, Mouse	WB IHC IF/ICC	200ug	59670
CLSDF3519	AVEN Antibody	55 KD	Human	WB	200ug	59670
CLSDF3520	BCOR Antibody	192 KD	Human, Mouse	WB IHC	200ug	59670
CLSDF3521	BUB3 Antibody	40 KD	Human, Mouse,Rat	WB	200ug	59670
CLSDF3522	CD160 Antibody	17 KD	Human	WB	200ug	59670
CLSDF3523	CDH11 Antibody	85 KD	Human, Mouse	WB	200ug	59670
CLSDF3524	CDH15 Antibody	89 KD	Human, Mouse,Rat	WB	200ug	59670
CLSDF3525	CDH16 Antibody	90 KD	Human	WB	200ug	59670
CLSDF3526	CDH17 Antibody	99 KD	Human	WB IF/ICC	200ug	59670
CLSDF3527	CDH18 Antibody	88 KD	Human, Mouse	WB	200ug	59670
CLSDF3528	CDH19 Antibody	87 KD	Human	WB	200ug	59670
CLSDF3529	CDH22 Antibody	84 KD	Human, Mouse,Rat	WB IHC IF/ICC	200ug	59670
CLSDF3530	CDH2 Antibody	140 KD	Human, Mouse,Rat	WB	200ug	59670
CLSDF3531	CDH3 Antibody	86 KD	Human	WB IHC	200ug	59670
CLSDF3532	CDH7 Antibody	87 KD	Human, Mouse,Rat	WB	200ug	59670
CLSDF3533	CDH8 Antibody	90 KD	Human, Mouse,Rat	WB IHC IF/ICC	200ug	59670
CLSDF3534	CDH9 Antibody	89 KD	Human, Mouse	WB IHC IF/ICC	200ug	59670
CLSDF3535	CADM1 Antibody	49 KD	Human, Mouse	WB	200ug	59670
CLSDF3536	CADM2 Antibody	47 KD	Human, Mouse,Rat	WB	200ug	59670
CLSDF3537	CADM3 Antibody	43 KD	Human, Mouse,Rat	WB	200ug	59670
CLSDF3538	CADM4 Antibody	48 KD	Human, Mouse,Rat	WB IHC IF/ICC	200ug	59670
CLSDF3539	TMEM30B Antibody	38 KD	Human, Mouse	WB	200ug	59670
CLSDF3540	Cytochrome c-type Heme Lyase Antibody	31 KD	Human, Mouse	WB IHC IF/ICC	200ug	59670
CLSDF3541	CCRL1 Antibody	40 KD	Human, Mouse	WB IF/ICC	200ug	59670
CLSDF3542	p55CDC Antibody	50 KD	Human, Mouse,Rat	WB	200ug	59670
CLSDF3543	CDCA2 Antibody	113 KD	Human	WB	200ug	59670
CLSDF3544	CDCA3 Antibody	28 KD	Human, Mouse,Rat	WB IHC	200ug	59670
CLSDF3545	CDCA7 Antibody	43 KD	Human, Mouse,Rat	WB	200ug	59670
CLSDF3546	CDKAL Antibody	65 KD	Human,Rat	WB	200ug	59670
CLSDF3547	CDK5RAP3 Antibody	60 KD	Human, Mouse,Rat	WB	200ug	59670
CLSDF3548	CMKLR1 Antibody	42 KD	Human, Mouse,Rat	WB	200ug	59670
CLSDF3549	Collagen I α 2 Antibody	125 KD	Human	WB IHC IF/ICC	200ug	59670
CLSDF3550	Collagen IV α 2 Antibody	150 KD	Human, Mouse	WB IHC IF/ICC	200ug	59670
CLSDF3551	Collagen V α 1 Antibody	200 KD	Human	WB IHC IF/ICC	200ug	59670
CLSDF3552	Collagen VI α 2 Antibody	109 KD	Human, Mouse	WB IHC	200ug	59670
CLSDF3553	Collagen XI α 1 Antibody	181 KD	Human, Mouse	WB	200ug	59670
CLSDF3554	Collagen XIII α 1 Antibody	70 KD	Human, Mouse	WB	200ug	59670
CLSDF3555	Collagen XX α 1 Antibody	140 KD	Human, Mouse,Rat	WB IHC IF/ICC	200ug	59670
CLSDF3556	Collagen XXV α 1 Antibody	64 KD	Human, Mouse	WB	200ug	59670
CLSDF3557	COX11 Antibody	31 KD	Human, Mouse	WB	200ug	59670
CLSDF3558	COX17 Antibody	7 KD	Human, Mouse,Rat	WB IHC	200ug	59670
CLSDF3559	COX41 Antibody	17 KD	Human	WB IHC	200ug	59670
CLSDF3560	COX42 Antibody	20 KD	Human, Mouse,Rat	WB IF/ICC	200ug	59670
CLSDF3561	COX5A Antibody	0 KD	Human, Mouse,Rat	WB IHC	200ug	59670
CLSDF3562	COX6C Antibody	32 KD	Human, Mouse,Rat	WB IF/ICC	200ug	59670
CLSDF3563	Cytochrome P450 17A1 Antibody	50 KD	Human Mouse	WB IHC IF	200ug	59670
CLSDF3564	Cytochrome P450 19A1 Antibody	53 KD	Human, Mouse,Rat	WB IHC IF/ICC	200ug	59670
CLSDF3565	Cytochrome P450 1A1/2 Antibody	58 KD	Human, Mouse,Rat	WB	200ug	59670
CLSDF3566	Cytochrome P450 1A2 Antibody	0 KD	Human, Mouse,Rat	IHC	200ug	59670
CLSDF3567	Cytochrome P450 21A2 Antibody	55 KD	Human	WB	200ug	59670
CLSDF3568	Cytochrome P450 24A1 Antibody	60 KD	Human	WB	200ug	59670
CLSDF3569	Cytochrome P450 26A1 Antibody	56 KD	Human, Mouse,Rat	WB	200ug	59670
CLSDF3570	Cytochrome P450 26C1 Antibody	0 KD	Human	IHC	200ug	59670
CLSDF3571	Cytochrome P450 27A1 Antibody	60 KD	Human	WB	200ug	59670
CLSDF3572	Cytochrome P450 2A6 Antibody	56 KD	Human	WB	200ug	59670
CLSDF3573	Cytochrome P450 2A13 Antibody	56 KD	Human	WB	200ug	59670
CLSDF3574	Cytochrome P450 2B6 Antibody	56 KD	Human	WB	200ug	59670
CLSDF3575	Cytochrome P450 2C8 Antibody	0 KD	Human	IHC	200ug	59670
CLSDF3576	Cytochrome P450 2C8/9/18/19 Antibody	60 KD	Human	WB	200ug	59670
CLSDF3577	Cytochrome P450 2D6 Antibody	55 KD	Human	WB	200ug	59670
CLSDF3578	Cytochrome P450 2E1 Antibody	57 KD	Human, Mouse,Rat	WB IHC IF/ICC	200ug	59670
CLSDF3579	Cytochrome P450 2J2 Antibody	50 KD	Human	WB IHC IF/ICC	200ug	59670



Antibodies

HSN : 38220090

Cat#	Product Description	MW	Reactivity	Application	Pack Size	Unit Price
CLSDF3580	Cytochrome P450 2R1 Antibody	52 KD	Human, Mouse	WB IHC	200ug	59670
CLSDF3581	Cytochrome P450 2S1 Antibody	56 KD	Human, Mouse	WB IHC IF/ICC	200ug	59670
CLSDF3582	Cytochrome P450 2U1 Antibody	61 KD	Human, Mouse,Rat	WB	200ug	59670
CLSDF3583	Cytochrome P450 2W1 Antibody	55 KD	Human	IHC IF/ICC	200ug	59670
CLSDF3584	Cytochrome P450 3A43 Antibody	57 KD	Human	WB	200ug	59670
CLSDF3585	Cytochrome P450 39A1 Antibody	54 KD	Human, Mouse	WB IF/ICC	200ug	59670
CLSDF3586	Cytochrome P450 3A4/5 Antibody	57 KD	Human	WB	200ug	59670
CLSDF3587	Cytochrome P450 3A4 Antibody	0 KD	Human	WB IHC	200ug	59670
CLSDF3588	Cytochrome P450 4B1 Antibody	50 KD	Human	WB IHC	200ug	59670
CLSDF3589	Cytochrome P450 4X1 Antibody	50 KD	Human	WB IHC	200ug	59670
CLSDF3590	Cytochrome P450 4Z1 Antibody	0 KD	Human	IHC IF/ICC	200ug	59670
CLSDF3591	Cytochrome P450 51A1 Antibody	0 KD	Human		200ug	59670
CLSDF3592	Cytochrome P450 7B1 Antibody	58 KD	Human	WB	200ug	59670
CLSDF3593	CYTL1 Antibody	16 KD	Human	WB IHC	200ug	59670
CLSDF3594	DNAJB4 Antibody	38 KD	Human, Mouse,Rat	WB	200ug	59670
CLSDF3595	FGF18 Antibody	0 KD	Human	IHC IF/ICC	200ug	59670
CLSDF3596	FGF23 Antibody	27 KD	Human, Mouse,Rat	IF/ICC	200ug	59670
CLSDF3597	FRS3 Antibody	54 KD	Human	WB	200ug	59670
CLSDF3598	GBP1 Antibody	68 KD	Human	WB IF/ICC	200ug	59670
CLSDF3599	GRID1 Antibody	95 KD	Human, Mouse,Rat	WB IHC	200ug	59670
CLSDF3600	GRID2 Antibody	113 KD	Human, Mouse,Rat	WB IF/ICC	200ug	59670
CLSDF3601	HSPB2 Antibody	24 KD	Human, Mouse,Rat	WB IF/ICC	200ug	59670
CLSDF3602	IL17RA Antibody	90 KD	Human, Mouse	WB	200ug	59670
CLSDF3603	IL20RB Antibody	35 KD	Human, Mouse	WB	200ug	59670
CLSDF3604	MAPK9 Antibody	48 KD	Human, Mouse,Rat	WB	200ug	59670
CLSDF3605	BARD1 Antibody	79 KD	Human	WB	200ug	59670
CLSDF3606	BCL10 Antibody	36 KD	Human, Mouse,Rat	WB IHC	200ug	59670
CLSDF3607	BCLW Antibody	25 KD	Human, Mouse,Rat	WB IF/ICC	200ug	59670
CLSDF3608	CIDEB Antibody	24 KD	Human, Mouse	WB IHC IF/ICC	200ug	59670
CLSDF3609	CYB5 Antibody	15 KD	Human, Mouse,Rat	WB IF/ICC	200ug	59670
CLSDF3610	DAXX Antibody	70 KD	Human, Mouse,Rat	WB IF/ICC	200ug	59670
CLSDF3611	DCC Antibody	158 KD	Human, Mouse,Rat	IF/ICC	200ug	59670
CLSDF3612	DIDO1 Antibody	244 KD	Human, Mouse	WB	200ug	59670
CLSDF3613	DNL4 Antibody	103 KD	Human	WB	200ug	59670
CLSDF3614	ELOA3 Antibody	60 KD	Human	WB	200ug	59670
CLSDF3615	EXO1 Antibody	94 KD	Human, Mouse	WB IF/ICC	200ug	59670
CLSDF3616	EIF4G2 Antibody	90 KD	Human, Mouse	WB	200ug	59670
CLSDF3617	LAMA4 Antibody	203 KD	Human, Mouse	WB IHC IF/ICC	200ug	59670
CLSDF3618	LAMB1 Antibody	220 KD	Human, Mouse	WB IHC IF/ICC	200ug	59670
CLSDF3619	LAMC1 Antibody	178 KD	Human, Mouse,Rat	WB	200ug	59670
CLSDF3620	MGMT Antibody	22 KD	Human,Rat	WB	200ug	59670
CLSDF3621	MLH1 Antibody	85 KD	Human, Mouse,Rat	WB	200ug	59670
CLSDF3622	MLH3 Antibody	164 KD	Human	WB	200ug	59670
CLSDF3623	MRE11A Antibody	81 KD	Human, Mouse,Rat	WB	200ug	59670
CLSDF3624	MSH3 Antibody	127 KD	Human	WB	200ug	59670
CLSDF3625	PARP2 Antibody	75 KD	Human, Mouse	WB	200ug	59670
CLSDF3626	PHLA1 Antibody	40 KD	Human, Mouse,Rat	WB	200ug	59670
CLSDF3627	PMS2 Antibody	85 KD	Human	WB	200ug	59670
CLSDF3628	PRPF19 Antibody	50 KD	Human, Mouse,Rat	WB	200ug	59670
CLSDF3629	RAD51L1 Antibody	45 KD	Human, Mouse	WB IHC	200ug	59670
CLSDF3630	RAD51L3 Antibody	40 KD	Human	WB	200ug	59670
CLSDF3631	RAD54 Antibody	85 KD	Human, Mouse	WB	200ug	59670
CLSDF3632	RAD23A Antibody	48 KD	Human, Mouse	WB	200ug	59670
CLSDF3633	T3JAM Antibody	64 KD	Human, Mouse,Rat	WB IF/ICC	200ug	59670
CLSDF3634	WVOX Antibody	47 KD	Human, Mouse	WB	200ug	59670
CLSDF3635	STAT5A/B Antibody	90 KD	Human, Mouse,Rat	WB	200ug	59670
CLSDF3636	KLF7 Antibody	41 KD	Human, Mouse	WB	200ug	59670
CLSDF3637	ORC1L Antibody	100,120 KD	Human	WB	200ug	59670
CLSDF3638	POU4F3 Antibody	35 KD	Human, Mouse	WB	200ug	59670
CLSDF3639	EFTUD2 Antibody	109 KD	Human, Mouse	WB IHC	200ug	59670
CLSDF3640	AGPAT4 Antibody	44 KD	Human, Mouse,Rat	WB	200ug	59670
CLSDF3641	AGPAT5 Antibody	45 KD	Human	WB	200ug	59670
CLSDF3642	AGPAT3 Antibody	40 KD	Human, Mouse,Rat	WB	200ug	59670
CLSDF3643	PSMD11 Antibody	42 KD	Human, Mouse	WB	200ug	59670
CLSDF3644	PSMD12 Antibody	50 KD	Human, Mouse,Rat	WB	200ug	59670
CLSDF3645	PSMD3 Antibody	61 KD	Human, Mouse,Rat	WB IHC	200ug	59670
CLSDF3646	MRPS12 Antibody	20 KD	Human, Mouse	WB	200ug	59670
CLSDF3647	MRPS16 Antibody	15 KD	Human, Mouse	WB IHC	200ug	59670
CLSDF3648	MRPS17 Antibody	22 KD	Human, Mouse	WB	200ug	59670
CLSDF3649	MRPS18C Antibody	16 KD	Human, Mouse	WB IHC IF/ICC	200ug	59670



Antibodies

HSN : 38220090

Cat#	Product Description	MW	Reactivity	Application	Pack Size	Unit Price
CLSDF3650	MRPS35 Antibody	40 KD	Human	WB	200ug	59670
CLSDF3651	MRPS7 Antibody	24 KD	Human, Mouse,Rat	WB IHC	200ug	59670
CLSDF3652	MRPS9 Antibody	40 KD	Human, Mouse,Rat	WB	200ug	59670
CLSDF3653	HSD3B7 Antibody	41 KD	Human, Mouse,Rat	WB	200ug	59670
CLSDF3654	MRPL54 Antibody	20 KD	Human, Mouse	WB IHC	200ug	59670
CLSDF3655	MRPL10 Antibody	29 KD	Human	WB	200ug	59670
CLSDF3656	MRPL11 Antibody	21 KD	Human	WB IHC IF/ICC	200ug	59670
CLSDF3657	MRPL12 Antibody	21 KD	Human, Mouse	WB	200ug	59670
CLSDF3658	MRPL13 Antibody	24 KD	Human, Mouse,Rat	WB IHC	200ug	59670
CLSDF3659	MRPL14 Antibody	16 KD	Human, Mouse,Rat	WB	200ug	59670
CLSDF3660	MRPL15 Antibody	33 KD	Human, Mouse	WB	200ug	59670
CLSDF3661	MRPL16 Antibody	28 KD	Human	WB IHC	200ug	59670
CLSDF3662	MRPL18 Antibody	21 KD	Human	WB	200ug	59670
CLSDF3663	MRPL20 Antibody	22 KD	Human, Mouse,Rat	WB	200ug	59670
CLSDF3664	MRPL21 Antibody	23 KD	Human, Mouse	WB IHC	200ug	59670
CLSDF3665	MRPL22 Antibody	24 KD	Human, Mouse,Rat	WB	200ug	59670
CLSDF3666	MRPL24 Antibody	32 KD	Human, Mouse,Rat	WB IHC	200ug	59670
CLSDF3667	MRPL32 Antibody	21 KD	Human	WB IF/ICC	200ug	59670
CLSDF3668	MRPL35 Antibody	21 KD	Human, Mouse	WB	200ug	59670
CLSDF3669	MRPL40 Antibody	24 KD	Human	WB IHC	200ug	59670
CLSDF3670	MRPL41 Antibody	21 KD	Human, Mouse,Rat	WB IHC	200ug	59670
CLSDF3671	MRPL44 Antibody	36 KD	Human, Mouse,Rat	WB IHC IF/ICC	200ug	59670
CLSDF3672	MRPL46 Antibody	32 KD	Human, Mouse,Rat	WB IHC	200ug	59670
CLSDF3673	MRPL47 Antibody	30 KD	Human	WB	200ug	59670
CLSDF3674	MRPL51 Antibody	20 KD	Human, Mouse	WB IHC	200ug	59670
CLSDF3675	MRPL9 Antibody	30 KD	Human	WB	200ug	59670
CLSDF3676	RPS11 Antibody	18 KD	Human, Mouse,Rat	WB	200ug	59670
CLSDF3677	RPS12 Antibody	15 KD	Human, Mouse,Rat	WB IF/ICC	200ug	59670
CLSDF3678	RPS15 Antibody	17 KD	Human, Mouse,Rat	WB	200ug	59670
CLSDF3679	RPS18 Antibody	0 KD	Human, Mouse,Rat	WB	200ug	59670
CLSDF3680	RPS19 Antibody	16 KD	Human, Mouse,Rat	WB IHC	200ug	59670
CLSDF3681	RPS20 Antibody	13 KD	Human, Mouse,Rat	WB IF/ICC	200ug	59670
CLSDF3682	RPS23 Antibody	16 KD	Human, Mouse,Rat	WB	200ug	59670
CLSDF3683	RPS27L Antibody	18 KD	Human, Mouse	WB	200ug	59670
CLSDF3684	RPS3 Antibody	30 KD	Human, Mouse,Rat	WB IHC	200ug	59670
CLSDF3685	RPS4X Antibody	30 KD	Human, Mouse,Rat	WB IF/ICC	200ug	59670
CLSDF3686	RPS4Y1 Antibody	29 KD	Human	WB IF/ICC	200ug	59670
CLSDF3687	RPS5 Antibody	22 KD	Human, Mouse,Rat	WB	200ug	59670
CLSDF3688	RPS7 Antibody	22 KD	Human, Mouse,Rat	WB	200ug	59670
CLSDF3689	RPS8 Antibody	30 KD	Human, Mouse,Rat	WB	200ug	59670
CLSDF3690	RPS9 Antibody	23 KD	Human, Mouse,Rat	WB IF/ICC	200ug	59670
CLSDF3691	PRKAG1 Antibody	38 KD	Human, Mouse,Rat	WB	200ug	59670
CLSDF3692	AZ11 Antibody	130 KD	Human	WB IHC	200ug	59670
CLSDF3693	TROVE2 Antibody	70 KD	Human	WB	200ug	59670
CLSDF3694	RPL10A Antibody	25 KD	Human, Mouse,Rat	0	200ug	59670
CLSDF3695	RPL10L Antibody	20 KD	Human	WB	200ug	59670
CLSDF3696	RPL11 Antibody	0 KD	Human, Mouse,Rat	WB	200ug	59670
CLSDF3697	RPL12 Antibody	18 KD	Human, Mouse,Rat	WB	200ug	59670
CLSDF3698	RPL15 Antibody	20 KD	Human, Mouse,Rat	WB	200ug	59670
CLSDF3699	RPL17 Antibody	24 KD	Human, Mouse,Rat	WB IHC	200ug	59670
CLSDF3700	RPL18 Antibody	23 KD	Human, Mouse,Rat	WB	200ug	59670
CLSDF3701	RPL19 Antibody	23 KD	Human, Mouse,Rat	WB	200ug	59670
CLSDF3702	RPL23 Antibody	15 KD	Human, Mouse,Rat	WB IHC	200ug	59670
CLSDF3703	RPL26L Antibody	20 KD	Human, Mouse,Rat	WB	200ug	59670
CLSDF3704	RPL27A Antibody	20 KD	Human, Mouse,Rat	WB IF/ICC	200ug	59670
CLSDF3705	RPL28 Antibody	20 KD	Human, Mouse,Rat	WB	200ug	59670
CLSDF3706	RPL3 Antibody	46 KD	Human, Mouse,Rat	WB IHC	200ug	59670
CLSDF3707	RPL30 Antibody	13 KD	Human, Mouse,Rat	WB IHC	200ug	59670
CLSDF3708	RPL34 Antibody	13 KD	Human, Mouse,Rat	WB IF/ICC	200ug	59670
CLSDF3709	RPL35 Antibody	18 KD	Human, Mouse,Rat	WB	200ug	59670
CLSDF3710	RPL36 Antibody	12 KD	Human, Mouse,Rat	WB IHC IF/ICC	200ug	59670
CLSDF3711	RPL39 Antibody	6 KD	Human, Mouse,Rat	WB IF/ICC	200ug	59670
CLSDF3712	RPL5 Antibody	34 KD	Human, Mouse,Rat	WB	200ug	59670
CLSDF3713	RPL7 Antibody	32 KD	Human, Mouse,Rat	WB	200ug	59670
CLSDF3714	PGD Antibody	40 KD	Human, Mouse,Rat	WB	200ug	59670
CLSDF3715	PGLS Antibody	30 KD	Human	WB IHC	200ug	59670
CLSDF3716	ABHD11 Antibody	32 KD	Human	WB	200ug	59670
CLSDF3717	ABHD12 Antibody	45 KD	Human, Mouse,Rat	WB	200ug	59670
CLSDF3718	ABHD14A Antibody	30 KD	Human, Mouse,Rat	WB	200ug	59670
CLSDF3719	ABHD2 Antibody	48 KD	Human, Mouse	WB IF/ICC	200ug	59670



Antibodies

HSN : 38220090

Cat#	Product Description	MW	Reactivity	Application	Pack Size	Unit Price
CLSDF3720	ABHD6 Antibody	38 KD	Human, Mouse,Rat	WB IF/ICC	200ug	59670
CLSDF3721	ABHD7 Antibody	42 KD	Human, Mouse	WB	200ug	59670
CLSDF3722	ABHD8 Antibody	45 KD	Human, Mouse	WB	200ug	59670
CLSDF3723	ABHD9 Antibody	38 KD	Human	WB	200ug	59670
CLSDF3724	CHRN1 Antibody	55 KD	Human, Mouse,Rat	WB	200ug	59670
CLSDF3725	ACHE Antibody	70 KD	Human, Mouse,Rat	WB	200ug	59670
CLSDF3726	ACAT1 Antibody	45 KD	Human, Mouse,Rat	WB	200ug	59670
CLSDF3727	ACSS1 Antibody	75 KD	Human, Mouse	WB IHC	200ug	59670
CLSDF3728	ACSA Antibody	0 KD	Human, Mouse,Rat		200ug	59670
CLSDF3729	SLC33A1 Antibody	0 KD	Human		200ug	59670
CLSDF3730	ANP32B Antibody	29 KD	Human, Mouse,Rat	WB	200ug	59670
CLSDF3731	ACTR3 Antibody	47 KD	Human, Mouse,Rat	WB	200ug	59670
CLSDF3732	ACBD6 Antibody	30 KD	Human, Mouse,Rat	WB	200ug	59670
CLSDF3733	ACOT1 Antibody	46 KD	Human	WB IF/ICC	200ug	59670
CLSDF3734	ACOT2 Antibody	53 KD	Human	WB	200ug	59670
CLSDF3735	ACOT4 Antibody	48 KD	Human	WB IF/ICC	200ug	59670
CLSDF3736	ACOT8 Antibody	36 KD	Human	WB IF/ICC	200ug	59670
CLSDF3737	LYPLA1 Antibody	25 KD	Human, Mouse,Rat	WB	200ug	59670
CLSDF3738	LPCAT2 Antibody	50 KD	Human, Mouse,Rat	WB	200ug	59670
CLSDF3739	ADAM32 Antibody	0 KD	Human	WB	200ug	59670
CLSDF3740	ADAMTS18 Antibody	135 KD	Human, Mouse	WB	200ug	59670
CLSDF3741	ADAMTS19 Antibody	140 KD	Human, Mouse	WB	200ug	59670
CLSDF3742	SLC25A6 Antibody	32 KD	Human	WB	200ug	59670
CLSDF3743	SLC25A31 Antibody	35 KD	Human, Mouse	WB	200ug	59670
CLSDF3744	BST1 Antibody	34 KD	Human, Mouse,Rat	WB	200ug	59670
CLSDF3745	ARF4 Antibody	25 KD	Human	WB	200ug	59670
CLSDF3746	ARF6 Antibody	0 KD	Human, Mouse,Rat	WB	200ug	59670
CLSDF3747	ARFGAP1 Antibody	60 48 KD	Human, Mouse,Rat	WB IF/ICC	200ug	59670
CLSDF3748	ARFGAP3 Antibody	0 KD	Human	WB	200ug	59670
CLSDF3749	ARL2BP Antibody	25 KD	Human, Mouse,Rat	WB	200ug	59670
CLSDF3750	AGXT2L2 Antibody	50 KD	Human, Mouse,Rat	WB	200ug	59670
CLSDF3751	AARSD1 Antibody	45 KD	Human, Mouse,Rat	WB	200ug	59670
CLSDF3752	AKR1A1 Antibody	0 KD	Human, Mouse,Rat	WB	200ug	59670
CLSDF3753	ADH7 Antibody	40 KD	Human	WB	200ug	59670
CLSDF3754	ALDH3B1 Antibody	52 KD	Human	WB IHC	200ug	59670
CLSDF3755	ALDH1B1 Antibody	57 KD	Human	WB	200ug	59670
CLSDF3756	AOX1 Antibody	120 KD	Human,Rat	WB IHC	200ug	59670
CLSDF3757	AKR1C2 Antibody	37 KD	Human	WB	200ug	59670
CLSDF3758	AKR1CL2 Antibody	37 KD	Human	WB	200ug	59670
CLSDF3759	AKR1B1 Antibody	36 KD	Human,Rat	WB	200ug	59670
CLSDF3760	ASAH3L Antibody	33 KD	Human, Mouse	WB	200ug	59670
CLSDF3761	PHCA Antibody	35 KD	Human, Mouse	WB IHC IF/ICC	200ug	59670
CLSDF3762	A4GNT Antibody	39 KD	Human	WB	200ug	59670
CLSDF3763	AASS Antibody	102 KD	Human	WB	200ug	59670
CLSDF3764	SGCA Antibody	43 KD	Human, Mouse	WB	200ug	59670
CLSDF3765	SCNN1D Antibody	70 KD	Human	WB IF/ICC	200ug	59670
CLSDF3766	AMPD2 Antibody	100 KD	Human, Mouse,Rat	WB	200ug	59670
CLSDF3767	AMPH Antibody	76 KD	Human, Mouse,Rat	WB	200ug	59670
CLSDF3768	APBA3 Antibody	61 KD	Human	WB	200ug	59670
CLSDF3769	APBB2 Antibody	83 KD	Human, Mouse	WB IHC	200ug	59670
CLSDF3770	NECAB3 Antibody	44 KD	Human, Mouse	WB IF/ICC	200ug	59670
CLSDF3771	APPBP2 Antibody	67 KD	Human, Mouse,Rat	WB	200ug	59670
CLSDF3772	APLP2 Antibody	87 KD	Human, Mouse,Rat	WB	200ug	59670
CLSDF3773	ALS2CR11 Antibody	71 KD	Human	WB	200ug	59670
CLSDF3774	ALS2CR4 Antibody	48 KD	Human, Mouse	WB	200ug	59670
CLSDF3775	ALS2CR8 Antibody	85 KD	Human	WB IHC	200ug	59670
CLSDF3776	ALS2CR13 Antibody	60 KD	Human, Mouse	WB	200ug	59670
CLSDF3777	AIG1 Antibody	32 KD	Human	WB	200ug	59670
CLSDF3778	ANGPTL7 Antibody	50 KD	Human, Mouse	WB	200ug	59670
CLSDF3779	ANXA10 Antibody	38 KD	Human, Mouse	WB	200ug	59670
CLSDF3780	KAL1 Antibody	76 KD	Human	WB	200ug	59670
CLSDF3781	AIBP Antibody	30 KD	Human, Mouse,Rat	WB IF/ICC	200ug	59670
CLSDF3782	APOA4 Antibody	0 KD	Human	0	200ug	59670
CLSDF3783	APOA5 Antibody	41 KD	Human	WB	200ug	59670
CLSDF3784	APOF Antibody	38 KD	Human	WB	200ug	59670
CLSDF3785	APOL1 Antibody	44 KD	Human	WB	200ug	59670
CLSDF3786	APOL2 Antibody	37 KD	Human	WB IHC IF/ICC	200ug	59670
CLSDF3787	APOL4 Antibody	34 KD	Human	WB IHC IF/ICC	200ug	59670
CLSDF3788	AQP1 Antibody	29 KD	Human, Mouse,Rat	WB	200ug	59670

Antibodies

HSN : 38220090

Cat#	Product Description	MW	Reactivity	Application	Pack Size	Unit Price
CLSDF3789	AQP12 Antibody	34 KD	Human	WB	200ug	59670
CLSDF3790	ARFIP1 Antibody	40 KD	Human, Mouse,Rat	WB IF/ICC	200ug	59670
CLSDF3791	ARG1 Antibody	35 KD	Human	WB	200ug	59670
CLSDF3792	ARG2 Antibody	38 KD	Human	WB	200ug	59670
CLSDF3793	ARMC6 Antibody	54 KD	Human, Mouse,Rat	WB IF/ICC	200ug	59670
CLSDF3794	ARSA Antibody	54 KD	Human, Mouse,Rat	WB IHC	200ug	59670
CLSDF3795	ARSE Antibody	0 KD	Human	WB	200ug	59670
CLSDF3796	ARSF Antibody	60 KD	Human	WB	200ug	59670
CLSDF3797	ARSG Antibody	65 KD	Human, Mouse,Rat	WB IHC	200ug	59670
CLSDF3798	ARSI Antibody	64 KD	Human	WB IF/ICC	200ug	59670
CLSDF3799	ATXN2 Antibody	140 KD	Human	WB	200ug	59670
CLSDF3800	ATXN2L Antibody	113 KD	Human	WB	200ug	59670
CLSDF3801	ATXN7L2 Antibody	0 KD	Human, Mouse,Rat	WB	200ug	59670
CLSDF3802	ATP5H Antibody	26 KD	Human, Mouse,Rat	WB	200ug	59670
CLSDF3803	ATP5I Antibody	8 KD	Human	WB	200ug	59670
CLSDF3804	ATPG Antibody	33 KD	Human, Mouse,Rat	WB	200ug	59670
CLSDF3805	ATPAF2 Antibody	35 KD	Human, Mouse	WB	200ug	59670
CLSDF3806	ATP5A1 Antibody	60 KD	Human, Mouse,Rat	WB	200ug	59670
CLSDF3807	ATP5L2 Antibody	20 KD	Human	WB IF/ICC	200ug	59670
CLSDF3808	ATP5S Antibody	23 KD	Human, Mouse	WB	200ug	59670
CLSDF3809	ABCA6 Antibody	0 KD	Human	WB	200ug	59670
CLSDF3810	ABCA8 Antibody	179 KD	Human, Mouse	WB	200ug	59670
CLSDF3811	ABCB10 Antibody	79 KD	Human	WB	200ug	59670
CLSDF3812	ABCB7 Antibody	83 KD	Human	WB IHC	200ug	59670
CLSDF3813	ABCD1 Antibody	75 KD	Human	WB	200ug	59670
CLSDF3814	ABCD4 Antibody	70 KD	Human, Mouse	WB IHC	200ug	59670
CLSDF3815	ABCF1 Antibody	0 KD	Human, Mouse,Rat	WB	200ug	59670
CLSDF3816	ABCF2 Antibody	71 KD	Human, Mouse,Rat	WB	200ug	59670
CLSDF3817	DDX19B Antibody	50 KD	Human, Mouse	WB	200ug	59670
CLSDF3818	DDX50 Antibody	0 KD	Human, Mouse	WB	200ug	59670
CLSDF3819	DDX51 Antibody	72 KD	Human	WB	200ug	59670
CLSDF3820	DDX54 Antibody	98 KD	Human	WB	200ug	59670
CLSDF3821	DDX55 Antibody	68 KD	Human, Mouse	WB	200ug	59670
CLSDF3822	DHX8 Antibody	150 KD	Human, Mouse	WB	200ug	59670
CLSDF3823	DQX1 Antibody	79 KD	Human, Mouse	WB	200ug	59670
CLSDF3824	ATN1 Antibody	130 KD	Human, Mouse,Rat	WB	200ug	59670
CLSDF3825	ATG16L1 Antibody	0 KD	Human	WB	200ug	59670
CLSDF3826	EPB41L2 Antibody	0 KD	Human	WB IHC	200ug	59670
CLSDF3827	BNIP2 Antibody	36 KD	Human	WB	200ug	59670
CLSDF3828	BCLAF1 Antibody	106 KD	Human, Mouse,Rat	WB	200ug	59670
CLSDF3829	BOK Antibody	0 KD	Human, Mouse,Rat	0	200ug	59670
CLSDF3830	BCL2L12 Antibody	34 KD	Human, Mouse	WB	200ug	59670
CLSDF3831	GCNT6 Antibody	45 KD	Human	WB	200ug	59670
CLSDF3832	GCNT7 Antibody	49 KD	Human	WB IHC IF/ICC	200ug	59670
CLSDF3833	B3GALT1 Antibody	36 KD	Human, Mouse	WB	200ug	59670
CLSDF3834	B3GALT4 Antibody	42 KD	Human	WB	200ug	59670
CLSDF3835	B3GALT1 Antibody	57 KD	Human	WB IHC	200ug	59670
CLSDF3836	LFNG Antibody	42 KD	Human, Mouse,Rat	WB	200ug	59670
CLSDF3837	MFNG Antibody	38 KD	Human, Mouse,Rat	WB	200ug	59670
CLSDF3838	B4GALNT1 Antibody	60 KD	Human, Mouse,Rat	WB	200ug	59670
CLSDF3839	B4GALT1 Antibody	0 KD	Human, Mouse	WB IHC	200ug	59670
CLSDF3840	B4GALT3 Antibody	49 KD	Human, Mouse,Rat	WB IHC	200ug	59670
CLSDF3841	B4GALT5 Antibody	40 KD	Human, Mouse	WB	200ug	59670
CLSDF3842	GLB1 Antibody	76 KD	Human	WB	200ug	59670
CLSDF3843	GUSB Antibody	78 KD	Human, Mouse,Rat	WB	200ug	59670
CLSDF3844	GUSBL1 Antibody	18 KD	Human	WB	200ug	59670
CLSDF3845	SLC27A5 Antibody	75 KD	Human	WB IHC IF/ICC	200ug	59670
CLSDF3846	BST2 Antibody	22 KD	Human	WB	200ug	59670
CLSDF3847	BMP10 Antibody	0 KD	Human	WB	200ug	59670
CLSDF3848	BMP3 Antibody	55 KD	Human	WB	200ug	59670
CLSDF3849	BMP8A Antibody	45 KD	Human	WB IF/ICC	200ug	59670
CLSDF3850	BMP8B Antibody	45 KD	Human	WB	200ug	59670
CLSDF3851	BRP16 Antibody	40 KD	Human, Mouse,Rat	WB IHC	200ug	59670
CLSDF3852	BRP44L Antibody	12 KD	Human, Mouse,Rat	WB IHC IF/ICC	200ug	59670
CLSDF3853	BAIAP2L1 Antibody	57 KD	Human, Mouse,Rat	WB	200ug	59670
CLSDF3854	BAIAP2L2 Antibody	52 KD	Human, Mouse	WB	200ug	59670
CLSDF3855	BCAS2 Antibody	27 KD	Human, Mouse,Rat	WB	200ug	59670
CLSDF3856	BCAS4 Antibody	23 KD	Human	WB IHC	200ug	59670
CLSDF3857	ARFGF2 Antibody	210 KD	Human, Mouse,Rat	WB IF/ICC	200ug	59670
CLSDF3858	BAZ2A Antibody	210 KD	Human	WB	200ug	59670

Antibodies
HSN : 38220090

Cat#	Product Description	MW	Reactivity	Application	Pack Size	Unit Price
CLSDF3859	BRWD3 Antibody	204 KD	Human, Mouse	WB IHC	200ug	59670
CLSDF3860	CHP2 Antibody	22 KD	Human, Mouse,Rat	WB	200ug	59670
CLSDF3861	RCAN1 Antibody	22 KD	Human, Mouse,Rat	WB	200ug	59670
CLSDF3862	KCNMB2 Antibody	30 KD	Human, Mouse,Rat	WB	200ug	59670
CLSDF3863	CABP7 Antibody	25 KD	Human, Mouse,Rat	WB IHC	200ug	59670
CLSDF3864	CHP Antibody	0 KD	Human, Mouse,Rat	WB	200ug	59670
CLSDF3865	PNPLA8 Antibody	88 KD	Human, Mouse	WB	200ug	59670
CLSDF3866	CAPN10 Antibody	0 KD	Human	WB	200ug	59670
CLSDF3867	CAPN11 Antibody	81 KD	Human	WB	200ug	59670
CLSDF3868	CAPN12 Antibody	80 KD	Human	WB	200ug	59670
CLSDF3869	CAPN9 Antibody	79 KD	Human	WB	200ug	59670
CLSDF3870	CNN2 Antibody	33 KD	Human, Mouse	WB IF/ICC	200ug	59670
CLSDF3871	ARPP21 Antibody	80 KD	Human, Mouse	WB IHC	200ug	59670
CLSDF3872	PDE4C Antibody	80 KD	Human, Mouse,Rat	WB	200ug	59670
CLSDF3873	ABCC2 Antibody	174 KD	Human	WB	200ug	59670
CLSDF3874	ABCC3 Antibody	170 KD	Human	WB	200ug	59670
CLSDF3875	CAGE1 Antibody	90 KD	Human	WB IHC	200ug	59670
CLSDF3876	CLIP1 Antibody	161 KD	Human, Mouse,Rat	WB	200ug	59670
CLSDF3877	CLIP2 Antibody	120 KD	Human, Mouse,Rat	WB	200ug	59670
CLSDF3878	CLIP3 Antibody	60 KD	Human, Mouse,Rat	WB IF/ICC	200ug	59670
CLSDF3879	CLIP4 Antibody	76 KD	Human	WB	200ug	59670
CLSDF3880	CHST1 Antibody	0 KD	Human, Mouse,Rat	WB	200ug	59670
CLSDF3881	CHST10 Antibody	48 KD	Human, Mouse,Rat	WB IHC	200ug	59670
CLSDF3882	CHST13 Antibody	39 KD	Human	WB IHC	200ug	59670
CLSDF3883	CHST2 Antibody	58 KD	Human	WB	200ug	59670
CLSDF3884	CHST8 Antibody	40 KD	Human, Mouse,Rat	WB	200ug	59670
CLSDF3885	CA1 Antibody	29 KD	Human	WB IHC	200ug	59670
CLSDF3886	CA12 Antibody	39 KD	Human, Mouse,Rat	WB	200ug	59670
CLSDF3887	CA13 Antibody	35 KD	Human, Mouse	WB	200ug	59670
CLSDF3888	CA14 Antibody	34 KD	Human, Mouse,Rat	WB	200ug	59670
CLSDF3889	CA3 Antibody	38 KD	Human, Mouse,Rat	WB	200ug	59670
CLSDF3890	CA5A Antibody	35 KD	Human	WB	200ug	59670
CLSDF3891	CA5B Antibody	38 KD	Human, Mouse,Rat	WB IF/ICC	200ug	59670
CLSDF3892	CA6 Antibody	35 KD	Human	WB	200ug	59670
CLSDF3893	CBR1 Antibody	32 KD	Human	WB IHC	200ug	59670
CLSDF3894	CBR3 Antibody	31 KD	Human, Mouse,Rat	WB IHC	200ug	59670
CLSDF3895	CES2 Antibody	0 KD	Human	WB IHC	200ug	59670
CLSDF3896	CPA5 Antibody	50 KD	Human, Mouse	WB	200ug	59670
CLSDF3897	CPB2 Antibody	48 KD	Human	WB	200ug	59670
CLSDF3898	CPE Antibody	53 KD	Human, Mouse,Rat	WB	200ug	59670
CLSDF3899	CPM Antibody	51 KD	Human	WB	200ug	59670
CLSDF3900	CPN1 Antibody	52 KD	Human	WB	200ug	59670
CLSDF3901	CPN2 Antibody	0 KD	Human	WB	200ug	59670
CLSDF3902	CTDSP1 Antibody	30 KD	Human, Mouse,Rat	WB IHC	200ug	59670
CLSDF3903	CEACAM21 Antibody	32 KD	Human	WB	200ug	59670
CLSDF3904	CPT1B Antibody	88 KD	Human	WB IHC	200ug	59670
CLSDF3905	COMT Antibody	30 KD	Human	WB	200ug	59670
CLSDF3906	SLC7A4 Antibody	68 KD	Human	WB	200ug	59670
CLSDF3907	CNOT4 Antibody	64 KD	Human, Mouse,Rat	WB IHC	200ug	59670
CLSDF3908	BORG1 Antibody	28 KD	Human, Mouse,Rat	WB	200ug	59670
CLSDF3909	BORG2 Antibody	0 KD	Human, Mouse,Rat	WB	200ug	59670
CLSDF3910	BORG4 Antibody	36 KD	Human	WB	200ug	59670
CLSDF3911	BORG3 Antibody	22 KD	Human, Mouse	WB	200ug	59670
CLSDF3912	CGREF1 Antibody	31 KD	Human	WB IHC	200ug	59670
CLSDF3913	LYAR Antibody	44 KD	Human	WB	200ug	59670
CLSDF3914	CRABP2 Antibody	16 KD	Human, Mouse,Rat	WB	200ug	59670
CLSDF3915	CEP290 Antibody	290 KD	Human, Mouse	WB	200ug	59670
CLSDF3916	CEP135 Antibody	134 KD	Human, Mouse	WB	200ug	59670
CLSDF3917	CEP170 Antibody	160 KD	Human	WB IHC	200ug	59670
CLSDF3918	CEP55 Antibody	54 KD	Human	WB	200ug	59670
CLSDF3919	CEP57 Antibody	50 KD	Human	WB	200ug	59670
CLSDF3920	CEP70 Antibody	70 KD	Human	WB	200ug	59670
CLSDF3921	CEP76 Antibody	74 KD	Human, Mouse	WB	200ug	59670
CLSDF3922	CEP78 Antibody	80 KD	Human, Mouse	WB IHC	200ug	59670
CLSDF3923	CBLN1 Antibody	25 KD	Human, Mouse,Rat	WB	200ug	59670
CLSDF3924	CBLN2 Antibody	24 KD	Human, Mouse,Rat	WB	200ug	59670
CLSDF3925	CBLN4 Antibody	27 KD	Human, Mouse	WB IHC	200ug	59670
CLSDF3926	HUCE1 Antibody	51 KD	Human	WB	200ug	59670
CLSDF3927	CLN5 Antibody	46 KD	Human, Mouse,Rat	WB	200ug	59670
CLSDF3928	CLN6 Antibody	40 KD	Human	WB IHC	200ug	59670

Antibodies

HSN : 38220090

Cat#	Product Description	MW	Reactivity	Application	Pack Size	Unit Price
CLSDF3929	CNGA1 Antibody	79 KD	Human, Mouse,Rat	WB	200ug	59670
CLSDF3930	CLCC1 Antibody	62 KD	Human	WB IF/ICC	200ug	59670
CLSDF3931	CLCN4 Antibody	85 KD	Human, Mouse,Rat	WB IF/ICC	200ug	59670
CLSDF3932	CLCN7 Antibody	89 KD	Human, Mouse,Rat	WB	200ug	59670
CLSDF3933	CLCNKA Antibody	75 KD	Human	WB	200ug	59670
CLSDF3934	CLIC6 Antibody	73 KD	Human	WB	200ug	59670
CLSDF3935	CLIC3 Antibody	27 KD	Human	WB	200ug	59670
CLSDF3936	CLIC4 Antibody	29 KD	Human, Mouse,Rat	WB IHC	200ug	59670
CLSDF3937	CSGLCAT Antibody	86 KD	Human	WB	200ug	59670
CLSDF3938	CSPG5 Antibody	60 KD	Human, Mouse,Rat	WB	200ug	59670
CLSDF3939	CHSY1 Antibody	91 KD	Human, Mouse	WB IHC	200ug	59670
CLSDF3940	CHSY2 Antibody	85 KD	Human, Mouse,Rat	WB IHC IF/ICC	200ug	59670
CLSDF3941	KIF4A Antibody	140 KD	Human	WB	200ug	59670
CLSDF3942	CKLF2 Antibody	27 KD	Human	WB	200ug	59670
CLSDF3943	CKLF3 Antibody	22 KD	Human	WB	200ug	59670
CLSDF3944	CKLF6 Antibody	25 KD	Human	WB	200ug	59670
CLSDF3945	CLDN19 Antibody	23 KD	Human,Rat	WB	200ug	59670
CLSDF3946	CLDN6 Antibody	26 KD	Human	WB IHC IF/ICC	200ug	59670
CLSDF3947	CLDN8 Antibody	28 KD	Human	WB	200ug	59670
CLSDF3948	CSTF2T Antibody	64 KD	Human, Mouse,Rat	WB	200ug	59670
CLSDF3949	CLASP1 Antibody	169 KD	Human, Mouse	WB IHC	200ug	59670
CLSDF3950	ST6GAL1 Antibody	42 KD	Human, Mouse,Rat	WB IHC	200ug	59670
CLSDF3951	RCL Antibody	22 KD	Human	WB	200ug	59670
CLSDF3952	COPZ1 Antibody	20 KD	Human, Mouse	WB IHC	200ug	59670
CLSDF3953	CCDC102A Antibody	55 KD	Human, Mouse	WB	200ug	59670
CLSDF3954	CCDC102B Antibody	60 KD	Human	WB IHC	200ug	59670
CLSDF3955	BEND4 Antibody	57 KD	Human	WB	200ug	59670
CLSDF3956	CCDC45 Antibody	95 KD	Human, Mouse,Rat	WB	200ug	59670
CLSDF3957	CCDC99 Antibody	70 KD	Human	WB	200ug	59670
CLSDF3958	C1QB Antibody	28 KD	Human	WB IF/ICC	200ug	59670
CLSDF3959	C1QC Antibody	30 KD	Human, Mouse,Rat	WB IHC	200ug	59670
CLSDF3960	C1QL2 Antibody	32-36 KD	Human, Mouse	WB	200ug	59670
CLSDF3961	C1S Antibody	77 KD	Human	WB IHC	200ug	59670
CLSDF3962	C1QBP Antibody	32 KD	Human, Mouse,Rat	WB IHC	200ug	59670
CLSDF3963	C6 Antibody	105 KD	Human,Rat	WB IHC	200ug	59670
CLSDF3964	C9 Antibody	70 KD	Human	WB	200ug	59670
CLSDF3965	CD55 Antibody	41 KD	Human	WB	200ug	59670
CLSDF3966	CFI Antibody	66 KD	Human	WB	200ug	59670
CLSDF3967	NCAPH Antibody	83 KD	Human	WB	200ug	59670
CLSDF3968	NCAPG Antibody	114 KD	Human	WB	200ug	59670
CLSDF3969	CNTN2 Antibody	120 KD	Human, Mouse,Rat	WB	200ug	59670
CLSDF3970	CNTN6 Antibody	115 KD	Human, Mouse	WB	200ug	59670
CLSDF3971	CCS Antibody	32 KD	Human	WB	200ug	59670
CLSDF3972	HSD11B1 Antibody	32 KD	Human, Mouse,Rat	WB IHC	200ug	59670
CLSDF3973	CXADR Antibody	40 KD	Human, Mouse,Rat	WB	200ug	59670
CLSDF3974	CNGB1 Antibody	102 KD	Human, Mouse,Rat	WB	200ug	59670
CLSDF3975	CST11 Antibody	17 KD	Human	WB	200ug	59670
CLSDF3976	ATG4C Antibody	49 KD	Human	WB IHC IF/ICC	200ug	59670
CLSDF3977	ATG4A Antibody	0 KD	Human	WB IHC	200ug	59670
CLSDF3978	NT5C1A Antibody	41 KD	Human, Mouse	WB IF/ICC	200ug	59670
CLSDF3979	GBA3 Antibody	54-58 KD	Human	WB	200ug	59670
CLSDF3980	CBCP2 Antibody	104 KD	Human, Mouse	WB IHC	200ug	59670
CLSDF3981	AGBL4 Antibody	62 KD	Human	WB	200ug	59670
CLSDF3982	PLA2G4C Antibody	70 KD	Human	WB	200ug	59670
CLSDF3983	APPL1 Antibody	80 KD	Human, Mouse	WB	200ug	59670
CLSDF3984	DOCK1 Antibody	215 KD	Human, Mouse	WB	200ug	59670
CLSDF3985	DHRS2 Antibody	27 KD	Human, Mouse	WB	200ug	59670
CLSDF3986	DHRS4 Antibody	32-34 KD	Human	WB IHC	200ug	59670
CLSDF3987	DHPS Antibody	45 KD	Human	WB	200ug	59670
CLSDF3988	DSG2 Antibody	140 KD	Human	WB	200ug	59670
CLSDF3989	DGAT2L6 Antibody	36 KD	Human	WB	200ug	59670
CLSDF3990	DKK3 Antibody	45 KD	Human, Mouse	WB	200ug	59670
CLSDF3991	DHODH Antibody	48 KD	Human	WB IHC	200ug	59670
CLSDF3992	DPYSL4 Antibody	62 KD	Human, Mouse,Rat	WB	200ug	59670
CLSDF3993	GNPAT Antibody	77 KD	Human	WB	200ug	59670
CLSDF3994	DMGDH Antibody	97 KD	Human	WB	200ug	59670
CLSDF3995	DLG2 Antibody	98 KD	Human	WB IHC	200ug	59670
CLSDF3996	DNTT Antibody	58 KD	Human	WB	200ug	59670
CLSDF3997	POLD1 Antibody	125 KD	Human, Mouse,Rat	WB	200ug	59670
CLSDF3998	POLI Antibody	85 KD	Human	WB	200ug	59670

Antibodies
HSN : 38220090

Cat#	Product Description	MW	Reactivity	Application	Pack Size	Unit Price
CLSDF3999	POLD3 Antibody	51 KD	Human, Mouse,Rat	WB	200ug	59670
CLSDF4000	PRIM1 Antibody	50 KD	Human, Mouse,Rat	WB	200ug	59670
CLSDF4001	RPA2 Antibody	0 KD	Human, Mouse,Rat	WB IHC	200ug	59670
CLSDF4002	CD3EAP Antibody	55 KD	Human	WB	200ug	59670
CLSDF4003	RPB11 Antibody	13 KD	Human, Mouse	WB	200ug	59670
CLSDF4004	RPC1 Antibody	156 KD	Human, Mouse	WB	200ug	59670
CLSDF4005	RPC3 Antibody	60 KD	Human	WB	200ug	59670
CLSDF4006	RPC4 Antibody	38 KD	Human, Mouse	WB	200ug	59670
CLSDF4007	RPC8 Antibody	23 KD	Human, Mouse,Rat	WB	200ug	59670
CLSDF4008	POLR1C Antibody	39 KD	Human, Mouse	WB	200ug	59670
CLSDF4009	RPAB1 Antibody	25 KD	Human, Mouse,Rat	WB	200ug	59670
CLSDF4010	DNAJB11 Antibody	40 KD	Human, Mouse,Rat	WB IHC	200ug	59670
CLSDF4011	DNAJC5 Antibody	30 KD	Human, Mouse,Rat	WB	200ug	59670
CLSDF4012	TESK1 Antibody	68 KD	Human, Mouse,Rat	WB	200ug	59670
CLSDF4013	DNAI2 Antibody	69 KD	Human, Mouse,Rat	WB	200ug	59670
CLSDF4014	DNAL1 Antibody	22 KD	Human, Mouse	WB	200ug	59670
CLSDF4015	RNF111 Antibody	109 KD	Human, Mouse	WB	200ug	59670
CLSDF4016	CCNB1IP1 Antibody	32 KD	Human	WB	200ug	59670
CLSDF4017	DZIP3 Antibody	139 KD	Human	WB IHC	200ug	59670
CLSDF4018	HECW2 Antibody	140-150 KD	Human	WB	200ug	59670
CLSDF4019	MARCH3 Antibody	29 KD	Human, Mouse,Rat	WB IHC	200ug	59670
CLSDF4020	MYLIP Antibody	50 KD	Human, Mouse,Rat	WB IHC	200ug	59670
CLSDF4021	PJA2 Antibody	85 KD	Human	WB	200ug	59670
CLSDF4022	RAD18 Antibody	56 KD	Human,Rat	WB	200ug	59670
CLSDF4023	RFWD2 Antibody	80 KD	Human, Mouse	WB	200ug	59670
CLSDF4024	RNF125 Antibody	26 KD	Human, Mouse,Rat	WB	200ug	59670
CLSDF4025	RNF138 Antibody	28 KD	Human, Mouse,Rat	WB	200ug	59670
CLSDF4026	RNF14 Antibody	50 KD	Human, Mouse,Rat	WB	200ug	59670
CLSDF4027	RNF144A Antibody	30 KD	Human, Mouse	WB	200ug	59670
CLSDF4028	RNF144B Antibody	0 KD	Human, Mouse	WB	200ug	59670
CLSDF4029	UBR1 Antibody	36 KD	Human, Mouse	WB	200ug	59670
CLSDF4030	INSL4 Antibody	19 KD	Human	WB IF/ICC	200ug	59670
CLSDF4031	ENTPD1 Antibody	65 KD	Human	WB	200ug	59670
CLSDF4032	EFEMP1 Antibody	55 KD	Human, Mouse,Rat	WB	200ug	59670
CLSDF4033	EFEMP2 Antibody	50 KD	Human	WB IHC IF/ICC	200ug	59670
CLSDF4034	EEF1G Antibody	55 KD	Human, Mouse,Rat	WB	200ug	59670
CLSDF4035	GFM2 Antibody	87 KD	Human	WB IF/ICC	200ug	59670
CLSDF4036	ELOVL1 Antibody	35 KD	Human, Mouse	WB	200ug	59670
CLSDF4037	ELOVL4 Antibody	37 KD	Human, Mouse	WB	200ug	59670
CLSDF4038	ELOVL5 Antibody	28 KD	Human	WB IHC	200ug	59670
CLSDF4039	ELOVL6 Antibody	35 KD	Human, Mouse,Rat	WB	200ug	59670
CLSDF4040	ENDOGL1 Antibody	41 KD	Human	WB	200ug	59670
CLSDF4041	NEIL1 Antibody	44 KD	Human	WB	200ug	59670
CLSDF4042	NEIL3 Antibody	68 KD	Human, Mouse	WB	200ug	59670
CLSDF4043	MAN1B1 Antibody	80 KD	Human	WB	200ug	59670
CLSDF4044	EPHA10 Antibody	110 KD	Human, Mouse	WB	200ug	59670
CLSDF4045	EPN2 Antibody	68 KD	Human, Mouse,Rat	WB	200ug	59670
CLSDF4046	EPN3 Antibody	68 KD	Human	WB IHC	200ug	59670
CLSDF4047	ERD22 Antibody	24 KD	Human, Mouse,Rat	WB IF/ICC	200ug	59670
CLSDF4048	ERD23 Antibody	28 KD	Human, Mouse	WB	200ug	59670
CLSDF4049	HSD17B2 Antibody	0 KD	Human	0	200ug	59670
CLSDF4050	EIF2S2 Antibody	40 KD	Human	WB	200ug	59670
CLSDF4051	EIF2AK1 Antibody	71 KD	Human, Mouse	WB	200ug	59670
CLSDF4052	EIF3K Antibody	30 KD	Human, Mouse	WB	200ug	59670
CLSDF4053	EIF3F Antibody	38 KD	Human, Mouse,Rat	WB IHC	200ug	59670
CLSDF4054	EIF3D Antibody	64 KD	Human, Mouse	WB IHC	200ug	59670
CLSDF4055	EIF5B Antibody	139 KD	Human, Mouse,Rat	WB	200ug	59670
CLSDF4056	FBLN5 Antibody	50 KD	Human, Mouse,Rat	WB	200ug	59670
CLSDF4057	FKBPL Antibody	38 KD	Human, Mouse,Rat	WB	200ug	59670
CLSDF4058	FOLR1 Antibody	34 KD	Human, Mouse,Rat	WB	200ug	59670
CLSDF4059	FOXB2 Antibody	46 KD	Human, Mouse	WB	200ug	59670
CLSDF4060	FOXD4 Antibody	0 KD	Human, Mouse	WB	200ug	59670
CLSDF4061	FOXD4L1 Antibody	45 KD	Human	WB	200ug	59670
CLSDF4062	FOXD4/L2/L3/L4/L5/L6 Antibody	46 KD	Human	WB	200ug	59670
CLSDF4063	FOXN4 Antibody	50 KD	Human	WB	200ug	59670
CLSDF4064	ALDOB Antibody	39 KD	Human, Mouse,Rat	WB	200ug	59670
CLSDF4065	GPS2 Antibody	40 KD	Human, Mouse,Rat	WB	200ug	59670
CLSDF4066	KCNJ9 Antibody	44 KD	Human, Mouse,Rat	WB	200ug	59670
CLSDF4067	GPRIN1 Antibody	102 KD	Human	WB	200ug	59670
CLSDF4068	FUT3 Antibody	42 KD	Human	WB IHC	200ug	59670



Antibodies

HSN : 38220090

Cat#	Product Description	MW	Reactivity	Application	Pack Size	Unit Price
CLSDF4069	GABRA4 Antibody	62 KD	Human, Mouse,Rat	WB	200ug	59670
CLSDF4070	GABRA6 Antibody	51 KD	Human, Mouse,Rat	WB	200ug	59670
CLSDF4071	GABRD Antibody	51 KD	Human, Mouse,Rat	WB	200ug	59670
CLSDF4072	GABRG1 Antibody	54 KD	Human, Mouse,Rat	WB	200ug	59670
CLSDF4073	GGH Antibody	36 KD	Human	WB	200ug	59670
CLSDF4074	IFI16 Antibody	88 KD	Human	WB	200ug	59670
CLSDF4075	TUBGCP4 Antibody	76 KD	Human, Mouse	WB	200ug	59670
CLSDF4076	TUBGCP5 Antibody	118 KD	Human, Mouse,Rat	WB	200ug	59670
CLSDF4077	TUBGCP6 Antibody	200 KD	Human	WB IHC	200ug	59670
CLSDF4078	CXG2 Antibody	47 KD	Human	WB IF/ICC	200ug	59670
CLSDF4079	GJA4 Antibody	37 KD	Human, Mouse,Rat	WB	200ug	59670
CLSDF4080	GJC1 Antibody	45 KD	Human, Mouse,Rat	WB	200ug	59670
CLSDF4081	GJB7 Antibody	24 KD	Human	WB	200ug	59670
CLSDF4082	GJC3 Antibody	28 KD	Human	WB	200ug	59670
CLSDF4083	GCF Antibody	80 KD	Human	WB	200ug	59670
CLSDF4084	POFUT1 Antibody	44 KD	Human, Mouse,Rat	WB IHC	200ug	59670
CLSDF4085	TSTA3 Antibody	40 KD	Human, Mouse,Rat	WB	200ug	59670
CLSDF4086	GRIN2D Antibody	170 KD	Human, Mouse,Rat	WB	200ug	59670
CLSDF4087	GSTT1/4 Antibody	30 KD	Human	WB	200ug	59670
CLSDF4088	GLRB Antibody	56 KD	Human, Mouse,Rat	WB	200ug	59670
CLSDF4089	GORASP2 Antibody	47 KD	Human, Mouse,Rat	WB	200ug	59670
CLSDF4090	GRAP2 Antibody	38 KD	Human	WB	200ug	59670
CLSDF4091	GRB14 Antibody	61 KD	Human, Mouse,Rat	WB	200ug	59670
CLSDF4092	GRB2 Antibody	32 KD	Human, Mouse,Rat	WB	200ug	59670
CLSDF4093	GHITM Antibody	37 KD	Human	WB	200ug	59670
CLSDF4094	GRTP1 Antibody	35 KD	Human	WB	200ug	59670
CLSDF4095	GIDRP88 Antibody	88 KD	Human, Mouse	WB IHC	200ug	59670
CLSDF4096	GDF15 Antibody	37 KD	Human	WB	200ug	59670
CLSDF4097	GDF7 Antibody	47 KD	Human	WB	200ug	59670
CLSDF4098	GAS1 Antibody	36 KD	Human, Mouse	WB	200ug	59670
CLSDF4099	ERAS Antibody	25 KD	Human	WB IF/ICC	200ug	59670
CLSDF4100	GIMAP2 Antibody	38 KD	Human	WB IF/ICC	200ug	59670
CLSDF4101	GIMAP4 Antibody	38 KD	Human	WB	200ug	59670
CLSDF4102	GIMAP5 Antibody	35 KD	Human	WB IHC	200ug	59670
CLSDF4103	DIRA1 Antibody	22 KD	Human	WB	200ug	59670
CLSDF4104	RAD Antibody	33 KD	Human	WB IHC IF/ICC	200ug	59670
CLSDF4105	SAR1B Antibody	22 KD	Human, Mouse,Rat	WB IHC	200ug	59670
CLSDF4106	GNA14 Antibody	42 KD	Human, Mouse,Rat	WB	200ug	59670
CLSDF4107	GNAI3 Antibody	41 KD	Human, Mouse,Rat	WB	200ug	59670
CLSDF4108	GNAL Antibody	40 KD	Human, Mouse,Rat	WB IHC	200ug	59670
CLSDF4109	GNAT1 Antibody	36 KD	Human, Mouse,Rat	WB	200ug	59670
CLSDF4110	GNAT2 Antibody	40 KD	Human, Mouse	WB	200ug	59670
CLSDF4111	GNB5 Antibody	40 KD	Human, Mouse,Rat	WB IHC	200ug	59670
CLSDF4112	GNL1 Antibody	69 KD	Human, Mouse,Rat	WB	200ug	59670
CLSDF4113	GNL3L Antibody	66 KD	Human	WB	200ug	59670
CLSDF4114	GBP3 Antibody	64 KD	Human	WB	200ug	59670
CLSDF4115	HNRCL Antibody	32 KD	Human	WB	200ug	59670
CLSDF4116	HNRPLL Antibody	60 KD	Human, Mouse,Rat	WB	200ug	59670
CLSDF4117	HLAH Antibody	40 KD	Human	WB	200ug	59670
CLSDF4118	HLA-DOA Antibody	34 KD	Human	WB	200ug	59670
CLSDF4119	HLA-DOB Antibody	31 KD	Human	WB	200ug	59670
CLSDF4120	HLA-DPA1 Antibody	0 KD	Human	WB	200ug	59670
CLSDF4121	EMX1 Antibody	28 KD	Human, Mouse,Rat	WB	200ug	59670
CLSDF4122	HOXA11/D11 Antibody	28 KD	Human, Mouse	WB IF/ICC	200ug	59670
CLSDF4123	HOXA5 Antibody	0 KD	Human, Mouse,Rat	WB	200ug	59670
CLSDF4124	HOXA6 Antibody	26 KD	Human	WB	200ug	59670
CLSDF4125	HOXB2 Antibody	38 KD	Human	WB	200ug	59670
CLSDF4126	MSX2 Antibody	0 KD	Human, Mouse	WB IHC	200ug	59670
CLSDF4127	NKX24 Antibody	40 KD	Human	WB	200ug	59670
CLSDF4128	NKX26 Antibody	28 KD	Human	WB	200ug	59670
CLSDF4129	SIX1 Antibody	33 KD	Human, Mouse	WB	200ug	59670
CLSDF4130	SIX5 Antibody	75 KD	Human, Mouse	WB	200ug	59670
CLSDF4131	ICAM2 Antibody	30 KD	Human	WB	200ug	59670
CLSDF4132	KCNN4 Antibody	48 KD	Human, Mouse,Rat	WB	200ug	59670
CLSDF4133	IQCB1 Antibody	69 KD	Human	WB	200ug	59670
CLSDF4134	AASDHPPPT Antibody	36 KD	Human, Mouse,Rat	WB	200ug	59670
CLSDF4135	DCT Antibody	60 KD	Human, Mouse	WB IF/ICC	200ug	59670
CLSDF4136	LRG1 Antibody	37 KD	Human	WB	200ug	59670
CLSDF4137	CEP97 Antibody	97 KD	Human, Mouse	WB	200ug	59670
CLSDF4138	LRRRC41 Antibody	80 KD	Human, Mouse,Rat	WB	200ug	59670



Antibodies

HSN : 38220090

Cat#	Product Description	MW	Reactivity	Application	Pack Size	Unit Price
CLSDF4139	LILRA1 Antibody	53 KD	Human	WB IF/ICC	200ug	59670
CLSDF4140	LILRA2 Antibody	53 KD	Human	WB	200ug	59670
CLSDF4141	LIP1 Antibody	53 KD	Human	WB	200ug	59670
CLSDF4142	ACSL6 Antibody	78 KD	Human, Mouse,Rat	WB	200ug	59670
CLSDF4143	LDLRAD1 Antibody	26 KD	Human	WB	200ug	59670
CLSDF4144	LDLRAD2 Antibody	29 KD	Human	WB	200ug	59670
CLSDF4145	LRP11 Antibody	50 KD	Human	WB	200ug	59670
CLSDF4146	LRP3 Antibody	80 KD	Human, Mouse,Rat	WB	200ug	59670
CLSDF4147	LFA3 Antibody	28 KD	Human	WB	200ug	59670
CLSDF4148	LSP1 Antibody	37 KD	Human	WB	200ug	59670
CLSDF4149	MRC1 Antibody	166 KD	Human, Mouse,Rat	WB	200ug	59670
CLSDF4150	MAD2L1BP Antibody	0 KD	Human	WB	200ug	59670
CLSDF4151	MASP2 Antibody	75 KD	Human	WB	200ug	59670
CLSDF4152	MBL2 Antibody	27 KD	Human, Mouse	WB	200ug	59670
CLSDF4153	MED18 Antibody	24 KD	Human, Mouse,Rat	WB	200ug	59670
CLSDF4154	MED8 Antibody	0 KD	Human, Mouse,Rat	WB	200ug	59670
CLSDF4155	REC8 Antibody	62 KD	Human	WB	200ug	59670
CLSDF4156	MIA2 Antibody	62 KD	Human	WB	200ug	59670
CLSDF4157	GSDMC Antibody	58 KD	Human	WB	200ug	59670
CLSDF4158	PGRMC2 Antibody	25 KD	Human, Mouse,Rat	WB	200ug	59670
CLSDF4159	MBTPS1 Antibody	0 KD	Human, Mouse,Rat	WB	200ug	59670
CLSDF4160	CLNS1A Antibody	37 KD	Human	WB	200ug	59670
CLSDF4161	MGST1 Antibody	18 KD	Human	WB	200ug	59670
CLSDF4162	MGST2 Antibody	0 KD	Human	WB	200ug	59670
CLSDF4163	MAP9 Antibody	74 KD	Human	WB	200ug	59670
CLSDF4164	MRPS2 Antibody	33 KD	Human	WB IHC	200ug	59670
CLSDF4165	MRPS21 Antibody	11 KD	Human, Mouse,Rat	WB IHC IF/ICC	200ug	59670
CLSDF4166	MRPS22 Antibody	41 KD	Human	WB IF/ICC	200ug	59670
CLSDF4167	MRPS25 Antibody	20 KD	Human, Mouse,Rat	WB	200ug	59670
CLSDF4168	MRPS27 Antibody	48 KD	Human	WB	200ug	59670
CLSDF4169	MRPS30 Antibody	55 KD	Human	WB	200ug	59670
CLSDF4170	MRPS34 Antibody	26 KD	Human, Mouse	WB	200ug	59670
CLSDF4171	MRPS36 Antibody	15 KD	Human	WB IHC	200ug	59670
CLSDF4172	SLC25A21 Antibody	36 KD	Human, Mouse,Rat	WB IHC	200ug	59670
CLSDF4173	SLC25A11 Antibody	35 KD	Human, Mouse,Rat	WB	200ug	59670
CLSDF4174	MRPL3 Antibody	0 KD	Human	WB	200ug	59670
CLSDF4175	MRPL39 Antibody	39 KD	Human	WB IHC	200ug	59670
CLSDF4176	MRPL4 Antibody	35 KD	Human, Mouse	WB	200ug	59670
CLSDF4177	MRPL49 Antibody	0 KD	Human	WB IHC	200ug	59670
CLSDF4178	MRPL50 Antibody	22 KD	Human	WB	200ug	59670
CLSDF4179	TOMM20 Antibody	17 KD	Human, Mouse,Rat	WB	200ug	59670
CLSDF4180	MOT13 Antibody	40 KD	Human	WB	200ug	59670
CLSDF4181	MOT14 Antibody	48 KD	Human, Mouse	WB	200ug	59670
CLSDF4182	MOT4 Antibody	49 KD	Human, Mouse,Rat	WB	200ug	59670
CLSDF4183	SLC16A2 Antibody	60 KD	Human, Mouse,Rat	WB	200ug	59670
CLSDF4184	MPHOSPH9 Antibody	78 KD	Human	WB	200ug	59670
CLSDF4185	MRP7 Antibody	162 KD	Human	WB	200ug	59670
CLSDF4186	MRP9 Antibody	170 KD	Human	WB	200ug	59670
CLSDF4187	MEGF8 Antibody	255 KD	Human	WB	200ug	59670
CLSDF4188	MEGF9 Antibody	63 KD	Human, Mouse,Rat	WB	200ug	59670
CLSDF4189	MINPP1 Antibody	60 KD	Human, Mouse,Rat	WB	200ug	59670
CLSDF4190	MAZ Antibody	48 KD	Human, Mouse,Rat	WB	200ug	59670
CLSDF4191	MNDA Antibody	46 KD	Human	WB	200ug	59670
CLSDF4192	MLF1 Antibody	30 KD	Human, Mouse	WB	200ug	59670
CLSDF4193	MDF1 Antibody	25 KD	Human, Mouse	WB	200ug	59670
CLSDF4194	MB Antibody	0 KD	Human	WB	200ug	59670
CLSDF4195	MYOM2 Antibody	165 KD	Human, Mouse	WB	200ug	59670
CLSDF4196	MYH14 Antibody	228 KD	Human, Mouse	WB	200ug	59670
CLSDF4197	MYH15 Antibody	225 KD	Human	WB	200ug	59670
CLSDF4198	MYBPC1 Antibody	120 KD	Human, Mouse,Rat	WB	200ug	59670
CLSDF4199	MYO9B Antibody	250 KD	Human, Mouse,Rat	WB	200ug	59670
CLSDF4200	MYO5A Antibody	220 KD	Human, Mouse,Rat	WB	200ug	59670
CLSDF4201	SLC9A3R2 Antibody	37 KD	Human, Mouse,Rat	WB	200ug	59670
CLSDF4202	NACAD Antibody	140 KD	Human	WB	200ug	59670
CLSDF4203	NDUFA4 Antibody	9 KD	Human, Mouse,Rat	WB	200ug	59670
CLSDF4204	NDUFA4L2 Antibody	15 KD	Human, Mouse	WB	200ug	59670
CLSDF4205	NDUFA8 Antibody	22 KD	Human, Mouse	WB IHC	200ug	59670
CLSDF4206	NDUFA9 Antibody	40 KD	Human, Mouse,Rat	WB	200ug	59670
CLSDF4207	NDUFB10 Antibody	24 KD	Human	WB	200ug	59670
CLSDF4208	NDUFB9 Antibody	22 KD	Human	WB	200ug	59670



Antibodies

HSN : 38220090

Cat#	Product Description	MW	Reactivity	Application	Pack Size	Unit Price
CLSDF4209	NDUFV2 Antibody	27 KD	Human, Mouse,Rat	WB	200ug	59670
CLSDF4210	NDUFS3 Antibody	40 KD	Human, Mouse	WB	200ug	59670
CLSDF4211	CYB5R1 Antibody	34 KD	Human, Mouse,Rat	WB	200ug	59670
CLSDF4212	CYB5R3 Antibody	34 KD	Human	WB IHC	200ug	59670
CLSDF4213	NDUFS1 Antibody	79 KD	Human, Mouse,Rat	WB IHC	200ug	59670
CLSDF4214	MT-ND1 Antibody	36 KD	Human	WB IHC	200ug	59670
CLSDF4215	MT-ND5 Antibody	70 KD	Human	WB	200ug	59670
CLSDF4216	PTGR1 Antibody	36 KD	Human	WB	200ug	59670
CLSDF4217	ME1 Antibody	64 KD	Human, Mouse,Rat	WB	200ug	59670
CLSDF4218	ME3 Antibody	67 KD	Human, Mouse	WB	200ug	59670
CLSDF4219	NOX5 Antibody	86 KD	Human	WB	200ug	59670
CLSDF4220	NCR1 Antibody	40 KD	Human	WB	200ug	59670
CLSDF4221	NCR3 Antibody	30 KD	Human,Rat	WB	200ug	59670
CLSDF4222	N4BP1 Antibody	100 KD	Human	WB	200ug	59670
CLSDF4223	C14orf49 Antibody	130 KD	Human, Mouse	WB	200ug	59670
CLSDF4224	NCAM2 Antibody	100 KD	Human, Mouse,Rat	WB	200ug	59670
CLSDF4225	NPDC1 Antibody	28 KD	Human, Mouse,Rat	WB	200ug	59670
CLSDF4226	NRL Antibody	26 KD	Human, Mouse	WB	200ug	59670
CLSDF4227	NEURL2 Antibody	36 KD	Human, Mouse	WB IHC	200ug	59670
CLSDF4228	NRSN1 Antibody	25 KD	Human, Mouse,Rat	WB	200ug	59670
CLSDF4229	NRXN3 Antibody	70 KD	Human	WB	200ug	59670
CLSDF4230	NXPH1 Antibody	31 KD	Human, Mouse,Rat	WB IHC	200ug	59670
CLSDF4231	NXPH3 Antibody	30 KD	Human, Mouse,Rat	WB	200ug	59670
CLSDF4232	NXPH4 Antibody	33 KD	Human,Rat	WB IHC	200ug	59670
CLSDF4233	NBPF1/9/10/12/14/15/16/20 Antibody	36 KD	Human	WB	200ug	59670
CLSDF4234	NBPF5 Antibody	41 KD	Human	WB	200ug	59670
CLSDF4235	NBPF7 Antibody	48 KD	Human	WB	200ug	59670
CLSDF4236	NCAN Antibody	0 KD	Human	WB	200ug	59670
CLSDF4237	NMS Antibody	24 KD	Human	WB	200ug	59670
CLSDF4238	NMU Antibody	22 KD	Human	WB IHC	200ug	59670
CLSDF4239	CHRNA10 Antibody	50 KD	Human, Mouse,Rat	WB	200ug	59670
CLSDF4240	NEGR1 Antibody	35 KD	Human, Mouse,Rat	WB	200ug	59670
CLSDF4241	SEPT3 Antibody	41 KD	Human, Mouse,Rat	WB	200ug	59670
CLSDF4242	NSG1 Antibody	26 KD	Human, Mouse,Rat	WB	200ug	59670
CLSDF4243	PNPLA6 Antibody	150 KD	Human, Mouse	WB	200ug	59670
CLSDF4244	VGF Antibody	67 KD	Human, Mouse,Rat	WB IHC	200ug	59670
CLSDF4245	NT Antibody	42 KD	Human	WB	200ug	59670
CLSDF4246	NLE1 Antibody	48 KD	Human	WB	200ug	59670
CLSDF4247	SP100 Antibody	0 KD	Human	WB IHC	200ug	59670
CLSDF4248	PPP1R8 Antibody	40 KD	Human, Mouse,Rat	WB	200ug	59670
CLSDF4249	NUMA1 Antibody	240 KD	Human	WB IHC	200ug	59670
CLSDF4250	NUP107 Antibody	0 KD	Human, Mouse,Rat	WB	200ug	59670
CLSDF4251	NUP160 Antibody	140 KD	Human, Mouse	WB	200ug	59670
CLSDF4252	NUP93 Antibody	93 KD	Human, Mouse,Rat	WB	200ug	59670
CLSDF4253	NARFL Antibody	50 KD	Human	WB	200ug	59670
CLSDF4254	HCC1 Antibody	30 KD	Human, Mouse,Rat	WB IHC	200ug	59670
CLSDF4255	NCOA4 Antibody	70 KD	Human, Mouse,Rat	WB IHC	200ug	59670
CLSDF4256	NCOA7 Antibody	106 KD	Human	WB	200ug	59670
CLSDF4257	NRBF2 Antibody	36 KD	Human, Mouse,Rat	WB	200ug	59670
CLSDF4258	NXF3 Antibody	60 KD	Human	WB	200ug	59670
CLSDF4259	NFYC Antibody	50 KD	Human, Mouse,Rat	WB	200ug	59670
CLSDF4260	NUTF2 Antibody	14 KD	Human, Mouse,Rat	WB IHC	200ug	59670
CLSDF4261	NUSAP1 Antibody	49 KD	Human	WB	200ug	59670
CLSDF4262	NOC2L Antibody	85 KD	Human, Mouse,Rat	WB	200ug	59670
CLSDF4263	NOC3L Antibody	93 KD	Human, Mouse	WB	200ug	59670
CLSDF4264	NOLC1 Antibody	0 KD	Human, Mouse,Rat	WB	200ug	59670
CLSDF4265	NOL10 Antibody	80 KD	Human	WB	200ug	59670
CLSDF4266	SLC15A1 Antibody	37 KD	Human, Mouse,Rat	WB	200ug	59670
CLSDF4267	OGFR Antibody	80 KD	Human	WB	200ug	59670
CLSDF4268	SLC22A3 Antibody	61 KD	Human	WB	200ug	59670
CLSDF4269	SLC22A5 Antibody	65 KD	Human	WB	200ug	59670
CLSDF4270	OAT Antibody	0 KD	Human, Mouse,Rat	WB	200ug	59670
CLSDF4271	NR4A3 Antibody	65 KD	Human, Mouse,Rat	WB	200ug	59670
CLSDF4272	SLC6A15 Antibody	85 KD	Human	WB	200ug	59670
CLSDF4273	PDRG1 Antibody	19 KD	Human, Mouse,Rat	WB	200ug	59670
CLSDF4274	PRRX1 Antibody	0 KD	Human, Mouse,Rat	WB	200ug	59670
CLSDF4275	ZDHHC15 Antibody	38 KD	Human	WB	200ug	59670
CLSDF4276	ZDHHC7 Antibody	35 KD	Human	WB	200ug	59670
CLSDF4277	PARD6B Antibody	38 KD	Human, Mouse	WB	200ug	59670
CLSDF4278	DECR2 Antibody	36 KD	Human, Mouse,Rat	WB	200ug	59670



Antibodies

HSN : 38220090

Cat#	Product Description	MW	Reactivity	Application	Pack Size	Unit Price
CLSDF4279	PECI Antibody	40 KD	Human	WB IHC	200ug	59670
CLSDF4280	EHHADH Antibody	80 KD	Human,Rat	WB IHC	200ug	59670
CLSDF4281	PEX19 Antibody	33 KD	Human	WB	200ug	59670
CLSDF4282	PEX3 Antibody	42 KD	Human, Mouse,Rat	WB	200ug	59670
CLSDF4283	PEX11B Antibody	28 KD	Human, Mouse,Rat	WB	200ug	59670
CLSDF4284	PEX14 Antibody	38 KD	Human, Mouse,Rat	WB IHC	200ug	59670
CLSDF4285	PRIC285 Antibody	295 KD	Human	WB	200ug	59670
CLSDF4286	PEX7 Antibody	40 KD	Human, Mouse,Rat	WB IHC	200ug	59670
CLSDF4287	PXMP3 Antibody	35 KD	Human	WB IHC	200ug	59670
CLSDF4288	PEX10 Antibody	45 KD	Human	WB IHC	200ug	59670
CLSDF4289	PHACTR4 Antibody	80 KD	Human	WB	200ug	59670
CLSDF4290	PEBP1 Antibody	23 KD	Human	WB	200ug	59670
CLSDF4291	PITPNB Antibody	32 KD	Human, Mouse,Rat	WB	200ug	59670
CLSDF4292	PIP5K1C Antibody	80 KD	Human	WB	200ug	59670
CLSDF4293	PIGX Antibody	26 KD	Human	WB	200ug	59670
CLSDF4294	PLD4 Antibody	50 KD	Human, Mouse,Rat	WB	200ug	59670
CLSDF4295	N4BP2L2 Antibody	67 KD	Human, Mouse	WB	200ug	59670
CLSDF4296	PNN Antibody	85 KD	Human, Mouse	WB	200ug	59670
CLSDF4297	PKP2 Antibody	97 KD	Human,Rat	WB	200ug	59670
CLSDF4298	PKP4 Antibody	130 KD	Human, Mouse	WB IHC	200ug	59670
CLSDF4299	SERPIN1 Antibody	55 KD	Human	WB IHC	200ug	59670
CLSDF4300	Serpin A5 Antibody	42 KD	Human	WB	200ug	59670
CLSDF4301	PVRL3 Antibody	61 KD	Human, Mouse	WB	200ug	59670
CLSDF4302	PVRL4 Antibody	55 KD	Human	WB	200ug	59670
CLSDF4303	PABPC5 Antibody	43 KD	Human	WB	200ug	59670
CLSDF4304	POLDIP3 Antibody	46 KD	Human	WB	200ug	59670
CLSDF4305	KCNK1 Antibody	38 KD	Human,Rat	WB	200ug	59670
CLSDF4306	KCNK12 Antibody	47 KD	Human, Mouse,Rat	WB	200ug	59670
CLSDF4307	KCNK15 Antibody	42 KD	Human	WB IHC	200ug	59670
CLSDF4308	KCNK17 Antibody	40 KD	Human	WB	200ug	59670
CLSDF4309	KCNK4 Antibody	45 KD	Human, Mouse	WB	200ug	59670
CLSDF4310	KCNK6 Antibody	0 KD	Human	WB	200ug	59670
CLSDF4311	KCNK7 Antibody	0 KD	Human	WB	200ug	59670
CLSDF4312	KCNA1 Antibody	57 KD	Human, Mouse,Rat	WB	200ug	59670
CLSDF4313	KCNA5 Antibody	68 KD	Human, Mouse,Rat	WB	200ug	59670
CLSDF4314	KCNC1 Antibody	60 KD	Human, Mouse,Rat	WB	200ug	59670
CLSDF4315	KCND1 Antibody	70 KD	Human, Mouse	WB	200ug	59670
CLSDF4316	KCNF1 Antibody	55 KD	Human, Mouse	WB	200ug	59670
CLSDF4317	KCNG2 Antibody	51 KD	Human, Mouse,Rat	WB	200ug	59670
CLSDF4318	KCNG3 Antibody	50 KD	Human, Mouse,Rat	WB	200ug	59670
CLSDF4319	KCNH1 Antibody	111 KD	Human, Mouse,Rat	WB	200ug	59670
CLSDF4320	KCNH3 Antibody	0 KD	Human, Mouse,Rat	WB	200ug	59670
CLSDF4321	KCNQ4 Antibody	80 KD	Human, Mouse	WB	200ug	59670
CLSDF4322	KCNQ5 Antibody	100 KD	Human, Mouse	WB	200ug	59670
CLSDF4323	KCNS2 Antibody	54 KD	Human, Mouse,Rat	WB	200ug	59670
CLSDF4324	KCNV2 Antibody	62 KD	Human, Mouse	WB	200ug	59670
CLSDF4325	SF3B14 Antibody	20 KD	Human, Mouse	WB	200ug	59670
CLSDF4326	CDC40 Antibody	66 KD	Human, Mouse,Rat	WB	200ug	59670
CLSDF4327	PRPF39 Antibody	74 KD	Human, Mouse	WB	200ug	59670
CLSDF4328	PRPF18 Antibody	40 KD	Human, Mouse,Rat	WB	200ug	59670
CLSDF4329	PRPF38A Antibody	40 KD	Human, Mouse	WB	200ug	59670
CLSDF4330	SLU7 Antibody	65 KD	Human, Mouse,Rat	WB	200ug	59670
CLSDF4331	PSAP Antibody	58 KD	Human	WB	200ug	59670
CLSDF4332	DDX20 Antibody	92 KD	Human, Mouse	WB	200ug	59670
CLSDF4333	DDX52 Antibody	67 KD	Human	WB	200ug	59670
CLSDF4334	APOBEC3D/F Antibody	40 KD	Human	WB IHC	200ug	59670
CLSDF4335	ZDHHC20 Antibody	37 KD	Human, Mouse,Rat	WB	200ug	59670
CLSDF4336	BTC Antibody	0 KD	Human	WB	200ug	59670
CLSDF4337	A26B1 Antibody	60 KD	Human	WB	200ug	59670
CLSDF4338	FAM35A/B Antibody	94 KD	Human	WB	200ug	59670
CLSDF4339	FNTB Antibody	49 KD	Human, Mouse,Rat	WB	200ug	59670
CLSDF4340	NDRG3 Antibody	45 KD	Human, Mouse,Rat	WB IHC	200ug	59670
CLSDF4341	NDRG4 Antibody	34 KD	Human, Mouse,Rat	WB IHC	200ug	59670
CLSDF4342	PPP1R16B Antibody	64 KD	Human, Mouse	WB	200ug	59670
CLSDF4343	PPP1R14D Antibody	24 KD	Human	WB	200ug	59670
CLSDF4344	PPP1R16A Antibody	60 KD	Human	WB	200ug	59670
CLSDF4345	PPP1R3A Antibody	140 KD	Human	WB	200ug	59670
CLSDF4346	PPP1R3C Antibody	36 KD	Human	WB	200ug	59670
CLSDF4347	PPP1R7 Antibody	48 KD	Human	WB	200ug	59670
CLSDF4348	PPM1K Antibody	45 KD	Human, Mouse	WB IHC	200ug	59670



Antibodies

HSN : 38220090

Cat#	Product Description	MW	Reactivity	Application	Pack Size	Unit Price
CLSDF4349	PPM1L Antibody	48 KD	Human, Mouse,Rat	WB	200ug	59670
CLSDF4350	SSH3 Antibody	74 KD	Human, Mouse,Rat	WB IHC	200ug	59670
CLSDF4351	PMS2/PMS2CL Antibody	0 KD	Human	IHC	200ug	59670
CLSDF4352	RED Antibody	66 KD	Human, Mouse,Rat	WB	200ug	59670
CLSDF4353	S100A16 Antibody	20 KD	Human,Rat	WB	200ug	59670
CLSDF4354	S100A3 Antibody	0 KD	Human, Mouse,Rat	IHC	200ug	59670
CLSDF4355	S100A5 Antibody	32 KD	Human, Mouse,Rat	WB	200ug	59670
CLSDF4356	S100A7L2 Antibody	11 KD	Human	WB	200ug	59670
CLSDF4357	S100Z Antibody	12 KD	Human	WB	200ug	59670
CLSDF4358	PLEKHG4 Antibody	135 KD	Human	WB	200ug	59670
CLSDF4359	ABCC13 Antibody	31 KD	Human	WB IHC	200ug	59670
CLSDF4360	APOBEC4 Antibody	40 KD	Human	WB	200ug	59670
CLSDF4361	MOV10L1 Antibody	140 KD	Human	WB	200ug	59670
CLSDF4362	PWWP2B Antibody	64 KD	Human	WB	200ug	59670
CLSDF4363	PDXDC1 Antibody	87 KD	Human, Mouse,Rat	WB	200ug	59670
CLSDF4364	PC Antibody	120 KD	Human, Mouse,Rat	WB IHC	200ug	59670
CLSDF4365	PDK1 Antibody	0 KD	Human, Mouse,Rat	WB	200ug	59670
CLSDF4366	PDK2 Antibody	46 KD	Human, Mouse,Rat	WB	200ug	59670
CLSDF4367	PDHA1 Antibody	43 KD	Human, Mouse,Rat	WB IHC	200ug	59670
CLSDF4368	RABEP2 Antibody	64 KD	Human, Mouse,Rat	WB	200ug	59670
CLSDF4369	CHML Antibody	85 KD	Human	WB IHC	200ug	59670
CLSDF4370	RAB11FIP2 Antibody	58 KD	Human, Mouse	WB	200ug	59670
CLSDF4371	RAB3GAP1 Antibody	117 KD	Human	WB IHC	200ug	59670
CLSDF4372	RAB3GAP2 Antibody	156 KD	Human, Mouse,Rat	WB IHC	200ug	59670
CLSDF4373	ZFYVE20 Antibody	89 KD	Human, Mouse	WB	200ug	59670
CLSDF4374	RABL2A Antibody	30-34 KD	Human	WB	200ug	59670
CLSDF4375	RSAD1 Antibody	52 KD	Human, Mouse	WB IHC	200ug	59670
CLSDF4376	RDX Antibody	69 KD	Human, Mouse,Rat	WB	200ug	59670
CLSDF4377	RFTN1 Antibody	63 KD	Human	WB	200ug	59670
CLSDF4378	REPS1 Antibody	80 KD	Human	WB	200ug	59670
CLSDF4379	RANBP17 Antibody	125 KD	Human, Mouse	WB	200ug	59670
CLSDF4380	RANBP6 Antibody	125 KD	Human, Mouse,Rat	WB	200ug	59670
CLSDF4381	RAPGEF3 Antibody	110/100 KD	Human, Mouse,Rat	WB	200ug	59670
CLSDF4382	RAPGEF5 Antibody	60 KD	Human, Mouse,Rat	WB	200ug	59670
CLSDF4383	RAP1GAP Antibody	0 KD	Human, Mouse	WB IHC	200ug	59670
CLSDF4384	RIN1 Antibody	84 KD	Human, Mouse,Rat	WB	200ug	59670
CLSDF4385	RASSF6 Antibody	45 KD	Human	WB	200ug	59670
CLSDF4386	RASA3 Antibody	96 KD	Human, Mouse,Rat	WB	200ug	59670
CLSDF4387	G3BP2 Antibody	55 KD	Human, Mouse,Rat	WB	200ug	59670
CLSDF4388	IQGAP1 Antibody	190 KD	Human, Mouse	WB	200ug	59670
CLSDF4389	IQGAP3 Antibody	180 KD	Human, Mouse,Rat	WB	200ug	59670
CLSDF4390	RASL10A Antibody	30 KD	Human, Mouse	WB	200ug	59670
CLSDF4391	RASL10B Antibody	22 KD	Human, Mouse	WB	200ug	59670
CLSDF4392	RRAGA/B Antibody	34 KD	Human, Mouse,Rat	WB	200ug	59670
CLSDF4393	RRAGB Antibody	0 KD	Human, Mouse,Rat	WB	200ug	59670
CLSDF4394	RRAGC Antibody	44 KD	Human, Mouse,Rat	WB	200ug	59670
CLSDF4395	RAB18 Antibody	28 KD	Human, Mouse,Rat	WB	200ug	59670
CLSDF4396	RAB20 Antibody	28 KD	Human	WB	200ug	59670
CLSDF4397	RAB20 Antibody	28 KD	Human	WB	200ug	59670
CLSDF4398	RAB26 Antibody	0 KD	Human, Mouse,Rat	0	200ug	59670
CLSDF4399	RAB2A Antibody	25 KD	Human, Mouse,Rat	WB IHC	200ug	59670
CLSDF4400	RAB2B Antibody	24 KD	Human, Mouse,Rat	WB	200ug	59670
CLSDF4401	RAB31 Antibody	21 KD	Human, Mouse,Rat	WB	200ug	59670
CLSDF4402	RAB33A Antibody	27 KD	Human, Mouse,Rat	WB	200ug	59670
CLSDF4403	RAB37 Antibody	22 KD	Human	WB IHC	200ug	59670
CLSDF4404	RAB38 Antibody	26 KD	Human, Mouse,Rat	WB	200ug	59670
CLSDF4405	RAB40B Antibody	34 KD	Human	WB	200ug	59670
CLSDF4406	RAB5C Antibody	30 KD	Human, Mouse,Rat	WB	200ug	59670
CLSDF4407	RAB6A Antibody	24 KD	Human, Mouse,Rat	WB	200ug	59670
CLSDF4408	RAB6C Antibody	28 KD	Human, Mouse,Rat	WB	200ug	59670
CLSDF4409	RAB7L1 Antibody	28 KD	Human, Mouse,Rat	WB	200ug	59670
CLSDF4410	RAP2B Antibody	18 KD	Human, Mouse,Rat	WB	200ug	59670
CLSDF4411	RAP2C Antibody	26 KD	Human, Mouse	WB	200ug	59670
CLSDF4412	PTPRZ1 Antibody	250 KD	Human, Mouse,Rat	WB	200ug	59670
CLSDF4413	RGS1 Antibody	22 KD	Human, Mouse,Rat	WB IHC	200ug	59670
CLSDF4414	RGS10 Antibody	20 KD	Human, Mouse,Rat	WB IHC	200ug	59670
CLSDF4415	RGS12 Antibody	156 KD	Human, Mouse,Rat	WB	200ug	59670
CLSDF4416	RGS14 Antibody	65 KD	Human, Mouse,Rat	WB	200ug	59670
CLSDF4417	RGS5 Antibody	21 KD	Human, Mouse,Rat	WB IHC	200ug	59670
CLSDF4418	RGS7 Antibody	65 KD	Human, Mouse,Rat	WB	200ug	59670



Antibodies

HSN : 38220090

Cat#	Product Description	MW	Reactivity	Application	Pack Size	Unit Price
CLSDF4419	REN Antibody	40 KD	Human	WB	200ug	59670
CLSDF4420	RPTN Antibody	91 KD	Human	WB	200ug	59670
CLSDF4421	RFPL4A Antibody	42 KD	Human	WB	200ug	59670
CLSDF4422	ALDH1A2 Antibody	52 KD	Human, Mouse,Rat	WB	200ug	59670
CLSDF4423	RBBP5 Antibody	59 KD	Human, Mouse,Rat	WB	200ug	59670
CLSDF4424	ARHGDI8 Antibody	0 KD	Human	WB	200ug	59670
CLSDF4425	ARHGAP11A Antibody	110 KD	Human	WB	200ug	59670
CLSDF4426	RHG17 Antibody	100 KD	Human, Mouse,Rat	WB	200ug	59670
CLSDF4427	RHG18 Antibody	75 KD	Human	WB IHC	200ug	59670
CLSDF4428	RHG9 Antibody	90 KD	Human	WB	200ug	59670
CLSDF4429	ARHGEF1 Antibody	105 KD	Human, Mouse,Rat	WB	200ug	59670
CLSDF4430	ARHGEF10 Antibody	152 KD	Human	WB IHC	200ug	59670
CLSDF4431	ARHGEF11 Antibody	170 KD	Human, Mouse,Rat	WB	200ug	59670
CLSDF4432	ARHGEF12 Antibody	173 KD	Human, Mouse,Rat	WB	200ug	59670
CLSDF4433	ARHGEF16 Antibody	0 KD	Human	WB	200ug	59670
CLSDF4434	ARHGEF3 Antibody	55 KD	Human, Mouse,Rat	WB	200ug	59670
CLSDF4435	ARHGEF5 Antibody	60 KD	Human, Mouse,Rat	WB	200ug	59670
CLSDF4436	ARHGEF7 Antibody	75-80 KD	Human, Mouse,Rat	WB	200ug	59670
CLSDF4437	ARHGEF2 Antibody	101 KD	Human	WB	200ug	59670
CLSDF4438	RHOB Antibody	22 KD	Human, Mouse,Rat	WB	200ug	59670
CLSDF4439	RHOD Antibody	25 KD	Human	WB	200ug	59670
CLSDF4440	RPL7L1 Antibody	29 KD	Human	WB	200ug	59670
CLSDF4441	RIMKA Antibody	43 KD	Human, Mouse	WB	200ug	59670
CLSDF4442	RRS1 Antibody	41 KD	Human, Mouse,Rat	WB	200ug	59670
CLSDF4443	RFWD3 Antibody	85 KD	Human	WB	200ug	59670
CLSDF4444	RCL1 Antibody	41 KD	Human, Mouse,Rat	WB	200ug	59670
CLSDF4445	RPAP2 Antibody	70 KD	Human	WB	200ug	59670
CLSDF4446	RNUXA Antibody	48 KD	Human	WB	200ug	59670
CLSDF4447	EWSR1 Antibody	68 KD	Human, Mouse,Rat	WB	200ug	59670
CLSDF4448	RUFY1 Antibody	80 KD	Human, Mouse	WB	200ug	59670
CLSDF4449	ATP2A1 Antibody	100 KD	Human, Mouse,Rat	WB	200ug	59670
CLSDF4450	SCFD1 Antibody	75 KD	Human, Mouse,Rat	WB	200ug	59670
CLSDF4451	SFRP2 Antibody	30 KD	Human, Mouse,Rat	WB	200ug	59670
CLSDF4452	SERGEF Antibody	50 KD	Human	WB	200ug	59670
CLSDF4453	SCAMP1 Antibody	32 KD	Human, Mouse,Rat	WB	200ug	59670
CLSDF4454	DVL2 Antibody	0 KD	Human, Mouse	WB IHC	200ug	59670
CLSDF4455	DVL3 Antibody	78 KD	Human, Mouse	WB IHC	200ug	59670
CLSDF4456	SEMA7A Antibody	75 KD	Human, Mouse,Rat	WB	200ug	59670
CLSDF4457	SEPT14 Antibody	50 KD	Human	WB	200ug	59670
CLSDF4458	SEPT2 Antibody	41 KD	Human, Mouse,Rat	WB	200ug	59670
CLSDF4459	SEPT6 Antibody	50 KD	Human, Mouse,Rat	WB IHC	200ug	59670
CLSDF4460	SEPT7 Antibody	48 KD	Human, Mouse,Rat	WB	200ug	59670
CLSDF4461	PRSS33 Antibody	26 KD	Human	WB	200ug	59670
CLSDF4462	SPINK5 Antibody	121 KD	Human	WB	200ug	59670
CLSDF4463	STK24 Antibody	50 KD	Human, Mouse,Rat	WB IHC	200ug	59670
CLSDF4464	STK32C Antibody	55 KD	Human, Mouse	WB IHC	200ug	59670
CLSDF4465	STK36 Antibody	170 KD	Human, Mouse	WB IHC	200ug	59670
CLSDF4466	NEK5 Antibody	80 KD	Human, Mouse	WB	200ug	59670
CLSDF4467	NEK7 Antibody	35 KD	Human, Mouse	WB IHC	200ug	59670
CLSDF4468	NIM1 Antibody	50 KD	Human, Mouse	WB	200ug	59670
CLSDF4469	PDIK1L Antibody	39 KD	Human, Mouse	WB IHC	200ug	59670
CLSDF4470	PLK2 Antibody	78 KD	Human, Mouse,Rat	WB	200ug	59670
CLSDF4471	PLK3 Antibody	70 KD	Human, Mouse,Rat	WB	200ug	59670
CLSDF4472	PLK5 Antibody	55 KD	Human	WB	200ug	59670
CLSDF4473	PRKX Antibody	41 KD	Human, Mouse,Rat	WB IHC	200ug	59670
CLSDF4474	PRKY Antibody	34 KD	Human	WB	200ug	59670
CLSDF4475	SRPK1 Antibody	95 KD	Human, Mouse,Rat	WB	200ug	59670
CLSDF4476	TAOK1 Antibody	120 KD	Human, Mouse,Rat	WB IHC	200ug	59670
CLSDF4477	TNNI3K Antibody	0 KD	Human, Mouse,Rat	IHC	200ug	59670
CLSDF4478	TLK2 Antibody	90 KD	Human, Mouse	WB	200ug	59670
CLSDF4479	ULK3 Antibody	24 KD	Human, Mouse	WB IHC	200ug	59670
CLSDF4480	VRK2 Antibody	55 KD	Human, Mouse	WB	200ug	59670
CLSDF4481	PPP2R2B Antibody	51 KD	Human, Mouse,Rat	WB	200ug	59670
CLSDF4482	PPP2R5A Antibody	57 KD	Human, Mouse,Rat	WB	200ug	59670
CLSDF4483	PPP2R5D Antibody	70 KD	Human, Mouse,Rat	WB	200ug	59670
CLSDF4484	PPP2R1B Antibody	66 KD	Human, Mouse,Rat	WB IHC	200ug	59670
CLSDF4485	PPP2R3B Antibody	70 KD	Human	WB	200ug	59670
CLSDF4486	PPP2R3C Antibody	53 KD	Human, Mouse,Rat	WB	200ug	59670
CLSDF4487	PPP4R1L Antibody	50 KD	Human	WB	200ug	59670
CLSDF4488	PPP4R2 Antibody	50 KD	Human	WB	200ug	59670

Antibodies

HSN : 38220090

Cat#	Product Description	MW	Reactivity	Application	Pack Size	Unit Price
CLSDF4489	SERPINA11 Antibody	47 KD	Human	WB	200ug	59670
CLSDF4490	SERPINB12 Antibody	46 KD	Human	WB	200ug	59670
CLSDF4491	SERPINB4 Antibody	45 KD	Human	WB	200ug	59670
CLSDF4492	SERPINB7 Antibody	43 KD	Human	WB	200ug	59670
CLSDF4493	SERPINB9 Antibody	40 KD	Human, Mouse,Rat	WB IHC	200ug	59670
CLSDF4494	SESN1 Antibody	57 KD	Human, Mouse	WB IHC	200ug	59670
CLSDF4495	SHB Antibody	55 KD	Human, Mouse	WB	200ug	59670
CLSDF4496	SHD Antibody	130 KD	Human	WB	200ug	59670
CLSDF4497	SH2D2A Antibody	48 KD	Human	WB	200ug	59670
CLSDF4498	SH2D5 Antibody	35 KD	Human, Mouse,Rat	WB	200ug	59670
CLSDF4499	SH2B2 Antibody	0 KD	Human, Mouse,Rat	WB	200ug	59670
CLSDF4500	STAC2 Antibody	40 KD	Human, Mouse,Rat	WB	200ug	59670
CLSDF4501	SHANK2 Antibody	135 KD	Human	WB	200ug	59670
CLSDF4502	SH3TC1 Antibody	147 KD	Human	WB	200ug	59670
CLSDF4503	SH3GLB2 Antibody	48 KD	Human, Mouse,Rat	WB IHC	200ug	59670
CLSDF4504	SH3RF3 Antibody	0 KD	Human, Mouse	WB	200ug	59670
CLSDF4505	SH3GL2 Antibody	39 KD	Human, Mouse,Rat	WB	200ug	59670
CLSDF4506	SHC2 Antibody	59 KD	Human,Rat	WB	200ug	59670
CLSDF4507	SIRPB1 Antibody	48 KD	Human	WB	200ug	59670
CLSDF4508	SIRPG Antibody	42 KD	Human	WB	200ug	59670
CLSDF4509	SLC6A8 Antibody	71 KD	Human, Mouse,Rat	WB	200ug	59670
CLSDF4510	SLC6A1 Antibody	67 KD	Human, Mouse,Rat	WB	200ug	59670
CLSDF4511	SLC4A11 Antibody	100 KD	Human	WB	200ug	59670
CLSDF4512	SCN4B Antibody	27 KD	Human	WB	200ug	59670
CLSDF4513	SCN4A Antibody	208 KD	Human, Mouse,Rat	WB	200ug	59670
CLSDF4514	SCN2B Antibody	24 KD	Human, Mouse,Rat	WB	200ug	59670
CLSDF4515	SLC10A7 Antibody	39 KD	Human, Mouse,Rat	WB	200ug	59670
CLSDF4516	SLC5A2 Antibody	73 KD	Human, Mouse,Rat	WB	200ug	59670
CLSDF4517	SLC9A6 Antibody	74 KD	Human, Mouse	WB	200ug	59670
CLSDF4518	SLC9A7 Antibody	80 KD	Human, Mouse,Rat	WB	200ug	59670
CLSDF4519	SLC9A8 Antibody	65 KD	Human, Mouse,Rat	WB	200ug	59670
CLSDF4520	SLC9A9 Antibody	65 KD	Human, Mouse	WB	200ug	59670
CLSDF4521	SLC5A3 Antibody	80 KD	Human, Mouse,Rat	WB	200ug	59670
CLSDF4522	SLC28A2 Antibody	65 KD	Human,Rat	WB IHC	200ug	59670
CLSDF4523	SLC24A1 Antibody	121 KD	Human	WB	200ug	59670
CLSDF4524	SLC24A3 Antibody	61 KD	Human, Mouse,Rat	WB	200ug	59670
CLSDF4525	SLC24A4 Antibody	60 KD	Human, Mouse,Rat	WB	200ug	59670
CLSDF4526	SLC24A6 Antibody	60 KD	Human	WB	200ug	59670
CLSDF4527	ATP1A2 Antibody	112 KD	Human, Mouse,Rat	WB	200ug	59670
CLSDF4528	ATP1B3 Antibody	0 KD	Human	WB	200ug	59670
CLSDF4529	SLC6A3 Antibody	0 KD	Human, Mouse,Rat	0	200ug	59670
CLSDF4530	SLC5A6 Antibody	68 KD	Human	WB	200ug	59670
CLSDF4531	SLC17A2 Antibody	47 KD	Human, Mouse	WB	200ug	59670
CLSDF4532	SLC4A8/10 Antibody	140 KD	Human, Mouse,Rat	WB	200ug	59670
CLSDF4533	SLCO1A2 Antibody	80 KD	Human	WB	200ug	59670
CLSDF4534	SLCO1B1 Antibody	76 KD	Human	WB	200ug	59670
CLSDF4535	SOS2 Antibody	153 KD	Human	WB	200ug	59670
CLSDF4536	SNX1 Antibody	0 KD	Human, Mouse,Rat	WB	200ug	59670
CLSDF4537	SNX3 Antibody	18 KD	Human, Mouse,Rat	WB	200ug	59670
CLSDF4538	SNX4 Antibody	60 KD	Human, Mouse,Rat	WB	200ug	59670
CLSDF4539	SF3B3 Antibody	136 KD	Human, Mouse	WB	200ug	59670
CLSDF4540	SF3B4 Antibody	55 KD	Human, Mouse,Rat	WB IHC	200ug	59670
CLSDF4541	SFRS11 Antibody	54 KD	Human, Mouse	WB	200ug	59670
CLSDF4542	SFRS15 Antibody	140 KD	Human, Mouse,Rat	WB	200ug	59670
CLSDF4543	SFRS2B Antibody	32 KD	Human	WB	200ug	59670
CLSDF4544	SFRS7 Antibody	35 KD	Human, Mouse	WB	200ug	59670
CLSDF4545	SFRS8 Antibody	105 KD	Human	WB	200ug	59670
CLSDF4546	STMN3 Antibody	21 KD	Human, Mouse,Rat	WB	200ug	59670
CLSDF4547	STMN4 Antibody	22 KD	Human, Mouse,Rat	WB	200ug	59670
CLSDF4548	STK39 Antibody	60 KD	Human, Mouse,Rat	WB	200ug	59670
CLSDF4549	ZNF280C Antibody	85 KD	Human	WB	200ug	59670
CLSDF4550	UBASH3A Antibody	74 KD	Human	WB	200ug	59670
CLSDF4551	SVOP Antibody	61 KD	Human, Mouse,Rat	WB	200ug	59670
CLSDF4552	SYT11 Antibody	48 KD	Human, Mouse,Rat	WB	200ug	59670
CLSDF4553	SYT13 Antibody	48 KD	Human, Mouse,Rat	WB	200ug	59670
CLSDF4554	SYT16 Antibody	72 KD	Human	WB	200ug	59670
CLSDF4555	SYTL4 Antibody	76 KD	Human, Mouse,Rat	WB	200ug	59670
CLSDF4556	TBX18 Antibody	68 KD	Human, Mouse,Rat	WB	200ug	59670
CLSDF4557	CD6 Antibody	73 KD	Human	WB	200ug	59670
CLSDF4558	CD1E Antibody	36 KD	Human	WB	200ug	59670



Antibodies

HSN : 38220090

Cat#	Product Description	MW	Reactivity	Application	Pack Size	Unit Price
CLSDF4559	CCT5 Antibody	67 KD	Human, Mouse,Rat	WB	200ug	59670
CLSDF4560	CCT7 Antibody	59 KD	Human, Mouse,Rat	WB	200ug	59670
CLSDF4561	CCT8 Antibody	59 KD	Human, Mouse	WB	200ug	59670
CLSDF4562	CCT6A Antibody	60 KD	Human, Mouse,Rat	WB IHC	200ug	59670
CLSDF4563	TSSK4 Antibody	40 KD	Human, Mouse	WB	200ug	59670
CLSDF4564	THAP4 Antibody	63 KD	Human, Mouse,Rat	WB	200ug	59670
CLSDF4565	THBD Antibody	60 KD	Human	WB	200ug	59670
CLSDF4566	TIGD1 Antibody	67 KD	Human	WB	200ug	59670
CLSDF4567	TIGD3 Antibody	55 KD	Human	WB IHC	200ug	59670
CLSDF4568	TOR1AIP1 Antibody	66 KD	Human	WB	200ug	59670
CLSDF4569	TRAPP3 Antibody	22 KD	Human, Mouse,Rat	WB	200ug	59670
CLSDF4570	TCEAL1 Antibody	20 KD	Human, Mouse,Rat	WB	200ug	59670
CLSDF4571	TCEAL6 Antibody	25 KD	Human	WB	200ug	59670
CLSDF4572	TCF4/12 Antibody	60 KD	Human, Mouse,Rat	WB	200ug	59670
CLSDF4573	TCF7L1 Antibody	63 KD	Human, Mouse	WB	200ug	59670
CLSDF4574	GTF3A Antibody	0 KD	Human	WB	200ug	59670
CLSDF4575	TAF3 Antibody	100 KD	Human, Mouse,Rat	WB	200ug	59670
CLSDF4576	MTERF Antibody	46 KD	Human	WB IHC	200ug	59670
CLSDF4577	EIF2B4 Antibody	57 KD	Human, Mouse,Rat	WB	200ug	59670
CLSDF4578	EIF2B3 Antibody	0 KD	Human, Mouse	WB	200ug	59670
CLSDF4579	MTIF3 Antibody	30 KD	Human	WB	200ug	59670
CLSDF4580	TMBIM1 Antibody	35 KD	Human, Mouse,Rat	WB	200ug	59670
CLSDF4581	TSEN54 Antibody	59 KD	Human	WB IHC	200ug	59670
CLSDF4582	TIE1 Antibody	130 KD	Human, Mouse,Rat	WB	200ug	59670
CLSDF4583	SGK269 Antibody	193 KD	Human	WB	200ug	59670
CLSDF4584	PTPN22 Antibody	0 KD	Human, Mouse,Rat	WB	200ug	59670
CLSDF4585	UBQLN3 Antibody	0 KD	Human, Mouse,Rat	WB IHC	200ug	59670
CLSDF4586	USP11 Antibody	0 KD	Human, Mouse,Rat	WB	200ug	59670
CLSDF4587	USP13 Antibody	97 KD	Human, Mouse	WB IHC	200ug	59670
CLSDF4588	USP15 Antibody	115 KD	Human, Mouse,Rat	WB	200ug	59670
CLSDF4589	USP19 Antibody	130 KD	Human, Mouse,Rat	WB IHC	200ug	59670
CLSDF4590	USP30 Antibody	60 KD	Human, Mouse,Rat	WB	200ug	59670
CLSDF4591	USP38 Antibody	117 KD	Human	WB	200ug	59670
CLSDF4592	USP42 Antibody	150 KD	Human, Mouse,Rat	WB	200ug	59670
CLSDF4593	USP43 Antibody	125 KD	Human, Mouse	WB	200ug	59670
CLSDF4594	USP44 Antibody	81 KD	Human	WB	200ug	59670
CLSDF4595	USP45 Antibody	90 KD	Human, Mouse,Rat	WB	200ug	59670
CLSDF4596	UBFD1 Antibody	50 KD	Human, Mouse,Rat	WB	200ug	59670
CLSDF4597	YOD1 Antibody	35 KD	Human	WB	200ug	59670
CLSDF4598	UBAC1 Antibody	45 KD	Human	WB	200ug	59670
CLSDF4599	UBAP2L Antibody	115 KD	Human, Mouse	WB	200ug	59670
CLSDF4600	UBE2D2 Antibody	17 KD	Human, Mouse,Rat	WB	200ug	59670
CLSDF4601	UBE2T Antibody	22 KD	Human, Mouse	WB	200ug	59670
CLSDF4602	UEVLD Antibody	52 KD	Human	WB IHC	200ug	59670
CLSDF4603	UGDH Antibody	55 KD	Human, Mouse,Rat	WB	200ug	59670
CLSDF4604	ATP6V1B1 Antibody	60 KD	Human, Mouse	WB IHC	200ug	59670
CLSDF4605	ATP6V1C2 Antibody	49 KD	Human	WB	200ug	59670
CLSDF4606	VPS26B Antibody	45 KD	Human, Mouse	WB	200ug	59670
CLSDF4607	VANGL1 Antibody	50 KD	Human, Mouse	WB	200ug	59670
CLSDF4608	SFT2B Antibody	18 KD	Human, Mouse,Rat	WB	200ug	59670
CLSDF4609	VT11A Antibody	23 KD	Human, Mouse,Rat	WB	200ug	59670
CLSDF4610	VT11B Antibody	0 KD	Human, Mouse,Rat	WB	200ug	59670
CLSDF4611	NSF Antibody	75 KD	Human, Mouse,Rat	WB	200ug	59670
CLSDF4612	CACNG1 Antibody	25 KD	Human, Mouse,Rat	WB	200ug	59670
CLSDF4613	CACNG7 Antibody	40 KD	Human, Mouse,Rat	WB	200ug	59670
CLSDF4614	CACNA2D4 Antibody	128 KD	Human, Mouse,Rat	WB	200ug	59670
CLSDF4615	CACNA1H Antibody	259 KD	Human, Mouse,Rat	WB	200ug	59670
CLSDF4616	WIPF1 Antibody	52 KD	Human, Mouse,Rat	WB	200ug	59670
CLSDF4617	WEE2 Antibody	60 KD	Human	WB	200ug	59670
CLSDF4618	WASF2 Antibody	54 KD	Human, Mouse,Rat	WB IHC	200ug	59670
CLSDF4619	WASF3 Antibody	55 KD	Human, Mouse	WB IHC	200ug	59670
CLSDF4620	ZBTB40 Antibody	138 KD	Human, Mouse	WB IHC	200ug	59670
CLSDF4621	ZSCAN22 Antibody	55 KD	Human	WB IHC	200ug	59670
CLSDF4622	ZC3H11A Antibody	85 KD	Human	WB	200ug	59670
CLSDF4623	ZC3H13 Antibody	200 KD	Human, Mouse	WB	200ug	59670
CLSDF4624	ZC3H8 Antibody	40 KD	Human	WB IHC	200ug	59670
CLSDF4625	ZFYVE19 Antibody	50 KD	Human	WB IHC	200ug	59670
CLSDF4626	ZNF292 Antibody	300 KD	Human	WB	200ug	59670
CLSDF4627	ZNF420 Antibody	80 KD	Human, Mouse	WB	200ug	59670
CLSDF4628	ZNF460 Antibody	64 KD	Human	WB	200ug	59670



Antibodies

HSN : 38220090

Cat#	Product Description	MW	Reactivity	Application	Pack Size	Unit Price
CLSDF4629	ZNF592 Antibody	160 KD	Human, Mouse	WB IHC	200ug	59670
CLSDF4630	ZNF771 Antibody	34 KD	Human, Mouse	WB	200ug	59670
CLSDF4631	ZZZ3 Antibody	102 KD	Human, Mouse,Rat	WB	200ug	59670
CLSDF4632	SLC30A1 Antibody	55 KD	Human	WB	200ug	59670
CLSDF4633	SLC30A4 Antibody	47 KD	Human, Mouse,Rat	WB IHC	200ug	59670
CLSDF4634	SLC30A9 Antibody	63 KD	Human, Mouse,Rat	WB	200ug	59670
CLSDF4635	SLC39A7 Antibody	50 KD	Human, Mouse,Rat	WB	200ug	59670
CLSDF4636	SLC39A9 Antibody	33 KD	Human,Rat	WB	200ug	59670
CLSDF4637	SLC39A1 Antibody	38 KD	Human	WB	200ug	59670
CLSDF4638	SLC39A4 Antibody	68 KD	Human	WB	200ug	59670
CLSDF4639	ZADH1 Antibody	35 KD	Human	WB	200ug	59670
CLSDF4640	ZADH2 Antibody	45 KD	Human, Mouse,Rat	WB	200ug	59670
CLSDF4641	ZP1 Antibody	70 KD	Human	WB	200ug	59670
CLSDF4642	ZP4 Antibody	65 KD	Human	WB	200ug	59670
CLSDF4643	CA181 Antibody	54 KD	Human, Mouse	WB	200ug	59670
CLSDF4644	RAD51L2 Antibody	50 KD	Human	WB	200ug	59670
CLSDF4645	RAD23B Antibody	58 50 KD	Human, Mouse,Rat	WB	200ug	59670
CLSDF4646	TACC3 Antibody	80 KD	Human, Mouse	WB IHC IF/ICC	200ug	59670
CLSDF4647	ZNF498 Antibody	30 KD	Human	WB	200ug	59670
CLSDF4648	TBX3 Antibody	79 KD	Human, Mouse,Rat	WB	200ug	59670
CLSDF4649	ADCY9 Antibody	150 KD	Human	WB IHC	200ug	59670
CLSDF4650	IGFALS Antibody	66 KD	Human	WB	200ug	59670
CLSDF4651	ZNF498 Antibody	55 KD	Human	WB	200ug	59670
CLSDF4652	PSMD6 Antibody	45 KD	Human, Mouse,Rat	WB	200ug	59670
CLSDF4653	TAZ Antibody	0 KD	Human	WB	200ug	59670
CLSDF4654	RNF130 Antibody	36 KD	Human, Mouse,Rat	WB	200ug	59670
CLSDF4655	SMUG1 Antibody	32 KD	Human, Mouse,Rat	WB	200ug	59670
CLSDF4656	IKZF2 Antibody	56 KD	Human, Mouse,Rat	WB	200ug	59670
CLSDF4657	RALY Antibody	35 KD	Human, Mouse,Rat	WB	200ug	59670
CLSDF4658	A20A1 Antibody	95 KD	Human	WB	200ug	59670
CLSDF4659	ZNF691 Antibody	0 KD	Human	WB	200ug	59670
CLSDF4660	MED27 Antibody	35 KD	Human, Mouse	WB	200ug	59670
CLSDF4661	TBPL2 Antibody	41 KD	Human	WB IHC	200ug	59670
CLSDF4662	CREB3L2 Antibody	58 KD	Human, Mouse,Rat	WB	200ug	59670
CLSDF4663	ZNF329 Antibody	61 KD	Human	WB	200ug	59670
CLSDF4664	THOC4 Antibody	27 KD	Human, Mouse,Rat	WB	200ug	59670
CLSDF4665	LIPB1 Antibody	115 KD	Human, Mouse	WB	200ug	59670
CLSDF4666	ZNF575 Antibody	26 KD	Human	WB	200ug	59670
CLSDF4667	NKX28 Antibody	26 KD	Human	WB	200ug	59670
CLSDF4668	ZNF695 Antibody	0 KD	Human	WB	200ug	59670
CLSDF4669	RNF113B Antibody	0 KD	Human	WB	200ug	59670
CLSDF4670	OSR2 Antibody	0 KD	Human, Mouse,Rat	WB	200ug	59670
CLSDF4671	EME1 Antibody	65 KD	Human	WB	200ug	59670
CLSDF4672	IKZF4 Antibody	64 KD	Human, Mouse,Rat	WB	200ug	59670
CLSDF4673	SLC38A2 Antibody	50 KD	Human	WB	200ug	59670
CLSDF4674	ARX Antibody	55 KD	Human, Mouse,Rat	WB	200ug	59670
CLSDF4675	FEV Antibody	0 KD	Human	WB	200ug	59670
CLSDF4676	MNT Antibody	62 KD	Human	WB	200ug	59670
CLSDF4677	TEAD3 Antibody	49 KD	Human, Mouse	WB	200ug	59670
CLSDF4678	ELF4 Antibody	70 KD	Human, Mouse	WB	200ug	59670
CLSDF4679	CDX2 Antibody	36 KD	Human, Mouse,Rat	WB	200ug	59670
CLSDF4680	NPAS1 Antibody	62 KD	Human	WB	200ug	59670
CLSDF4681	NDFIP1 Antibody	0 KD	Human, Mouse,Rat	WB	200ug	59670
CLSDF4682	SPON2 Antibody	37 KD	Human, Mouse,Rat	WB	200ug	59670
CLSDF4683	TAOK3 Antibody	110 KD	Human, Mouse,Rat	WB	200ug	59670
CLSDF4684	SIRT3 Antibody	45 KD	Human	WB	200ug	59670
CLSDF4685	ZNF446 Antibody	49 KD	Human	WB	200ug	59670
CLSDF4686	BRE Antibody	47 KD	Human, Mouse,Rat	WB	200ug	59670
CLSDF4687	KITH_HHV1 Antibody	40 KD	Human	WB	200ug	59670
CLSDF4688	ZDHH2 Antibody	42 KD	Human, Mouse,Rat	WB	200ug	59670
CLSDF4689	PLAGL1 Antibody	50 KD	Human	WB	200ug	59670
CLSDF4690	GENE Antibody	80 KD	Human, Mouse,Rat	WB IHC	200ug	59670
CLSDF4691	STARD10 Antibody	0 KD	Human, Mouse,Rat	WB	200ug	59670
CLSDF4692	SLC30A9 Antibody	60 KD	Human, Mouse,Rat	WB	200ug	59670
CLSDF4693	DGKB Antibody	90 KD	Human, Mouse,Rat	WB	200ug	59670
CLSDF4694	DUSP10 Antibody	0 KD	Human, Mouse,Rat	WB	200ug	59670
CLSDF4695	Cytochrome P450 11B1/2 Antibody	0 KD	Human	WB	200ug	59670
CLSDF4696	CD70 Antibody	30 KD	Human	WB	200ug	59670
CLSDF4697	Cytochrome P450 11A1 Antibody	60 KD	Human	WB	200ug	59670

Antibodies
HSN : 38220090

Cat#	Product Description	MW	Reactivity	Application	Pack Size	Unit Price
CLSDF4698	CYC1 Antibody	35 KD	Human, Mouse	WB	200ug	59670
CLSDF4699	FGF13 Antibody	28 KD	Human, Mouse,Rat	WB	200ug	59670
CLSDF4700	FGFP2 Antibody	37 KD	Human	WB	200ug	59670
CLSDF4701	FGRL1 Antibody	0 KD	Human, Mouse	WB	200ug	59670
CLSDF4702	GAB2 Antibody	0 KD	Human, Mouse,Rat	WB	200ug	59670
CLSDF4703	HBAP1 Antibody	55 KD	Human	WB	200ug	59670
CLSDF4704	HSPA8 Antibody	72 KD	Human, Mouse,Rat	WB	200ug	59670
CLSDF4705	IL11RA Antibody	0 KD	Human	WB	200ug	59670
CLSDF4706	IL13RA2 Antibody	50 KD	Human	WB	200ug	59670
CLSDF4707	IL15RA Antibody	32 KD	Human,Rat	WB	200ug	59670
CLSDF4708	IL17RC Antibody	70 KD	Human	WB	200ug	59670
CLSDF4709	IL18BP Antibody	44 KD	Human	WB	200ug	59670
CLSDF4710	IGF2BP2 Antibody	65 KD	Human	WB	200ug	59670
CLSDF4711	IFIT5 Antibody	50 KD	Human	WB	200ug	59670
CLSDF4712	IL18R Antibody	65 KD	Human	WB	200ug	59670
CLSDF4713	IL4 Antibody	0 KD	Human	WB	200ug	59670
CLSDF4714	KRT37/38 Antibody	50 KD	Human	WB	200ug	59670
CLSDF4715	MOX2R Antibody	37 KD	Human	WB	200ug	59670
CLSDF4716	MX2 Antibody	0 KD	Human	WB	200ug	59670
CLSDF4717	MYL3 Antibody	22 KD	Human	WB	200ug	59670
CLSDF4718	MYL6 Antibody	0 KD	Human, Mouse,Rat	WB	200ug	59670
CLSDF4719	MYLK Antibody	200 KD	Human, Mouse,Rat	WB	200ug	59670
CLSDF4720	PLA2G6 Antibody	0 KD	Human, Mouse,Rat	WB	200ug	59670
CLSDF4721	PLCB2 Antibody	0 KD	Human, Mouse,Rat	WB	200ug	59670
CLSDF4722	ALPL Antibody	57 KD	Human, Mouse,Rat	WB	200ug	59670
CLSDF4723	SNIP Antibody	112 KD	Human, Mouse,Rat	WB	200ug	59670
CLSDF4724	SUV39H2 Antibody	46 KD	Human, Mouse	WB	200ug	59670
CLSDF4725	TAIP-12 Antibody	60 KD	Human, Mouse,Rat	WB	200ug	59670
CLSDF4726	TAIP-2 Antibody	64 KD	Human, Mouse	WB	200ug	59670
CLSDF4727	TUBA3C/E Antibody	50 KD	Human, Mouse,Rat	WB	200ug	59670
CLSDF4728	TRAF4 Antibody	53 KD	Human, Mouse,Rat	WB	200ug	59670
CLSDF4729	ZAR1 Antibody	0 KD	Human	WB	200ug	59670
CLSDF4730	MYL7 Antibody	18 KD	Human, Mouse,Rat	WB	200ug	59670
CLSDF4731	ANAPC5 Antibody	85 KD	Human	WB	200ug	59670
CLSDF4732	CDC14A Antibody	0 KD	Human	WB	200ug	59670
CLSDF4733	CHFR Antibody	0 KD	Human, Mouse,Rat	WB	200ug	59670
CLSDF4734	CNNM2 Antibody	100 KD	Human, Mouse,Rat	WB	200ug	59670
CLSDF4735	RFC2 Antibody	39 KD	Human, Mouse,Rat	WB	200ug	59670
CLSDF4736	GATA6 Antibody	45 KD	Human, Mouse,Rat	WB	200ug	59670
CLSDF4737	BCL7A Antibody	22 KD	Human, Mouse	WB	200ug	59670
CLSDF4738	NFE2L3 Antibody	75 KD	Human	WB	200ug	59670
CLSDF4739	NRF1 Antibody	53 KD	Human, Mouse,Rat	WB	200ug	59670
CLSDF4740	TMEM101 Antibody	29 KD	Human, Mouse	WB	200ug	59670
CLSDF4741	TOP1 Antibody	0 KD	Human, Mouse,Rat	WB	200ug	59670
CLSDF4742	Cytochrome P450 1B1 Antibody	0 KD	Human	WB	200ug	59670
CLSDF4743	Cytochrome P450 26C1 Antibody	0 KD	Human, Mouse,Rat	WB	200ug	59670
CLSDF4744	Cytochrome P450 4V2 Antibody	0 KD	Human	WB IHC	200ug	59670
CLSDF4745	PTGIS Antibody	0 KD	Human, Mouse,Rat	WB	200ug	59670
CLSDF4746	TBXAS1 Antibody	0 KD	Human	WB	200ug	59670
CLSDF4747	Cytochrome P450 2D6 Antibody	0 KD	Human	WB IHC	200ug	59670
CLSDF4748	Cytochrome P450 3A7 Antibody	50 KD	Human	WB	200ug	59670
CLSDF4749	Cytochrome P450 4A11/22 Antibody	60 KD	Human	WB	200ug	59670
CLSDF4750	Cytochrome P450 4F11 Antibody	60 KD	Human	WB	200ug	59670
CLSDF4751	Cytochrome P450 4X1 Antibody	60 KD	Human	WB	200ug	59670
CLSDF4752	Cytochrome P450 21 Antibody	0 KD	Human	WB	200ug	59670
CLSDF4753	Cytochrome P450 C21 Antibody	0 KD	Human	WB IHC	200ug	59670
CLSDF4754	Cytochrome P450 2A6V2 Antibody	0 KD	Human	WB IHC	200ug	59670
CLSDF4755	Cytochrome P450 2A7	0 KD	Human	WB IHC	200ug	59670
CLSDF4756	Cytochrome P450 2D6 Antibody	0 KD	Human	WB	200ug	59670
CLSDF4757	Cytochrome P450 2D6 Antibody	55 KD	Human	WB IHC	200ug	59670
CLSDF4758	Cytochrome P450 2D6 Antibody	0 KD	Human	WB	200ug	59670
CLSDF4759	Cytochrome P450 2B6 Antibody	0 KD	Human	WB	200ug	59670
CLSDF4760	Cytochrome P450 20A1 Antibody	53 KD	Human	WB	200ug	59670
CLSDF4761	Cytochrome P450 39A1 Antibody	0 KD	Human	WB IHC	200ug	59670
CLSDF4762	Cytochrome P450 8B1 Antibody	58 KD	Human, Mouse	WB IHC	200ug	59670
CLSDF4763	SIRT2 Antibody	43 KD	Human, Mouse,Rat	WB	200ug	59670
CLSDF4764	PIK3CG Antibody	120 KD	Human	WB IHC	200ug	59670
CLSDF4765	KCNJ4 Antibody	50 KD	Human, Mouse,Rat	WB	200ug	59670
CLSDF4766	MRIP Antibody	0 KD	Human, Mouse,Rat	WB	200ug	59670
CLSDF4767	TRAF2 Antibody	0 KD	Human	WB IHC	200ug	59670



Antibodies

HSN : 38220090

Cat#	Product Description	MW	Reactivity	Application	Pack Size	Unit Price
CLSDF4768	BAG3 Antibody	62 KD	Human, Mouse,Rat	WB IHC	200ug	59670
CLSDF4769	BAG4 Antibody	0 KD	Human, Mouse,Rat	WB IHC	200ug	59670
CLSDF4770	TBX3 Antibody	79 KD	Human, Mouse,Rat	WB	200ug	59670
CLSDF4771	POU4F1 Antibody	42 KD	Human, Mouse,Rat	WB	200ug	59670
CLSDF4772	MAGEC2 Antibody	41 KD	Human	WB	200ug	59670
CLSDF4773	BUB1 Antibody	120 KD	Human	WB	200ug	59670
CLSDF4774	CSNK1D Antibody	47 KD	Human, Mouse,Rat	WB	200ug	59670
CLSDF4775	MATK Antibody	0 KD	Human, Mouse,Rat	WB IHC	200ug	59670
CLSDF4776	DDR1 Antibody	100 KD	Human	WB	200ug	59670
CLSDF4777	STK17B Antibody	45 KD	Human, Mouse,Rat	WB IHC	200ug	59670
CLSDF4778	EPHA2 Antibody	105 KD	Human, Mouse	WB	200ug	59670
CLSDF4779	EPHA5 Antibody	110 KD	Human, Mouse,Rat	WB	200ug	59670
CLSDF4780	EPHB1 Antibody	120 KD	Human, Mouse,Rat	WB	200ug	59670
CLSDF4781	HUNK Antibody	75 KD	Human, Mouse,Rat	WB	200ug	59670
CLSDF4782	IRAK2 Antibody	0 KD	Human	WB	200ug	59670
CLSDF4783	STK10 Antibody	120 KD	Human	WB	200ug	59670
CLSDF4784	MASTL Antibody	0 KD	Human	WB	200ug	59670
CLSDF4785	MERTK Antibody	110 KD	Human	WB	200ug	59670
CLSDF4786	CDC42BPA Antibody	0 KD	Human, Mouse,Rat	WB	200ug	59670
CLSDF4787	PAK7 Antibody	80 KD	Human, Mouse,Rat	WB IHC	200ug	59670
CLSDF4788	PHKG1 Antibody	45 KD	Human	WB	200ug	59670
CLSDF4789	PRKCG Antibody	75 KD	Human, Mouse,Rat	WB	200ug	59670
CLSDF4790	PKN1 Antibody	0 KD	Human, Mouse,Rat	WB	200ug	59670
CLSDF4791	STK33 Antibody	0 KD	Human	WB IHC	200ug	59670
CLSDF4792	TLK1 Antibody	87 KD	Human	WB	200ug	59670
CLSDF4793	CAMKK2 Antibody	65 KD	Human, Mouse,Rat	WB IHC	200ug	59670
CLSDF4794	MKNK2 Antibody	0 KD	Human, Mouse,Rat	WB	200ug	59670
CLSDF4795	TESK2 Antibody	65 KD	Human, Mouse,Rat	WB	200ug	59670
CLSDF4796	VRK3 Antibody	0 KD	Human	WB	200ug	59670
CLSDF4797	APOE Antibody	0 KD	Human	WB	200ug	59670
CLSDF4798	LRP8 Antibody	100 KD	Human	WB	200ug	59670
CLSDF4799	ACTBL2 Antibody	40 KD	Human, Mouse	WB	200ug	59670
CLSDF4800	ERI1 Antibody	40 KD	Human, Mouse,Rat	WB	200ug	59670
CLSDF4801	FCGR2A Antibody	35 KD	Human	WB	200ug	59670
CLSDF4802	FCGR2C Antibody	35 KD	Human	WB	200ug	59670
CLSDF4803	CD79A Antibody	25 KD	Human	WB	200ug	59670
CLSDF4804	THY1 Antibody	28 KD	Human	WB	200ug	59670
CLSDF4805	SLC44A1 Antibody	73 KD	Human, Mouse,Rat	WB	200ug	59670
CLSDF4806	LAMP1 Antibody	125 KD	Human	WB	200ug	59670
CLSDF4807	SDC1 Antibody	32 KD	Human,Rat	WB	200ug	59670
CLSDF4808	KLRC1 Antibody	28 KD	Human	WB	200ug	59670
CLSDF4809	HMMR Antibody	85 KD	Human	WB IHC	200ug	59670
CLSDF4810	LY75 Antibody	0 KD	Human	WB	200ug	59670
CLSDF4811	TNFRSF10D Antibody	42 KD	Human	WB	200ug	59670
CLSDF4812	BTLA Antibody	0 KD	Human	WB	200ug	59670
CLSDF4813	CLM-1 Antibody	30 KD	Human	WB	200ug	59670
CLSDF4814	CD300LG Antibody	0 KD	Human	0	200ug	59670
CLSDF4815	FCRL5 Antibody	107 KD	Human	WB	200ug	59670
CLSDF4816	KLRK1 Antibody	25 KD	Human	WB	200ug	59670
CLSDF4817	ATG16L2 Antibody	69 KD	Human	WB	200ug	59670
CLSDF4818	IL21 Antibody	18 KD	Human, Mouse	WB	200ug	59670
CLSDF4819	IL41 Antibody	0 KD	Human	WB	200ug	59670
CLSDF4820	CSF2RA Antibody	0 KD	Human	WB	200ug	59670
CLSDF4821	DSG1 Antibody	114 KD	Human, Mouse	WB	200ug	59670
CLSDF4822	VASH1 Antibody	40 KD	Human, Mouse,Rat	WB	200ug	59670
CLSDF4823	LHX1 Antibody	0 KD	Human, Mouse,Rat	WB IHC	200ug	59670
CLSDF4824	CTSD Antibody	0 KD	Human, Mouse	WB IHC	200ug	59670
CLSDF4825	PA2G4 Antibody	44 KD	Human, Mouse	WB	200ug	59670
CLSDF4826	RRM2B Antibody	0 KD	Human, Mouse,Rat	WB	200ug	59670
CLSDF4827	NR112 Antibody	50 KD	Human	WB	200ug	59670
CLSDF4828	FTH1 Antibody	0 KD	Human, Mouse,Rat	WB	200ug	59670
CLSDF4829	Carboxypeptidase A1 Antibody	47 KD	Human	WB IHC	200ug	59670
CLSDF4830	FGB Antibody	0 KD	Human	WB	200ug	59670
CLSDF4831	MC1PH1 Antibody	93 KD	Human, Mouse	WB IHC	200ug	59670
CLSDF4832	FAM3D Antibody	0 KD	Human	WB IHC	200ug	59670
CLSDF4833	INA Antibody	0 KD	Human, Mouse,Rat	WB	200ug	59670
CLSDF4834	GPC5 Antibody	0 KD	Human, Mouse,Rat	WB	200ug	59670
CLSDF4835	RUNX3 Antibody	0 KD	Human	WB	200ug	59670
CLSDF4836	TOLLIP Antibody	0 KD	Human	WB IHC	200ug	59670
CLSDF4837	PLG Antibody	0 KD	Human	WB	200ug	59670

Antibodies

HSN : 38220090

Cat#	Product Description	MW	Reactivity	Application	Pack Size	Unit Price
CLSDF4838	MAD2L1 Antibody	25 KD	Human	WB	200ug	59670
CLSDF4839	FST Antibody	65 KD	Human, Mouse,Rat	WB	200ug	59670
CLSDF4840	LBP Antibody	53 KD	Human, Mouse,Rat	WB	200ug	59670
CLSDF4841	0	0 KD	Human, Mouse,Rat	0	200ug	59670
CLSDF4842	Histone H4 (Acetyl-Lys5) Antibody	11 KD	Human:K5, Mouse:K5,Rat:K5	WB IHC IF/ICC	200ug	59670
CLSDF4843	Histone H4 (Ab-5) Antibody	11 KD	Human, Mouse,Rat	WB IHC IF/ICC	200ug	59670
CLSDF4844	HTR1B Antibody	48 KD	Human, Mouse,Rat	WB IF/ICC	200ug	59670
CLSDF4845	HTR2B Antibody	54 KD	Human	WB IF/ICC	200ug	59670
CLSDF4846	HTR2C Antibody	51 KD	Human, Mouse,Rat	WB	200ug	59670
CLSDF4847	HTR4 Antibody	43 KD	Human,Rat	WB IF/ICC	200ug	59670
CLSDF4848	HTR5A Antibody	36 KD	Human	WB IF/ICC	200ug	59670
CLSDF4849	HTR5B Antibody	38 KD	Mouse,Rat	WB IF/ICC	200ug	59670
CLSDF4850	ADORA2A Antibody	37 KD	Human	WB IHC IF/ICC	200ug	59670
CLSDF4851	ADORA3 Antibody	38 KD	Human	WB IF/ICC	200ug	59670
CLSDF4852	ADRA1A Antibody	51 KD	Human, Mouse,Rat	WB IF/ICC	200ug	59670
CLSDF4853	AGTRL1 Antibody	43 KD	Human	WB IF/ICC	200ug	59670
CLSDF4854	ADRB2 Antibody	48 KD	Human	WB IF/ICC	200ug	59670
CLSDF4855	BRS3 Antibody	44 KD	Human	WB IF/ICC	200ug	59670
CLSDF4856	CCR7 Antibody	43 KD	Human	WB IF/ICC	200ug	59670
CLSDF4857	CCR11 Antibody	40 KD	Human, Mouse	WB IF/ICC	200ug	59670
CLSDF4858	CXCR3 Antibody	40 KD	Human	WB	200ug	59670
CLSDF4859	CXCR7 Antibody	41 KD	Human, Mouse,Rat	WB IF/ICC	200ug	59670
CLSDF4860	CCBP2 Antibody	34 KD	Human	WB IF/ICC	200ug	59670
CLSDF4861	CCKBR Antibody	48 KD	Human, Mouse,Rat	WB	200ug	59670
CLSDF4862	CLPT1 Antibody	74 KD	Human, Mouse	WB	200ug	59670
CLSDF4863	CRHR1 Antibody	50 KD	Human, Mouse,Rat	WB IF/ICC	200ug	59670
CLSDF4864	CRHR2 Antibody	48 KD	Human, Mouse,Rat	WB IF/ICC	200ug	59670
CLSDF4865	CYSLTR1 Antibody	38 KD	Human	WB IF/ICC	200ug	59670
CLSDF4866	DRD4 Antibody	48 KD	Human, Mouse,Rat	WB IF/ICC	200ug	59670
CLSDF4867	EDG1 Antibody	43 KD	Human	WB IF/ICC	200ug	59670
CLSDF4868	EDG2 Antibody	38 KD	Human,Rat	WB IHC IF/ICC	200ug	59670
CLSDF4869	EDG3 Antibody	40 KD	Human	WB IF/ICC	200ug	59670
CLSDF4870	EDG4 Antibody	39 KD	Human	WB IF/ICC	200ug	59670
CLSDF4871	EDG5 Antibody	39 KD	Human, Mouse,Rat	WB	200ug	59670
CLSDF4872	EDG6 Antibody	40 KD	Human, Mouse	WB IF/ICC	200ug	59670
CLSDF4873	EDG7 Antibody	40 KD	Human, Mouse,Rat	WB IF/ICC	200ug	59670
CLSDF4874	EMR1 Antibody	98 KD	Human	WB	200ug	59670
CLSDF4875	EMR2 Antibody	85 KD	Human	WB IF/ICC	200ug	59670
CLSDF4876	EMR3 Antibody	70 KD	Human	WB	200ug	59670
CLSDF4877	OPN3 Antibody	45 KD	Human, Mouse	WB IF/ICC	200ug	59670
CLSDF4878	PE2R2 Antibody	40 KD	Human, Mouse,Rat	WB	200ug	59670
CLSDF4879	PE2R3 Antibody	40 KD	Human	WB IHC IF/ICC	200ug	59670
CLSDF4880	PE2R4 Antibody	55 KD	Human	WB IF/ICC	200ug	59670
CLSDF4881	FPR1 Antibody	40 KD	Human	WB IF/ICC	200ug	59670
CLSDF4882	FZD1 Antibody	71 KD	Human	WB	200ug	59670
CLSDF4883	FZD10 Antibody	60 KD	Human, Mouse	WB	200ug	59670
CLSDF4884	FZD2 Antibody	55 KD	Human, Mouse,Rat	WB IF/ICC	200ug	59670
CLSDF4885	FZD3 Antibody	76 KD	Human, Mouse	WB IF/ICC	200ug	59670
CLSDF4886	FZD9 Antibody	64 KD	Human, Mouse	WB IF/ICC	200ug	59670
CLSDF4887	GPR176 Antibody	57 KD	Human, Mouse,Rat	WB IF/ICC	200ug	59670
CLSDF4888	GPR100 Antibody	38 KD	Human	WB IF/ICC	200ug	59670
CLSDF4889	GPR103 Antibody	49 KD	Human	WB	200ug	59670
CLSDF4890	GPR109 Antibody	45 KD	Human, Mouse,Rat	WB IF/ICC	200ug	59670
CLSDF4891	GPR110 Antibody	110 KD	Human	WB IF/ICC	200ug	59670
CLSDF4892	GPR119 Antibody	37 KD	Human	WB IF/ICC	200ug	59670
CLSDF4893	GPR120 Antibody	38 KD	Human, Mouse,Rat	WB IF/ICC	200ug	59670
CLSDF4894	GPR132 Antibody	42 KD	Human, Mouse	WB	200ug	59670
CLSDF4895	GPR150 Antibody	46 KD	Human	WB IF/ICC	200ug	59670
CLSDF4896	GPR151 Antibody	47 KD	Human	WB IF/ICC	200ug	59670
CLSDF4897	GPR152 Antibody	51 KD	Human	WB	200ug	59670
CLSDF4898	GPR153 Antibody	65 KD	Human, Mouse	WB IF/ICC	200ug	59670
CLSDF4899	GPR160 Antibody	38 KD	Human	WB	200ug	59670
CLSDF4900	GPR171 Antibody	37 KD	Human, Mouse	WB IF/ICC	200ug	59670
CLSDF4901	GPR173 Antibody	47 KD	Human, Mouse,Rat	WB	200ug	59670
CLSDF4902	GPR174 Antibody	34 KD	Human, Mouse	WB IF/ICC	200ug	59670
CLSDF4903	GPR175 Antibody	41 KD	Human, Mouse,Rat	WB	200ug	59670
CLSDF4904	GPR18 Antibody	35 KD	Human	WB IF/ICC	200ug	59670
CLSDF4905	ADORA1 Antibody	37 KD	Human,Rat	WB	200ug	59670
CLSDF4906	ADORA2A Antibody	45 KD	Human	WB IHC IF/ICC	200ug	59670
CLSDF4907	CHRM1 Antibody	48 KD	Human, Mouse,Rat	WB	200ug	59670

Antibodies

HSN : 38220090

Cat#	Product Description	MW	Reactivity	Application	Pack Size	Unit Price
CLSDF4908	CHRM2 Antibody	45 KD	Human, Mouse,Rat	WB IF/ICC	200ug	59670
CLSDF4909	ACTHR Antibody	34 KD	Human, Mouse	WB IF/ICC	200ug	59670
CLSDF4910	AGTR1 Antibody	41 KD	Human, Mouse,Rat	WB IF/ICC	200ug	59670
CLSDF4911	BAI1 Antibody	174 KD	Human, Mouse	WB IHC IF/ICC	200ug	59670
CLSDF4912	BRS3 Antibody	47 KD	Human	WB	200ug	59670
CLSDF4913	PTHR1 Antibody	52 KD	Human, Mouse,Rat	WB IHC IF/ICC	200ug	59670
CLSDF4914	CCKAR Antibody	44 KD	Human, Mouse,Rat	WB	200ug	59670
CLSDF4915	CG028 Antibody	56 KD	Human, Mouse	WB	200ug	59670
CLSDF4916	CLTR1 Antibody	36 KD	Human	WB IF/ICC	200ug	59670
CLSDF4917	CLTR2 Antibody	35 KD	Human	WB	200ug	59670
CLSDF4918	CNR1 Antibody	53 KD	Human, Mouse,Rat	WB IHC IF/ICC	200ug	59670
CLSDF4919	CSRL1 Antibody	83 KD	Human	WB IF/ICC	200ug	59670
CLSDF4920	EDG4 Antibody	39 KD	Human, Mouse	WB IF/ICC	200ug	59670
CLSDF4921	EDG5 Antibody	39 KD	Human, Mouse,Rat	WB	200ug	59670
CLSDF4922	EDG7 Antibody	47 KD	Human	WB IF/ICC	200ug	59670
CLSDF4923	EDNRA Antibody	48 KD	Human, Mouse	WB IF/ICC	200ug	59670
CLSDF4924	EMR2 Antibody	90 KD	Human	WB	200ug	59670
CLSDF4925	EMR4 Antibody	55 KD	Human	WB	200ug	59670
CLSDF4926	ETBR2 Antibody	52 KD	Human	WB IHC IF/ICC	200ug	59670
CLSDF4927	FSHR Antibody	70 KD	Human, Mouse,Rat	WB	200ug	59670
CLSDF4928	FZD1 Antibody	71 KD	Human	WB	200ug	59670
CLSDF4929	FZD3 Antibody	76 KD	Human, Mouse	WB IF/ICC	200ug	59670
CLSDF4930	FZD6 Antibody	79 KD	Human	WB IHC IF/ICC	200ug	59670
CLSDF4931	FZD8 Antibody	70 KD	Human, Mouse,Rat	WB	200ug	59670
CLSDF4932	FZD9 Antibody	64 KD	Human, Mouse,Rat	WB	200ug	59670
CLSDF4933	GPR137C Antibody	45 KD	Human	WB IHC IF/ICC	200ug	59670
CLSDF4934	GABBR1 Antibody	108 KD	Human, Mouse,Rat	WB IF/ICC	200ug	59670
CLSDF4935	GALR2 Antibody	42 KD	Human, Mouse,Rat	WB	200ug	59670
CLSDF4936	GHRHR Antibody	47 KD	Human, Mouse,Rat	WB IF/ICC	200ug	59670
CLSDF4937	GLR Antibody	54 KD	Human, Mouse,Rat	WB IF/ICC	200ug	59670
CLSDF4938	GPR101 Antibody	60 KD	Human, Mouse	WB IF/ICC	200ug	59670
CLSDF4939	GPR107 Antibody	67 KD	Human	WB	200ug	59670
CLSDF4940	GPR108 Antibody	60 KD	Human	WB IF/ICC	200ug	59670
CLSDF4941	GPR113 Antibody	116 KD	Human	WB	200ug	59670
CLSDF4942	GPR114 Antibody	59 KD	Human	WB	200ug	59670
CLSDF4943	GPR115 Antibody	78 KD	Human	WB	200ug	59670
CLSDF4944	GPR116 Antibody	150 KD	Human	WB IF/ICC	200ug	59670
CLSDF4945	GPR126 Antibody	145 KD	Human	WB	200ug	59670
CLSDF4946	GPR132 Antibody	42 KD	Human	WB	200ug	59670
CLSDF4947	GPR133 Antibody	96 KD	Human	WB IF/ICC	200ug	59670
CLSDF4948	GPR135 Antibody	48 KD	Human, Mouse,Rat	WB	200ug	59670
CLSDF4949	GPR142 Antibody	51 KD	Human	WB IF/ICC	200ug	59670
CLSDF4950	GPR144 Antibody	104 KD	Human	WB	200ug	59670
CLSDF4951	GPR146 Antibody	30 KD	Human	WB	200ug	59670
CLSDF4952	GPR149 Antibody	81 KD	Human	WB IF/ICC	200ug	59670
CLSDF4953	GPR151 Antibody	46 KD	Human, Mouse,Rat	WB IF/ICC	200ug	59670
CLSDF4954	GPR153 Antibody	65 KD	Human, Mouse,Rat	WB IF/ICC	200ug	59670
CLSDF4955	GPR156 Antibody	89 KD	Human	WB IF/ICC	200ug	59670
CLSDF4956	GPR157 Antibody	37 KD	Human	WB IF/ICC	200ug	59670
CLSDF4957	GPR158 Antibody	150 KD	Human, Mouse	WB IHC IF/ICC	200ug	59670
CLSDF4958	GPR171 Antibody	36 KD	Human	WB	200ug	59670
CLSDF4959	GPR173 Antibody	41 KD	Human, Mouse,Rat	WB	200ug	59670
CLSDF4960	GPR174 Antibody	39 KD	Human	WB IF/ICC	200ug	59670
CLSDF4961	GPR180 Antibody	0 KD	Human, Mouse	WB IHC IF/ICC	200ug	59670
CLSDF4962	GPRC5B Antibody	48 KD	Human	WB IF/ICC	200ug	59670
CLSDF4963	GPRC5D Antibody	43 KD	Human, Mouse	WB IF/ICC	200ug	59670
CLSDF4964	GPRC6A Antibody	105 KD	Human	WB IF/ICC	200ug	59670
CLSDF4965	GPR15 Antibody	40 KD	Human, Mouse	WB IF/ICC	200ug	59670
CLSDF4966	GPR17 Antibody	40 KD	Human	WB	200ug	59670
CLSDF4967	GPR19 Antibody	47 KD	Human, Mouse,Rat	WB	200ug	59670
CLSDF4968	GPR25 Antibody	39 KD	Human	WB	200ug	59670
CLSDF4969	GPR27 Antibody	39 KD	Human, Mouse,Rat	WB IF/ICC	200ug	59670
CLSDF4970	GPR31 Antibody	33 KD	Human	WB	200ug	59670
CLSDF4971	GPR32 Antibody	33 KD	Human	WB IF/ICC	200ug	59670
CLSDF4972	GPR34 Antibody	44 KD	Human, Mouse,Rat	WB IF/ICC	200ug	59670
CLSDF4973	GPR35 Antibody	34 KD	Human	WB IF/ICC	200ug	59670
CLSDF4974	GPR37 Antibody	67 KD	Human, Mouse,Rat	WB	200ug	59670
CLSDF4975	GPR62 Antibody	38 KD	Human	WB	200ug	59670
CLSDF4976	GPR75 Antibody	59 KD	Human, Mouse	WB IF/ICC	200ug	59670
CLSDF4977	GPR83 Antibody	48 KD	Human	WB	200ug	59670

Antibodies
HSN : 38220090

Cat#	Product Description	MW	Reactivity	Application	Pack Size	Unit Price
CLSDF4978	GPR87 Antibody	40 KD	Human, Mouse	WB IF/ICC	200ug	59670
CLSDF4979	GPR92 Antibody	40 KD	Human	WB	200ug	59670
CLSDF4980	HRH1 Antibody	60 KD	Human	WB IF/ICC	200ug	59670
CLSDF4981	HRH3 Antibody	49 KD	Human, Mouse,Rat	WB	200ug	59670
CLSDF4982	LGR4 Antibody	100 KD	Human	WB	200ug	59670
CLSDF4983	LGR6 Antibody	104 KD	Human	WB IF/ICC	200ug	59670
CLSDF4984	MC4R Antibody	37 KD	Human, Mouse,Rat	WB	200ug	59670
CLSDF4985	MC5R Antibody	40 KD	Human, Mouse,Rat	WB IF/ICC	200ug	59670
CLSDF4986	MCHR2 Antibody	39 KD	Human	WB	200ug	59670
CLSDF4987	MPRA Antibody	40 KD	Human	WB	200ug	59670
CLSDF4988	MPRG Antibody	38 KD	Human, Mouse,Rat	WB	200ug	59670
CLSDF4989	MARGRE Antibody	30 KD	Human, Mouse,Rat	WB	200ug	59670
CLSDF4990	MRGRG Antibody	34 KD	Human	WB IF/ICC	200ug	59670
CLSDF4991	MRGX1 Antibody	36 KD	Human	WB IF/ICC	200ug	59670
CLSDF4992	MSHR Antibody	35 KD	Human	WB IF/ICC	200ug	59670
CLSDF4993	MTLR Antibody	0 KD	Human	WB	200ug	59670
CLSDF4994	MTR1B Antibody	40 KD	Human	WB	200ug	59670
CLSDF4995	GPROPDR Antibody	0 KD	0	WB	200ug	59670
CLSDF4996	NK1R Antibody	50 KD	Human, Mouse,Rat	WB	200ug	59670
CLSDF4997	NK3R Antibody	52 KD	Human, Mouse,Rat	WB IF/ICC	200ug	59670
CLSDF4998	NMBR Antibody	43 KD	Human, Mouse,Rat	WB IF/ICC	200ug	59670
CLSDF4999	NPY1R Antibody	48 KD	Human, Mouse,Rat	WB	200ug	59670
CLSDF5000	NPY2R Antibody	48 43 KD	Human, Mouse,Rat	WB IF/ICC	200ug	59670
CLSDF5001	NPY5R Antibody	48 KD	Human, Mouse,Rat	WB IHC IF/ICC	200ug	59670
CLSDF5002	NTR1 Antibody	46 KD	Human, Mouse	WB	200ug	59670
CLSDF5003	OR10A4 Antibody	38 KD	Human	WB IF/ICC	200ug	59670
CLSDF5004	OR10AD1 Antibody	33 KD	Human	WB IF/ICC	200ug	59670
CLSDF5005	OR10AG1 Antibody	34 KD	Human	WB IF/ICC	200ug	59670
CLSDF5006	OR10C1 Antibody	34 KD	Human	WB	200ug	59670
CLSDF5007	OR10G2 Antibody	34 KD	Human	WB IF/ICC	200ug	59670
CLSDF5008	OR10J6 Antibody	31 KD	Human	WB IF/ICC	200ug	59670
CLSDF5009	OR11G2 Antibody	35 KD	Human	WB IF/ICC	200ug	59670
CLSDF5010	OR11L1 Antibody	34 KD	Human	WB IF/ICC	200ug	59670
CLSDF5011	OR13C3 Antibody	35 KD	Human	WB IF/ICC	200ug	59670
CLSDF5012	OR13C4 Antibody	35 KD	Human	WB IF/ICC	200ug	59670
CLSDF5013	OR2AG1/2 Antibody	34 KD	Human	WB IF/ICC	200ug	59670
CLSDF5014	OR2AJ1 Antibody	42 KD	Human	WB	200ug	59670
CLSDF5015	OR2AP1 Antibody	40 KD	Human	WB	200ug	59670
CLSDF5016	OR2T11 Antibody	35 KD	Human	WB IF/ICC	200ug	59670
CLSDF5017	OR2T2/2T35 Antibody	34 KD	Human	WB IF/ICC	200ug	59670
CLSDF5018	OR2T2/2T35 Antibody	34 KD	Human	WB	200ug	59670
CLSDF5019	OR4F4/4F5/4F17 Antibody	34 KD	Human	WB	200ug	59670
CLSDF5020	OR51E1 Antibody	35 KD	Human	WB IF/ICC	200ug	59670
CLSDF5021	OR51E2 Antibody	35 KD	Human,Rat	WB IF/ICC	200ug	59670
CLSDF5022	OR51G2 Antibody	35 KD	Human	WB	200ug	59670
CLSDF5023	OR51I2 Antibody	35 KD	Human	WB	200ug	59670
CLSDF5024	OR51T1 Antibody	37 KD	Human	WB IF/ICC	200ug	59670
CLSDF5025	OR52A4 Antibody	35 KD	Human	WB	200ug	59670
CLSDF5026	OR52B2 Antibody	36 KD	Human	WB IF/ICC	200ug	59670
CLSDF5027	OR52D1 Antibody	35 KD	Human	WB IF/ICC	200ug	59670
CLSDF5028	OR52E1 Antibody	35 KD	Human	WB IF/ICC	200ug	59670
CLSDF5029	OR52E2 Antibody	37 KD	Human	WB	200ug	59670
CLSDF5030	OR52E6 Antibody	35 KD	Human	WB	200ug	59670
CLSDF5031	OR52N4 Antibody	36 KD	Human	WB	200ug	59670
CLSDF5032	OR52W1 Antibody	34 KD	Human	WB	200ug	59670
CLSDF5033	OR56B4 Antibody	34 KD	Human	WB IF/ICC	200ug	59670
CLSDF5034	OR5AK3P Antibody	34 KD	Human	WB	200ug	59670
CLSDF5035	OR5AU1 Antibody	35 KD	Human	WB	200ug	59670
CLSDF5036	OR5H15 Antibody	32 KD	Human	WB IF/ICC	200ug	59670
CLSDF5037	OR6C68 Antibody	30 KD	Human	WB	200ug	59670
CLSDF5038	OR6C70 Antibody	35 KD	Human	WB	200ug	59670
CLSDF5039	OLFML2A Antibody	73 KD	Human	WB IF/ICC	200ug	59670
CLSDF5040	OR89 Antibody	35 KD	Human	WB	200ug	59670
CLSDF5041	OPN4 Antibody	55 KD	Human	WB	200ug	59670
CLSDF5042	OPN5 Antibody	43 KD	Human, Mouse	WB IF/ICC	200ug	59670
CLSDF5043	OPRD1 Antibody	36 KD	Human	WB	200ug	59670
CLSDF5044	OPRK1 Antibody	48 KD	Human, Mouse,Rat	WB	200ug	59670
CLSDF5045	OPRM1 Antibody	48 KD	Human	WB IHC	200ug	59670
CLSDF5046	RHO Antibody	0 KD	Human, Mouse,Rat	WB	200ug	59670



Antibodies

HSN : 38220090

Cat#	Product Description	MW	Reactivity	Application	Pack Size	Unit Price
CLSDF5047	OR10A6 Antibody	35 KD	Human	WB	200ug	59670
CLSDF5048	OR10D4 Antibody	38 KD	Human	WB IF/ICC	200ug	59670
CLSDF5049	OR10G6 Antibody	37 KD	Human	WB IF/ICC	200ug	59670
CLSDF5050	OR10H2 Antibody	38 KD	Human	WB	200ug	59670
CLSDF5051	OR10H4 Antibody	36 KD	Human	WB IF/ICC	200ug	59670
CLSDF5052	OR10J1 Antibody	30 KD	Human	WB	200ug	59670
CLSDF5053	OR10T2 Antibody	30 KD	Human	WB	200ug	59670
CLSDF5054	OR10V1 Antibody	40 KD	Human	WB IF/ICC	200ug	59670
CLSDF5055	OR13D1 Antibody	33 KD	Human	WB	200ug	59670
CLSDF5056	OR13F1 Antibody	34 KD	Human	WB	200ug	59670
CLSDF5057	OR13G1 Antibody	35 KD	Human	WB	200ug	59670
CLSDF5058	OR13H1 Antibody	35 KD	Human	WB	200ug	59670
CLSDF5059	OR1A1 Antibody	35 KD	Human	WB	200ug	59670
CLSDF5060	OR1B1 Antibody	33 KD	Human	WB IF/ICC	200ug	59670
CLSDF5061	OR1D2 Antibody	40 KD	Human	WB IF/ICC	200ug	59670
CLSDF5062	OR1L6 Antibody	34 KD	Human	WB IF/ICC	200ug	59670
CLSDF5063	OR1S1/1S2 Antibody	33 KD	Human	WB	200ug	59670
CLSDF5064	OR2A4/7 Antibody	35 KD	Human	WB IF/ICC	200ug	59670
CLSDF5065	OR2AG1/2 Antibody	35 KD	Human	WB IF/ICC	200ug	59670
CLSDF5066	OR2B2 Antibody	40 KD	Human	WB IF/ICC	200ug	59670
CLSDF5067	OR2B8 Antibody	38 KD	Human	WB	200ug	59670
CLSDF5068	OR2C1 Antibody	35 KD	Human	WB IF/ICC	200ug	59670
CLSDF5069	OR2D3 Antibody	36 KD	Human	WB IF/ICC	200ug	59670
CLSDF5070	OR2G2 Antibody	34 KD	Human	WB IF/ICC	200ug	59670
CLSDF5071	OR2G3 Antibody	35 KD	Human	WB IF/ICC	200ug	59670
CLSDF5072	OR2H2 Antibody	34 KD	Human	WB	200ug	59670
CLSDF5073	OR2I1 Antibody	34 KD	Human	WB IF/ICC	200ug	59670
CLSDF5074	OR2J2 Antibody	35 KD	Human	WB IF/ICC	200ug	59670
CLSDF5075	OR2K2 Antibody	35 KD	Human	WB IF/ICC	200ug	59670
CLSDF5076	OR2L5 Antibody	40 KD	Human	WB IF/ICC	200ug	59670
CLSDF5077	OR2M2 Antibody	34 KD	Human	WB IF/ICC	200ug	59670
CLSDF5078	OR2M7 Antibody	34 KD	Human	WB IF/ICC	200ug	59670
CLSDF5079	OR2T1 Antibody	33 KD	Human	WB IF/ICC	200ug	59670
CLSDF5080	OR2T2/35 Antibody	33 KD	Human	WB IF/ICC	200ug	59670
CLSDF5081	OR2Y1 Antibody	35 KD	Human	WB IF/ICC	200ug	59670
CLSDF5082	OR3A2 Antibody	35 KD	Human	WB IF/ICC	200ug	59670
CLSDF5083	OR4A15 Antibody	36 KD	Human	WB IF/ICC	200ug	59670
CLSDF5084	OR4A16 Antibody	38 KD	Human	WB IF/ICC	200ug	59670
CLSDF5085	OR4A4/47 Antibody	34 KD	Human	WB IF/ICC	200ug	59670
CLSDF5086	OR4C3 Antibody	36 KD	Human	WB IF/ICC	200ug	59670
CLSDF5087	OR4C6 Antibody	35 KD	Human	WB IF/ICC	200ug	59670
CLSDF5088	OR4C13 Antibody	35 KD	Human	WB IF/ICC	200ug	59670
CLSDF5089	OR4C15 Antibody	34 KD	Human	WB IF/ICC	200ug	59670
CLSDF5090	OR4C16 Antibody	35 KD	Human	WB IF/ICC	200ug	59670
CLSDF5091	OR4D1 Antibody	34 KD	Human	WB IF/ICC	200ug	59670
CLSDF5092	OR4D6 Antibody	36 KD	Human	WB	200ug	59670
CLSDF5093	OR4F4 Antibody	30 KD	Human	WB IF/ICC	200ug	59670
CLSDF5094	OR4F6 Antibody	35 KD	Human	WB IF/ICC	200ug	59670
CLSDF5095	OR4K3 Antibody	35 KD	Human	WB IF/ICC	200ug	59670
CLSDF5096	OR4L1 Antibody	34 KD	Human	WB IF/ICC	200ug	59670
CLSDF5097	OR4P4 Antibody	34 KD	Human	WB IF/ICC	200ug	59670
CLSDF5098	OR4X1 Antibody	34 KD	Human	WB IF/ICC	200ug	59670
CLSDF5099	OR51A2 Antibody	35 KD	Human	WB IF/ICC	200ug	59670
CLSDF5100	OR51A7 Antibody	35 KD	Human	WB IF/ICC	200ug	59670
CLSDF5101	OR51D1 Antibody	34 KD	Human	WB	200ug	59670
CLSDF5102	OR5A2 Antibody	36 KD	Human	WB IF/ICC	200ug	59670
CLSDF5103	OR5AR1 Antibody	35 KD	Human	WB IF/ICC	200ug	59670
CLSDF5104	OR5D13 Antibody	35 KD	Human	WB	200ug	59670
CLSDF5105	OR5D3 Antibody	27 KD	Human	WB	200ug	59670
CLSDF5106	OR5F1 Antibody	35 KD	Human	WB	200ug	59670
CLSDF5107	OR5I1 Antibody	38 KD	Human	WB IF/ICC	200ug	59670
CLSDF5108	OR5K1 Antibody	36 KD	Human	WB IF/ICC	200ug	59670
CLSDF5109	OR5K3 Antibody	37 KD	Human	WB	200ug	59670
CLSDF5110	OR5M11 Antibody	34 KD	Human	WB	200ug	59670
CLSDF5111	OR5M9 Antibody	38 KD	Human	WB IF/ICC	200ug	59670
CLSDF5112	OR5P2 Antibody	38 KD	Human	WB IF/ICC	200ug	59670
CLSDF5113	OR5P3 Antibody	34 KD	Human	WB	200ug	59670
CLSDF5114	OR5W2 Antibody	34 KD	Human	WB IF/ICC	200ug	59670
CLSDF5115	OR6A2 Antibody	36 KD	Human	WB	200ug	59670
CLSDF5116	OR6C2 Antibody	36 KD	Human	WB	200ug	59670



Antibodies

HSN : 38220090

Cat#	Product Description	MW	Reactivity	Application	Pack Size	Unit Price
CLSDF5117	OR6C3 Antibody	35 KD	Human	WB	200ug	59670
CLSDF5118	OR6K2 Antibody	37 KD	Human	WB	200ug	59670
CLSDF5119	OR6P1 Antibody	34 KD	Human	WB	200ug	59670
CLSDF5120	OR6Q1 Antibody	36 KD	Human	WB	200ug	59670
CLSDF5121	OR6S1 Antibody	36 KD	Human	WB	200ug	59670
CLSDF5122	OR6T1 Antibody	35 KD	Human	WB	200ug	59670
CLSDF5123	OR7A10 Antibody	34 KD	Human	WB	200ug	59670
CLSDF5124	OR7C1 Antibody	34 KD	Human	WB	200ug	59670
CLSDF5125	OR4K14 Antibody	37 KD	Human	WB	200ug	59670
CLSDF5126	OR8G1 Antibody	35 KD	Human	WB	200ug	59670
CLSDF5127	OR8G5 Antibody	30 KD	Human	WB	200ug	59670
CLSDF5128	OR8I2 Antibody	35 KD	Human	WB	200ug	59670
CLSDF5129	OR8J1 Antibody	35 KD	Human	WB IF/ICC	200ug	59670
CLSDF5130	OR8J3 Antibody	35 KD	Human	WB	200ug	59670
CLSDF5131	OR8S1 Antibody	40 KD	Human	WB	200ug	59670
CLSDF5132	OR9A2 Antibody	35 KD	Human	WB	200ug	59670
CLSDF5133	OR9G4 Antibody	35 KD	Human	WB	200ug	59670
CLSDF5134	OR9Q1 Antibody	33 KD	Human	WB IF/ICC	200ug	59670
CLSDF5135	OR9Q2 Antibody	38 KD	Human	WB	200ug	59670
CLSDF5136	P2RY4 Antibody	41 KD	Human, Mouse,Rat	WB	200ug	59670
CLSDF5137	P2RY8 Antibody	41 KD	Human	WB	200ug	59670
CLSDF5138	P2RY11 Antibody	48 KD	Human	WB	200ug	59670
CLSDF5139	P2RY13 Antibody	38 KD	Human,Rat	WB	200ug	59670
CLSDF5140	PTGER2 Antibody	40 KD	Human, Mouse,Rat	WB	200ug	59670
CLSDF5141	PEVR1 Antibody	46 KD	Human	WB IF/ICC	200ug	59670
CLSDF5142	PEVR2 Antibody	46 KD	Human	WB IF/ICC	200ug	59670
CLSDF5143	Prostacyclin Receptor Antibody	45 KD	Human	WB IF/ICC	200ug	59670
CLSDF5144	PKR1 Antibody	45 KD	Human, Mouse,Rat	WB	200ug	59670
CLSDF5145	PRLHR Antibody	41 KD	Human, Mouse,Rat	WB	200ug	59670
CLSDF5146	OR7E5P Antibody	26 KD	Human	WB IF/ICC	200ug	59670
CLSDF5147	GPR103 Antibody	49 KD	Human, Mouse,Rat	WB IF/ICC	200ug	59670
CLSDF5148	GPRC5A Antibody	40 KD	Human, Mouse,Rat	WB	200ug	59670
CLSDF5149	RXFP3 Antibody	51 KD	Human, Mouse,Rat	WB	200ug	59670
CLSDF5150	RXFP2 Antibody	86 KD	Human, Mouse,Rat	WB	200ug	59670
CLSDF5151	SCTR Antibody	48 KD	Human	WB	200ug	59670
CLSDF5152	SMO Antibody	86 KD	Human, Mouse,Rat	WB	200ug	59670
CLSDF5153	SSTR1 Antibody	43 KD	Human, Mouse,Rat	WB IF/ICC	200ug	59670
CLSDF5154	SSTR4 Antibody	42 KD	Human, Mouse,Rat	WB	200ug	59670
CLSDF5155	SUCNR1 Antibody	38 KD	Human, Mouse,Rat	WB	200ug	59670
CLSDF5156	TMEM185A Antibody	41 KD	Human, Mouse	WB IF/ICC	200ug	59670
CLSDF5157	TAS2R10 Antibody	35 KD	Human	WB IF/ICC	200ug	59670
CLSDF5158	TAS2R13 Antibody	35 KD	Human	WB IF/ICC	200ug	59670
CLSDF5159	TAS2R14 Antibody	38 KD	Human	WB IF/ICC	200ug	59670
CLSDF5160	TAS2R16 Antibody	34 KD	Human	WB	200ug	59670
CLSDF5161	TAS2R39 Antibody	36 KD	Human	WB IF/ICC	200ug	59670
CLSDF5162	TAS2R48 Antibody	35 KD	Human	WB	200ug	59670
CLSDF5163	TAS2R49 Antibody	38 KD	Human	WB	200ug	59670
CLSDF5164	TAS2R1 Antibody	33 KD	Human	WB	200ug	59670
CLSDF5165	TAS2R5 Antibody	35 KD	Human	WB	200ug	59670
CLSDF5166	TAS2R7 Antibody	36 KD	Human	WB IF/ICC	200ug	59670
CLSDF5167	TAS2R8 Antibody	36 KD	Human	WB	200ug	59670
CLSDF5168	TMEM145 Antibody	56 KD	Human, Mouse	WB	200ug	59670
CLSDF5169	TAS1R3 Antibody	93 KD	Human	WB IF/ICC	200ug	59670
CLSDF5170	AVPR1B Antibody	47 KD	Human	WB	200ug	59670
CLSDF5171	AVPR2 Antibody	38 KD	Human	WB IF/ICC	200ug	59670
CLSDF5172	VIPR1 Antibody	52 KD	Human, Mouse,Rat	WB IF/ICC	200ug	59670
CLSDF5173	VIPR2 Antibody	49 KD	Human, Mouse,Rat	WB IF/ICC	200ug	59670
CLSDF5174	VN1R2 Antibody	46 KD	Human	WB	200ug	59670
CLSDF5175	VN1R4 Antibody	34 KD	Human	WB IF/ICC	200ug	59670
CLSDF5176	GIPR Antibody	0 KD	Human	WB IHC IF/ICC	200ug	59670
CLSDF5177	MRGX3 Antibody	34 KD	Human	WB IF/ICC	200ug	59670
CLSDF5178	OR10A7 Antibody	36 KD	Human	WB	200ug	59670
CLSDF5179	OR10G4 Antibody	35 KD	Human	WB	200ug	59670
CLSDF5180	OR10G7 Antibody	38 KD	Human	WB IF/ICC	200ug	59670
CLSDF5181	OR10H1 Antibody	35 KD	Human	WB	200ug	59670
CLSDF5182	OR10J3 Antibody	37 KD	Human	WB	200ug	59670
CLSDF5183	OR10R2 Antibody	36 KD	Human	WB	200ug	59670
CLSDF5184	OR10S1 Antibody	35 KD	Human	WB IF/ICC	200ug	59670
CLSDF5185	OR10Z1 Antibody	38 KD	Human	WB IF/ICC	200ug	59670
CLSDF5186	OR11H1/11H2/11H12 Antibody	35 KD	Human	WB	200ug	59670



Antibodies

HSN : 38220090

Cat#	Product Description	MW	Reactivity	Application	Pack Size	Unit Price
CLSDF5187	OR51B5 Antibody	35 KD	Human	WB IF/ICC	200ug	59670
CLSDF5188	OR51B6 Antibody	35 KD	Human	WB IF/ICC	200ug	59670
CLSDF5189	OR51F1 Antibody	34 KD	Human	WB IF/ICC	200ug	59670
CLSDF5190	OR51H1 Antibody	34 KD	Human	WB	200ug	59670
CLSDF5191	OR52A1 Antibody	35 KD	Human	WB IF/ICC	200ug	59670
CLSDF5192	OR52A5 Antibody	36 KD	Human	WB	200ug	59670
CLSDF5193	OR52E4 Antibody	35 KD	Human	WB IF/ICC	200ug	59670
CLSDF5194	OR52E5 Antibody	36 KD	Human	WB	200ug	59670
CLSDF5195	OR52N1 Antibody	36 KD	Human	WB IF/ICC	200ug	59670
CLSDF5196	MAGEA5 Antibody	36 KD	Human	WB	200ug	59670
CLSDF5197	OR10H3/10H4 Antibody	38 KD	Human	WB	200ug	59670
CLSDF5198	OR12D3 Antibody	35 KD	Human	WB	200ug	59670
CLSDF5199	OR2F2 Antibody	32 KD	Human	WB	200ug	59670
CLSDF5200	OR2W3 Antibody	35 KD	Human	WB	200ug	59670
CLSDF5201	OR51A4 Antibody	35 KD	Human	WB IF/ICC	200ug	59670
CLSDF5202	OR51B2 Antibody	38 KD	Human	WB IF/ICC	200ug	59670
CLSDF5203	OR5A1 Antibody	36 KD	Human	WB	200ug	59670
CLSDF5204	OR5D16 Antibody	38 KD	Human	WB	200ug	59670
CLSDF5205	OR5M1/5M10 Antibody	36 KD	Human	WB IF/ICC	200ug	59670
CLSDF5206	OR6J1 Antibody	39 KD	Human	WB IF/ICC	200ug	59670
CLSDF5207	OR8B4 Antibody	40 KD	Human	WB IF/ICC	200ug	59670
CLSDF5208	OR8D1 Antibody	34 KD	Human	WB IF/ICC	200ug	59670
CLSDF5209	OR8G2 Antibody	33 KD	Human	WB IF/ICC	200ug	59670
CLSDF5210	OR8K3 Antibody	33 KD	Human	WB IF/ICC	200ug	59670
CLSDF5211	OXER1 Antibody	46 KD	Human	WB IF/ICC	200ug	59670
CLSDF5212	PAR4 Antibody	41 KD	Human, Mouse,Rat	WB IF/ICC	200ug	59670
CLSDF5213	PTGDR Antibody	40 KD	Human	WB IF/ICC	200ug	59670
CLSDF5214	OR10X1 Antibody	28 KD	Human	WB IF/ICC	200ug	59670
CLSDF5215	TAS2R45 Antibody	34 KD	Human	WB	200ug	59670
CLSDF5216	U12 Antibody	40 KD	Human	WB	200ug	59670
CLSDF5217	US28 Antibody	40 KD	Human	WB	200ug	59670
CLSDF5218	HCRTR1 Antibody	50 KD	Human, Mouse,Rat	WB	200ug	59670
CLSDF6001	STAT1 Antibody	83kDa	Human Mouse Rat	WB IHC	200ug	59670
CLSDF6002	PIK3R1 Antibody	85kDa	Human Mouse Rat	WB IHC	200ug	59670
CLSDF6003	PHB Antibody	30kDa	Human Mouse Rat	WB IHC	200ug	59670
CLSDF6004	PRF1 Antibody	61kDa	Human Mouse Rat	WB IHC	200ug	59670
CLSDF6005	SPHK1 Antibody	43kDa	Human Mouse Rat	WB IHC	200ug	59670
CLSDF6006	GDF15 Antibody	34.15kDa	Human Mouse Rat	WB IHC	200ug	59670
CLSDF6007	AFP Antibody	65kDa	Human Mouse Rat	WB IHC IF	200ug	59670
CLSDF6008	ATF4 Antibody	39kDa	Human Mouse Rat	WB IHC	200ug	59670
CLSDF6009	ATF6 Antibody	75kDa	Human Mouse Rat	WB IHC	200ug	59670
CLSDF6010	ATG5 Antibody	32kDa	Human Mouse Rat	WB IHC	200ug	59670
CLSDF6011	BAK1 Antibody	23kDa	Human Mouse Rat	WB	200ug	59670
CLSDF6012	APP Antibody	87kDa	Human Mouse Rat	WB IHC IF	200ug	59670
CLSDF6013	Bax Antibody	21kDa	Human Mouse Rat	WB IHC	200ug	59670
CLSDF6014	Bcl-2 Antibody	26kDa	Human Mouse Rat	WB IHC	200ug	59670
CLSDF6015	BCL2L1 Antibody	26kDa	Human Mouse Rat	WB IHC	200ug	59670
CLSDF6016	BID Antibody	22kDa	Human Mouse Rat	WB IHC	200ug	59670
CLSDF6017	BMI1 Antibody	37kDa	Human Mouse Rat	WB IHC	200ug	59670
CLSDF6018	BRCA1 Antibody	208kDa	Human	WB	200ug	59670
CLSDF6019	BVES Antibody	41kDa	Human Mouse Rat	WB IHC	200ug	59670
CLSDF6020	CASP3 Antibody	32kDa	Human Mouse Rat	WB IHC	200ug	59670
CLSDF6021	CASP10 Antibody	59kDa	Human Mouse Rat	WB IHC	200ug	59670
CLSDF6022	CD40 Antibody	31kDa	Human Mouse Rat	WB	200ug	59670
CLSDF6023	CD133 Antibody	97kDa	Human Mouse Rat	WB	200ug	59670
CLSDF6024	CDK1 Antibody	34kDa	Human Mouse Rat	WB IHC	200ug	59670
CLSDF6025	CHOP Antibody	19kDa	Human Mouse Rat	WB IHC	200ug	59670
CLSDF6026	c-Raf Antibody	73kDa	Human Mouse Rat	WB	200ug	59670
CLSDF6027	CRP Antibody	25kDa	Human Mouse Rat	WB IHC	200ug	59670
CLSDF6028	CYCS Antibody	12kDa	Human Mouse Rat	WB IHC	200ug	59670
CLSDF6029	DOK4 Antibody	37kDa	Human Mouse Rat	WB IHC	200ug	59670
CLSDF6030	MAPK14 Antibody	41kDa	Human Mouse Rat	WB IHC	200ug	59670
CLSDF6031	MAPK3 Antibody	43kDa	Human Mouse Rat	WB IHC	200ug	59670
CLSDF6032	MAPK1 Antibody	41kDa	Human Mouse Rat	WB IHC	200ug	59670
CLSDF6033	SIRT1 Antibody	82kDa	Human Mouse Rat	WB IHC	200ug	59670
CLSDF6034	BMP2 Antibody	44kDa	Human Mouse Rat	WB IHC	200ug	59670
CLSDF6035	FABP4 Antibody	15kDa	Human Mouse Rat	WB IHC	200ug	59670
CLSDF6036	FAS Antibody	38kDa	Human	WB	200ug	59670
CLSDF6037	FasL Antibody	31kDa	Human Mouse Rat	WB	200ug	59670
CLSDF6038	FGF2 Antibody	21kDa	Human Mouse Rat	WB IHC	200ug	59670



Antibodies

HSN : 38220090

Cat#	Product Description	MW	Reactivity	Application	Pack Size	Unit Price
CLSDF6039	FOS Antibody	41kDa	Human Mouse Rat	WB IHC	200ug	59670
CLSDF6040	GFAP Antibody	50kDa	Human Mouse Rat	WB IHC IF	200ug	59670
CLSDF6041	HDAC1 Antibody	55kDa	Human Mouse Rat	WB IHC IF	200ug	59670
CLSDF6042	HDAC4 Antibody	119kDa	Human Mouse Rat	WB IHC	200ug	59670
CLSDF6043	HSP27 Antibody	27kDa	Human Mouse Rat	WB	200ug	59670
CLSDF6044	BIP Antibody	78kDa	Human Mouse Rat	WB IHC	200ug	59670
CLSDF6045	IFN-γ Antibody	19kDa	Human Mouse Rat	WB	200ug	59670
CLSDF6046	IGF1R Antibody	155kDa	Human Mouse Rat	WB	200ug	59670
CLSDF6047	IKBKE Antibody	80kDa	Human Mouse Rat	WB IHC	200ug	59670
CLSDF6048	IRS1 Antibody	132kDa	Human Mouse Rat	WB	200ug	59670
CLSDF6049	JUN Antibody	36kDa	Human Mouse Rat	WB	200ug	59670
CLSDF6050	KRT19 Antibody	40kDa	Human Mouse Rat	WB IHC	200ug	59670
CLSDF6051	KRT20 Antibody	48kDa	Human Mouse Rat	WB IHC	200ug	59670
CLSDF6052	LMNA Antibody	65kDa	Human Mouse Rat	WB IHC	200ug	59670
CLSDF6053	MCL1 Antibody	37kDa	Human Mouse Rat	WB	200ug	59670
CLSDF6054	MDK Antibody	16kDa	Human Mouse Rat	WB IHC	200ug	59670
CLSDF6055	MEK1 Antibody	43kDa	Human Mouse Rat	WB	200ug	59670
CLSDF6056	MEK2 Antibody	44kDa	Human Mouse Rat	WB	200ug	59670
CLSDF6057	MLH1 Antibody	85kDa	Human Mouse Rat	WB	200ug	59670
CLSDF6058	MTM1 Antibody	70kDa	Human Mouse Rat	WB IHC	200ug	59670
CLSDF6059	NAMPT Antibody	52kDa	Human Mouse Rat	WB IHC	200ug	59670
CLSDF6060	NEFL Antibody	62kDa	Human Mouse Rat	WB IHC	200ug	59670
CLSDF6061	NGF Antibody	27kDa	Human Mouse Rat	WB IHC	200ug	59670
CLSDF6062	NME1 Antibody	17kDa	Human Mouse Rat	WB IHC	200ug	59670
CLSDF6063	NUDT6 Antibody	36kDa	Human Mouse Rat	WB IHC	200ug	59670
CLSDF6064	OLFM1 Antibody	55kDa	Human Mouse Rat	WB IHC	200ug	59670
CLSDF6065	P16 Antibody	11kDa	Human	WB IHC	200ug	59670
CLSDF6066	p53 Antibody	44kDa	Human	WB IHC	200ug	59670
CLSDF6067	PCNA Antibody	29/31kDa	Human Mouse Rat	WB IHC	200ug	59670
CLSDF6068	PIK3CA Antibody	124kDa	Human Mouse Rat	WB	200ug	59670
CLSDF6069	PIK3CG Antibody	126kDa	Human Mouse Rat	WB	200ug	59670
CLSDF6070	PRKCA Antibody	77kDa	Human Mouse Rat	WB IHC	200ug	59670
CLSDF6071	PKM2 Antibody	58kDa	Human Mouse Rat	WB IHC	200ug	59670
CLSDF6072	POLR1C Antibody	39kDa	Human Mouse Rat	WB IHC	200ug	59670
CLSDF6073	PPARG Antibody	58kDa	Human Mouse Rat	WB IHC	200ug	59670
CLSDF6074	PSME3 Antibody	30kDa	Human Mouse Rat	WB IHC	200ug	59670
CLSDF6075	RhoA Antibody	22kDa	Human Mouse Rat	WB	200ug	59670
CLSDF6076	SIRT2 Antibody	43kDa	Human Mouse Rat	WB IHC	200ug	59670
CLSDF6077	SOD1 Antibody	16kDa	Human Mouse Rat	WB IHC	200ug	59670
CLSDF6078	STAT5B Antibody	90kDa	Human Mouse Rat	WB IHC	200ug	59670
CLSDF6079	TBRG4 Antibody	71kDa	Human Mouse Rat	WB IHC	200ug	59670
CLSDF6080	TNF Antibody	26kDa	Human Mouse Rat	WB IHC	200ug	59670
CLSDF6081	TUBA4A Antibody	55kDa	Human Mouse Rat	WB IHC	200ug	59670
CLSDF6082	VCAM1 Antibody	81kDa	Human Mouse Rat	WB IHC	200ug	59670
CLSDF6083	ABL1 Antibody	123kDa	Human Mouse Rat	WB	200ug	59670
CLSDF6084	ASK1 Antibody	155kDa	Human Mouse Rat	WB	200ug	59670
CLSDF6085	HSP70 Antibody	70kDa	Human Mouse Rat	WB	200ug	59670
CLSDF6086	IFN-α Antibody	22kDa	Human Mouse Rat	WB	200ug	59670
CLSDF6087	IL-6 Antibody	24kDa	Human Mouse Rat	WB	200ug	59670
CLSDF6088	Insulin Receptor β Antibody	152kDa	Human	WB	200ug	59670
CLSDF6089	JNK1 Antibody	48kDa	Human Mouse Rat	WB	200ug	59670
CLSDF6090	p27 Antibody	27kDa	Human Mouse Rat	WB	200ug	59670
CLSDF6091	TREM1 Antibody	26kDa	Human Mouse Rat	WB	200ug	59670
CLSDF6092	CARD8 Antibody	49kDa	Human	WB IHC	200ug	59670
CLSDF6093	Bim Antibody	22kDa	Human Mouse Rat	WB	200ug	59670
CLSDF6094	ESR1 Antibody	66kDa	Human Mouse Rat	WB	200ug	59670
CLSDF6095	IL2 Antibody	18kDa	Human	WB IHC ICC	200ug	59670
CLSDF6096	IGF-1 Antibody	17kDa	Human Mouse Rat	WB IHC	200ug	59670
CLSDF6097	CD40LG Antibody	29kDa	Human Mouse Rat	WB IHC	200ug	59670
CLSDF6098	AKT2 Antibody	56kDa	Human Mouse Rat	WB IHC	200ug	59670
CLSDF6099	TGFA Antibody	17kDa	Human Mouse Rat	WB IHC	200ug	59670
CLSDF6100	MDM2 Antibody	55kDa	Human Mouse Rat	WB	200ug	59670
CLSDF6101	HSP90AA1 Antibody	90kDa	Human Mouse Rat	WB IHC	200ug	59670
CLSDF6102	CDK4 Antibody	34kDa	Human Mouse Rat	WB IHC	200ug	59670
CLSDF6103	RARA Antibody	51kDa	Human Mouse Rat	WB IHC	200ug	59670
CLSDF6104	VHL Antibody	24kDa	Human Mouse Rat	WB IHC	200ug	59670
CLSDF6105	NTF3 Antibody	29kDa	Human Mouse Rat	WB IHC	200ug	59670
CLSDF6106	FASN Antibody	272kDa	Human Mouse Rat	WB IHC	200ug	59670
CLSDF6107	DDX58 Antibody	107kDa	Human Mouse Rat	WB IHC	200ug	59670
CLSDF6108	HSPA9 Antibody	74kDa	Human Mouse Rat	WB IHC	200ug	59670



Antibodies

HSN : 38220090

Cat#	Product Description	MW	Reactivity	Application	Pack Size	Unit Price
CLSDF6109	SOX2 Antibody	34kDa	Human Mouse Rat	WB IHC	200ug	59670
CLSDF6110	PEBP1 Antibody	21kDa	Human Mouse Rat	WB IHC	200ug	59670
CLSDF6111	GNAZ Antibody	41kDa	Human Mouse Rat	WB IHC	200ug	59670
CLSDF6112	TCL1A Antibody	13kDa	Human Mouse Rat	WB IHC	200ug	59670
CLSDF6113	WNT3A Antibody	39kDa	Human Mouse Rat	WB IHC	200ug	59670
CLSDF6114	TNFRSF6B Antibody	33kDa	Human	WB IHC	200ug	59670
CLSDF6115	CDCA8 Antibody	31kDa	Human Mouse Rat	WB IHC	200ug	59670
CLSDF6116	S100B Antibody	11kDa	Human Mouse Rat	WB IHC	200ug	59670
CLSDF6117	GATA2 Antibody	49kDa	Human Mouse Rat	WB IHC	200ug	59670
CLSDF6118	ACVR1C Antibody	55kDa	Human Mouse Rat	WB IHC	200ug	59670
CLSDF6119	FAIM Antibody	20kDa	Human Mouse Rat	WB	200ug	59670
CLSDF6120	PSMG2 Antibody	29kDa	Human Mouse Rat	WB IHC	200ug	59670
CLSDF6121	SMNDC1 Antibody	27kDa	Human Mouse Rat	WB IHC	200ug	59670
CLSDF6122	STEAP3 Antibody	55kDa	Human Mouse Rat	WB IHC	200ug	59670
CLSDF6123	TCTN3 Antibody	66kDa	Human Mouse Rat	WB IHC	200ug	59670
CLSDF6124	FGF1 Antibody	17kDa	Human Mouse	WB	200ug	59670
CLSDF6125	EDN1 Antibody	24kDa	Human Mouse Rat	WB IHC	200ug	59670
CLSDF6126	NRG1 Antibody	32kDa	Human Mouse Rat	WB IHC	200ug	59670
CLSDF6127	IL17A Antibody	18kDa	Human Mouse Rat	WB IHC IF	200ug	59670
CLSDF6128	ANGPTL3 Antibody	54kDa	Human Mouse Rat	WB	200ug	59670
CLSDF6129	ATG13 Antibody	57kDa	Human Mouse Rat	WB IHC	200ug	59670
CLSDF6130	ATG7 Antibody	78kDa	Human Mouse Rat	WB IHC	200ug	59670
CLSDF6131	P4HB Antibody	57kDa	Human Mouse Rat	WB	200ug	59670
CLSDF6132	MGMT Antibody	22kDa	Human Mouse Rat	WB IHC	200ug	59670
CLSDF6133	SOCS3 Antibody	25kDa	Human Mouse Rat	WB IHC	200ug	59670
CLSDF6134	MMP7 Antibody	29kDa	Human Mouse Rat	WB IHC	200ug	59670
CLSDF6135	ITGA4 Antibody	115kDa	Human Mouse Rat	WB IHC	200ug	59670
CLSDF6136	BMP7 Antibody	49kDa	Human Mouse Rat	WB	200ug	59670
CLSDF6137	ANGPT2 Antibody	57kDa	Human Mouse Rat	WB IHC	200ug	59670
CLSDF6138	DES Antibody	54kDa	Human Mouse Rat	WB IHC	200ug	59670
CLSDF6139	CD34 Antibody	41kDa	Human Mouse Rat	WB IHC	200ug	59670
CLSDF6140	VDAC1 Antibody	31kDa	Human Mouse Rat	WB IHC	200ug	59670
CLSDF6141	ILK Antibody	59kDa	Human Mouse Rat	WB IHC	200ug	59670
CLSDF6142	PRKAR1A Antibody	43kDa	Human Mouse Rat	WB IHC	200ug	59670
CLSDF6143	IKBK Antibody	48kDa	Human Mouse Rat	WB IHC	200ug	59670
CLSDF6144	ERBB3 Antibody	148kDa	Human Mouse Rat	WB IHC	200ug	59670
CLSDF6145	NeuN Antibody	34kDa	Human Mouse Rat	WB IHC	200ug	59670
CLSDF6146	TRAF2 Antibody	56kDa	Human Mouse Rat	WB IHC	200ug	59670
CLSDF6147	JUP Antibody	82kDa	Human Mouse Rat	WB IHC	200ug	59670
CLSDF6148	CASP1 Antibody	45kDa	Human Mouse Rat	WB IHC	200ug	59670
CLSDF6149	CTSB Antibody	38kDa	Human Mouse Rat	WB IHC	200ug	59670
CLSDF6150	PARK2 Antibody	52kDa	Human Mouse Rat	WB IHC	200ug	59670
CLSDF6151	HSPD1 Antibody	61kDa	Human Mouse	WB IHC	200ug	59670
CLSDF6152	CEACAM5 Antibody	77kDa	Human	WB IHC	200ug	59670
CLSDF6153	GAD2 Antibody	65kDa	Human Mouse Rat	WB IHC	200ug	59670
CLSDF6154	ARNT Antibody	87kDa	Human Mouse Rat	WB IHC	200ug	59670
CLSDF6155	TRAF6 Antibody	60kDa	Human Mouse Rat	WB IHC	200ug	59670
CLSDF6156	EEF1A1 Antibody	50kDa	Human Mouse Rat	WB IHC	200ug	59670
CLSDF6157	RAP1A Antibody	21kDa	Human Mouse Rat	WB IHC	200ug	59670
CLSDF6158	RAN Antibody	25kDa	Human Mouse Rat	WB IHC	200ug	59670
CLSDF6159	SNX9 Antibody	67kDa	Human Mouse Rat	WB IHC	200ug	59670
CLSDF6160	WAS Antibody	53kDa	Human Mouse Rat	WB IHC	200ug	59670
CLSDF6161	SIRT7 Antibody	45kDa	Human Mouse Rat	WB IHC	200ug	59670
CLSDF6162	MyD88 Antibody	33kDa	Human Mouse Rat	WB IHC	200ug	59670
CLSDF6163	TGM2 Antibody	77kDa	Human Mouse Rat	WB IHC	200ug	59670
CLSDF6164	PIK3CB Antibody	123kDa	Human Mouse Rat	WB IHC	200ug	59670
CLSDF6165	MSH6 Antibody	153kDa	Human Mouse Rat	WB IHC	200ug	59670
CLSDF6166	NEK8 Antibody	75kDa	Human Mouse Rat	WB IHC	200ug	59670
CLSDF6167	BIRC2 Antibody	70kDa	Human Mouse Rat	WB IHC	200ug	59670
CLSDF6168	SNAP25 Antibody	25kDa	Human Mouse Rat	WB IHC	200ug	59670
CLSDF6169	PARK7 Antibody	20kDa	Human Mouse Rat	WB IHC	200ug	59670
CLSDF6170	ARF6 Antibody	20kDa	Human Mouse Rat	WB IHC	200ug	59670
CLSDF6171	HSP90B1 Antibody	92kDa	Human Mouse Rat	WB IHC	200ug	59670
CLSDF6172	RPA1 Antibody	68kDa	Human Mouse Rat	WB IHC	200ug	59670
CLSDF6173	TLR7 Antibody	121kDa	Human Mouse Rat	WB IHC	200ug	59670
CLSDF6174	SYT1 Antibody	48kDa	Human Mouse Rat	WB IHC	200ug	59670
CLSDF6175	PPIA Antibody	18kDa	Human Mouse Rat	WB IHC	200ug	59670
CLSDF6176	HK2 Antibody	102kDa	Human Mouse Rat	WB IHC	200ug	59670
CLSDF6177	CCNH Antibody	38kDa	Human Mouse Rat	WB IHC	200ug	59670
CLSDF6178	ID2 Antibody	18kDa	Human Mouse Rat	WB IHC	200ug	59670



Antibodies

HSN : 38220090

Cat#	Product Description	MW	Reactivity	Application	Pack Size	Unit Price
CLSDf6179	TLR1 Antibody	90kDa	Human Mouse Rat	WB IHC	200ug	59670
CLSDf6180	ARRB1 Antibody	47kDa	Human Mouse Rat	WB IHC	200ug	59670
CLSDf6181	NCK1 Antibody	43kDa	Human Mouse Rat	WB IHC	200ug	59670
CLSDf6182	SERPINA1 Antibody	47kDa	Human Mouse Rat	WB IHC	200ug	59670
CLSDf6183	TPMT Antibody	28kDa	Human Mouse Rat	WB IHC	200ug	59670
CLSDf6184	ADA Antibody	41kDa	Human Mouse Rat	WB IHC	200ug	59670
CLSDf6185	SERPINA3 Antibody	48kDa	Human Mouse Rat	WB IHC	200ug	59670
CLSDf6186	YWHAB Antibody	6kDa	Human Mouse Rat	WB IHC	200ug	59670
CLSDf6187	KRT8 Antibody	54kDa	Human Mouse Rat	WB IHC	200ug	59670
CLSDf6188	SGK1 Antibody	49kDa	Human Mouse Rat	WB IHC	200ug	59670
CLSDf6189	SFN Antibody	28kDa	Human Mouse Rat	WB IHC	200ug	59670
CLSDf6190	CA1 Antibody	29kDa	Human Mouse Rat	WB IHC	200ug	59670
CLSDf6191	ENO1 Antibody	47kDa	Human Mouse Rat	WB IHC	200ug	59670
CLSDf6192	STAR Antibody	32kDa	Human Mouse Rat	WB IHC	200ug	59670
CLSDf6193	PSMB1 Antibody	26kDa	Human Mouse Rat	WB IHC	200ug	59670
CLSDf6194	EDN3 Antibody	26kDa	Human Mouse Rat	WB IHC	200ug	59670
CLSDf6195	U2AF1 Antibody	28kDa	Human Mouse Rat	WB IHC	200ug	59670
CLSDf6196	RAD1 Antibody	30-40kDa	Human Mouse Rat	WB IHC	200ug	59670
CLSDf6197	MTAP Antibody	31kDa	Human Mouse Rat	WB IHC	200ug	59670
CLSDf6198	IRF4 Antibody	52kDa	Human Mouse Rat	WB IHC	200ug	59670
CLSDf6199	HK1 Antibody	102kDa	Human Mouse Rat	WB IHC	200ug	59670
CLSDf6200	PRMT1 Antibody	42kDa	Human Mouse Rat	WB IHC	200ug	59670
CLSDf6201	MCM2 Antibody	102kDa	Human Mouse Rat	WB IHC	200ug	59670
CLSDf6202	SNAI2 Antibody	30kDa	Human Mouse Rat	WB IHC	200ug	59670
CLSDf6203	YWHAE Antibody	29kDa	Human Mouse Rat	WB IHC	200ug	59670
CLSDf6204	MLST8 Antibody	36kDa	Human Mouse Rat	WB IHC	200ug	59670
CLSDf6205	MCM3 Antibody	91kDa	Human Mouse Rat	WB IHC	200ug	59670
CLSDf6206	PSMD4 Antibody	41kDa	Human Mouse Rat	WB IHC	200ug	59670
CLSDf6207	RHOC Antibody	22kDa	Human Mouse Rat	WB IHC	200ug	59670
CLSDf6208	PPP3CA Antibody	61kDa	Human Mouse Rat	WB IHC	200ug	59670
CLSDf6209	ACTR3 Antibody	47kDa	Human Mouse Rat	WB IHC	200ug	59670
CLSDf6210	TDGF1 Antibody	21kDa	Human Mouse Rat	WB IHC	200ug	59670
CLSDf6211	CALR Antibody	60kDa	Human Mouse Rat	WB IHC	200ug	59670
CLSDf6212	LYZL6 Antibody	17kDa	Human Mouse Rat	WB IHC	200ug	59670
CLSDf6213	AKR1A1 Antibody	37kDa	Human Mouse Rat	WB IHC	200ug	59670
CLSDf6214	GSS Antibody	52kDa	Human Mouse Rat	WB IHC	200ug	59670
CLSDf6215	ARPC1A Antibody	42kDa	Human Mouse Rat	WB IHC	200ug	59670
CLSDf6216	CSRP1 Antibody	21kDa	Human Mouse Rat	WB IHC	200ug	59670
CLSDf6217	RNASE12 Antibody	17kDa	Human Mouse Rat	WB IHC	200ug	59670
CLSDf6218	RNASE13 Antibody	18kDa	Human Mouse Rat	WB IHC	200ug	59670
CLSDf6219	DEFB132 Antibody	11kDa	Human	WB IHC	200ug	59670
CLSDf6220	GPX5 Antibody	25kDa	Human Mouse Rat	WB IHC	200ug	59670
CLSDf6221	HADH Antibody	34kDa	Human Mouse	WB IHC	200ug	59670
CLSDf6222	SLC27A2 Antibody	65kDa	Human Mouse Rat	WB IHC	200ug	59670
CLSDf6223	CUL3 Antibody	89kDa	Human Mouse Rat	WB IHC	200ug	59670
CLSDf6224	NUAK2 Antibody	70kDa	Human Mouse Rat	WB IHC	200ug	59670
CLSDf6225	ALPL Antibody	57kDa	Human Mouse Rat	WB IHC	200ug	59670
CLSDf6226	NTF4 Antibody	22kDa	Human Mouse Rat	WB IHC	200ug	59670
CLSDf6227	FAM3B Antibody	26kDa	Human Mouse Rat	WB IHC	200ug	59670
CLSDf6228	AMBRA1 Antibody	133kDa	Human Mouse Rat	WB IHC	200ug	59670
CLSDf6229	CCND3 Antibody	33kDa	Human Mouse Rat	WB IHC	200ug	59670
CLSDf6230	PDIA3 Antibody	57kDa	Human Mouse Rat	WB IHC	200ug	59670
CLSDf6231	UBE2K Antibody	22kDa	Human Mouse Rat	WB IHC	200ug	59670
CLSDf6232	HSP90AB1 Antibody	83kDa	Human Mouse Rat	WB IHC	200ug	59670
CLSDf6233	PPP1CB Antibody	37kDa	Human Mouse	WB IHC	200ug	59670
CLSDf6234	RNASE11 Antibody	22kDa	Human	WB IHC	200ug	59670
CLSDf6235	MAGED1 Antibody	86kDa	Human Mouse Rat	WB IHC	200ug	59670
CLSDf6236	C19orf10 Antibody	19kDa	Human Mouse Rat	WB IHC	200ug	59670
CLSDf6237	TYMP Antibody	50kDa	Human Mouse Rat	WB IHC	200ug	59670
CLSDf6238	TNFRSF1B Antibody	48kDa	Human Mouse Rat	WB IHC	200ug	59670
CLSDf6239	SPINK1 Antibody	9kDa	Human Mouse Rat	WB IHC	200ug	59670
CLSDf6240	ATP2A2 Antibody	115kDa	Human Mouse Rat	WB IHC	200ug	59670
CLSDf6241	CBX5 Antibody	22kDa	Human Mouse Rat	WB IHC	200ug	59670
CLSDf6242	NCSTN Antibody	77kDa	Human Mouse Rat	WB IHC	200ug	59670
CLSDf6243	SMAD1 Antibody	52kDa	Human Mouse Rat	WB IHC	200ug	59670
CLSDf6244	MAPT Antibody	83kDa	Human Mouse Rat	WB IHC	200ug	59670
CLSDf6245	BAG1 Antibody	39kDa	Human Mouse Rat	WB IHC	200ug	59670
CLSDf6246	BCL10 Antibody	26kDa	Human Mouse Rat	WB IHC	200ug	59670
CLSDf6247	ARHGEF7 Antibody	90kDa	Human Mouse Rat	WB IHC	200ug	59670
CLSDf6248	BCL2L13 Antibody	53kDa	Human Mouse Rat	WB IHC	200ug	59670

Antibodies
HSN : 38220090

Cat#	Product Description	MW	Reactivity	Application	Pack Size	Unit Price
CLSDF6249	GPX1 Antibody	22kDa	Human Mouse Rat	WB IHC	200ug	59670
CLSDF6250	CYR61 Antibody	42kDa	Human	WB IHC	200ug	59670
CLSDF6251	IL1B Antibody	31kDa	Human Mouse Rat	WB IHC	200ug	59670
CLSDF6252	IL18 Antibody	22kDa	Human Mouse Rat	WB IHC	200ug	59670
CLSDF6253	APEX1 Antibody	36kDa	Human Mouse Rat	WB IHC	200ug	59670
CLSDF6254	ANXA1 Antibody	39kDa	Human Mouse Rat	WB	200ug	59670
CLSDF6255	GCG Antibody	21kDa	Human Mouse Rat	WB IHC	200ug	59670
CLSDF6256	TTR Antibody	16kDa	Human Mouse Rat	WB IHC	200ug	59670
CLSDF6257	MSH2 Antibody	105kDa	Human Mouse Rat	WB IHC	200ug	59670
CLSDF6258	CRH Antibody	21kDa	Human Mouse Rat	WB IHC	200ug	59670
CLSDF6259	ATG4C Antibody	52kDa	Human Mouse Rat	WB IHC	200ug	59670
CLSDF6260	CRADD Antibody	23kDa	Human Mouse Rat	WB IHC	200ug	59670
CLSDF6261	TNNT2 Antibody	36kDa	Human Mouse Rat	WB IHC	200ug	59670
CLSDF6262	PHPT1 Antibody	14kDa	Human Mouse Rat	WB IHC	200ug	59670
CLSDF6263	NCOA1 Antibody	157kDa	Human Mouse Rat	WB IHC	200ug	59670
CLSDF6264	APOA1 Antibody	31kDa	Human Mouse Rat	WB IHC	200ug	59670
CLSDF6265	AMACR Antibody	42kDa	Human Mouse Rat	WB IHC	200ug	59670
CLSDF6266	EMD Antibody	29kDa	Human Mouse Rat	WB IHC	200ug	59670
CLSDF6267	CTCF Antibody	83kDa	Human Mouse Rat	WB IHC	200ug	59670
CLSDF6268	DCX Antibody	45kDa	Human Mouse Rat	WB IHC	200ug	59670
CLSDF6269	E2F8 Antibody	94kDa	Human Mouse Rat	WB IHC	200ug	59670
CLSDF6270	FBL Antibody	34kDa	Human Mouse Rat	WB IHC	200ug	59670
CLSDF6271	TNFRSF10C Antibody	27kDa	Human	WB IHC	200ug	59670
CLSDF6272	MCM7 Antibody	81kDa	Human Mouse Rat	WB IHC	200ug	59670
CLSDF6273	RAC2 Antibody	21kDa	Human Mouse Rat	WB IHC	200ug	59670
CLSDF6274	RALBP1 Antibody	76kDa	Human Mouse Rat	WB IHC	200ug	59670
CLSDF6275	TCF4 Antibody	71kDa	Human Mouse Rat	WB IHC	200ug	59670
CLSDF6276	ALDOA Antibody	39kDa	Human Mouse Rat	WB IHC	200ug	59670
CLSDF6277	SH2D1A Antibody	14kDa	Human Mouse Rat	WB IHC	200ug	59670
CLSDF6278	FTH1 Antibody	21kDa	Human Mouse Rat	WB IHC	200ug	59670
CLSDF6279	TRADD Antibody	34kDa	Human Mouse Rat	WB IHC	200ug	59670
CLSDF6280	LDHA Antibody	37kDa	Human Mouse Rat	WB IHC	200ug	59670
CLSDF6281	NEUROD1 Antibody	40kDa	Human Mouse Rat	WB IHC	200ug	59670
CLSDF6282	NCF1 Antibody	45kDa	Human Mouse Rat	WB IHC	200ug	59670
CLSDF6283	IRF5 Antibody	56kDa	Human Mouse Rat	WB IHC	200ug	59670
CLSDF6284	DUSP6 Antibody	42kDa	Human Mouse Rat	WB IHC	200ug	59670
CLSDF6285	EGLN1 Antibody	46kDa	Human Mouse Rat	WB IHC	200ug	59670
CLSDF6286	RRM1 Antibody	90kDa	Human Mouse Rat	WB IHC	200ug	59670
CLSDF6287	MAD1L1 Antibody	83kDa	Human Mouse Rat	WB IHC	200ug	59670
CLSDF6288	RAB7A Antibody	23kDa	Human Mouse Rat	WB IHC	200ug	59670
CLSDF6289	TICAM1 Antibody	76kDa	Human Mouse Rat	WB IHC	200ug	59670
CLSDF6290	KDM1A Antibody	95kDa	Human Mouse Rat	WB IHC	200ug	59670
CLSDF6291	TPM1 Antibody	33kDa	Human Mouse Rat	WB IHC	200ug	59670
CLSDF6292	BCL2L2 Antibody	21kDa	Human Mouse Rat	WB IHC	200ug	59670
CLSDF6293	GRIA3 Antibody	101kDa	Human Mouse Rat	WB IHC	200ug	59670
CLSDF6294	ACTN1 Antibody	103kDa	Human Mouse Rat	WB IHC	200ug	59670
CLSDF6295	CALM3 Antibody	17kDa	Human Mouse Rat	WB IHC	200ug	59670
CLSDF6296	HNRNPA2B1 Antibody	37kDa	Human Mouse Rat	WB IHC	200ug	59670
CLSDF6297	NEDD8 Antibody	9kDa	Human Mouse Rat	WB IHC	200ug	59670
CLSDF6298	PFN1 Antibody	15kDa	Human Mouse Rat	WB IHC	200ug	59670
CLSDF6299	RHEB Antibody	20kDa	Human Mouse Rat	WB IHC	200ug	59670
CLSDF6300	SMPD2 Antibody	48kDa	Human Mouse Rat	WB IHC	200ug	59670
CLSDF6301	RAB11A Antibody	24kDa	Human Mouse Rat	WB IHC	200ug	59670
CLSDF6302	GAS2 Antibody	35kDa	Human Mouse Rat	WB IHC	200ug	59670
CLSDF6303	STUB1 Antibody	35kDa	Human Mouse Rat	WB IHC	200ug	59670
CLSDF6304	PYCARD Antibody	25kDa	Human Mouse Rat	WB IHC	200ug	59670
CLSDF6305	ARRB2 Antibody	46kDa	Human Mouse Rat	WB IHC	200ug	59670
CLSDF6306	CAPN1 Antibody	82kDa	Human Mouse Rat	WB IHC	200ug	59670
CLSDF6307	CDC25A Antibody	59kDa	Human Mouse Rat	WB IHC	200ug	59670
CLSDF6308	FAAH Antibody	63kDa	Human Mouse Rat	WB IHC	200ug	59670
CLSDF6309	FEN1 Antibody	43kDa	Human Mouse Rat	WB IHC	200ug	59670
CLSDF6310	KCNE1 Antibody	15kDa	Human Mouse Rat	WB IHC	200ug	59670
CLSDF6311	TACSTD1 Antibody	35kDa	Human Mouse Rat	WB IHC	200ug	59670
CLSDF6312	NCF2 Antibody	60kDa	Human Mouse Rat	WB IHC	200ug	59670
CLSDF6313	SERPINB5 Antibody	42kDa	Human Mouse Rat	WB IHC	200ug	59670
CLSDF6314	RAB5A Antibody	24kDa	Human Mouse Rat	WB IHC	200ug	59670
CLSDF6315	REL Antibody	69kDa	Human Mouse Rat	WB IHC	200ug	59670
CLSDF6316	ISG15 Antibody	18kDa	Human Mouse Rat	WB IHC	200ug	59670
CLSDF6317	TARDBP Antibody	43kDa	Human Mouse Rat	WB IHC	200ug	59670
CLSDF6318	PML Antibody	98kDa	Human Mouse Rat	WB IHC	200ug	59670

Antibodies
HSN : 38220090

Cat#	Product Description	MW	Reactivity	Application	Pack Size	Unit Price
CLSDF6319	CALM1 Antibody	17kDa	Human Mouse Rat	WB IHC	200ug	59670
CLSDF6320	GGA2 Antibody	67kDa	Human Mouse Rat	WB IHC	200ug	59670
CLSDF6321	NFKBIA Antibody	39kDa	Human Mouse Rat	WB IHC	200ug	59670
CLSDF6322	CDC42 Antibody	21kDa	Human Mouse Rat	WB IHC	200ug	59670
CLSDF6323	CREB1 Antibody	35kDa	Human Mouse Rat	WB IHC	200ug	59670
CLSDF6324	KRAS Antibody	21kDa	Human Mouse Rat	WB IHC	200ug	59670
CLSDF6325	MMP1 Antibody	54kDa	Human	WB IHC	200ug	59670
CLSDF6326	HGF Antibody	83kDa	Human Mouse Rat	WB IHC	200ug	59670
CLSDF6327	FIGF Antibody	40kDa	Human Mouse Rat	WB IHC	200ug	59670
CLSDF6328	PDGFB Antibody	27kDa	Human Mouse Rat	WB IHC	200ug	59670
CLSDF6329	FHIT Antibody	17kDa	Human Mouse Rat	WB IHC	200ug	59670
CLSDF6330	FCGR1A Antibody	43kDa	Human Mouse Rat	WB IHC	200ug	59670
CLSDF6331	WT1 Antibody	49kDa	Human Mouse Rat	WB IHC	200ug	59670
CLSDF6332	CD86 Antibody	38kDa	Human	WB IHC	200ug	59670
CLSDF6333	FGF10 Antibody	23kDa	Human Mouse Rat	WB IHC	200ug	59670
CLSDF6334	MMP3 Antibody	54kDa	Human Mouse Rat	WB IHC	200ug	59670
CLSDF6335	RASSF1 Antibody	39kDa	Human Mouse Rat	WB IHC	200ug	59670
CLSDF6336	LCN6 Antibody	18kDa	Human Mouse Rat	WB IHC	200ug	59670
CLSDF6337	SCRN2 Antibody	47kDa	Human Mouse Rat	WB IHC	200ug	59670
CLSDF6338	TPM3 Antibody	33kDa	Human Mouse Rat	WB IHC	200ug	59670
CLSDF6339	GSTM2 Antibody	26kDa	Human Mouse Rat	WB IHC	200ug	59670
CLSDF6340	DEFB121 Antibody	8kDa	Human	WB IHC	200ug	59670
CLSDF6341	ATP6AP1 Antibody	52kDa	Human Mouse Rat	WB IHC	200ug	59670
CLSDF6342	UGDH Antibody	55kDa	Human Mouse Rat	WB IHC	200ug	59670
CLSDF6343	ECI1 Antibody	33kDa	Human Mouse Rat	WB IHC	200ug	59670
CLSDF6344	CA3 Antibody	30kDa	Human Mouse Rat	WB IHC	200ug	59670
CLSDF6345	NET1 Antibody	68kDa	Human Mouse Rat	WB IHC	200ug	59670
CLSDF6346	ARHGDI2 Antibody	28kDa	Human Mouse Rat	WB IHC	200ug	59670
CLSDF6347	SHMT2 Antibody	55kDa	Human Mouse Rat	WB IHC	200ug	59670
CLSDF6348	BHMT Antibody	45kDa	Human Mouse Rat	WB IHC	200ug	59670
CLSDF6349	SRPX Antibody	52kDa	Human Mouse Rat	WB IHC	200ug	59670
CLSDF6350	AK1 Antibody	22kDa	Human Mouse Rat	WB IHC	200ug	59670
CLSDF6351	STIP1 Antibody	63kDa	Human Mouse Rat	WB IHC	200ug	59670
CLSDF6352	APOH Antibody	38kDa	Human Mouse Rat	WB IHC	200ug	59670
CLSDF6353	ITPA Antibody	21kDa	Human Mouse Rat	WB IHC	200ug	59670
CLSDF6354	SELENBP1 Antibody	52kDa	Human Mouse Rat	WB IHC	200ug	59670
CLSDF6355	ARHGAP25 Antibody	73kDa	Human Mouse Rat	WB IHC	200ug	59670
CLSDF6356	CST8 Antibody	16kDa	Human Mouse Rat	WB IHC	200ug	59670
CLSDF6357	GIPC2 Antibody	34kDa	Human Mouse Rat	WB IHC	200ug	59670
CLSDF6358	ALDH2 Antibody	56kDa	Human Mouse Rat	WB IHC	200ug	59670
CLSDF6359	AKR7A2 Antibody	40kDa	Human Mouse Rat	WB IHC	200ug	59670
CLSDF6360	CD55 Antibody	41kDa	Human	WB IHC	200ug	59670
CLSDF6361	PRKAA1 Antibody	63kDa	Human Mouse Rat	WB IHC	200ug	59670
CLSDF6362	IL7R Antibody	52kDa	Human Mouse Rat	WB IHC	200ug	59670
CLSDF6363	CDC20 Antibody	55kDa	Human Mouse Rat	WB IHC	200ug	59670
CLSDF6364	GYPC Antibody	14kDa	Human Mouse Rat	WB IHC	200ug	59670
CLSDF6365	KLRC1 Antibody	26kDa	Human	WB IHC	200ug	59670
CLSDF6366	PLA2G2A Antibody	16kDa	Human Mouse Rat	WB IHC	200ug	59670
CLSDF6367	SDC1 Antibody	33kDa	Human Mouse Rat	WB IHC	200ug	59670
CLSDF6368	TNFRSF10B Antibody	48kDa	Human	WB IHC	200ug	59670
CLSDF6369	TNFSF13 Antibody	27kDa	Human Mouse Rat	WB IHC	200ug	59670
CLSDF6370	CD3D Antibody	19kDa	Human Mouse Rat	WB IHC	200ug	59670
CLSDF6371	CGA Antibody	13kDa	Human Mouse Rat	WB IHC	200ug	59670
CLSDF6372	ERG Antibody	55kDa	Human Mouse Rat	WB IHC	200ug	59670
CLSDF6373	F11R Antibody	33kDa	Human Mouse Rat	WB IHC	200ug	59670
CLSDF6374	PRSS1 Antibody	27kDa	Human Mouse Rat	WB IHC	200ug	59670
CLSDF6375	ATXN3 Antibody	43kDa	Human Mouse Rat	WB IHC	200ug	59670
CLSDF6376	NFE2L2 Antibody	68kDa	Human Mouse Rat	WB IHC	200ug	59670
CLSDF6377	PSMA3 Antibody	28kDa	Human Mouse Rat	WB IHC	200ug	59670
CLSDF6378	NOD1 Antibody	108kDa	Human Mouse Rat	WB IHC	200ug	59670
CLSDF6379	EHMT2 Antibody	132kDa	Human Mouse Rat	WB IHC	200ug	59670
CLSDF6380	EIF4EBP1 Antibody	12kDa	Human Mouse Rat	WB IHC	200ug	59670
CLSDF6381	VAMP2 Antibody	18kDa	Human Mouse Rat	WB IHC	200ug	59670
CLSDF6382	JNK2 Antibody	48kDa	Human Mouse Rat	WB IHC	200ug	59670
CLSDF6383	TYR Antibody	60kDa	Human Mouse Rat	WB IHC	200ug	59670
CLSDF6384	MITF Antibody	59kDa	Human Mouse Rat	WB	200ug	59670
CLSDF6385	GSTT1 Antibody	27kDa	Human Mouse Rat	WB IHC	200ug	59670
CLSDF6386	Cyclin D1 Antibody	34kDa	Human Mouse Rat	WB IHC	200ug	59670
CLSDF6387	BDNF Antibody	28kDa	Human Mouse Rat	WB IHC	200ug	59670
CLSDF6388	HFE Antibody	40kDa	Human Mouse Rat	WB IHC	200ug	59670



Antibodies

HSN : 38220090

Cat#	Product Description	MW	Reactivity	Application	Pack Size	Unit Price
CLSDF6389	GHRL Antibody	13kDa	Human Mouse Rat	WB IHC	200ug	59670
CLSDF6390	SOD2 Antibody	25kDa	Human Mouse Rat	WB IHC	200ug	59670
CLSDF6391	HMOX1 Antibody	33kDa	Human Mouse Rat	WB IHC	200ug	59670
CLSDF6392	CD44 Antibody	82kDa	Human Mouse Rat	WB IHC	200ug	59670
CLSDF6393	MAOA Antibody	58kDa	Human Mouse Rat	WB IHC	200ug	59670
CLSDF6394	CETP Antibody	55kDa	Human	WB IHC	200ug	59670
CLSDF6395	SPP1 Antibody	33kDa	Human Mouse Rat	WB IHC	200ug	59670
CLSDF6396	ALB Antibody	69kDa	Human Mouse Rat	WB IHC	200ug	59670
CLSDF6397	F8 Antibody	267kDa/25kDa	Human Mouse Rat	WB IHC	200ug	59670
CLSDF6398	CYP17A1 Antibody	57kDa	Human Mouse Rat	WB IHC	200ug	59670
CLSDF6399	CYP1B1 Antibody	61kDa	Human Mouse Rat	WB IHC	200ug	59670
CLSDF6400	F3 Antibody	33kDa	Human	WB IHC	200ug	59670
CLSDF6401	OGG1 Antibody	39kDa	Human Mouse Rat	WB IHC	200ug	59670
CLSDF6402	FCGR2A Antibody	35kDa	Human	WB IHC	200ug	59670
CLSDF6403	MICA Antibody	43kDa	Human	WB	200ug	59670
CLSDF6404	MIF Antibody	12kDa	Human Mouse Rat	WB IHC	200ug	59670
CLSDF6405	AGER Antibody	43kDa	Human Mouse Rat	WB IHC	200ug	59670
CLSDF6406	FGB Antibody	56kDa	Human Mouse	WB IHC	200ug	59670
CLSDF6407	PTPN22 Antibody	92kDa	Human Mouse Rat	WB IHC	200ug	59670
CLSDF6408	HLA-DPB1 Antibody	29kDa	Human Mouse Rat	WB IHC	200ug	59670
CLSDF6409	TGFBR2 Antibody	65kDa	Human Mouse Rat	WB IHC	200ug	59670
CLSDF6410	CBS Antibody	61kDa	Human Mouse Rat	WB IHC	200ug	59670
CLSDF6411	LIPC Antibody	56kDa	Human Mouse Rat	WB IHC	200ug	59670
CLSDF6412	PROC Antibody	52kDa	Human Mouse Rat	WB IHC	200ug	59670
CLSDF6413	CA2 Antibody	29kDa	Human Mouse Rat	WB IHC	200ug	59670
CLSDF6414	PTPN6 Antibody	65kDa	Human Mouse Rat	WB IHC	200ug	59670
CLSDF6415	TLR3 Antibody	99kDa	Human Mouse Rat	WB IHC	200ug	59670
CLSDF6416	F10 Antibody	55kDa	Human Mouse Rat	WB IHC	200ug	59670
CLSDF6417	CXCL10 Antibody	10kDa	Human Mouse Rat	WB IHC	200ug	59670
CLSDF6418	APOBEC3G Antibody	46kDa	Human	WB IHC	200ug	59670
CLSDF6419	BCHE Antibody	68kDa	Human Mouse Rat	WB	200ug	59670
CLSDF6420	LGALS3 Antibody	26kDa	Human Mouse Rat	WB IHC	200ug	59670
CLSDF6421	CLU Antibody	53kDa	Human Mouse Rat	WB IHC	200ug	59670
CLSDF6422	FSHR Antibody	78kDa	Human Mouse Rat	WB IHC	200ug	59670
CLSDF6423	CDKN1A Antibody	21kDa	Human Mouse Rat	WB IHC	200ug	59670
CLSDF6424	NOS1 Antibody	160kDa	Human Mouse Rat	WB IHC	200ug	59670
CLSDF6425	PRDX4 Antibody	31kDa	Human Mouse Rat	WB IHC	200ug	59670
CLSDF6426	TLR8 Antibody	115kDa	Human Mouse Rat	WB IHC	200ug	59670
CLSDF6427	RBBP4 Antibody	48kDa	Human Mouse Rat	WB IHC	200ug	59670
CLSDF6428	TET1 Antibody	235kDa	Human Mouse Rat	WB IP	200ug	59670
CLSDF6429	HSP70 Antibody	70kDa	Human Mouse Rat	WB	200ug	59670
CLSDF6430	ADIPOR1 Antibody	43kDa	Human Mouse Rat	WB IHC	200ug	59670
CLSDF6431	NPY Antibody	11kDa	Human Mouse Rat	WB IHC	200ug	59670
CLSDF6432	TIMP3 Antibody	24kDa	Human Mouse Rat	WB IHC	200ug	59670
CLSDF6433	CES2 Antibody	62kDa	Human Mouse Rat	WB IHC	200ug	59670
CLSDF6434	COL5A1 Antibody	184kDa	Human Mouse Rat	WB IHC	200ug	59670
CLSDF6435	HDAC9 Antibody	111kDa	Human Mouse Rat	WB IHC	200ug	59670
CLSDF6436	IGF2BP1 Antibody	63kDa	Human Mouse Rat	WB IHC	200ug	59670
CLSDF6437	NQO1 Antibody	31kDa	Human Mouse Rat	WB IHC	200ug	59670
CLSDF6438	PICK1 Antibody	47kDa	Human Mouse Rat	WB IHC	200ug	59670
CLSDF6439	PRMT5 Antibody	73kDa	Human Mouse Rat	WB IHC	200ug	59670
CLSDF6440	UPF1 Antibody	123kDa	Human Mouse Rat	WB IHC	200ug	59670
CLSDF6441	CASP7 Antibody	151kDa	Human Mouse Rat	WB IHC	200ug	59670
CLSDF6442	AIF1 Antibody	17kDa	Human Mouse Rat	WB IHC	200ug	59670
CLSDF6443	UCP3 Antibody	34kDa	Human Mouse Rat	WB IHC	200ug	59670
CLSDF6444	G6PD Antibody	59kDa	Human Mouse Rat	WB IHC	200ug	59670
CLSDF6445	PSMC5 Antibody	46kDa	Human Mouse Rat	WB IHC	200ug	59670
CLSDF6446	NFATC1 Antibody	78kDa;101kDa	Human Mouse Rat	WB IHC	200ug	59670
CLSDF6447	TNF-R1 Antibody	50kDa	Human Mouse Rat	WB IHC	200ug	59670
CLSDF6448	CDK6 Antibody	36kDa	Human Mouse Rat	WB IHC	200ug	59670
CLSDF6449	ANG Antibody	17kDa	Human Mouse Rat	WB IHC	200ug	59670
CLSDF6450	NOS3 Antibody	133kDa	Human Mouse Rat	WB IHC	200ug	59670
CLSDF6451	CD4 Antibody	55kDa	Human	WB IHC	200ug	59670
CLSDF6452	BIRC5 Antibody	16kDa	Human Mouse Rat	WB IHC	200ug	59670
CLSDF6453	LTA Antibody	22kDa	Human Mouse Rat	WB IHC	200ug	59670
CLSDF6454	TIMP2 Antibody	24kDa	Human Mouse Rat	WB IHC	200ug	59670
CLSDF6455	PAH Antibody	52kDa	Human Mouse Rat	WB IHC	200ug	59670
CLSDF6456	COL2A1 Antibody	142kD	Human Mouse Rat	WB IHC	200ug	59670
CLSDF6457	CST3 Antibody	16kDa	Human Mouse Rat	WB IHC	200ug	59670
CLSDF6458	B2M Antibody	14kDa	Human Mouse Rat	WB IHC	200ug	59670



Antibodies

HSN : 38220090

Cat#	Product Description	MW	Reactivity	Application	Pack Size	Unit Price
CLSDF6459	NAT1 Antibody	34kDa	Human Mouse Rat	WB IHC	200ug	59670
CLSDF6460	CDK9 Antibody	43kDa	Human Mouse Rat	WB IHC	200ug	59670
CLSDF6461	BMP4 Antibody	47kDa	Human Mouse Rat	WB IHC	200ug	59670
CLSDF6462	BSG Antibody	42kDa	Human	WB IHC	200ug	59670
CLSDF6463	CHRM2 Antibody	52kDa	Human Mouse Rat	WB IHC	200ug	59670
CLSDF6464	MAOB Antibody	59kDa	Human Mouse Rat	WB IHC	200ug	59670
CLSDF6465	TPH1 Antibody	55kDa	Human Mouse Rat	WB IHC	200ug	59670
CLSDF6466	IL-6R Antibody	52kD	Human	WB IHC	200ug	59670
CLSDF6467	HP Antibody	42kDa	Human Mouse Rat	WB IHC	200ug	59670
CLSDF6468	ANXA2 Antibody	39kDa	Human Mouse Rat	WB IHC	200ug	59670
CLSDF6469	A2M Antibody	163kDa	Human	WB IHC	200ug	59670
CLSDF6470	SERPINC1 Antibody	53kDa	Human Mouse Rat	WB IHC	200ug	59670
CLSDF6471	IFNB1 Antibody	22kDa	Human	WB IHC	200ug	59670
CLSDF6472	BTK Antibody	76kDa	Human Mouse Rat	WB IHC	200ug	59670
CLSDF6473	SIN3A Antibody	145kDa	Human Mouse Rat	WB IHC	200ug	59670
CLSDF6474	F9 Antibody	59kDa	Human Mouse Rat	WB IHC	200ug	59670
CLSDF6475	HLA-DRA Antibody	29kDa	Human Mouse Rat	WB IHC	200ug	59670
CLSDF6476	ITGAM Antibody	127kDa	Human Mouse Rat	WB IHC	200ug	59670
CLSDF6477	THRB Antibody	53kDa	Human Mouse Rat	WB IHC	200ug	59670
CLSDF6478	NR1I2 Antibody	50kDa	Human Mouse Rat	WB IHC	200ug	59670
CLSDF6479	SCARB1 Antibody	61kDa	Human Mouse Rat	WB IHC	200ug	59670
CLSDF6480	REN Antibody	45kDa	Human Mouse Rat	WB IHC	200ug	59670
CLSDF6481	ABO Antibody	40kDa	Human Mouse Rat	WB IHC	200ug	59670
CLSDF6482	ADORA2A Antibody	45kDa	Human Mouse Rat	WB IHC	200ug	59670
CLSDF6483	MYOC Antibody	57kDa	Human Mouse Rat	WB IHC	200ug	59670
CLSDF6484	ADD1 Antibody	44kDa	Human Mouse Rat	WB IHC	200ug	59670
CLSDF6485	BAD Antibody	18kDa	Human Mouse Rat	WB IHC	200ug	59670
CLSDF6486	CTSD Antibody	45kDa	Human Mouse Rat	WB IHC	200ug	59670
CLSDF6487	PROS1 Antibody	70kDa	Human Mouse Rat	WB IHC	200ug	59670
CLSDF6488	ETS1 Antibody	50kDa	Human Mouse Rat	WB IHC	200ug	59670
CLSDF6489	CHRM1 Antibody	51kDa	Human Mouse Rat	WB IHC	200ug	59670
CLSDF6490	SULT1A1 Antibody	34kDa	Human Mouse Rat	WB IHC	200ug	59670
CLSDF6491	RBP4 Antibody	23kDa	Human Mouse Rat	WB IHC	200ug	59670
CLSDF6492	HAMP Antibody	9kDa	Human Mouse	WB IHC	200ug	59670
CLSDF6493	ERCC5 Antibody	133kDa	Human Mouse Rat	WB IHC	200ug	59670
CLSDF6494	MMP13 Antibody	54kDa	Human Mouse Rat	WB IHC	200ug	59670
CLSDF6495	DHFR Antibody	21kDa	Human Mouse Rat	WB IHC	200ug	59670
CLSDF6496	ELAVL1 Antibody	36kDa	Human Mouse Rat	WB IHC	200ug	59670
CLSDF6497	NPPA Antibody	17kDa	Human Mouse Rat	WB IHC	200ug	59670
CLSDF6498	TAP2 Antibody	76kDa	Human Mouse Rat	WB IHC	200ug	59670
CLSDF6499	HLA-DRB3 Antibody	30kDa	Human Mouse Rat	WB IHC	200ug	59670
CLSDF6500	MUTYH Antibody	60kDa	Human Mouse Rat	WB IHC	200ug	59670
CLSDF6501	IL23R Antibody	69kDa	Human Mouse Rat	WB IHC	200ug	59670
CLSDF6502	INDO Antibody	45kDa	Human	WB IHC	200ug	59670
CLSDF6503	SPARC Antibody	35kDa	Human Mouse Rat	WB IHC	200ug	59670
CLSDF6504	CSNK2A2 Antibody	41kDa	Human Mouse Rat	WB IHC	200ug	59670
CLSDF6505	KIR3DL1 Antibody	49kDa	Human	WB IHC	200ug	59670
CLSDF6506	PRL Antibody	26kDa	Human Mouse Rat	WB IHC	200ug	59670
CLSDF6507	DPYD Antibody	110kDa	Human Mouse Rat	WB IHC	200ug	59670
CLSDF6508	FABP2 Antibody	15kDa	Human Mouse Rat	WB IHC	200ug	59670
CLSDF6509	SELL Antibody	42kDa	Human Mouse Rat	WB IHC	200ug	59670
CLSDF6510	KPNA2 Antibody	58kDa	Human Mouse Rat	WB IHC	200ug	59670
CLSDF6511	TFPI Antibody	35kDa	Human Mouse Rat	WB IHC	200ug	59670
CLSDF6512	RFC1 Antibody	128kDa	Human Mouse Rat	WB IHC	200ug	59670
CLSDF6513	XPA Antibody	31kDa	Human Mouse Rat	WB IHC	200ug	59670
CLSDF6514	GSTA1 Antibody	26kDa	Human Mouse Rat	WB IHC	200ug	59670
CLSDF6515	IDE Antibody	118kDa	Human Mouse Rat	WB IHC	200ug	59670
CLSDF6516	S100A4 Antibody	12kDa	Human Mouse Rat	WB IHC	200ug	59670
CLSDF6517	DTNBP1 Antibody	39kDa	Human Mouse Rat	WB IHC	200ug	59670
CLSDF6518	HMGCR Antibody	95kDa	Human Mouse Rat	WB IHC	200ug	59670
CLSDF6519	RASA1 Antibody	116kDa	Human Mouse Rat	WB IHC	200ug	59670
CLSDF6520	CYBB Antibody	65kDa	Human Mouse Rat	WB IHC	200ug	59670
CLSDF6521	ETV6 Antibody	53kDa	Human Mouse Rat	WB IHC	200ug	59670
CLSDF6522	OLR1 Antibody	31kDa	Human	WB IHC	200ug	59670
CLSDF6523	CAMP Antibody	19kDa	Human	WB IHC	200ug	59670
CLSDF6524	CTNND1 Antibody	105kDa	Human Mouse Rat	WB IHC	200ug	59670
CLSDF6525	ITGAL Antibody	129kDa	Human Mouse Rat	WB IHC	200ug	59670
CLSDF6526	CD274 Antibody	33kDa	Human Mouse Rat	WB IHC	200ug	59670
CLSDF6527	PON2 Antibody	39kDa	Human Mouse Rat	WB IHC	200ug	59670
CLSDF6528	AHSG Antibody	39kDa	Human Mouse Rat	WB IHC	200ug	59670



Antibodies

HSN : 38220090

Cat#	Product Description	MW	Reactivity	Application	Pack Size	Unit Price
CLSDF6529	SFRS1 Antibody	28kDa	Human Mouse Rat	WB IHC	200ug	59670
CLSDF6530	IL7 Antibody	20kDa	Human Mouse Rat	WB IHC	200ug	59670
CLSDF6531	CD46 Antibody	43kDa	Human Mouse Rat	WB IHC	200ug	59670
CLSDF6532	PTHLH Antibody	20kDa	Human Mouse Rat	WB IHC	200ug	59670
CLSDF6533	SAA1 Antibody	14kDa	Human Mouse Rat	WB IHC	200ug	59670
CLSDF6534	BTRC Antibody	69kDa	Human Mouse Rat	WB IHC	200ug	59670
CLSDF6535	PDE4D Antibody	91kDa	Human Mouse Rat	WB IHC	200ug	59670
CLSDF6536	SELPLG Antibody	120kDa	Human	WB IHC	200ug	59670
CLSDF6537	UGT1A9 Antibody	60kDa	Human Mouse Rat	WB IHC	200ug	59670
CLSDF6538	ADRBK1 Antibody	80kDa	Human Mouse Rat	WB IHC	200ug	59670
CLSDF6539	MBP Antibody	33kDa	Human Mouse Rat	WB IHC	200ug	59670
CLSDF6540	PDPK1 Antibody	63kDa	Human Mouse Rat	WB IHC	200ug	59670
CLSDF6541	TAC1 Antibody	15kDa	Human Mouse Rat	WB IHC	200ug	59670
CLSDF6542	VTN Antibody	54kDa	Human Mouse	WB IHC	200ug	59670
CLSDF6543	DCN Antibody	30kDa	Human Mouse Rat	WB IHC	200ug	59670
CLSDF6544	KNG1 Antibody	72kDa	Human Mouse Rat	WB IHC	200ug	59670
CLSDF6545	CCL4 Antibody	10kDa	Human Mouse Rat	WB IHC	200ug	59670
CLSDF6546	CDC25C Antibody	53kDa	Human Mouse Rat	WB IHC	200ug	59670
CLSDF6547	SERPINF1 Antibody	46kDa	Human Mouse Rat	WB IHC	200ug	59670
CLSDF6548	PAX3 Antibody	50kDa	Human Mouse Rat	WB IHC	200ug	59670
CLSDF6549	SLC22A5 Antibody	63kDa	Human Mouse Rat	WB IHC	200ug	59670
CLSDF6550	XRCC4 Antibody	38kDa	Human Mouse Rat	WB IHC	200ug	59670
CLSDF6551	CD38 Antibody	34kDa	Human	WB IHC	200ug	59670
CLSDF6552	POLB Antibody	38kDa	Human Mouse Rat	WB IHC	200ug	59670
CLSDF6553	POU2F1 Antibody	76kDa	Human Mouse Rat	WB IHC	200ug	59670
CLSDF6554	AKR1B1 Antibody	36kDa	Human Mouse Rat	WB IHC	200ug	59670
CLSDF6555	MPZ Antibody	28kDa	Human Mouse Rat	WB IHC	200ug	59670
CLSDF6556	S100A8 Antibody	11kDa	Human Mouse Rat	WB IHC	200ug	59670
CLSDF6557	CD59 Antibody	19kDa	Human	WB IHC	200ug	59670
CLSDF6558	F12 Antibody	68kDa	Human Rat	WB IHC	200ug	59670
CLSDF6559	CDK7 Antibody	39kDa	Human Mouse Rat	WB IHC	200ug	59670
CLSDF6560	KIR2DL1 Antibody	39kDa	Human	WB IHC	200ug	59670
CLSDF6561	KIR2DL3 Antibody	38kDa	Human	WB IHC	200ug	59670
CLSDF6562	MAD2L1 Antibody	24kDa	Human Mouse Rat	WB IHC	200ug	59670
CLSDF6563	HNRNPK Antibody	51kDa	Human Mouse Rat	WB IHC	200ug	59670
CLSDF6564	CEACAM1 Antibody	58kDa	Human	WB IHC	200ug	59670
CLSDF6565	CD9 Antibody	25kDa	Human Mouse Rat	WB IHC	200ug	59670
CLSDF6566	WFS1 Antibody	100kDa	Human Mouse Rat	WB IHC	200ug	59670
CLSDF6567	CFB Antibody	86kDa	Human Mouse Rat	WB IHC	200ug	59670
CLSDF6568	CTBP1 Antibody	48kDa	Human Mouse Rat	WB IHC	200ug	59670
CLSDF6569	CYP11A1 Antibody	60kDa	Human Mouse Rat	WB IHC	200ug	59670
CLSDF6570	ERCC3 Antibody	89kDa	Human Mouse Rat	WB IHC	200ug	59670
CLSDF6571	IFNAR1 Antibody	63kDa	Human	WB IHC	200ug	59670
CLSDF6572	SERPING1 Antibody	55kDa	Human Mouse Rat	WB IHC	200ug	59670
CLSDF6573	DRD5 Antibody	53kDa	Human Mouse Rat	WB IHC	200ug	59670
CLSDF6574	IGFBP5 Antibody	31kDa	Human Mouse Rat	WB IHC	200ug	59670
CLSDF6575	TLR5 Antibody	98kDa	Human Mouse Rat	WB IHC	200ug	59670
CLSDF6576	COL18A1 Antibody	178kDa	Human Mouse Rat	WB IHC	200ug	59670
CLSDF6577	CHI3L1 Antibody	43kDa	Human Mouse Rat	WB IHC	200ug	59670
CLSDF6578	MED1 Antibody	168kDa	Human Mouse Rat	WB IHC	200ug	59670
CLSDF6579	PGF Antibody	24kDa	Human Mouse Rat	WB IHC	200ug	59670
CLSDF6580	ANXA5 Antibody	36kDa	Human Mouse Rat	WB IHC	200ug	59670
CLSDF6581	SCGB1A1 Antibody	10kDa	Human Mouse Rat	WB IHC	200ug	59670
CLSDF6582	HDAC6 Antibody	131kDa	Human Mouse Rat	WB IHC	200ug	59670
CLSDF6583	GABRG2 Antibody	55kDa	Human Mouse Rat	WB IHC	200ug	59670
CLSDF6584	ARSA Antibody	54kDa	Human Mouse Rat	WB IHC	200ug	59670
CLSDF6585	NR0B1 Antibody	52kDa	Human Mouse Rat	WB IHC	200ug	59670
CLSDF6586	CHRNA5 Antibody	53kDa	Human Mouse Rat	WB IHC	200ug	59670
CLSDF6587	KPNA1 Antibody	60kDa	Human Mouse Rat	WB IHC	200ug	59670
CLSDF6588	LIG4 Antibody	104kDa	Human Mouse Rat	WB IHC	200ug	59670
CLSDF6589	PTH1R Antibody	66kDa	Human Rat	WB IHC	200ug	59670
CLSDF6590	FXN Antibody	23kDa	Human Mouse Rat	WB IHC	200ug	59670
CLSDF6591	MTTP Antibody	99kDa	Human Mouse Rat	WB IHC	200ug	59670
CLSDF6592	USF1 Antibody	34kDa	Human Mouse Rat	WB IHC	200ug	59670
CLSDF6593	FCER1A Antibody	30kDa	Human	WB IHC	200ug	59670
CLSDF6594	CD3E Antibody	23kDa	Human Mouse Rat	WB IHC	200ug	59670
CLSDF6595	POLR2E Antibody	24kDa	Human Mouse Rat	WB IHC	200ug	59670
CLSDF6596	VCL Antibody	124kDa	Human Mouse Rat	WB IHC	200ug	59670
CLSDF6597	CD1D Antibody	38kDa	Human Mouse Rat	WB IHC	200ug	59670
CLSDF6598	CDH13 Antibody	78kDa	Human Mouse	WB IHC	200ug	59670

Antibodies
HSN : 38220090

Cat#	Product Description	MW	Reactivity	Application	Pack Size	Unit Price
CLSDF6599	FKBP1A Antibody	12kDa	Human Mouse Rat	WB IHC	200ug	59670
CLSDF6600	IL16 Antibody	142kDa	Human Mouse Rat	WB IHC	200ug	59670
CLSDF6601	SCNN1B Antibody	73kDa	Human Mouse Rat	WB IHC	200ug	59670
CLSDF6602	COP55 Antibody	37kDa	Human Mouse Rat	WB IHC	200ug	59670
CLSDF6603	AIRE Antibody	58kDa	Human Mouse Rat	WB IHC	200ug	59670
CLSDF6604	FTL Antibody	19kDa	Human Mouse Rat	WB IHC	200ug	59670
CLSDF6605	IFNAR2 Antibody	58kDa	Human	WB IHC	200ug	59670
CLSDF6606	PSMB9 Antibody	23kDa	Human Mouse Rat	WB IHC	200ug	59670
CLSDF6607	APOC2 Antibody	11kDa	Human Mouse Rat	WB IHC	200ug	59670
CLSDF6608	CCND2 Antibody	33kDa	Human Mouse Rat	WB IHC	200ug	59670
CLSDF6609	BUB1B Antibody	120kDa	Human Mouse Rat	WB IHC	200ug	59670
CLSDF6610	GGT1 Antibody	60kDa	Human Mouse Rat	WB IHC	200ug	59670
CLSDF6611	HMBS Antibody	39kDa	Human Mouse Rat	WB IHC	200ug	59670
CLSDF6612	MX1 Antibody	76kDa	Human Mouse Rat	WB IHC	200ug	59670
CLSDF6613	AKR1C3 Antibody	37kDa	Human Mouse Rat	WB IHC	200ug	59670
CLSDF6614	CTSK Antibody	39kDa	Human Mouse Rat	WB IHC	200ug	59670
CLSDF6615	DCTN1 Antibody	142kDa	Human Mouse Rat	WB IHC	200ug	59670
CLSDF6616	CASP6 Antibody	22kDa	Human Mouse Rat	WB IHC	200ug	59670
CLSDF6617	POLR2C Antibody	31kDa	Human Mouse Rat	WB IHC	200ug	59670
CLSDF6618	RAGE Antibody	48kDa	Human Mouse Rat	WB IHC	200ug	59670
CLSDF6619	TFF1 Antibody	9kDa	Human	WB IHC	200ug	59670
CLSDF6620	DCK Antibody	31kDa	Human Mouse Rat	WB IHC	200ug	59670
CLSDF6621	RGS2 Antibody	24kDa	Human Mouse Rat	WB IHC	200ug	59670
CLSDF6622	GADD45A Antibody	18kDa	Human Mouse Rat	WB IHC	200ug	59670
CLSDF6623	ORM1 Antibody	24kDa	Human	WB IHC	200ug	59670
CLSDF6624	XRCC2 Antibody	32kDa	Human Mouse Rat	WB IHC	200ug	59670
CLSDF6625	ALDH1A1 Antibody	55kDa	Human Mouse Rat	WB IHC	200ug	59670
CLSDF6626	GABRA2 Antibody	51kDa	Human Mouse Rat	WB IHC	200ug	59670
CLSDF6627	VIP Antibody	19kDa	Human Mouse Rat	WB IHC	200ug	59670
CLSDF6628	KLK1 Antibody	29kDa	Human Mouse Rat	WB IHC	200ug	59670
CLSDF6629	PTPN2 Antibody	49kDa	Human Mouse Rat	WB IHC	200ug	59670
CLSDF6630	SDC2 Antibody	22kDa	Human Mouse Rat	WB IHC	200ug	59670
CLSDF6631	ICOS Antibody	23kDa	Human Mouse Rat	WB IHC	200ug	59670
CLSDF6632	FANCC Antibody	63kDa	Human	WB IHC	200ug	59670
CLSDF6633	SLC22A6 Antibody	62kDa	Human Mouse Rat	WB IHC	200ug	59670
CLSDF6634	BMPR1A Antibody	60kDa	Human Mouse Rat	WB IHC	200ug	59670
CLSDF6635	EIF6 Antibody	27kDa	Human Mouse Rat	WB IHC	200ug	59670
CLSDF6636	PSAP Antibody	58kDa	Human Mouse Rat	WB IHC	200ug	59670
CLSDF6637	KEAP1 Antibody	70kDa	Human Mouse Rat	WB IHC	200ug	59670
CLSDF6638	CXADR Antibody	40kDa	Human Mouse Rat	WB IHC	200ug	59670
CLSDF6639	HSD3B2 Antibody	42kDa	Human	WB IHC	200ug	59670
CLSDF6640	THPO Antibody	38kDa	Human Mouse Rat	WB IHC	200ug	59670
CLSDF6641	GRIA1 Antibody	105kDa	Human Mouse Rat	WB IHC IF	200ug	59670
CLSDF6642	IL2RG Antibody	42kDa	Human Mouse Rat	WB IHC	200ug	59670
CLSDF6643	IL10RA Antibody	63kDa	Human	WB IHC	200ug	59670
CLSDF6644	PTBP1 Antibody	57kDa	Human Mouse Rat	WB IHC	200ug	59670
CLSDF6645	RBX1 Antibody	12kDa	Human Mouse Rat	WB IHC	200ug	59670
CLSDF6646	POLH Antibody	78kDa	Human Mouse Rat	WB IHC	200ug	59670
CLSDF6647	SFTPC Antibody	21kDa	Human Mouse Rat	WB IHC	200ug	59670
CLSDF6648	NR0B2 Antibody	28kDa	Human	WB IHC	200ug	59670
CLSDF6649	CD47 Antibody	35kDa	Human Mouse Rat	WB IHC	200ug	59670
CLSDF6650	FCER2 Antibody	36kDa	Human Mouse Rat	WB IHC	200ug	59670
CLSDF6651	HCFC1 Antibody	209kDa	Human Mouse Rat	WB IHC	200ug	59670
CLSDF6652	PRDX1 Antibody	22kDa	Human Mouse Rat	WB IHC	200ug	59670
CLSDF6653	POLR2J Antibody	13kDa	Human Mouse Rat	WB IHC	200ug	59670
CLSDF6654	RPGR Antibody	113kDa	Human Mouse Rat	WB IHC	200ug	59670
CLSDF6655	OPTN Antibody	66kDa	Human Mouse Rat	WB IHC	200ug	59670
CLSDF6656	AMBP Antibody	39kDa	Human Mouse Rat	WB IHC	200ug	59670
CLSDF6657	ARG1 Antibody	35kDa	Human Mouse Rat	WB IHC	200ug	59670
CLSDF6658	DDB2 Antibody	48kDa	Human Mouse Rat	WB IHC	200ug	59670
CLSDF6659	IKZF1 Antibody	53kDa	Human Mouse Rat	WB IHC	200ug	59670
CLSDF6660	ATF3 Antibody	20kDa	Human Mouse Rat	WB IHC	200ug	59670
CLSDF6661	CES1 Antibody	63kDa	Human Mouse Rat	WB IHC	200ug	59670
CLSDF6662	HSPA1L Antibody	70kDa	Human Mouse Rat	WB IHC	200ug	59670
CLSDF6663	LIG1 Antibody	102kDa	Human Mouse Rat	WB IHC	200ug	59670
CLSDF6664	POLR2D Antibody	16kDa	Human Mouse Rat	WB IHC	200ug	59670
CLSDF6665	AREG Antibody	28kDa	Human Mouse Rat	WB IHC	200ug	59670
CLSDF6666	DKC1 Antibody	58kDa	Human Mouse Rat	WB IHC	200ug	59670
CLSDF6667	GLB1 Antibody	76kDa	Human Mouse Rat	WB IHC	200ug	59670
CLSDF6668	POLR2I Antibody	15kDa	Human Mouse Rat	WB IHC	200ug	59670



Antibodies

HSN : 38220090

Cat#	Product Description	MW	Reactivity	Application	Pack Size	Unit Price
CLSDF6669	LY96 Antibody	18kDa	Human Rat	WB IHC	200ug	59670
CLSDF6670	ACADM Antibody	46kDa	Human Mouse Rat	WB IHC	200ug	59670
CLSDF6671	GABRB2 Antibody	59kDa	Human Mouse Rat	WB IHC	200ug	59670
CLSDF6672	IL24 Antibody	24kDa	Human Mouse Rat	WB IHC	200ug	59670
CLSDF6673	ABCG8 Antibody	76kDa	Human Mouse Rat	WB IHC	200ug	59670
CLSDF6674	SLC25A4 Antibody	33kDa	Human Mouse Rat	WB IHC	200ug	59670
CLSDF6675	C1QBP Antibody	31kDa	Human Mouse Rat	WB IHC	200ug	59670
CLSDF6676	EPXH2 Antibody	62kDa	Human Mouse Rat	WB IHC	200ug	59670
CLSDF6677	LIG3 Antibody	113kDa	Human Mouse Rat	WB IHC	200ug	59670
CLSDF6678	RAD9A Antibody	42kDa	Human Mouse Rat	WB IHC	200ug	59670
CLSDF6679	CADM1 Antibody	49kDa	Human Mouse	WB IHC	200ug	59670
CLSDF6680	PDHA1 Antibody	43kDa	Human Mouse Rat	WB IHC	200ug	59670
CLSDF6681	CCL21 Antibody	15kDa	Human Mouse Rat	WB IHC	200ug	59670
CLSDF6682	IL1R2 Antibody	45kDa	Human	WB IHC	200ug	59670
CLSDF6683	FMO3 Antibody	60kDa	Human Mouse Rat	WB IHC	200ug	59670
CLSDF6684	RUVBL2 Antibody	51kDa	Human Mouse Rat	WB IHC	200ug	59670
CLSDF6685	PADI4 Antibody	74kDa	Human	WB IHC	200ug	59670
CLSDF6686	HOXA9 Antibody	30kDa	Human Mouse Rat	WB IHC	200ug	59670
CLSDF6687	LMNB1 Antibody	66kDa	Human Mouse Rat	WB IHC	200ug	59670
CLSDF6688	PPP2R4 Antibody	40kDa	Human Mouse Rat	WB IHC	200ug	59670
CLSDF6689	CNTF Antibody	23kDa	Human Mouse Rat	WB IHC	200ug	59670
CLSDF6690	MNAT1 Antibody	36kDa	Human Mouse Rat	WB IHC	200ug	59670
CLSDF6691	PRDX2 Antibody	22kDa	Human Mouse Rat	WB IHC	200ug	59670
CLSDF6692	UMOD Antibody	70kDa	Human Mouse Rat	WB IHC	200ug	59670
CLSDF6693	DLC1 Antibody	171kDa	Human Mouse	WB IHC	200ug	59670
CLSDF6694	MSR1 Antibody	50kDa	Human Mouse Rat	WB IHC	200ug	59670
CLSDF6695	PPBP Antibody	14kDa	Human Mouse Rat	WB IHC	200ug	59670
CLSDF6696	TFAM Antibody	29kDa	Human	WB IHC	200ug	59670
CLSDF6697	TNNC1 Antibody	18kDa	Human Mouse Rat	WB IHC	200ug	59670
CLSDF6698	BUB1 Antibody	122kDa	Human Mouse Rat	WB IHC	200ug	59670
CLSDF6699	CD151 Antibody	28kDa	Human Mouse Rat	WB IHC	200ug	59670
CLSDF6700	GLO1 Antibody	21kDa	Human Mouse Rat	WB IHC	200ug	59670
CLSDF6701	GPX4 Antibody	22kDa	Human Mouse Rat	WB IHC	200ug	59670
CLSDF6702	RAB27A Antibody	24kDa	Human Mouse Rat	WB IHC	200ug	59670
CLSDF6703	EBAG9 Antibody	24kDa	Human Mouse Rat	WB IHC	200ug	59670
CLSDF6704	U2AF2 Antibody	53kDa	Human Mouse Rat	WB IHC	200ug	59670
CLSDF6705	ACPP Antibody	48kDa	Human Mouse Rat	WB IHC	200ug	59670
CLSDF6706	GRIK2 Antibody	103kDa	Human Mouse Rat	WB IHC	200ug	59670
CLSDF6707	POLI Antibody	80kDa	Human Mouse Rat	WB IHC	200ug	59670
CLSDF6708	APBB1 Antibody	77kDa	Human Mouse Rat	WB IHC	200ug	59670
CLSDF6709	CD27 Antibody	50kDa	Human Mouse Rat	WB IHC	200ug	59670
CLSDF6710	GPC3 Antibody	66kDa	Human Mouse Rat	WB IHC	200ug	59670
CLSDF6711	SMAD5 Antibody	52kDa	Human Mouse Rat	WB IHC	200ug	59670
CLSDF6712	ODC1 Antibody	51kDa	Human Mouse Rat	WB IHC	200ug	59670
CLSDF6713	PSMD10 Antibody	24kDa	Human Mouse Rat	WB IHC	200ug	59670
CLSDF6714	TCP1 Antibody	60kDa	Human Mouse Rat	WB IHC	200ug	59670
CLSDF6715	UBE2D1 Antibody	17kDa	Human Mouse Rat	WB IHC	200ug	59670
CLSDF6716	MCM6 Antibody	93kDa	Human Mouse Rat	WB IHC	200ug	59670
CLSDF6717	TRIM21 Antibody	54kDa	Human Mouse Rat	WB IHC	200ug	59670
CLSDF6718	HIST2H2BE Antibody	14kDa	Human	WB IHC	200ug	59670
CLSDF6719	LAMP2 Antibody	45kDa	Human Mouse Rat	WB IHC	200ug	59670
CLSDF6720	MSMB Antibody	13kDa	Human	WB IHC	200ug	59670
CLSDF6721	NDP Antibody	15kDa	Human Mouse Rat	WB IHC	200ug	59670
CLSDF6722	PGK1 Antibody	45kDa	Human Mouse Rat	WB IHC	200ug	59670
CLSDF6723	TAPBP Antibody	47kDa	Human	WB IHC	200ug	59670
CLSDF6724	TNFRSF14 Antibody	30kDa	Human	WB IHC	200ug	59670
CLSDF6725	NR1I3 Antibody	39kDa	Human	WB IHC	200ug	59670
CLSDF6726	PLCB1 Antibody	139kDa	Human Mouse Rat	WB IHC	200ug	59670
CLSDF6727	KCNN4 Antibody	47kDa	Human Mouse Rat	WB IHC	200ug	59670
CLSDF6728	PSMB5 Antibody	28kDa	Human Mouse Rat	WB IHC	200ug	59670
CLSDF6729	PTPRA Antibody	90kDa	Human Mouse Rat	WB IHC	200ug	59670
CLSDF6730	RPL5 Antibody	34kDa	Human Mouse Rat	WB IHC	200ug	59670
CLSDF6731	TFF3 Antibody	8kDa	Human	WB IHC	200ug	59670
CLSDF6732	MVP Antibody	99kDa	Human Mouse Rat	WB IHC	200ug	59670
CLSDF6733	ACVR2A Antibody	57kDa	Human Mouse Rat	WB IHC	200ug	59670
CLSDF6734	HSD17B2 Antibody	42kDa	Human	WB IHC	200ug	59670
CLSDF6735	IPO5 Antibody	123kDa	Human Mouse Rat	WB IHC	200ug	59670
CLSDF6736	PSMC2 Antibody	48kDa	Human Mouse Rat	WB IHC	200ug	59670
CLSDF6737	PSMC3 Antibody	49kDa	Human Mouse Rat	WB IHC	200ug	59670
CLSDF6738	S100A10 Antibody	11kDa	Human Mouse Rat	WB IHC	200ug	59670



Antibodies

HSN : 38220090

Cat#	Product Description	MW	Reactivity	Application	Pack Size	Unit Price
CLSDF6739	TBXAS1 Antibody	61kDa	Human Mouse Rat	WB IHC	200ug	59670
CLSDF6740	OGT Antibody	117kDa	Human Mouse Rat	WB IHC	200ug	59670
CLSDF6741	CD244 Antibody	41kDa	Human	WB IHC	200ug	59670
CLSDF6742	APCS Antibody	25kDa	Human Mouse Rat	WB IHC	200ug	59670
CLSDF6743	PSMD2 Antibody	100kDa	Human Mouse Rat	WB IHC	200ug	59670
CLSDF6744	SMARCA5 Antibody	122kDa	Human Mouse Rat	WB IHC	200ug	59670
CLSDF6745	AOC3 Antibody	84kDa	Human Mouse Rat	WB IHC	200ug	59670
CLSDF6746	POSTN Antibody	93kDa	Human Mouse Rat	WB IHC	200ug	59670
CLSDF6747	PTP4A3 Antibody	19kDa	Human Mouse Rat	WB IHC	200ug	59670
CLSDF6748	BMPR1B Antibody	57kDa	Human Mouse	WB IHC	200ug	59670
CLSDF6749	CDA Antibody	16kDa	Human Mouse Rat	WB IHC	200ug	59670
CLSDF6750	IFI16 Antibody	88kDa	Human	WB IHC	200ug	59670
CLSDF6751	ANGPTL4 Antibody	45kDa	Human Mouse Rat	WB IHC	200ug	59670
CLSDF6752	DST Antibody	861kDa	Human Mouse Rat	WB IHC	200ug	59670
CLSDF6753	CBLB Antibody	109kDa	Human Mouse Rat	WB IHC	200ug	59670
CLSDF6754	EIF5A Antibody	16kDa	Human Mouse Rat	WB IHC	200ug	59670
CLSDF6755	MT2A Antibody	7kDa	Human Mouse Rat	WB IHC	200ug	59670
CLSDF6756	RPS19 Antibody	16kDa	Human Mouse Rat	WB IHC	200ug	59670
CLSDF6757	TAF9 Antibody	20kDa	Human Mouse Rat	WB IHC	200ug	59670
CLSDF6758	TPSAB1 Antibody	31kDa	Human Mouse Rat	WB IHC	200ug	59670
CLSDF6759	WDR5 Antibody	36kDa	Human Mouse Rat	WB IHC	200ug	59670
CLSDF6760	KPNA4 Antibody	57kDa	Human Mouse Rat	WB IHC	200ug	59670
CLSDF6761	RPS27A Antibody	9kDa	Human Mouse Rat	WB IHC	200ug	59670
CLSDF6762	CD99 Antibody	28kDa	Human	WB IHC	200ug	59670
CLSDF6763	NT5E Antibody	63kDa	Human Mouse Rat	WB IHC	200ug	59670
CLSDF6764	EXT1 Antibody	86kDa	Human Mouse Rat	WB IHC	200ug	59670
CLSDF6765	PRDX6 Antibody	25kDa	Human Mouse Rat	WB IHC	200ug	59670
CLSDF6766	CD70 Antibody	21kDa	Human Mouse Rat	WB IHC	200ug	59670
CLSDF6767	CD79B Antibody	35kDa	Human Mouse Rat	WB IHC	200ug	59670
CLSDF6768	CSF2RA Antibody	47kDa	Human	WB IHC	200ug	59670
CLSDF6769	CLDN7 Antibody	24kDa	Human Mouse Rat	WB IHC	200ug	59670
CLSDF6770	PCK1 Antibody	69kDa	Human Mouse Rat	WB IHC	200ug	59670
CLSDF6771	PVRL1 Antibody	57kDa	Human Mouse Rat	WB IHC	200ug	59670
CLSDF6772	ICAM2 Antibody	31kDa	Human	WB IHC	200ug	59670
CLSDF6773	KLRD1 Antibody	20kDa	Human Mouse Rat	WB IHC	200ug	59670
CLSDF6774	CD83 Antibody	23kDa	Human Mouse Rat	WB IHC	200ug	59670
CLSDF6775	ADH5 Antibody	40kDa	Human Mouse Rat	WB IHC	200ug	59670
CLSDF6776	SLAMF1 Antibody	70kDa	Human	WB IHC	200ug	59670
CLSDF6777	CD69 Antibody	20kDa	Human Mouse Rat	WB IHC	200ug	59670
CLSDF6778	LHX8 Antibody	43kDa	Human Mouse Rat	WB IHC	200ug	59670
CLSDF6779	cdc45 Antibody	64kDa	Human Mouse Rat	WB IHC	200ug	59670
CLSDF6780	ADRBK2 Antibody	80kDa	Human Mouse Rat	WB IHC	200ug	59670
CLSDF6781	AK4 Antibody	25kDa	Human Mouse Rat	WB IHC	200ug	59670
CLSDF6782	KLK3 Antibody	29kDa	Human	WB IHC	200ug	59670
CLSDF6783	AR Antibody	110kDa	Human Mouse Rat	WB IHC	200ug	59670
CLSDF6784	CAPZA2 Antibody	33kDa	Human Mouse Rat	WB IHC	200ug	59670
CLSDF6785	RUNX1 Antibody	51kDa	Human Mouse Rat	WB IHC	200ug	59670
CLSDF6786	CCNB1 Antibody	48kDa	Human Mouse Rat	WB IHC	200ug	59670
CLSDF6787	CCNT1 Antibody	81kDa	Human Mouse Rat	WB IHC	200ug	59670
CLSDF6788	CD247 Antibody	16kDa	Human Mouse Rat	WB IHC	200ug	59670
CLSDF6789	CD33 Antibody	40kDa	Human	WB IHC	200ug	59670
CLSDF6790	CDKN1C Antibody	32kDa	Human Mouse Rat	WB IHC	200ug	59670
CLSDF6791	CDKN3 Antibody	24kDa	Human Mouse Rat	WB IHC	200ug	59670
CLSDF6792	CHUK Antibody	85kDa	Human	WB IHC	200ug	59670
CLSDF6793	CTLA4 Antibody	25kDa	Human	WB IHC	200ug	59670
CLSDF6794	CTNNB1 Antibody	86kDa	Human Mouse Rat	WB IHC	200ug	59670
CLSDF6795	DNMT3A Antibody	102kDa	Human Mouse Rat	WB IHC	200ug	59670
CLSDF6796	TOR1A Antibody	38kDa	Human Mouse Rat	WB IHC	200ug	59670
CLSDF6797	E2F1 Antibody	47kDa	Human Mouse Rat	WB IHC	200ug	59670
CLSDF6798	EEF2 Antibody	95kDa	Human Mouse Rat	WB IHC	200ug	59670
CLSDF6799	EPHX1 Antibody	53kDa	Human Mouse Rat	WB IHC	200ug	59670
CLSDF6800	FANCD2 Antibody	166kDa	Human Mouse Rat	WB IHC	200ug	59670
CLSDF6801	FGFR1 Antibody	91kDa	Human Mouse Rat	WB IHC	200ug	59670
CLSDF6802	FGFR2 Antibody	79kDa	Human Mouse Rat	WB IHC	200ug	59670
CLSDF6803	FGR Antibody	56kDa	Human	WB IHC	200ug	59670
CLSDF6804	XRCC6 Antibody	75kDa	Human Mouse Rat	WB IHC	200ug	59670
CLSDF6805	GNA15 Antibody	44kDa	Human Mouse Rat	WB IHC	200ug	59670
CLSDF6806	GSK3B Antibody	48kDa	Human Mouse Rat	WB IHC	200ug	59670
CLSDF6807	HCK Antibody	57kDa	Human Mouse Rat	WB IHC	200ug	59670
CLSDF6808	HDAC2 Antibody	55kDa	Human Mouse Rat	WB IHC	200ug	59670



Antibodies

HSN : 38220090

Cat#	Product Description	MW	Reactivity	Application	Pack Size	Unit Price
CLSDF6809	HNF4A Antibody	52kDa	Human Mouse Rat	WB IHC	200ug	59670
CLSDF6810	IGF2 Antibody	20kDa	Human Mouse Rat	WB IHC	200ug	59670
CLSDF6811	IKKBK Antibody	81kDa	Human Mouse Rat	WB IHC	200ug	59670
CLSDF6812	IL1RN Antibody	20kDa	Human Mouse Rat	WB IHC	200ug	59670
CLSDF6813	IL13 Antibody	16kDa	Human Mouse Rat	WB IHC	200ug	59670
CLSDF6814	INS Antibody	12kDa	Human Mouse Rat	WB IHC	200ug	59670
CLSDF6815	ITGAV Antibody	115kDa	Human Mouse Rat	WB IHC	200ug	59670
CLSDF6816	LCN2 Antibody	23kDa	Human Mouse Rat	WB IHC	200ug	59670
CLSDF6817	LYN Antibody	59kDa	Human Mouse Rat	WB IHC	200ug	59670
CLSDF6818	MKI67 Antibody	359kDa	Human	WB IHC	200ug	59670
CLSDF6819	MMP9 Antibody	78kDa	Human Mouse Rat	WB IHC	200ug	59670
CLSDF6820	NCF4 Antibody	39kDa	Human Mouse Rat	WB IHC	200ug	59670
CLSDF6821	NGFR Antibody	45kDa	Human Mouse Rat	WB IHC	200ug	59670
CLSDF6822	NTRK1 Antibody	145kDa	Human Mouse Rat	WB IHC	200ug	59670
CLSDF6823	NTRK2 Antibody	90kDa	Human Mouse Rat	WB IHC	200ug	59670
CLSDF6824	TNFRSF11B Antibody	46kDa	Human Mouse Rat	WB IHC	200ug	59670
CLSDF6825	REG3A Antibody	19kDa	Human Mouse Rat	WB IHC	200ug	59670
CLSDF6826	PDE1B Antibody	61kDa	Human Mouse Rat	WB IHC	200ug	59670
CLSDF6827	PDGFRA Antibody	123kDa	Human Mouse Rat	WB IHC	200ug	59670
CLSDF6828	CD31 Antibody	83kDa	Human	WB IHC	200ug	59670
CLSDF6829	PGR Antibody	99kDa	Human Mouse Rat	WB IHC	200ug	59670
CLSDF6830	PIN1 Antibody	18kDa	Human Mouse Rat	WB IHC	200ug	59670
CLSDF6831	POLR2A Antibody	270kDa	Human Mouse Rat	WB IHC	200ug	59670
CLSDF6832	PPA1 Antibody	33kDa	Human Mouse Rat	WB IHC	200ug	59670
CLSDF6833	PPP4C Antibody	35kDa	Human Mouse Rat	WB IHC	200ug	59670
CLSDF6834	PRKCE Antibody	84kDa	Human Mouse Rat	WB IHC	200ug	59670
CLSDF6835	MAPK7 Antibody	89kDa	Human Mouse Rat	WB IHC	200ug	59670
CLSDF6836	MAPK10 Antibody	36kDa	Human Mouse Rat	WB IHC	200ug	59670
CLSDF6837	PTEN Antibody	47kDa	Human Mouse Rat	WB IHC	200ug	59670
CLSDF6838	PTK2 Antibody	119kDa	Human Mouse Rat	WB IHC	200ug	59670
CLSDF6839	PTPRC Antibody	147kDa	Human Mouse Rat	WB IHC	200ug	59670
CLSDF6840	RB1 Antibody	110kDa	Human Mouse Rat	WB IHC	200ug	59670
CLSDF6841	SMARCA4 Antibody	185kDa	Human Mouse Rat	WB IHC	200ug	59670
CLSDF6842	SORD Antibody	38kDa	Human Mouse Rat	WB IHC	200ug	59670
CLSDF6843	UAP1 Antibody	57kDa	Human Mouse Rat	WB IHC	200ug	59670
CLSDF6844	SPAM1 Antibody	58kDa	Human Mouse Rat	WB IHC	200ug	59670
CLSDF6845	AURKA Antibody	46kDa	Human	WB IHC	200ug	59670
CLSDF6846	STK11 Antibody	49kDa	Human Mouse Rat	WB IHC	200ug	59670
CLSDF6847	SYK Antibody	72kDa	Human Mouse Rat	WB IHC	200ug	59670
CLSDF6848	THBS1 Antibody	129kDa	Human Mouse Rat	WB IHC	200ug	59670
CLSDF6849	THY1 Antibody	18kDa	Human Mouse Rat	WB IHC	200ug	59670
CLSDF6850	TNFAIP3 Antibody	90kDa	Human Mouse Rat	WB IHC	200ug	59670
CLSDF6851	TYK2 Antibody	134kDa	Human Mouse Rat	WB IHC	200ug	59670
CLSDF6852	UBB Antibody	26kDa	Human Mouse Rat	WB IHC	200ug	59670
CLSDF6853	SUMO1 Antibody	12kDa	Human Mouse	WB IHC	200ug	59670
CLSDF6854	UCHL1 Antibody	25kDa	Human Mouse Rat	WB IHC	200ug	59670
CLSDF6855	VEGFB Antibody	19kDa	Human Mouse Rat	WB IHC	200ug	59670
CLSDF6856	Wnt5a Antibody	42kDa	Human Mouse Rat	WB IHC	200ug	59670
CLSDF6857	XRCC3 Antibody	38kDa	Human Mouse	WB IHC	200ug	59670
CLSDF6858	ZYX Antibody	80kDa	Human Mouse Rat	WB IHC	200ug	59670
CLSDF6859	CUL1 Antibody	90kDa	Human Mouse Rat	WB IHC	200ug	59670
CLSDF6860	TP63 Antibody	77kDa	Human Mouse Rat	WB IHC	200ug	59670
CLSDF6861	TNFSF10 Antibody	33kDa	Human	WB IHC	200ug	59670
CLSDF6862	HDAC3 Antibody	49kDa	Human Mouse Rat	WB IHC	200ug	59670
CLSDF6863	NUMBL Antibody	65kDa	Human Mouse Rat	WB IHC	200ug	59670
CLSDF6864	NR1H3 Antibody	50kDa	Human Mouse Rat	WB IHC	200ug	59670
CLSDF6865	NDRG1 Antibody	43kDa	Human Mouse Rat	WB IHC	200ug	59670
CLSDF6866	GAS2L1 Antibody	73kDa	Human Mouse Rat	WB IHC	200ug	59670
CLSDF6867	MALT1 Antibody	92kDa	Human Mouse Rat	WB IHC	200ug	59670
CLSDF6868	CHEK2 Antibody	61kDa	Human Mouse Rat	WB IHC	200ug	59670
CLSDF6869	REG3G Antibody	19kDa	Human Mouse Rat	WB IHC	200ug	59670
CLSDF6870	LETMD1 Antibody	42kDa	Human Mouse Rat	WB IHC	200ug	59670
CLSDF6871	SCCPDH Antibody	47kDa	Human Mouse Rat	WB IHC	200ug	59670
CLSDF6872	SPINLW1 Antibody	15kDa	Human Mouse Rat	WB IHC	200ug	59670
CLSDF6873	MIWI Antibody	99kDa	Mouse Rat	WB IHC IF IP	200ug	59670
CLSDF6874	ELSPBP1 Antibody	26kDa	Human	WB IHC	200ug	59670
CLSDF6875	KBTBD3 Antibody	67kDa	Human Mouse Rat	WB IHC	200ug	59670
CLSDF6876	SPDYA Antibody	36kDa	Human Mouse Rat	WB IHC	200ug	59670
CLSDF6877	SCN4B Antibody	25kDa	Human Mouse Rat	WB IHC	200ug	59670
CLSDF6878	ATF2 Antibody	56kDa	Human Mouse Rat	WB IHC	200ug	59670



Antibodies

HSN : 38220090

Cat#	Product Description	MW	Reactivity	Application	Pack Size	Unit Price
CLSDF6879	CASP3 Antibody	17kDa;19kDa;35kDa	Human Mouse Rat	WB IP	200ug	59670
CLSDF6880	MAX Antibody	18kDa	Human Mouse Rat	WB IHC	200ug	59670
CLSDF6881	ALOX5 Antibody	78kDa	Human Mouse Rat	WB IHC	200ug	59670
CLSDF6882	CYP1A1 Antibody	58kDa	Human Mouse Rat	WB IHC	200ug	59670
CLSDF6883	CYP2E1 Antibody	57kDa	Human Mouse Rat	WB IHC	200ug	59670
CLSDF6884	CYP19A1 Antibody	58kDa	Human Mouse Rat	WB IHC	200ug	59670
CLSDF6885	EIF4E Antibody	29kDa	Human Mouse Rat	WB IHC	200ug	59670
CLSDF6886	GJA1 Antibody	43kDa	Human Mouse Rat	WB IHC	200ug	59670
CLSDF6887	NR3C1 Antibody	86kDa	Human Mouse Rat	WB IHC	200ug	59670
CLSDF6888	HCLS1 Antibody	54kDa	Human Mouse Rat	WB IHC	200ug	59670
CLSDF6889	CFH Antibody	49kDa	Human Mouse Rat	WB IHC	200ug	59670
CLSDF6890	HLA-A Antibody	41kDa	Human Mouse Rat	WB IHC	200ug	59670
CLSDF6891	HLA-DQA1 Antibody	28kDa	Human Mouse Rat	WB IHC	200ug	59670
CLSDF6892	IDH1 Antibody	47kDa	Human Mouse Rat	WB IHC	200ug	59670
CLSDF6893	IL1A Antibody	31kDa	Human Mouse Rat	WB IHC	200ug	59670
CLSDF6894	IL10 Antibody	19kDa	Human Mouse Rat	WB IHC	200ug	59670
CLSDF6895	IRF3 Antibody	49kDa	Human Mouse Rat	WB IHC	200ug	59670
CLSDF6896	ITGB2 Antibody	85kDa	Human Mouse Rat	WB IHC	200ug	59670
CLSDF6897	KCNQ1 Antibody	61kDa	Human Mouse Rat	WB IHC	200ug	59670
CLSDF6898	KRT17 Antibody	48kDa	Human Mouse Rat	WB IHC	200ug	59670
CLSDF6899	STMN1 Antibody	18kDa	Human Mouse Rat	WB IHC	200ug	59670
CLSDF6900	LCK Antibody	56kDa	Human Mouse Rat	WB IHC	200ug	59670
CLSDF6901	MSN Antibody	68kDa	Human Mouse Rat	WB IHC	200ug	59670
CLSDF6902	NPPB Antibody	15kDa	Human	WB IHC	200ug	59670
CLSDF6903	PDGFRB Antibody	124kDa	Human Mouse Rat	WB IHC	200ug	59670
CLSDF6904	PLAU Antibody	49kDa	Human Mouse Rat	WB IHC	200ug	59670
CLSDF6905	PLCG2 Antibody	150kDa	Human Mouse Rat	WB IHC	200ug	59670
CLSDF6906	PMS1 Antibody	106kDa	Human Rat	WB IHC	200ug	59670
CLSDF6907	PPP1CA Antibody	38kDa	Human Mouse Rat	WB IHC	200ug	59670
CLSDF6908	PPP2R2A Antibody	52kDa	Human Mouse Rat	WB IHC	200ug	59670
CLSDF6909	MAP2K7 Antibody	47kDa	Human Mouse Rat	WB IHC	200ug	59670
CLSDF6910	PSEN1 Antibody	53kDa	Human Mouse Rat	WB IHC	200ug	59670
CLSDF6911	PSMA6 Antibody	27kDa	Human Mouse Rat	WB IHC	200ug	59670
CLSDF6912	RPA2 Antibody	29kDa	Human Mouse Rat	WB IHC	200ug	59670
CLSDF6913	RPS6KB1 Antibody	59kDa	Human Mouse Rat	WB IHC	200ug	59670
CLSDF6914	SELE Antibody	67kDa	Human Mouse Rat	WB IHC	200ug	59670
CLSDF6915	TBP Antibody	38kDa	Human Mouse Rat	WB IHC	200ug	59670
CLSDF6916	UBE2I Antibody	18kDa	Human Mouse Rat	WB IHC	200ug	59670
CLSDF6917	VDR Antibody	48kDa	Human Mouse Rat	WB IHC	200ug	59670
CLSDF6918	ZAP70 Antibody	70kDa	Human Mouse Rat	WB IHC	200ug	59670
CLSDF6919	CLDN1 Antibody	23kDa	Human Mouse Rat	WB IHC	200ug	59670
CLSDF6920	DLGAP5 Antibody	95kDa	Human	WB IHC	200ug	59670
CLSDF6921	ABCC4 Antibody	97kDa	Human Mouse Rat	WB IHC	200ug	59670
CLSDF6922	RAPGEF3 Antibody	99kDa	Human Mouse Rat	WB IHC	200ug	59670
CLSDF6923	DCTN2 Antibody	44kDa	Human Mouse Rat	WB IHC	200ug	59670
CLSDF6924	NOX4 Antibody	67kDa	Human Mouse Rat	WB IHC	200ug	59670
CLSDF6925	TOLLIP Antibody	30kDa	Human Mouse Rat	WB IHC	200ug	59670
CLSDF6926	IFIH1 Antibody	117kDa	Human Mouse Rat	WB IHC	200ug	59670
CLSDF6927	PATE3 Antibody	12kDa	Human Mouse Rat	WB IHC	200ug	59670
CLSDF6928	DNMT3L Antibody	44kDa	Human Mouse	WB IHC IF IP CHIP	200ug	59670
CLSDF6929	UHRF1 Antibody	91kDa	Human	WB IHC IF IP CHIP	200ug	59670
CLSDF6930	UHRF2 Antibody	90kDa	Human	WB IHC IF	200ug	59670
CLSDF6931	USP7 Antibody	130kDa	Human Mouse Rat	WB IHC IF	200ug	59670
CLSDF6932	Histone H3 Antibody	15kDa	Human Mouse Rat OtHumaneRat (Wide Ratange)	WB IHC IF IP CHIP	200ug	59670
CLSDF6933	Histone H3K4me1 Antibody	15kDa	Human Mouse RatOtHumaneRat (Wide Ratange)	WB IHC IF	200ug	59670
CLSDF6934	Histone H3K4me2 Antibody	15kDa	Human Mouse RatOtHumaneRat (Wide Ratange)	WB IHC IF IP CHIP	200ug	59670
CLSDF6935	Histone H3K4me3 Antibody	15kDa	Human Mouse RatOtHumaneRat (Wide Ratange)	WB IHC IF IP CHIP	200ug	59670
CLSDF6936	Histone H3K9me1 Antibody	15kDa	Human Mouse RatOtHumaneRat (Wide Ratange)	WB IHC IF IP CHIP	200ug	59670
CLSDF6937	Histone H3K9me2 Antibody	15kDa	Human Mouse RatOtHumaneRat (Wide Ratange)	WB IHC IF IP CHIP	200ug	59670

Antibodies
HSN : 38220090

Cat#	Product Description	MW	Reactivity	Application	Pack Size	Unit Price
CLSDF6938	H3K9me3 Antibody	15kDa	Human Mouse Rat OtHumaneRat (Wide Ratange)	WB IHC IF IP CHIP CHIPseq	200ug	59670
CLSDF6939	Histone H3K27me1 Antibody	15kDa	Human Mouse RatOtHumaneRat (Wide Ratange)	WB IHC IF	200ug	59670
CLSDF6940	Histone H3K27me2 Antibody	15kDa	Human Mouse RatOtHumaneRat (Wide Ratange)	WB IHC IF IP	200ug	59670
CLSDF6941	Histone H3K27me3 Antibody	15kDa	Human Mouse RatOtHumaneRat (Wide Ratange)	WB IHC IF IP ChIP	200ug	59670
CLSDF6942	Histone H3K36me1 Antibody	15kDa	Human Mouse RatOtHumaneRat (Wide Ratange)	WB IF	200ug	59670
CLSDF6943	Histone H3K36me2 Antibody	15kDa	EukaRatyotes	WB IHC IF	200ug	59670
CLSDF6944	Histone H3K36me3 Antibody	15kDa	Human Mouse Rat OtHumaneRat (Wide Ratange)	WB IF ChIP	200ug	59670
CLSDF6945	Histone H3K79me1 Antibody	15kDa	Human Mouse RatOtHumaneRat (Wide Ratange)	WB IHC IF IP ChIP	200ug	59670
CLSDF6946	Histone H3K79me2 Antibody	16kDa	Human Mouse RatOtHumaneRat (Wide Ratange)	WB IHC IF IPChIP	200ug	59670
CLSDF6947	Histone H3K79me3 Antibody	15kDa	Human Mouse RatOtHumaneRat (Wide Ratange)	WB IHC IF IP ChIP	200ug	59670
CLSDF6948	Histone H4K20me1 Antibody	11kDa	Human Mouse RatOtHumaneRat (Wide Ratange)	WB	200ug	59670
CLSDF6949	HIST2H4A Antibody	11kDa	Human Mouse Rat OtHumaneRat (Wide Ratange)	WB IF IP CHIP	200ug	59670
CLSDF6950	Histone H4K20me3 Antibody	11kDa	Human Mouse RatOtHumaneRat (Wide Ratange)	WB	200ug	59670
CLSDF6951	Histone H3R2me2s Antibody	15kDa	Human Mouse RatOtHumaneRat (Wide Ratange)	WB IF IP	200ug	59670
CLSDF6952	Histone H3R8me2s Antibody	15kDa	Human Mouse RatOtHumaneRat (Wide Ratange)	WB IF IP	200ug	59670
CLSDF6953	Histone H3R26me2a Antibody	15kDa	Human Mouse Rat OtHumaneRat (Wide Ratange)	WB IF IP CHIP	200ug	59670
CLSDF6954	Histone H4R3me2a Antibody	11kDa	Human Mouse Rat OtHumaneRat (Wide Ratange)	WB IF IP ChIP	200ug	59670
CLSDF6955	Histone H3R17me2a Antibody	15kDa	Human Mouse Rat OtHumaneRat(Wide Ratange)	WB IF IP ChIP	200ug	59670
CLSDF6956	P2RY6 Antibody	36kDa	Human	WB IHC	200ug	59670
CLSDF6957	HSPA8 Antibody	70kDa	Human Mouse Rat	WB IHC	200ug	59670
CLSDF6958	BIK Antibody	18kDa	Human	WB IHC	200ug	59670
CLSDF6959	EPB41 Antibody	97kDa	Human Mouse Rat	WB IHC	200ug	59670
CLSDF6960	POLR2L Antibody	7kDa	Human Mouse Rat	WB IHC	200ug	59670
CLSDF6961	AP2M1 Antibody	49kDa	Human Mouse Rat	WB IHC	200ug	59670
CLSDF6962	FOXM1 Antibody	83kDa	Human Mouse Rat	WB IHC	200ug	59670
CLSDF6963	SIAH1 Antibody	31kDa	Human Mouse Rat	WB IHC	200ug	59670
CLSDF6964	CHAT Antibody	82kDa	Human Mouse Rat	WB IHC	200ug	59670
CLSDF6965	ILF3 Antibody	95kDa	Human Mouse Rat	WB IHC	200ug	59670
CLSDF6966	ITGB5 Antibody	88kDa	Human Mouse Rat	WB IHC	200ug	59670
CLSDF6967	RIPK2 Antibody	61kDa	Human Mouse Rat	WB IHC	200ug	59670
CLSDF6968	NUP62 Antibody	53kDa	Human Mouse Rat	WB IHC	200ug	59670
CLSDF6969	TTK Antibody	97kDa	Human Mouse Rat	WB IHC	200ug	59670
CLSDF6970	CASK Antibody	105kDa	Human Mouse Rat	WB IHC	200ug	59670
CLSDF6971	LTA4H Antibody	69kDa	Human Mouse Rat	WB IHC	200ug	59670
CLSDF6972	PSMA2 Antibody	25kDa	Human Mouse Rat	WB IHC	200ug	59670
CLSDF6973	PSMC4 Antibody	47kDa	Human Mouse Rat	WB IHC	200ug	59670
CLSDF6974	EEF1D Antibody	31kDa	Human Mouse Rat	WB IHC	200ug	59670
CLSDF6975	GNAO1 Antibody	40kDa	Human Mouse Rat	WB IHC	200ug	59670
CLSDF6976	PSMA4 Antibody	29kDa	Human Mouse Rat	WB IHC	200ug	59670
CLSDF6977	TCOF1 Antibody	152kDa	Human	WB IHC	200ug	59670
CLSDF6978	AXIN2 Antibody	93kDa	Human Mouse Rat	WB IHC	200ug	59670
CLSDF6979	HAVCR2 Antibody	33kDa	Human	WB IHC	200ug	59670
CLSDF6980	SERPINH1 Antibody	46kDa	Human Mouse Rat	WB IHC	200ug	59670
CLSDF6981	EFNB1 Antibody	38kDa	Human Mouse Rat	WB IHC	200ug	59670
CLSDF6982	HNMT Antibody	33kDa	Human Mouse Rat	WB IHC	200ug	59670
CLSDF6983	NEDD9 Antibody	92kDa	Human Mouse Rat	WB IHC	200ug	59670
CLSDF6984	PSMA1 Antibody	29kDa	Human Mouse Rat	WB IHC	200ug	59670



Antibodies

HSN : 38220090

Cat#	Product Description	MW	Reactivity	Application	Pack Size	Unit Price
CLSDF6985	SNCG Antibody	13kDa	Human Mouse Rat	WB IHC	200ug	59670
CLSDF6986	ADAMTS4 Antibody	90kDa	Human Mouse Rat	WB IHC	200ug	59670
CLSDF6987	TNK2 Antibody	114kDa	Human Mouse Rat	WB IHC	200ug	59670
CLSDF6988	DKK3 Antibody	38kDa	Human Mouse Rat	WB IHC	200ug	59670
CLSDF6989	ACP5 Antibody	37kDa	Human Mouse Rat	WB IHC	200ug	59670
CLSDF6990	GJA4 Antibody	37kDa	Human Mouse Rat	WB IHC	200ug	59670
CLSDF6991	PCBP2 Antibody	39kDa	Human Mouse Rat	WB IHC	200ug	59670
CLSDF6992	PRG2 Antibody	25kDa	Human	WB IHC	200ug	59670
CLSDF6993	RPS3 Antibody	26kDa	Human Mouse Rat	WB IHC	200ug	59670
CLSDF6994	TMPO Antibody	75kDa	Human Mouse Rat	WB IHC	200ug	59670
CLSDF6995	GRM3 Antibody	98kDa	Human Mouse Rat	WB IHC	200ug	59670
CLSDF6996	ARHGEF2 Antibody	111kDa	Human Mouse Rat	WB IHC	200ug	59670
CLSDF6997	HMMR Antibody	84kDa	Human Mouse Rat	WB IHC	200ug	59670
CLSDF6998	IL8 Antibody	11kDa	Human Mouse Rat	WB IHC	200ug	59670
CLSDF6999	ITGB3 Antibody	87kDa	Human Mouse Rat	WB IHC	200ug	59670
CLSDF7000	ADIPOQ Antibody	28kDa	Human Mouse Rat	WB IHC	200ug	59670
CLSDF7001	CYP3A4 Antibody	57kD	Human Mouse Rat	WB IHC	200ug	59670
CLSDF7002	TLR2 Antibody	90kDa	Human Mouse Rat	WB IHC	200ug	59670
CLSDF7003	p65 Antibody	65kDa	Human Mouse Rat	WB IHC	200ug	59670
CLSDF7004	PLK1 Antibody	68kDa	Human Mouse Rat	WB IHC	200ug	59670
CLSDF7005	MMP14 Antibody	65kDa	Human Mouse Rat	WB IHC	200ug	59670
CLSDF7006	TNFSF11 Antibody	35kDa	Human Mouse Rat	WB IHC	200ug	59670
CLSDF7007	FCGR3A Antibody	29kDa	Human	WB IHC	200ug	59670
CLSDF7008	HMGB1 Antibody	25kDa	Human Mouse Rat	WB IHC	200ug	59670
CLSDF7009	PAK1 Antibody	62kDa	Human Mouse Rat	WB IHC	200ug	59670
CLSDF7010	CFLAR Antibody	52kDa	Human Mouse Rat	WB IHC	200ug	59670
CLSDF7011	VEGFC Antibody	46kDa	Human Mouse Rat	WB IHC	200ug	59670
CLSDF7012	GZMB Antibody	27kDa	Human	WB IHC	200ug	59670
CLSDF7013	MRE11A Antibody	80kDa	Human Mouse Rat	WB IHC	200ug	59670
CLSDF7014	GNB2L1 Antibody	35kDa	Human Mouse Rat	WB IHC	200ug	59670
CLSDF7015	TGFBI Antibody	68kDa	Human Mouse Rat	WB IHC	200ug	59670
CLSDF7016	YWHAQ Antibody	28kDa	Human Mouse Rat	WB IF	200ug	59670
CLSDF7017	DIABLO Antibody	27kDa	Human Mouse Rat	WB IHC	200ug	59670
CLSDF7018	PRKG1 Antibody	76kDa	Human Mouse Rat	WB IHC	200ug	59670
CLSDF7019	SKP1 Antibody	18kDa	Human Mouse Rat	WB IHC	200ug	59670
CLSDF7020	LCP2 Antibody	60kDa	Human Mouse Rat	WB IHC	200ug	59670
CLSDF7021	AIFM1 Antibody	66kDa	Human Mouse Rat	WB IHC	200ug	59670
CLSDF7022	WNK1 Antibody	250kDa	Human Mouse Rat	WB IHC	200ug	59670
CLSDF7023	PDCD4 Antibody	52kDa	Human Mouse Rat	WB IHC	200ug	59670
CLSDF7024	SUMO2 Antibody	11kDa	Human Mouse Rat	WB IHC	200ug	59670
CLSDF7025	MAP2 Antibody	59kDa	Human Mouse Rat	WB IHC	200ug	59670
CLSDF7026	TBK1 Antibody	84kDa	Human Mouse Rat	WB IHC	200ug	59670
CLSDF7027	KRT7 Antibody	51kDa	Human Mouse Rat	WB IHC	200ug	59670
CLSDF7028	MAP2K6 Antibody	37kD	Human Mouse Rat	WB IHC	200ug	59670
CLSDF7029	WASL Antibody	54kDa	Human Mouse Rat	WB IHC	200ug	59670
CLSDF7030	CD19 Antibody	61kDa	Human	WB IHC	200ug	59670
CLSDF7031	FES Antibody	93kDa	Human Mouse Rat	WB IHC	200ug	59670
CLSDF7032	NRP2 Antibody	104kDa	Human Mouse Rat	WB IHC	200ug	59670
CLSDF7033	LAMP1 Antibody	45kDa	Human Mouse Rat	WB IHC	200ug	59670
CLSDF7034	PRNP Antibody	27kDa	Human Mouse Rat	WB IHC	200ug	59670
CLSDF7035	VIM Antibody	54kDa	Human Mouse Rat	WB IHC	200ug	59670
CLSDF7036	MEF2C Antibody	51kDa	Human Mouse Rat	WB IHC	200ug	59670
CLSDF7037	DRP1 Antibody	79kDa	Human Mouse Rat	WB IHC	200ug	59670
CLSDF7038	BTC Antibody	20kDa	Human Mouse Rat	WB IHC	200ug	59670
CLSDF7039	GEACAM3 Antibody	27kDa	Human	WB IHC	200ug	59670
CLSDF7040	MUSK Antibody	97kDa	Human Mouse Rat	WB IHC	200ug	59670
CLSDF7041	NDUFS1 Antibody	79kDa	Human Mouse Rat	WB IHC	200ug	59670
CLSDF7042	CLDN11 Antibody	22kDa	Human Mouse Rat	WB IHC	200ug	59670
CLSDF7043	SDHA Antibody	72kDa	Human Mouse Rat	WB IHC	200ug	59670
CLSDF7044	ALDH4A1 Antibody	62kDa	Human Mouse Rat	WB IHC	200ug	59670
CLSDF7045	CCL28 Antibody	14kDa	Human Mouse Rat	WB IHC	200ug	59670
CLSDF7046	NRG4 Antibody	12kDa	Human Mouse Rat	WB IHC	200ug	59670
CLSDF7047	APLP1 Antibody	72kD	Human Mouse Rat	WB IHC	200ug	59670
CLSDF7048	CASP9 Antibody	46kDa	Human Mouse Rat	WB	200ug	59670
CLSDF7049	KRT15 Antibody	49kDa	Human Mouse Rat	WB	200ug	59670
CLSDF7050	KRT4 Antibody	57kDa	Human Mouse Rat	WB IHC	200ug	59670
CLSDF7051	KRT5 Antibody	62kDa	Human Mouse Rat	WB	200ug	59670
CLSDF7052	VIM Antibody	54kDa	Human Mouse Rat	WB	200ug	59670
CLSDF7053	CA4 Antibody	35kDa	Human Mouse Rat	WB	200ug	59670
CLSDF7054	CTSE Antibody	43kDa	Human Mouse Rat	WB IHC	200ug	59670



Antibodies

HSN : 38220090

Cat#	Product Description	MW	Reactivity	Application	Pack Size	Unit Price
CLSDF7055	CCL24 Antibody	13kDa	Human Mouse Rat	WB	200ug	59670
CLSDF7056	CDK20 Antibody	31kDa	Human Mouse Rat	WB IHC	200ug	59670
CLSDF7057	CLEC4D Antibody	25kDa	Human Mouse Rat	WB IHC	200ug	59670
CLSDF7058	CNTFR Antibody	41kDa	Human Mouse Rat	WB IHC	200ug	59670
CLSDF7059	IL18R1 Antibody	62kDa	Human Mouse Rat	WB IHC	200ug	59670
CLSDF7060	DBH Antibody	69kDa	Human Mouse Rat	WB	200ug	59670
CLSDF7061	CLEC4A Antibody	28kDa	Human Mouse Rat	WB IHC	200ug	59670
CLSDF7062	DLK1 Antibody	41kDa	Human Mouse Rat	WB	200ug	59670
CLSDF7063	EGF Antibody	134kDa	Human Mouse Rat	WB IHC	200ug	59670
CLSDF7064	ELN Antibody	69kDa	Human Mouse Rat	WB	200ug	59670
CLSDF7065	FABP7 Antibody	15kDa	Human Mouse Rat	WB IHC	200ug	59670
CLSDF7066	FOSL2 Antibody	35kDa	Human Mouse Rat	WB	200ug	59670
CLSDF7067	GNA11 Antibody	42kDa	Human Mouse Rat	WB IHC	200ug	59670
CLSDF7068	GNAS Antibody	46kDa	Human Mouse Rat	WB	200ug	59670
CLSDF7069	GDF9 Antibody	51kDa	Human Mouse Rat	WB IHC	200ug	59670
CLSDF7070	CFHR1 Antibody	38kDa	Human Mouse Rat	WB IHC	200ug	59670
CLSDF7071	HMOX2 Antibody	36kDa	Human Mouse Rat	WB	200ug	59670
CLSDF7072	HSF2 Antibody	60kDa	Human Mouse Rat	WB	200ug	59670
CLSDF7073	TRAP1 Antibody	80kDa	Human Mouse Rat	WB IHC	200ug	59670
CLSDF7074	IMMT Antibody	84kDa	Human Mouse Rat	WB IHC	200ug	59670
CLSDF7075	FBX032 Antibody	25kDa	Human Mouse Rat	WB IHC	200ug	59670
CLSDF7076	NAP1L1 Antibody	45kDa	Human Mouse Rat	WB IHC	200ug	59670
CLSDF7077	NEUROG3 Antibody	23kDa	Human Mouse Rat	WB IHC	200ug	59670
CLSDF7078	PAK4 Antibody	64kD	Human Mouse Rat	WB IHC	200ug	59670
CLSDF7079	CDH23 Antibody	45kD	Human Mouse Rat	WB IHC	200ug	59670
CLSDF7080	PDCD10 Antibody	25kDa	Human Mouse Rat	WB IHC	200ug	59670
CLSDF7081	PGC Antibody	42kDa	Human Mouse Rat	WB IHC	200ug	59670
CLSDF7082	PSMD3 Antibody	61kDa	Human Mouse Rat	WB IHC	200ug	59670
CLSDF7083	PVALB Antibody	12kDa	Human Mouse Rat	WB	200ug	59670
CLSDF7084	PTPN11 Antibody	68kDa	Human Mouse Rat	WB IHC	200ug	59670
CLSDF7085	VCP Antibody	71kDa	Human Mouse Rat	WB IHC	200ug	59670
CLSDF7086	USO1 Antibody	108kDa	Human Mouse Rat	WB IHC	200ug	59670
CLSDF7087	SLC18A2 Antibody	55kDa	Human Mouse Rat	WB IHC	200ug	59670
CLSDF7088	BCL2 Antibody	22kDa	Human Mouse Rat	WB	200ug	59670
CLSDF7089	CPT2 Antibody	74kDa	Human Mouse Rat	WB IHC	200ug	59670
CLSDF7090	SKI Antibody	80kDa	Human Mouse Rat	WB	200ug	59670
CLSDF7091	CTGF Antibody	38kDa	Human Mouse Rat	WB IHC	200ug	59670
CLSDF7092	CUL4A Antibody	88kDa	Human Mouse Rat	WB IHC	200ug	59670
CLSDF7093	GJC2 Antibody	47kDa	Human Mouse Rat	WB	200ug	59670
CLSDF7094	AQP0 Antibody	28kDa	Human Mouse Rat	WB	200ug	59670
CLSDF7095	CXCR2 Antibody	41kDa	Human Mouse Rat	WB	200ug	59670
CLSDF7096	CX3CR1 Antibody	44kDa	Human Mouse Rat	WB	200ug	59670
CLSDF7097	DRD1 Antibody	49kDa	Human Mouse Rat	WB IHC	200ug	59670
CLSDF7098	DRD4 Antibody	48kDa	Human Mouse Rat	WB IHC	200ug	59670
CLSDF7099	LAMP3 Antibody	44kDa	Human Mouse Rat	WB IHC	200ug	59670
CLSDF7100	DBB1 Antibody	127kDa	Human Mouse Rat	WB IHC	200ug	59670
CLSDF7101	EIF4G2 Antibody	102kDa	Human Mouse Rat	WB IHC	200ug	59670
CLSDF7102	DNMT3B Antibody	96kDa	Human Mouse Rat	WB	200ug	59670
CLSDF7103	EDA Antibody	49kDa	Human Mouse Rat	WB	200ug	59670
CLSDF7104	EDNRB Antibody	50kDa	Human Mouse Rat	WB IHC	200ug	59670
CLSDF7105	EGFR Antibody	134kD	Human Mouse Rat	WB	200ug	59670
CLSDF7106	ENPP7 Antibody	52kDa	Human Mouse Rat	WB IHC	200ug	59670
CLSDF7107	PTGER2 Antibody	40kDa	Human Mouse Rat	WB	200ug	59670
CLSDF7108	EPOR Antibody	55kDa	Human Mouse Rat	WB	200ug	59670
CLSDF7109	DUSP1 Antibody	39kDa	Human Mouse Rat	WB	200ug	59670
CLSDF7110	FOXO1 Antibody	70kDa	Human Mouse Rat	WB IHC	200ug	59670
CLSDF7111	FST Antibody	38kDa	Human Mouse Rat	WB	200ug	59670
CLSDF7112	GAD1 Antibody	67kDa	Human Mouse Rat	WB	200ug	59670
CLSDF7113	CXCR3 Antibody	46kDa	Human Mouse Rat	WB IHC	200ug	59670
CLSDF7114	GRPR Antibody	43kDa	Human Mouse Rat	WB IHC	200ug	59670
CLSDF7115	CLDN3 Antibody	23kDa	Human Mouse Rat	WB IHC	200ug	59670
CLSDF7116	GJB3 Antibody	31kDa	Human Mouse Rat	WB IHC	200ug	59670
CLSDF7117	GSN Antibody	90kDa	Human Mouse Rat	WB IHC	200ug	59670
CLSDF7118	GLRA1 Antibody	53kDa	Human Mouse Rat	WB IHC	200ug	59670
CLSDF7119	UTS2R Antibody	42kDa	Human Mouse Rat	WB	200ug	59670
CLSDF7120	GRM1 Antibody	132kDa	Human Mouse Rat	WB IHC	200ug	59670
CLSDF7121	GRM8 Antibody	102kDa	Human Mouse Rat	WB IHC	200ug	59670
CLSDF7122	GRK1 Antibody	63.5kDa	Human Mouse Rat	WB IHC	200ug	59670
CLSDF7123	KISS1R Antibody	43kDa	Human Mouse Rat	WB IHC	200ug	59670
CLSDF7124	KCNH2 Antibody	90kDa	Human Mouse Rat	WB	200ug	59670

Antibodies
HSN : 38220090

Cat#	Product Description	MW	Reactivity	Application	Pack Size	Unit Price
CLSD7125	HCN1 Antibody	99kDa	Human Mouse Rat	WB IHC	200ug	59670
CLSD7126	HMGA2 Antibody	12kDa	Human Mouse Rat	WB	200ug	59670
CLSD7127	HMGB2 Antibody	24kDa	Human Mouse Rat	WB	200ug	59670
CLSD7128	HOXC8 Antibody	28kDa	Human Mouse Rat	WB IHC	200ug	59670
CLSD7129	TERT Antibody	120kDa	Human Mouse Rat	WB IHC	200ug	59670
CLSD7130	IGFBP1 Antibody	28kDa	Human Mouse Rat	WB IHC	200ug	59670
CLSD7131	IGFBP7 Antibody	29kDa	Human Mouse Rat	WB IHC	200ug	59670
CLSD7132	IL2RA Antibody	31kDa	Human Mouse Rat	WB	200ug	59670
CLSD7133	KISS1 Antibody	15kDa	Human Mouse Rat	WB IHC	200ug	59670
CLSD7134	BRAF Antibody	84kDa	Human Mouse Rat	WB IHC	200ug	59670
CLSD7135	KLF5 Antibody	51kDa	Human Mouse Rat	WB	200ug	59670
CLSD7136	KLK2 Antibody	29kDa	Human Mouse Rat	WB IHC	200ug	59670
CLSD7137	KLK5 Antibody	32kDa	Human Mouse Rat	WB IHC	200ug	59670
CLSD7138	KCNA1 Antibody	56kDa	Human Mouse Rat	WB IHC	200ug	59670
CLSD7139	LEPR Antibody	96kDa	Human Mouse Rat	WB IHC	200ug	59670
CLSD7140	LHB Antibody	15kD	Human Mouse Rat	WB	200ug	59670
CLSD7141	LRPAP1 Antibody	41kDa	Human Mouse Rat	WB IHC	200ug	59670
CLSD7142	MC2R Antibody	34kDa	Human Mouse Rat	WB	200ug	59670
CLSD7143	MC5R Antibody	37kD	Human Mouse Rat	WB	200ug	59670
CLSD7144	SLC16A1 Antibody	54kDa	Human Mouse Rat	WB IHC	200ug	59670
CLSD7145	SLC16A4 Antibody	54kDa	Human Mouse Rat	WB IHC	200ug	59670
CLSD7146	MCM4 Antibody	97kDa	Human Mouse Rat	WB IHC	200ug	59670
CLSD7147	CSF1R Antibody	108kDa	Human Mouse Rat	WB	200ug	59670
CLSD7148	ABCC1 Antibody	173kDa	Human Mouse Rat	WB IHC	200ug	59670
CLSD7149	ABCC5 Antibody	161kDa	Human Mouse Rat	WB IHC	200ug	59670
CLSD7150	MMP8 Antibody	53kDa	Human Mouse Rat	WB IHC	200ug	59670
CLSD7151	MMP25 Antibody	63kDa	Human Mouse Rat	WB IHC	200ug	59670
CLSD7152	MMP10 Antibody	54kDa	Human Mouse Rat	WB	200ug	59670
CLSD7153	MMP11 Antibody	55kDa	Human Mouse Rat	WB IHC	200ug	59670
CLSD7154	POMC Antibody	29kDa	Human Mouse Rat	WB	200ug	59670
CLSD7155	MYL9 Antibody	14kD	Human Mouse Rat	WB IHC	200ug	59670
CLSD7156	YWHAG Antibody	28kDa	Human Mouse Rat	WB IHC	200ug	59670
CLSD7157	CDH1 Antibody	135kDa	Human Mouse Rat	WB IHC	200ug	59670
CLSD7158	CDH2 Antibody	100kDa	Human Mouse Rat	WB	200ug	59670
CLSD7159	NPHS1 Antibody	135kDa	Human Mouse Rat	WB IHC	200ug	59670
CLSD7160	NFASC Antibody	150kDa	Human Mouse Rat	WB IHC	200ug	59670
CLSD7161	NTSR1 Antibody	46kDa	Human Mouse Rat	WB	200ug	59670
CLSD7162	HCRTR2 Antibody	51kDa	Human Mouse Rat	WB	200ug	59670
CLSD7163	P2RY4 Antibody	41kDa	Human Mouse Rat	WB IHC	200ug	59670
CLSD7164	P2RY11 Antibody	40kDa	Human Mouse Rat	WB IHC	200ug	59670
CLSD7165	PAWR Antibody	37kDa	Human Mouse Rat	WB IHC	200ug	59670
CLSD7166	PAR6A Antibody	37kDa	Human Mouse Rat	WB IHC	200ug	59670
CLSD7167	PXN Antibody	66kDa	Human Mouse Rat	WB IHC	200ug	59670
CLSD7168	PAX2 Antibody	45kDa	Human Mouse Rat	WB	200ug	59670
CLSD7169	PDK4 Antibody	46kDa	Human Mouse Rat	WB IHC	200ug	59670
CLSD7170	PDX1 Antibody	31kDa	Human Mouse Rat	WB IHC	200ug	59670
CLSD7171	PIBF1 Antibody	90kDa	Human Mouse Rat	WB IHC	200ug	59670
CLSD7172	PIWIL2 Antibody	110kDa	Human Mouse Rat	WB IHC	200ug	59670
CLSD7173	RAMP2 Antibody	20kD	Human Mouse Rat	WB	200ug	59670
CLSD7174	PRDX3 Antibody	28kDa	Human Mouse Rat	WB IHC	200ug	59670
CLSD7175	RAD52 Antibody	46kDa	Human Mouse Rat	WB IHC	200ug	59670
CLSD7176	RAD50 Antibody	154kDa	Human Mouse Rat	WB IHC	200ug	59670
CLSD7177	GEMIN2 Antibody	32kDa	Human Mouse Rat	WB IHC	200ug	59670
CLSD7178	SLC1A4 Antibody	56kDa	Human Mouse Rat	WB IHC	200ug	59670
CLSD7179	TCF7 Antibody	42kDa	Human Mouse Rat	WB	200ug	59670
CLSD7180	HNF1A Antibody	56kDa	Human Mouse Rat	WB	200ug	59670
CLSD7181	TRAF3 Antibody	64kDa	Human Mouse Rat	WB IHC	200ug	59670
CLSD7182	TRAF7 Antibody	67kD	Human Mouse Rat	WB IHC	200ug	59670
CLSD7183	TPM2 Antibody	33kD	Human Mouse Rat	WB IHC	200ug	59670
CLSD7184	NKX2-1 Antibody	42kDa	Human Mouse Rat	WB	200ug	59670
CLSD7185	SUMO3 Antibody	12kDa	Human Mouse Rat	WB IHC	200ug	59670
CLSD7186	SUMO4 Antibody	12kDa	Human Mouse Rat	WB IHC	200ug	59670
CLSD7187	TRIM63 Antibody	40kDa	Human Mouse Rat	WB IHC	200ug	59670
CLSD7188	MYSM1 Antibody	95kD	Human Mouse Rat	WB IHC	200ug	59670
CLSD7189	NFATC2 Antibody	98kDa	Human Mouse Rat	WB	200ug	59670
CLSD7190	NFKB2 Antibody	97kDa	Human Mouse Rat	WB	200ug	59670
CLSD7191	INA Antibody	55kDa	Human Mouse Rat	WB IHC	200ug	59670
CLSD7192	NEUROG1 Antibody	26kDa	Human Mouse Rat	WB IHC	200ug	59670
CLSD7193	NOTCH3 Antibody	244kDa	Human Mouse Rat	WB IHC	200ug	59670
CLSD7194	NPY1R Antibody	44kDa	Human Mouse Rat	WB IHC	200ug	59670



Antibodies

HSN : 38220090

Cat#	Product Description	MW	Reactivity	Application	Pack Size	Unit Price
CLSDF7195	ENO2 Antibody	47kDa	Human Mouse Rat	WB	200ug	59670
CLSDF7196	SLC22A8 Antibody	60kDa	Human Mouse Rat	WB IHC	200ug	59670
CLSDF7197	ADCYAP1R1 Antibody	53kDa	Human Mouse Rat	WB IHC	200ug	59670
CLSDF7198	PARP1 Antibody	113kDa	Human Mouse Rat	WB IHC	200ug	59670
CLSDF7199	PPP2CB Antibody	36kDa	Human Mouse Rat	WB IHC	200ug	59670
CLSDF7200	PTN Antibody	19kDa	Human Mouse Rat	WB	200ug	59670
CLSDF7201	SCTR Antibody	50kDa	Human Mouse Rat	WB IHC	200ug	59670
CLSDF7202	SLC5A1 Antibody	60kDa	Human Mouse Rat	WB	200ug	59670
CLSDF7203	SLC32A1 Antibody	57kDa	Human Mouse Rat	WB IHC	200ug	59670
CLSDF7204	SFTPA1 Antibody	28kDa	Human Mouse Rat	WB	200ug	59670
CLSDF7205	SSTR1 Antibody	43kDa	Human Mouse Rat	WB IHC	200ug	59670
CLSDF7206	SSTR2 Antibody	41kDa	Human Mouse Rat	WB IHC	200ug	59670
CLSDF7207	PIWIL4 Antibody	97kDa	Human Mouse Rat	WB	200ug	59670
CLSDF7208	pan-AKT Antibody	56kDa	Human Mouse Rat	WB	200ug	59670
CLSDF7217	AIF1 Antibody	17kDa	Human Mouse Rat	WB IHC	200ug	59670
CLSDF7218	APP Antibody	87kDa	Human Mouse Rat	WB IHC	200ug	59670
CLSDF7219	ARF6 Antibody	20kDa	Human Mouse Rat	WB IHC	200ug	59670
CLSDF7220	Histone H3R26me1 Antibody	15kDa	Human Mouse RatOtHumaneRat (Wide Ratange)	WBIHC IF	200ug	59670
CLSDF7221	CASP3 Antibody	32kDa	Human Mouse Rat	WB IHC	200ug	59670
CLSDF7222	CDK6 Antibody	37kDa	Human Mouse Rat	WB IHC	200ug	59670
CLSDF7223	CHI3L1 Antibody	43kD	Human Mouse Rat	WB IHC	200ug	59670
CLSDF7224	CSF2RA Antibody	46kDa	Human Mouse Rat	WB	200ug	59670
CLSDF7225	CUL3 Antibody	89kDa	Human Mouse Rat	WB IHC	200ug	59670
CLSDF7226	DNMT3A Antibody	78kDa	Human Mouse Rat	WB IHC	200ug	59670
CLSDF7227	DRD5 Antibody	53kDa	Human Mouse Rat	WB IHC	200ug	59670
CLSDF7228	DUSP6 Antibody	27kDa	Human Mouse Rat	WB IHC	200ug	59670
CLSDF7229	FSHR Antibody	71kDa	Human Mouse Rat	WB IHC	200ug	59670
CLSDF7230	GNAZ Antibody	41kDa	Human Mouse Rat	WB IHC	200ug	59670
CLSDF7231	GSK3B Antibody	48kDa	Human Mouse Rat	WB	200ug	59670
CLSDF7232	LCN2 Antibody	23kDa	Human Mouse Rat	WB IHC	200ug	59670
CLSDF7233	MSH6 Antibody	153kDa	Human Mouse Rat	WB IHC	200ug	59670
CLSDF7234	NPY Antibody	11kDa	Human Mouse Rat	WB IHC	200ug	59670
CLSDF7235	NTF3 Antibody	31kDa	Human Mouse Rat	WB IHC	200ug	59670
CLSDF7236	NTF4 Antibody	22kDa	Human Mouse Rat	WB IHC	200ug	59670
CLSDF7237	PECAM1 Antibody	83kDa	Human Mouse Rat	WB IHC	200ug	59670
CLSDF7238	TP53 Antibody	44kDa	Human Mouse Rat	WB	200ug	59670
CLSDF7239	TTR Antibody	16kDa	Human Mouse Rat	WB IHC	200ug	59670
CLSDF7240	TUBA4A Antibody	50kDa	Human Mouse Rat	WB IHC	200ug	59670
CLSDF7241	RAD23A Antibody	39kDa	Human Mouse Rat	WB IHC	200ug	59670
CLSDF7242	PELP1 Antibody	119kDa	Human Mouse Rat	WB IHC	200ug	59670
CLSDF7243	NLK Antibody	58kDa	Human Mouse Rat	WB IHC	200ug	59670
CLSDF7244	Abca6 Antibody	183kDa	Human Mouse Rat	WB IHC	200ug	59670
CLSDF7245	FAM160B2 Antibody	82kDa	Human Mouse Rat	WB IHC	200ug	59670
CLSDF7246	SETD2 Antibody	28kDa	Human Mouse Rat	WB IHC	200ug	59670
CLSDF7247	PAK1 Antibody	61kDa	Human Mouse Rat	WB IHC	200ug	59670
CLSDF7248	RRM2 Antibody	45kDa	Human Mouse Rat	WB IHC	200ug	59670
CLSDF7249	SETD8 Antibody	43kDa	Human Mouse Rat	WB IHC	200ug	59670
CLSDF7250	FOXP1 Antibody	75kDa	Human	WB IHC	200ug	59670
CLSDF7251	H3K14me1 Antibody	15kDa	Human Mouse Rat	WB IHCIF	200ug	59670
CLSDF7252	H3K14me2 Antibody	15kDa	Human Mouse Rat	WB IHCIF	200ug	59670
CLSDF7253	H3K14me3 Antibody	15kDa	Human Mouse Rat	WB IHCIF	200ug	59670
CLSDF7254	Nono Antibody	54kDa	Human Mouse Rat	WB IHC	200ug	59670
CLSDF7255	ERCC1 Antibody	33kDa	Human Mouse Rat	WB IHC	200ug	59670
CLSDF7256	EIF4A1 Antibody	46kDa	Human Mouse Rat	WB IHC	200ug	59670
CLSDF7257	CHRN1 Antibody	57kDa	Human Mouse Rat	WB IHC	200ug	59670
CLSDF7258	DDX5 Antibody	69kDa	Human Mouse Rat	WB IHC	200ug	59670
CLSDF7259	RACGAP1 Antibody	71kDa	Human Mouse Rat	WB IHC	200ug	59670
CLSDF7260	AHCY Antibody	48kDa	Human Mouse Rat	WB IHC	200ug	59670
CLSDF7261	AIMP1 Antibody	34kDa	Human Mouse Rat	WB IHC ICC IP FC	200ug	59670
CLSDF7262	ATL1 Antibody	63kDa	Human Mouse Rat	WB IHC	200ug	59670
CLSDF7263	C10orf2 Antibody	77kDa	Human Mouse Rat	WB IHC	200ug	59670
CLSDF7264	CHRNA1 Antibody	31kDa	Human Mouse Rat	WB IHC	200ug	59670
CLSDF7265	CUL2 Antibody	87kDa	Human Mouse Rat	WB IHC	200ug	59670
CLSDF7266	DAO Antibody	39kDa	Human Mouse Rat	WB IHC	200ug	59670
CLSDF7267	FABP1 Antibody	14kDa	Human Mouse Rat	WB IHC	200ug	59670
CLSDF7268	GCLM Antibody	30kDa	Human Mouse Rat	WB IHC	200ug	59670
CLSDF7269	GLRX Antibody	12kDa	Human Mouse Rat	WB IHC	200ug	59670
CLSDF7270	GMNN Antibody	23kDa	Human Mouse Rat	WB IHC	200ug	59670



Antibodies

HSN : 38220090

Cat#	Product Description	MW	Reactivity	Application	Pack Size	Unit Price
CLSDF7271	KLKB1 Antibody	71kDa	Human Mouse Rat	WB IHC	200ug	59670
CLSDF7272	NDRG2 Antibody	41kDa	Human Mouse Rat	WB IHC	200ug	59670
CLSDF7273	PDZK1 Antibody	57kDa	Human Mouse Rat	WB IHC	200ug	59670
CLSDF7274	POLD1 Antibody	123kDa	Human Mouse Rat	WB IHC	200ug	59670
CLSDF7275	PRKACB Antibody	40kDa	Human Mouse Rat	WB IHC	200ug	59670
CLSDF7276	PTGES3 Antibody	19kDa	Human Mouse Rat	WB IHC	200ug	59670
CLSDF7277	S100A12 Antibody	10kDa	Human	WB IHC	200ug	59670
CLSDF7278	SERPINE2 Antibody	44kDa	Human Mouse Rat	WB IHC	200ug	59670
CLSDF7279	SGCE Antibody	50kDa	Human Mouse Rat	WB IHC	200ug	59670
CLSDF7280	SLC4A4 Antibody	121kDa	Human Mouse Rat	WB IHC	200ug	59670
CLSDF7281	UTS2 Antibody	14kDa	Human	WB IHC	200ug	59670
CLSDF7282	BPI Antibody	54kDa	Human	WB IHC	200ug	59670
CLSDF7283	C1QB Antibody	26kDa	Human Mouse Rat	WB IHC	200ug	59670
CLSDF7284	EFNA1 Antibody	24kDa	Human Mouse Rat	WB IHC	200ug	59670
CLSDF7285	GHRH Antibody	12kDa	Human Mouse Rat	WB IHC	200ug	59670
CLSDF7286	GOLGA2 Antibody	130kDa	Human Mouse Rat	WB IHC	200ug	59670
CLSDF7287	GTF2A1 Antibody	19kDa	Human Mouse Rat	WB IHC	200ug	59670
CLSDF7288	HADHA Antibody	83kDa	Human Mouse Rat	WB IHC	200ug	59670
CLSDF7289	HDFG Antibody	26kDa	Human Mouse Rat	WB IHC	200ug	59670
CLSDF7290	HFE2 Antibody	45kDa	Human Mouse Rat	WB IHC	200ug	59670
CLSDF7291	IMPDH2 Antibody	55kDa	Human Mouse Rat	WB IHC	200ug	59670
CLSDF7292	LTBR Antibody	46kDa	Human	WB IHC	200ug	59670
CLSDF7293	LUM Antibody	38kDa	Human Mouse Rat	WB IHC	200ug	59670
CLSDF7294	MOG Antibody	28kDa	Human Mouse Rat	WB IHC	200ug	59670
CLSDF7295	MVK Antibody	42kDa	Human Mouse Rat	WB IHC	200ug	59670
CLSDF7296	NEK2 Antibody	51kDa	Human Mouse Rat	WB IHC	200ug	59670
CLSDF7297	PSMD7 Antibody	37kDa	Human Mouse Rat	WB IHC	200ug	59670
CLSDF7298	PSME1 Antibody	28kDa	Human Mouse Rat	WB IHC	200ug	59670
CLSDF7299	RAD17 Antibody	77kDa	Human Mouse Rat	WB IHC	200ug	59670
CLSDF7300	SDCBP Antibody	32kDa	Human Mouse Rat	WB IHC	200ug	59670
CLSDF7301	SMARCE1 Antibody	46kDa	Human Mouse Rat	WB IHC	200ug	59670
CLSDF7302	TCEB2 Antibody	13kDa	Human Mouse Rat	WB IHC	200ug	59670
CLSDF7303	VAPB Antibody	27kDa	Human Mouse Rat	WB IHC	200ug	59670
CLSDF7304	AZGP1 Antibody	34kDa	Human	WB IHC	200ug	59670
CLSDF7305	CHRM5 Antibody	60kDa	Human Mouse Rat	WB IHC	200ug	59670
CLSDF7306	CUL5 Antibody	91kDa	Human Mouse Rat	WB IHC	200ug	59670
CLSDF7307	DBI Antibody	10kDa	Human Mouse Rat	WB IHC	200ug	59670
CLSDF7308	EED Antibody	50kDa	Human Mouse Rat	WB IHC	200ug	59670
CLSDF7309	GFRA1 Antibody	51kDa	Human Mouse Rat	WB IHC	200ug	59670
CLSDF7310	GP9 Antibody	37kDa	Human	WB IHC	200ug	59670
CLSDF7311	PA2G4 Antibody	43kDa	Human Mouse Rat	WB IHC	200ug	59670
CLSDF7312	PSMC6 Antibody	44kDa	Human Mouse Rat	WB IHC	200ug	59670
CLSDF7313	PVRL2 Antibody	57kDa	Human	WB IHC	200ug	59670
CLSDF7314	RAD18 Antibody	56kDa	Human Mouse Rat	WB IHC	200ug	59670
CLSDF7315	RANGAP1 Antibody	63kDa	Human Mouse Rat	WB IHC	200ug	59670
CLSDF7316	TYROBP Antibody	12kDa	Human	WB IHC	200ug	59670
CLSDF7317	WIF1 Antibody	41kDa	Human Mouse Rat	WB IHC	200ug	59670
CLSDF7318	ADAM9 Antibody	91kDa	Human Mouse Rat	WB IHC	200ug	59670
CLSDF7319	AP2A2 Antibody	104kDa	Human Mouse Rat	WB IHC	200ug	59670
CLSDF7320	CFP Antibody	51kDa	Human Mouse Rat	WB IHC	200ug	59670
CLSDF7321	CYB5A Antibody	15kDa	Human Mouse Rat	WB IHC	200ug	59670
CLSDF7322	DLD Antibody	54kDa	Human Mouse Rat	WB IHC	200ug	59670
CLSDF7323	EEF2K Antibody	82kDa	Human Mouse Rat	WB IHC	200ug	59670
CLSDF7324	EIF4B Antibody	69kDa	Human Mouse Rat	WB IHC	200ug	59670
CLSDF7325	FBP1 Antibody	37kDa	Human Mouse Rat	WB IHC	200ug	59670
CLSDF7326	HUS1 Antibody	31kDa	Human Mouse Rat	WB IHC	200ug	59670
CLSDF7327	LIMK2 Antibody	72kDa	Human Mouse Rat	WB IHC	200ug	59670
CLSDF7328	MPG Antibody	32kDa	Human Mouse Rat	WB IHC	200ug	59670
CLSDF7329	NDC80 Antibody	74kDa	Human Mouse Rat	WB IHC	200ug	59670
CLSDF7330	NDUFA13 Antibody	17kDa	Human Mouse Rat	WB IHC	200ug	59670
CLSDF7331	NPC2 Antibody	17kDa	Human Mouse Rat	WB IHC	200ug	59670
CLSDF7332	PCCB Antibody	58kDa	Human Mouse Rat	WB IHC	200ug	59670
CLSDF7333	PEPD Antibody	54kDa	Human Mouse Rat	WB IHC	200ug	59670
CLSDF7334	PRKRA Antibody	34kDa	Human Mouse Rat	WB IHC	200ug	59670
CLSDF7335	SERPINB3 Antibody	44kDa	Human	WB IHC	200ug	59670
CLSDF7336	STXBP1 Antibody	67kDa	Human Mouse Rat	WB IHC	200ug	59670
CLSDF7337	TFDP1 Antibody	45kDa	Human Mouse Rat	WB IHC	200ug	59670
CLSDF7338	WNT7A Antibody	39kDa	Human Mouse Rat	WB IHC	200ug	59670
CLSDF7339	RIPK3 Antibody	56kDa	Mouse	WB IHC	200ug	59670
CLSDF7340	GARS Antibody	75kDa	Human Mouse Rat	WB IHC	200ug	59670



Antibodies

HSN : 38220090

Cat#	Product Description	MW	Reactivity	Application	Pack Size	Unit Price
CLSDF7341	GLUL Antibody	42kDa	Human Mouse Rat	WB IHC	200ug	59670
CLSDF7342	NQO2 Antibody	26kDa	Human Mouse Rat	WB IHC	200ug	59670
CLSDF7343	TPT1 Antibody	20kDa	Human Mouse Rat	WB IHC	200ug	59670
CLSDF7344	MERTK Antibody	110kDa	Human	WB IHC	200ug	59670
CLSDF7345	BCL11A Antibody	91kDa	Human Mouse Rat	WB IHC	200ug	59670
CLSDF7346	CBR1 Antibody	30kDa	Human Mouse Rat	WB IHC	200ug	59670
CLSDF7347	HSD17B10 Antibody	27kDa	Human Mouse Rat	WB IHC	200ug	59670
CLSDF7348	KIF2C Antibody	81kDa	Human Mouse Rat	WB IHC	200ug	59670
CLSDF7349	PER3 Antibody	132kDa	Human Mouse Rat	WB IHC	200ug	59670
CLSDF7350	APRT Antibody	19kDa	Human Mouse Rat	WB IHC	200ug	59670
CLSDF7351	GALNS Antibody	58kDa	Human Mouse Rat	WB IHC	200ug	59670
CLSDF7352	GDI1 Antibody	55kDa	Human Mouse Rat	WB IHC	200ug	59670
CLSDF7353	HDC Antibody	74kDa	Human Mouse Rat	WB IHC	200ug	59670
CLSDF7354	HIF1AN Antibody	40kDa	Human Mouse Rat	WB IHC	200ug	59670
CLSDF7355	IRAK3 Antibody	68kDa	Human	WB IHC	200ug	59670
CLSDF7356	LBR Antibody	70kDa	Human	WB IHC	200ug	59670
CLSDF7357	LITAF Antibody	17kDa	Human Mouse Rat	WB IHC	200ug	59670
CLSDF7358	MB Antibody	17kDa	Human Mouse Rat	WB IHC	200ug	59670
CLSDF7359	NUDT1 Antibody	22kDa	Human Mouse Rat	WB IHC	200ug	59670
CLSDF7360	OTX2 Antibody	31kDa	Human Mouse Rat	WB IHC	200ug	59670
CLSDF7361	PEX19 Antibody	32kDa	Human Mouse Rat	WB IHC	200ug	59670
CLSDF7362	PFKM Antibody	85kDa	Human Mouse Rat	WB IHC	200ug	59670
CLSDF7363	SIGMAR1 Antibody	25kDa	Human Mouse Rat	WB IHC	200ug	59670
CLSDF7364	PRPF3 Antibody	78kDa	Human Mouse Rat	WB IHC	200ug	59670
CLSDF7365	PSMB2 Antibody	22kDa	Human Mouse Rat	WB IHC	200ug	59670
CLSDF7366	PSRC1 Antibody	38kDa	Human	WB IHC	200ug	59670
CLSDF7367	RFC4 Antibody	39kDa	Human Mouse Rat	WB IHC	200ug	59670
CLSDF7368	S100A11 Antibody	11kDa	Human Mouse Rat	WB IHC	200ug	59670
CLSDF7369	SEMG1 Antibody	52kDa	Human	WB IHC	200ug	59670
CLSDF7370	SNRPE Antibody	10kDa	Human Mouse Rat	WB IHC	200ug	59670
CLSDF7371	SULT2A1 Antibody	34kDa	Human	WB IHC	200ug	59670
CLSDF7372	TXNRD2 Antibody	57kDa	Human Mouse Rat	WB IHC	200ug	59670
CLSDF7373	UBD Antibody	18kDa	Human Mouse Rat	WB	200ug	59670
CLSDF7374	UROD Antibody	40kDa	Human Mouse Rat	WB IHC	200ug	59670
CLSDF7375	VIL1 Antibody	93kDa	Human Mouse Rat	WB IHC	200ug	59670
CLSDF7376	Dnmt1 Antibody	183kDa	Human Mouse Rat	WB IHC	200ug	59670
CLSDF7377	IL27 Antibody	27kDa	Human Mouse Rat	WB IHC	200ug	59670
CLSDF7378	UBE2C Antibody	19kDa	Human Mouse Rat	WB IHC	200ug	59670
CLSDF7379	SLC3A1 Antibody	78kDa	Human Mouse Rat	WB IHC	200ug	59670
CLSDF7380	TLE1 Antibody	83kDa	Human Mouse Rat	WB IHC	200ug	59670
CLSDF7381	CTSA Antibody	54kDa	Human Mouse Rat	WB IHC	200ug	59670
CLSDF7382	DNAJB1 Antibody	38kDa	Human Mouse Rat	WB IHC	200ug	59670
CLSDF7383	HNRNPF Antibody	45kDa	Human Mouse Rat	WB IHC	200ug	59670
CLSDF7384	KLK7 Antibody	27kDa	Human	WB IHC	200ug	59670
CLSDF7385	PKP2 Antibody	94kDa	Human Mouse Rat	WB IHC	200ug	59670
CLSDF7386	CALCA Antibody	13kDa	Human	WB IHC	200ug	59670
CLSDF7387	PRDM14 Antibody	64kDa	Human Mouse Rat	WB IHC IF IP CHIP	200ug	59670
CLSDF7388	GNAS Antibody	67kDa	Human Mouse Rat	WB IHC	200ug	59670
CLSDF7389	NRF1 Antibody	53kDa	Human Mouse Rat	WB IHC	200ug	59670
CLSDF7390	UGT1A4 Antibody	60kDa	Human	WB IHC	200ug	59670
CLSDF7391	HAX1 Antibody	31kDa	Human Mouse Rat	WB IHC	200ug	59670
CLSDF7392	KLC1 Antibody	65kDa	Human Mouse Rat	WB IHC	200ug	59670
CLSDF7393	PNMT Antibody	30kDa	Human Mouse Rat	WB IHC	200ug	59670
CLSDF7394	PSMF1 Antibody	29kDa	Human Mouse Rat	WB IHC	200ug	59670
CLSDF7395	TFCP2 Antibody	57kDa	Human Mouse Rat	WB IHC	200ug	59670
CLSDF7396	MCM5 Antibody	82kDa	Human Mouse Rat	WB IHC	200ug	59670
CLSDF7397	RPLP0 Antibody	34kDa	Human Mouse Rat	WB IHC	200ug	59670
CLSDF7398	ASNS Antibody	64kDa	Human Mouse Rat	WB IHC	200ug	59670
CLSDF7399	ATIC Antibody	64kDa	Human Mouse Rat	WB IHC	200ug	59670
CLSDF7400	CDC5L Antibody	92kDa	Human Mouse Rat	WB IHC	200ug	59670
CLSDF7401	LCP1 Antibody	70kDa	Human Mouse Rat	WB IHC	200ug	59670
CLSDF7402	PSME2 Antibody	27kDa	Human Mouse Rat	WB IHC	200ug	59670
CLSDF7403	RNF2 Antibody	37kDa	Human Mouse Rat	WB IHC	200ug	59670
CLSDF7404	SH2B1 Antibody	79kDa	Human Mouse Rat	WB IHC	200ug	59670
CLSDF7405	TACR1 Antibody	46kDa	Human Mouse Rat	WB IHC	200ug	59670
CLSDF7406	CRYBB2 Antibody	23kDa	Human Mouse Rat	WB IHC	200ug	59670
CLSDF7407	WNK3 Antibody	198kDa	Human Mouse Rat	WB IHC	200ug	59670
CLSDF7408	Rab12 Antibody	26kDa	Human Mouse Rat	WB IHC	200ug	59670
CLSDF7409	MTR4 Antibody	118kDa	Human Mouse Rat	WB IHC	200ug	59670
CLSDF7410	WHSC1L1 Antibody	161kDa	Human Mouse	WB IHC	200ug	59670



Antibodies

HSN : 38220090

Cat#	Product Description	MW	Reactivity	Application	Pack Size	Unit Price
CLSDF7411	Eif2ak2 Antibody	62kDa	Human Mouse Rat	WB IHC	200ug	59670
CLSDF7412	MLKL Antibody	54kDa	Human Mouse Rat	WB IHC	200ug	59670
CLSDF7413	ICAM1 Antibody	57kDa	Human	WB IHC	200ug	59670
CLSDF7414	ZEB1 Antibody	124kDa	Human Mouse Rat	WB IHC	200ug	59670
CLSDF7415	HPX Antibody	51kDa	Human	WB IHC	200ug	59670
CLSDF7416	TK1 Antibody	25kDa	Human Mouse Rat	WB IHC	200ug	59670
CLSDF7417	RAB6A Antibody	23kDa	Human Mouse Rat	WB IHC	200ug	59670
CLSDF7418	DCLRE1C Antibody	78kDa	Human Mouse Rat	WB IHC	200ug	59670
CLSDF7419	GABARAP Antibody	13kDa	Human Mouse Rat	WB IHC	200ug	59670
CLSDF7420	LSP1 Antibody	37kDa	Human Mouse Rat	WB IHC	200ug	59670
CLSDF7421	MAP1LC3A Antibody	14kDa	Human Mouse Rat	WB IHC IF	200ug	59670
CLSDF7422	PGRMC1 Antibody	21kDa	Human Mouse Rat	WB IHC	200ug	59670
CLSDF7423	CREM Antibody	38kDa	Human	WB IHC	200ug	59670
CLSDF7424	RAG2 Antibody	59kDa	Human Mouse Rat	WB IHC	200ug	59670
CLSDF7425	TPP1 Antibody	61kDa	Human Mouse Rat	WB IHC	200ug	59670
CLSDF7426	PLTP Antibody	54kDa	Human Mouse Rat	WB IHC	200ug	59670
CLSDF7427	CCL5 Antibody	9kDa	Human	WB IHC	200ug	59670
CLSDF7428	CTNNA1 Antibody	100kDa	Human Mouse Rat	WB IHC	200ug	59670
CLSDF7429	DDX3X Antibody	73kDa	Human Mouse Rat	WB IHC	200ug	59670
CLSDF7430	ECE1 Antibody	87kDa	Human Mouse Rat	WB IHC	200ug	59670
CLSDF7431	ENG Antibody	70kDa	Human	WB IHC	200ug	59670
CLSDF7432	FGG Antibody	51kDa	Human Mouse Rat	WB IHC	200ug	59670
CLSDF7433	FKBP4 Antibody	51kDa	Human Mouse Rat	WB IHC	200ug	59670
CLSDF7434	FLI1 Antibody	50kDa	Human Mouse Rat	WB IHC	200ug	59670
CLSDF7435	FMR1 Antibody	71kDa	Human Mouse Rat	WB IHC	200ug	59670
CLSDF7436	HEXA Antibody	60kDa	Human Mouse Rat	WB IHC	200ug	59670
CLSDF7437	HTR3A Antibody	55kDa	Human Mouse	WB IHC	200ug	59670
CLSDF7438	NLRP3 Antibody	118kDa	Human Rat	WB IHC	200ug	59670
CLSDF7439	OCA2 Antibody	92kDa	Human	WB IHC	200ug	59670
CLSDF7440	PIAS2 Antibody	68kDa	Human Mouse Rat	WB IHC	200ug	59670
CLSDF7441	PLAT Antibody	62kDa	Human Mouse Rat	WB IHC	200ug	59670
CLSDF7442	PPARD Antibody	49kDa	Human Mouse Rat	WB IHC	200ug	59670
CLSDF7443	SMAD4 Antibody	60kDa	Human Mouse Rat	WB IHC	200ug	59670
CLSDF7444	TNFSF12 Antibody	27kDa	Human Mouse Rat	WB IHC	200ug	59670
CLSDF7445	ANPEP Antibody	109kDa	Human Mouse Rat	WB IHC	200ug	59670
CLSDF7446	MME Antibody	85kDa	Human Mouse Rat	WB IHC	200ug	59670
CLSDF7447	AQP4 Antibody	34kDa	Human Mouse Rat	WB IHC	200ug	59670
CLSDF7448	BMPR2 Antibody	115kDa	Human Mouse Rat	WB IHC	200ug	59670
CLSDF7449	CD74 Antibody	33kDa	Human	WB IHC	200ug	59670
CLSDF7450	EFNB2 Antibody	36kDa	Human Mouse Rat	WB IHC	200ug	59670
CLSDF7451	HTR2B Antibody	54kDa	Human Mouse Rat	WB IHC	200ug	59670
CLSDF7452	MDS1 Antibody	118kDa	Human Rat	WB IHC	200ug	59670
CLSDF7453	RBPJ Antibody	55kDa	Human Mouse Rat	WB IHC	200ug	59670
CLSDF7454	ATP7B Antibody	157kDa	Human Mouse Rat	WB IHC	200ug	59670
CLSDF7455	FOXP2 Antibody	79kDa	Human Mouse Rat	WB IHC	200ug	59670
CLSDF7456	ITGA2B Antibody	113kDa	Human	WB IHC	200ug	59670
CLSDF7457	MSH3 Antibody	127kDa	Human	WB IHC	200ug	59670
CLSDF7458	CSTA Antibody	11kDa	Human	WB IHC	200ug	59670
CLSDF7459	DOK1 Antibody	52kDa	Human Mouse Rat	WB IHC	200ug	59670
CLSDF7460	FH Antibody	54kDa	Human Mouse Rat	WB IHC	200ug	59670
CLSDF7461	GRB2 Antibody	25kDa	Human Mouse Rat	WB IHC	200ug	59670
CLSDF7462	GSTP1 Antibody	23kDa	Human Mouse Rat	WB IHC	200ug	59670
CLSDF7463	HPRT1 Antibody	24kDa	Human Mouse Rat	WB IHC	200ug	59670
CLSDF7464	PCM1 Antibody	228kDa	Human Mouse Rat	WB IHC	200ug	59670
CLSDF7465	PSMB4 Antibody	29kDa	Human Mouse Rat	WB IHC	200ug	59670
CLSDF7466	ROCK2 Antibody	160kDa	Human Mouse Rat	WB IHC	200ug	59670
CLSDF7467	SH3GL2 Antibody	39kDa	Human Mouse Rat	WB IHC	200ug	59670
CLSDF7468	SLC3A2 Antibody	67kDa	Human	WB IHC	200ug	59670
CLSDF7469	CLCN5 Antibody	83kDa	Human Mouse Rat	WB IHC	200ug	59670
CLSDF7470	VEGFA Antibody	27kDa	Human Mouse Rat	WB IHC	200ug	59670
CLSDF7471	MAP3K7IP1 Antibody	54kDa	Human Mouse Rat	WB IHC	200ug	59670
CLSDF7472	TP53BP1 Antibody	213kDa	Human Mouse Rat	WB IHC	200ug	59670
CLSDF7473	ATP1B1 Antibody	35kDa	Human Mouse Rat	WB IHC	200ug	59670
CLSDF7500	Tie-2 Antibody	50ug/50ul ,100ug/100ul	Human Mouse Rat	WB IHC	200ug	59670
CLSDF7501	Nephrin Antibody	50ug/50ul ,100ug/100ul	Human Mouse Rat	WB IHC	200ug	59670
CLSDF7502	Cryopyrin Antibody	50ug/50ul ,100ug/100ul	Human Mouse	WB IHC	200ug	59670
CLSDF7503	IRF7 Antibody	50ug/50ul ,100ug/100ul	Human Mouse Rat	WB IHC	200ug	59670

Antibodies
HSN : 38220090

Cat#	Product Description	MW	Reactivity	Application	Pack Size	Unit Price
CLSDF7504	Occludin Antibody	50ug/50ul ,100ug/100ul	Human Mouse Rat	WB IHC	200ug	59670
CLSDF7505	ADH6 Antibody	50ug/50ul ,100ug/100ul	Human Mouse Rat	WB IHC	200ug	59670
CLSDF7506	TXNIP Antibody	50ug/50ul ,100ug/100ul	Human Mouse Rat	WB IHC	200ug	59670
CLSDF7507	CCR2 Antibody	50ug/50ul ,100ug/100ul	Human Mouse Rat	WB IHC	200ug	59670
CLSDF7508	BCL6 Antibody	50ug/50ul ,100ug/100ul	Human Mouse Rat	WB IHC	200ug	59670
CLSDF7509	prouty 4 Antibody	50ug/50ul ,100ug/100ul	Human Mouse Rat	WB IHC	200ug	59670
CLSDF7510	glut2 Antibody	50ug/50ul ,100ug/100ul	Human Mouse Rat	WB IHC	200ug	59670
CLSDF7511	ATR Antibody	50ug/50ul ,100ug/100ul	Human	WB IHC	200ug	59670
CLSDF7512	phospho -ATR(S428) Antibody	50ug/50ul ,100ug/100ul	Human Mouse Rat	WB IHC	200ug	59670
CLSDF7513	TRMP7 Antibody	50ug/50ul ,100ug/100ul	Human Mouse Rat	WB IHC	200ug	59670
CLSDF7514	pan Cadherin Antibody	50ug/50ul ,100ug/100ul	Human Mouse Rat	WB IHC	200ug	59670
CLSDF7515	DVL1 Antibody	50ug/50ul ,100ug/100ul	Human Mouse Rat	WB IHC	200ug	59670
CLSDF7516	lats2 Antibody	50ug/50ul ,100ug/100ul	Human Mouse Rat	WB IHC	200ug	59670
CLSDF7517	lats1 Antibody	50ug/50ul ,100ug/100ul	Human	WB IHC	200ug	59670
CLSDF7518	CD68 Antibody	50ug/50ul ,100ug/100ul	Human Rat	WB IHC	200ug	59670
CLSDF7519	Phospho-nrf2(S40) Antibody	50ug/50ul ,100ug/100ul	Human Mouse Rat	WB IHC	200ug	59670
CLSDF7520	rad21 Antibody	50ug/50ul ,100ug/100ul	Human	WB IHC	200ug	59670
CLSDF7521	TLR2 Antibody	50ug/50ul ,100ug/100ul	Human	WB IHC	200ug	59670
CLSDF7522	Substance P Antibody	50ug/50ul ,100ug/100ul	Human Mouse Rat	WB IHC	200ug	59670
CLSDF7523	GLI1 Antibody	50ug/50ul ,100ug/100ul	Human Mouse Rat	WB IHC	200ug	59670
CLSDF7524	IGF1 Antibody	50ug/50ul ,100ug/100ul	Human	WB IHC	200ug	59670
CLSDF7525	Claspin Antibody	50ug/50ul ,100ug/100ul	Human Mouse Rat	WB IHC	200ug	59670
CLSDF7526	SIN1 Antibody	50ug/50ul ,100ug/100ul	Human Mouse Rat	WB IHC	200ug	59670
CLSDF7527	Raptor Antibody	50ug/50ul ,100ug/100ul	Human Mouse Rat	WB IHC	200ug	59670
CLSDF7528	ASH2 Antibody	50ug/50ul ,100ug/100ul	Human Mouse Rat	WB IHC	200ug	59670
CLSDF7529	USP7 Antibody	50ug/50ul ,100ug/100ul	Human Mouse Rat	WB IHC	200ug	59670
CLSDF7530	RICTOR Antibody	50ug/50ul ,100ug/100ul	Human Mouse Rat	WB IHC	200ug	59670
CLSDF7531	KAP1 Antibody	50ug/50ul ,100ug/100ul	Human	WB	200ug	59670
CLSDF7532	MDM4 Antibody	50ug/50ul ,100ug/100ul	Human Mouse Rat	WB IHC	200ug	59670
CLSDF7533	TRPM2 Antibody	50ug/50ul ,100ug/100ul	Human Mouse Rat	WB IHC	200ug	59670
CLSDF7534	IRS2 Antibody	50ug/50ul ,100ug/100ul	Human Mouse Rat	WB IHC	200ug	59670
CLSDF7535	MCM5 Antibody	50ug/50ul ,100ug/100ul	Human Mouse Rat	WB IHC	200ug	59670
CLSDF7536	CRAM1 Antibody	50ug/50ul ,100ug/100ul	Human Mouse	WB	200ug	59670
CLSDF7537	DDX3 Antibody	50ug/50ul ,100ug/100ul	Human Mouse Rat	WB IHC	200ug	59670
CLSDF7538	CAPER Antibody	50ug/50ul ,100ug/100ul	Human Mouse Rat	WB	200ug	59670
CLSDF7539	DDX5 Antibody	50ug/50ul ,100ug/100ul	Human Mouse Rat	WB IHC	200ug	59670
CLSDF7540	ASC2 Antibody	50ug/50ul ,100ug/100ul	Human Mouse Rat	WB IHC	200ug	59670
CLSDF7541	Gli2 Antibody	50ug/50ul ,100ug/100ul	Human Mouse Rat	WB IHC	200ug	59670
CLSDF7542	AGO1 Antibody	50ug/50ul ,100ug/100ul	Human Mouse Rat	WB IHC	200ug	59670

Antibodies
HSN : 38220090

Cat#	Product Description	MW	Reactivity	Application	Pack Size	Unit Price
CLSDF7543	Mitofusin Antibody	50ug/50ul ,100ug/100ul	Human Mouse Rat	WB IHC	200ug	59670
CLSDF7544	Parvalbumin Antibody	50ug/50ul ,100ug/100ul	Human Mouse Rat	WB IHC	200ug	59670
CLSDF7545	Catalase Antibody	50ug/50ul ,100ug/100ul	Human	WB IHC	200ug	59670
CLSDF7546	RAB7 Antibody	50ug/50ul ,100ug/100ul	Human Mouse Rat	WB IHC	200ug	59670
CLSDF7547	Caveolin 3 Antibody	50ug/50ul ,100ug/100ul	Human Mouse Rat	WB	200ug	59670
CLSDF7552	IBA1 Antibody	50ug/50ul ,100ug/100ul	Human Rat	WB IHC	200ug	59670
CLSDF7553	CD11B Antibody	50ug/50ul ,100ug/100ul	Human Mouse Rat	WB	200ug	59670
CLSDF7554	MCP1 Antibody	50ug/50ul ,100ug/100ul	Human	WB IHC	200ug	59670
CLSDF7556	GM130 Antibody	50ug/50ul ,100ug/100ul	Human Mouse Rat	WB IHC	200ug	59670
CLSDF7557	PAX6 Antibody	50ug/50ul ,100ug/100ul	Human Mouse Rat	WB IHC	200ug	59670
CLSDF7558	SMC3 Antibody	50ug/50ul ,100ug/100ul	Human	WB IHC	200ug	59670
CLSDF7559	NUMB Antibody	50ug/50ul ,100ug/100ul	Human Mouse Rat	WB	200ug	59670
CLSDF7560	AQP2 Antibody	50ug/50ul ,100ug/100ul	Human Mouse Rat	WB IHC	200ug	59670
CLSDF7561	Aggrecan Antibody	50ug/50ul ,100ug/100ul	Human Mouse Rat	WB	200ug	59670
CLSDF7562	Casein Kinase 2 beta Antibody	50ug/50ul ,100ug/100ul	Human Mouse Rat	WB IHC	200ug	59670
CLSDF7563	CKII alpha Antibody	50ug/50ul ,100ug/100ul	Human Mouse Rat	WB IHC	200ug	59670
CLSDF7564	TRIM32 Antibody	50ug/50ul ,100ug/100ul	Human Mouse Rat	WB	200ug	59670
CLSDF7566	MSH6 Antibody	50ug/50ul ,100ug/100ul	Human Mouse Rat	WB IHC	200ug	59670
CLSDF7567	Phospho-IRAK4 (Thr345/Ser346) Antibody	50ug/50ul ,100ug/100ul	Human Mouse Rat	WB IHC	200ug	59670
CLSDF7568	KCNQ1 Antibody	50ug/50ul ,100ug/100ul	Human Mouse Rat	WB IHC	200ug	59670
CLSDF7569	Hes1 Antibody	50ug/50ul ,100ug/100ul	Human Mouse Rat	WB IHC	200ug	59670
CLSDF7570	LEF1 Antibody	50ug/50ul ,100ug/100ul	Human Mouse Rat	WB IHC	200ug	59670
CLSDF7571	Wnt5a Antibody	50ug/50ul ,100ug/100ul	Human Mouse Rat	WB IHC	200ug	59670
CLSDF7572	Wnt10a Antibody	50ug/50ul ,100ug/100ul	Human	WB IHC	200ug	59670
CLSDF7573	PKC epsilon (phospho S729) Antibody	50ug/50ul ,100ug/100ul	Human Mouse Rat	WB IHC	200ug	59670
CLSDF7574	Beta Arrestin 2 Antibody	50ug/50ul ,100ug/100ul	Human Mouse Rat	WB IHC	200ug	59670
CLSDF7575	NLK Antibody	50ug/50ul ,100ug/100ul	Human Mouse Rat	WB IHC	200ug	59670
CLSDF7576	p-PERK (Thr 981) Antibody	50ug/50ul ,100ug/100ul	Human Mouse Rat	WB IHC	200ug	59670
CLSDF7577	MCP-1 Antibody	50ug/50ul ,100ug/100ul	Human Mouse Rat	WB IHC	200ug	59670
CLSDF7578	Phospho-Doublecortin (Ser334) Antibody	50ug/50ul ,100ug/100ul	Human	WB IHC	200ug	59670
CLSDF7579	APG5L/ATG5 Antibody	50ug/50ul ,100ug/100ul	Human Rat	WB IHC	200ug	59670
CLSDF7580	LEF1 Antibody	50ug/50ul ,100ug/100ul	Human Mouse Rat	WB IHC	200ug	59670
CLSDF7581	BRG1 Antibody	50ug/50ul ,100ug/100ul	Human	WB IHC	200ug	59670
CLSDF7582	Rab10 Antibody	50ug/50ul ,100ug/100ul	Human	WB IHC	200ug	59670
CLSDF7583	SIX2 Antibody	50ug/50ul ,100ug/100ul	Human Mouse Rat	WB IHC	200ug	59670
CLSDF7584	ALDH2 Antibody	50ug/50ul ,100ug/100ul	Human Mouse Rat	WB IHC	200ug	59670
CLSDF7585	CD11c Antibody	50ug/50ul ,100ug/100ul	Human	WB IHC	200ug	59670
CLSDF7586	Calretinin Antibody	50ug/50ul ,100ug/100ul	Human Mouse Rat	WB IHC	200ug	59670
CLSDF7587	Phospho-ULK1(S556) Antibody	50ug/50ul ,100ug/100ul	Human Mouse Rat	WB IHC	200ug	59670

Antibodies
HSN : 38220090

Cat#	Product Description	MW	Reactivity	Application	Pack Size	Unit Price
CLSD7588	ULK1 Antibody	50ug/50ul ,100ug/100ul	Human Mouse Rat	WB IHC	200ug	59670
CLSD7589	Phospho-PKA C (Thr197) Antibody	50ug/50ul ,100ug/100ul	Human Mouse Rat	WB IHC	200ug	59670
CLSD7590	CLCN3 Antibody	50ug/50ul ,100ug/100ul	Human Mouse Rat	WB IHC	200ug	59670
CLSD7591	USP22 Antibody	50ug/50ul ,100ug/100ul	Human Mouse Rat	WB IHC	200ug	59670
CLSD7592	Angiotensin II Type 1 Receptor Antibody	50ug/50ul ,100ug/100ul	Human	WB	200ug	59670
CLSD7593	PDI Antibody	50ug/50ul ,100ug/100ul	Human Mouse Rat	WB	200ug	59670
CLSD7594	BACE Antibody	50ug/50ul ,100ug/100ul	Human Mouse Rat	WB	200ug	59670
CLSD7595	HNF-4A Antibody	50ug/50ul ,100ug/100ul	Human Mouse Rat	WB	200ug	59670
CLSD7596	S100A9 Antibody	50ug/50ul ,100ug/100ul	Human Mouse Rat	WB IHC	200ug	59670
CLSD7597	Phospho-HER3/ErbB3 (Tyr1289) Antibody	50ug/50ul ,100ug/100ul	Human Mouse Rat	WB IHC	200ug	59670
CLSD7598	Elastin Antibody	50ug/50ul ,100ug/100ul	Human Mouse Rat	WB	200ug	59670
CLSD7599	NKp46 Antibody	50ug/50ul ,100ug/100ul	Human Mouse Rat	WB IHC	200ug	59670
CLSD7600	Prohibitin Antibody	50ug/50ul ,100ug/100ul	Human Mouse Rat	WB IHC	200ug	59670
CLSD7601	SREBP2 Antibody	50ug/50ul ,100ug/100ul	Human Mouse Rat	WB IHC	200ug	59670
CLSD7602	Perilipin A Antibody	50ug/50ul ,100ug/100ul	Human Mouse Rat	WB IHC	200ug	59670
CLSD7603	ADFP Antibody	50ug/50ul ,100ug/100ul	Human Mouse Rat	WB	200ug	59670
CLSD7604	Neuropilin-2 Antibody	50ug/50ul ,100ug/100ul	Human Mouse Rat	WB IHC	200ug	59670
CLSD7605	Pax-6 Antibody	50ug/50ul ,100ug/100ul	Human Mouse Rat	WB IHC	200ug	59670
CLSD7606	Cdx2 Antibody	50ug/50ul ,100ug/100ul	Human Mouse Rat	WB IHC	200ug	59670
CLSD7607	Glutamine Synthetase Antibody	50ug/50ul ,100ug/100ul	Human Mouse Rat	WB IHC	200ug	59670
CLSD7608	Doublecortin Antibody	50ug/50ul ,100ug/100ul	Human Mouse Rat	WB IHC	200ug	59670
CLSD7609	caspase-11 Antibody	50ug/50ul ,100ug/100ul	Human Mouse Rat	WB IHC	200ug	59670
CLSD7612	ASIP Antibody	50ug/50ul ,100ug/100ul	Human	WB	200ug	59670
CLSD7613	CARD11 Antibody	50ug/50ul ,100ug/100ul	Human	WB	200ug	59670
CLSD7614	EIF4G1 Antibody	50ug/50ul ,100ug/100ul	Human	WB	200ug	59670
CLSD7616	JAG2 Antibody	50ug/50ul ,100ug/100ul	Human, Mouse,Rat	WB	200ug	59670
CLSD7617	JAG2 Antibody	50ug/50ul ,100ug/100ul	Human, Mouse,Rat	WB	200ug	59670
CLSD7618	PIK3CD Antibody	50ug/50ul ,100ug/100ul	Human, Mouse,Rat	WB	200ug	59670
CLSD7619	HRAS Antibody	50ug/50ul ,100ug/100ul	Human	WB	200ug	59670
CLSD7620	STXBP4 Antibody	50ug/50ul ,100ug/100ul	Human	WB IHC	200ug	59670
CLSD7621	TXN Antibody	50ug/50ul ,100ug/100ul	Human, Mouse,Rat	WB	200ug	59670
CLSD7622	TCF7L2 Antibody	50ug/50ul ,100ug/100ul	Human, Mouse,Rat	WB	200ug	59670
CLSD7623	TXN Antibody	50ug/50ul ,100ug/100ul	Human, Mouse,Rat	WB	200ug	59670
CLSD7624	APAF1 Antibody	50ug/50ul ,100ug/100ul	Human, Mouse,Rat	WB	200ug	59670
CLSD7625	BIRC3 Antibody	50ug/50ul ,100ug/100ul	Human	WB	200ug	59670
CLSD7626	HTRA2 Antibody	50ug/50ul ,100ug/100ul	Human	WB	200ug	59670
CLSD7627	HTRA2 Antibody	50ug/50ul ,100ug/100ul	Human, Mouse	WB	200ug	59670
CLSD7628	DAP Antibody	50ug/50ul ,100ug/100ul	Human, Mouse,Rat	WB	200ug	59670
CLSD7629	TMX2 Antibody	50ug/50ul ,100ug/100ul	Human	WB IHC	200ug	59670

Antibodies
HSN : 38220090

Cat#	Product Description	MW	Reactivity	Application	Pack Size	Unit Price
CLSDF7630	LAT Antibody	50ug/50ul ,100ug/100ul	Human	WB IF/ICC	200ug	59670
CLSDF7631	PLEC Antibody	50ug/50ul ,100ug/100ul	Human, Mouse,Rat	WB	200ug	59670
CLSDF7632	MAPKAPK2 Antibody	50ug/50ul ,100ug/100ul	Human, Mouse,Rat	WB	200ug	59670
CLSDF7633	LAT Antibody	50ug/50ul ,100ug/100ul	Human	WB	200ug	59670
CLSDF7634	PPP2CA Antibody	50ug/50ul ,100ug/100ul	Human	WB	200ug	59670
CLSDF7635	TMX2 Antibody	50ug/50ul ,100ug/100ul	Human	WB	200ug	59670
CLSDF7636	PPP2CA Antibody	50ug/50ul ,100ug/100ul	Human, Mouse,Rat	WB IHC	200ug	59670
CLSDF7637	HRAS Antibody	50ug/50ul ,100ug/100ul	Human, Mouse,Rat	WB	200ug	59670
CLSDF7638	LAMTOR3 Antibody	50ug/50ul ,100ug/100ul	Human, Mouse,Rat	WB	200ug	59670
CLSDF7639	CCNA2 Antibody	50ug/50ul ,100ug/100ul	Human	WB	200ug	59670
CLSDF7640	CCNA2 Antibody	50ug/50ul ,100ug/100ul	Human, Mouse,Rat	WB	200ug	59670
CLSDF7641	NRAS Antibody	50ug/50ul ,100ug/100ul	Human, Mouse,Rat	WB	200ug	59670
CLSDF7642	CASP2 Antibody	50ug/50ul ,100ug/100ul	Human	WB	200ug	59670
CLSDF7643	RHOQ Antibody	50ug/50ul ,100ug/100ul	Human, Mouse,Rat	WB	200ug	59670
CLSDF7644	PIK3CD Antibody	50ug/50ul ,100ug/100ul	Human, Mouse,Rat	WB	200ug	59670
CLSDF7645	C11orf30 Antibody	50ug/50ul ,100ug/100ul	Human	WB	200ug	59670
CLSDF7646	CD22 Antibody	50ug/50ul ,100ug/100ul	Human	WB	200ug	59670
CLSDF7647	CD22 Antibody	50ug/50ul ,100ug/100ul	Human, Mouse	WB IHC	200ug	59670
CLSDF7648	CD22 Antibody	50ug/50ul ,100ug/100ul	Human	WB	200ug	59670
CLSDF7649	ARHGAP5 Antibody	50ug/50ul ,100ug/100ul	Human	WB	200ug	59670
CLSDF7650	ARF1 Antibody	50ug/50ul ,100ug/100ul	Human, Mouse	WB	200ug	59670
CLSDF7651	CD22 Antibody	50ug/50ul ,100ug/100ul	Human	WB IF/ICC	200ug	59670
CLSDF7652	BCL2A1 Antibody	50ug/50ul ,100ug/100ul	Human	WB IF/ICC	200ug	59670
CLSDF7653	CYTH3 Antibody	50ug/50ul ,100ug/100ul	Human	WB	200ug	59670
CLSDF7654	IL15 Antibody	50ug/50ul ,100ug/100ul	Human	WB IHC	200ug	59670
CLSDF7655	STXBP4 Antibody	50ug/50ul ,100ug/100ul	Human	WB	200ug	59670
CLSDF7656	INSRR Antibody	50ug/50ul ,100ug/100ul	Human	WB IHC IF/ICC	200ug	59670
CLSDF7657	IL1R1 Antibody	50ug/50ul ,100ug/100ul	Human	WB	200ug	59670
CLSDF7658	CAD Antibody	50ug/50ul ,100ug/100ul	Human	WB	200ug	59670
CLSDF7659	MYCB Antibody	50ug/50ul ,100ug/100ul	Human, Mouse,Rat	WB	200ug	59670
CLSDF7660	CAD Antibody	50ug/50ul ,100ug/100ul	Human	WB	200ug	59670
CLSDF7661	CENPA Antibody	50ug/50ul ,100ug/100ul	Human	WB	200ug	59670
CLSDF7662	PPP1R1A Antibody	50ug/50ul ,100ug/100ul	Human	WB	200ug	59670
CLSDF7663	HTT Antibody	50ug/50ul ,100ug/100ul	Human	WB	200ug	59670
CLSDF7664	CASP5 Antibody	50ug/50ul ,100ug/100ul	Human, Mouse,Rat	WB	200ug	59670
CLSDF7665	CD22 Antibody	50ug/50ul ,100ug/100ul	Human, Mouse	WB IF/ICC	200ug	59670
CLSDF7666	FCGR2B Antibody	50ug/50ul ,100ug/100ul	Human, Mouse,Rat	WB	200ug	59670
CLSDF7667	MAP2K5 Antibody	50ug/50ul ,100ug/100ul	Human	WB	200ug	59670
CLSDF7668	IRS2 Antibody	50ug/50ul ,100ug/100ul	Human	WB	200ug	59670

Antibodies
HSN : 38220090

Cat#	Product Description	MW	Reactivity	Application	Pack Size	Unit Price
CLSDF7669	MAG Antibody	50ug/50ul ,100ug/100ul	Human, Mouse	WB IHC	200ug	59670
CLSDF7670	AURKC Antibody	50ug/50ul ,100ug/100ul	Human	WB	200ug	59670
CLSDF7671	CNN1 Antibody	50ug/50ul ,100ug/100ul	Human	WB	200ug	59670
CLSDF7672	CHGA Antibody	50ug/50ul ,100ug/100ul	Human, Mouse	WB	200ug	59670
CLSDF7673	NEFM Antibody	50ug/50ul ,100ug/100ul	Human, Mouse	WB	200ug	59670
CLSDF7674	FADD Antibody	50ug/50ul ,100ug/100ul	Human	WB	200ug	59670
CLSDF7675	KCND2 Antibody	50ug/50ul ,100ug/100ul	Human, Mouse,Rat	WB	200ug	59670
CLSDF7676	FLT3LG Antibody	50ug/50ul ,100ug/100ul	Human	WB	200ug	59670
CLSDF7677	ACTC1 Antibody	50ug/50ul ,100ug/100ul	Human, Mouse,Rat	WB	200ug	59670
CLSDF7678	CD40LG Antibody	50ug/50ul ,100ug/100ul	Human, Mouse	WB IF/ICC	200ug	59670
CLSDF7679	IRS2 Antibody	50ug/50ul ,100ug/100ul	Human	WB	200ug	59670
CLSDF7680	CSF2RB Antibody	50ug/50ul ,100ug/100ul	Human, Mouse	WB	200ug	59670
CLSDF7681	EPS15L1 Antibody	50ug/50ul ,100ug/100ul	Human, Mouse,Rat	WB	200ug	59670
CLSDF7682	CD80 Antibody	50ug/50ul ,100ug/100ul	Human	WB IF/ICC	200ug	59670
CLSDF7683	SMURF2 Antibody	50ug/50ul ,100ug/100ul	Human	WB	200ug	59670
CLSDF7684	TIRAP Antibody	50ug/50ul ,100ug/100ul	Human	WB	200ug	59670
CLSDF7685	DNAJC3 Antibody	50ug/50ul ,100ug/100ul	Human, Mouse,Rat	WB	200ug	59670
CLSDF7686	MMP12 Antibody	50ug/50ul ,100ug/100ul	Human	WB	200ug	59670
CLSDF7687	SUFU Antibody	50ug/50ul ,100ug/100ul	Human	WB	200ug	59670
CLSDF7688	IHH Antibody	50ug/50ul ,100ug/100ul	Human	WB	200ug	59670
CLSDF7689	TGIF1 Antibody	50ug/50ul ,100ug/100ul	Human, Mouse,Rat	WB	200ug	59670
CLSDF7690	IPO9 Antibody	50ug/50ul ,100ug/100ul	Human	WB	200ug	59670
CLSDF7691	STK4 Antibody	50ug/50ul ,100ug/100ul	Human	WB	200ug	59670
CLSDF7692	STK3 Antibody	50ug/50ul ,100ug/100ul	Human, Mouse,Rat	WB	200ug	59670
CLSDF7693	ABCG1 Antibody	50ug/50ul ,100ug/100ul	Human	WB	200ug	59670
CLSDF7694	MMP20 Antibody	50ug/50ul ,100ug/100ul	Human	WB	200ug	59670
CLSDF7695	MMP21 Antibody	50ug/50ul ,100ug/100ul	Human, Mouse	WB	200ug	59670
CLSDF7696	LDLR Antibody	50ug/50ul ,100ug/100ul	Human, Mouse,Rat	WB	200ug	59670
CLSDF7697	CRADD Antibody	50ug/50ul ,100ug/100ul	Human, Mouse,Rat	WB	200ug	59670
CLSDF7698	IRS4 Antibody	50ug/50ul ,100ug/100ul	Human	WB	200ug	59670
CLSDF7699	ARPC5 Antibody	50ug/50ul ,100ug/100ul	Human	WB	200ug	59670
CLSDF7700	PRKD2 Antibody	50ug/50ul ,100ug/100ul	Human	WB	200ug	59670
CLSDF7701	RSK1 p90 Antibody	50ug/50ul ,100ug/100ul	Human, Mouse,Rat	WB	200ug	59670
CLSDF7702	RSK1 p90 (phospho S380) Antibody	50ug/50ul ,100ug/100ul	Human, Mouse,Rat	WB	200ug	59670
CLSDF7703	HE4 Antibody	50ug/50ul ,100ug/100ul	Human	WB	200ug	59670
CLSDF7704	EZH2 (phospho T487) Antibody	50ug/50ul ,100ug/100ul	Human	WB	200ug	59670
CLSDF7705	Ferritin Heavy Chain Antibody	50ug/50ul ,100ug/100ul	Human	WB	200ug	59670
CLSDF7706	Dicer Antibody	50ug/50ul ,100ug/100ul	Human	WB	200ug	59670
CLSDF7707	ABCG1 Antibody	50ug/50ul ,100ug/100ul	Human	WB IHC	200ug	59670

Antibodies
HSN : 38220090

Cat#	Product Description	MW	Reactivity	Application	Pack Size	Unit Price
CLSDF7708	ERG1 Antibody	50ug/50ul ,100ug/100ul	Human, Mouse,Rat	WB IHC IF/ICC	200ug	59670
CLSDF7709	IRE1 Antibody	50ug/50ul ,100ug/100ul	Human	WB IF/ICC	200ug	59670
CLSDF7710	67kDa Laminin Receptor Antibody	50ug/50ul ,100ug/100ul	Human, Mouse,Rat	WB	200ug	59670
CLSDF7711	Gelsolin Antibody	50ug/50ul ,100ug/100ul	Human	WB	200ug	59670
CLSDF7712	MYOD1 Antibody	50ug/50ul ,100ug/100ul	Human	WB	200ug	59670
CLSDF7713	Smurf Antibody	50ug/50ul ,100ug/100ul	Human, Mouse	WB	200ug	59670
CLSDF7714	Renin Antibody	50ug/50ul ,100ug/100ul	Human	WB IHC	200ug	59670
CLSDF7715	Amylin Antibody	50ug/50ul ,100ug/100ul	Human, Mouse,Rat	WB IHC	200ug	59670
CLSDF7716	FATP1 Antibody	50ug/50ul ,100ug/100ul	Human, Mouse,Rat	WB	200ug	59670
CLSDF7717	Aquaporin 7 Antibody	50ug/50ul ,100ug/100ul	Human	WB	200ug	59670
CLSDF7718	AMFR Antibody	50ug/50ul ,100ug/100ul	Human	WB IHC	200ug	59670
CLSDF7719	C5 Antibody	50ug/50ul ,100ug/100ul	Human, Mouse	WB	200ug	59670
CLSDF7720	UCP1 Antibody	50ug/50ul ,100ug/100ul	Human	WB IHC	200ug	59670
CLSDF7721	Pannexin-3 Antibody	50ug/50ul ,100ug/100ul	Human	WB	200ug	59670
CLSDF7722	Occludin Antibody	50ug/50ul ,100ug/100ul	Human, Mouse,Rat	WB	200ug	59670
CLSDF7723	IRG1 Antibody	50ug/50ul ,100ug/100ul	Human	WB	200ug	59670
CLSDF7724	NEDD4-2 Antibody	50ug/50ul ,100ug/100ul	Human, Mouse	WB	200ug	59670
CLSDF7725	ILP2 Antibody	50ug/50ul ,100ug/100ul	Human, Mouse,Rat	WB	200ug	59670
CLSDF7726	Phospholamban Antibody	50ug/50ul ,100ug/100ul	Human, Mouse,Rat	WB	200ug	59670
CLSDF7727	GDNF Antibody	50ug/50ul ,100ug/100ul	Human	WB	200ug	59670
CLSDF7728	Pan Methylated Lysine Rabbit pAb	50ug/50ul ,100ug/100ul	Human	WB	200ug	59670
CLSDF7729	Acetyl Lysine Rabbit pAb	50ug/50ul ,100ug/100ul	Human	WB	200ug	59670
CLSDF7730	CXCR1 Antibody	50ug/50ul ,100ug/100ul	Human	WB	200ug	59670
CLSDF7731	Osterix Antibody	50ug/50ul ,100ug/100ul	Human, Mouse,Rat	WB	200ug	59670
CLSDF7732	Spermidine Antibody	50ug/50ul ,100ug/100ul	Human, Mouse,Rat	WB	200ug	59670
CLSDF7733	PPT1 Antibody	50ug/50ul ,100ug/100ul	Human, Mouse,Rat	WB	200ug	59670
CLSDF7734	UGT2B Antibody	50ug/50ul ,100ug/100ul	Human	WB	200ug	59670
CLSDF7735	CD105 Antibody	50ug/50ul ,100ug/100ul	Human, Mouse	WB	200ug	59670
CLSDF7736	CD166 Antibody	50ug/50ul ,100ug/100ul	Human, Mouse	WB	200ug	59670
CLSDF7737	LGR4 Antibody	50ug/50ul ,100ug/100ul	Human	WB	200ug	59670
CLSDF7738	Bone Sialoprotein Antibody	50ug/50ul ,100ug/100ul	Human, Mouse	WB	200ug	59670
CLSDF7739	Smurf1 Antibody	50ug/50ul ,100ug/100ul	Human, Mouse	WB	200ug	59670
CLSDF7740	IL15 Antibody	50ug/50ul ,100ug/100ul	Human, Mouse,Rat	WB	200ug	59670
CLSDF7741	Cathelicidin Antibody	50ug/50ul ,100ug/100ul	Human	WB IHC	200ug	59670
CLSDF7742	PINK1 Antibody	50ug/50ul ,100ug/100ul	Human, Mouse,Rat	WB IHC	200ug	59670
CLSDF7743	BIGM103 Antibody	50ug/50ul ,100ug/100ul	Human	WB IHC	200ug	59670
CLSDF7744	Choline Acetyltransferase Antibody	50ug/50ul ,100ug/100ul	Human	WB	200ug	59670
CLSDF7745	CENP-E Antibody	50ug/50ul ,100ug/100ul	Human	WB	200ug	59670
CLSDF7746	Ihh Antibody	50ug/50ul ,100ug/100ul	Human, Mouse,Rat	WB	200ug	59670

Antibodies
HSN : 38220090

Cat#	Product Description	MW	Reactivity	Application	Pack Size	Unit Price
CLSDF7747	Shh Antibody	50ug/50ul ,100ug/100ul	Human, Mouse	WB	200ug	59670
CLSDF7748	GLIS1 Antibody	50ug/50ul ,100ug/100ul	Human	WB	200ug	59670
CLSDF7749	GLIS3 Antibody	50ug/50ul ,100ug/100ul	Human	WB	200ug	59670
CLSDF7750	GLP1R Antibody	50ug/50ul ,100ug/100ul	Human,Rat	WB	200ug	59670
CLSDF7751	CD134 Antibody	50ug/50ul ,100ug/100ul	Human	WB	200ug	59670
CLSDF7752	ZKSCAN3 Antibody	50ug/50ul ,100ug/100ul	Human, Mouse	WB	200ug	59670
CLSDF7753	SOD-3 Antibody	50ug/50ul ,100ug/100ul	Human, Mouse,Rat	WB	200ug	59670
CLSDF7754	Nestin Antibody	50ug/50ul ,100ug/100ul	Human, Mouse,Rat	WB	200ug	59670
CLSDF7755	PRMT7 Antibody	50ug/50ul ,100ug/100ul	Human, Mouse	WB	200ug	59670
CLSDF7756	ATGL Antibody	50ug/50ul ,100ug/100ul	Human, Mouse	WB IHC	200ug	59670
CLSDF7757	Sall4 Antibody	50ug/50ul ,100ug/100ul	Human, Mouse,Rat	WB	200ug	59670
CLSDF7758	BMP9 Antibody	50ug/50ul ,100ug/100ul	Human	WB	200ug	59670
CLSDF7759	tbx21 Antibody	50ug/50ul ,100ug/100ul	Human, Mouse,Rat	WB IHC	200ug	59670
CLSDF7760	OAS1 Antibody	50ug/50ul ,100ug/100ul	Human, Mouse,Rat	WB	200ug	59670
CLSDF7761	FGF3 Antibody	50ug/50ul ,100ug/100ul	Human,Rat	WB IHC	200ug	59670
CLSDF7762	F4/80 Antibody	50ug/50ul ,100ug/100ul	Human	WB	200ug	59670
CLSDF7763	Mnk1 Antibody	50ug/50ul ,100ug/100ul	Human	WB	200ug	59670
CLSDF7764	eIF4G Antibody	50ug/50ul ,100ug/100ul	Human	WB	200ug	59670
CLSDF7765	IGFBP2 Antibody	50ug/50ul ,100ug/100ul	Human	WB	200ug	59670
CLSDF7766	GAP43 Antibody	50ug/50ul ,100ug/100ul	Human	WB	200ug	59670
CLSDF7767	SIAH2 Antibody	50ug/50ul ,100ug/100ul	Human	WB IHC	200ug	59670
CLSDF7768	Phospho-MAP2K7(Thr275) Antibody	50ug/50ul ,100ug/100ul	Human, Mouse,Rat	WB	200ug	59670
CLSDF7769	ANO1 Antibody	50ug/50ul ,100ug/100ul	Human, Mouse,Rat	WB	200ug	59670
CLSDF7770	CR2 Antibody	50ug/50ul ,100ug/100ul	Human, Mouse,Rat	WB	200ug	59670
CLSDF7771	Phospho-PKM2 (Tyr105) Antibody	50ug/50ul ,100ug/100ul	Human, Mouse,Rat	WB	200ug	59670
CLSDF7772	PKM2(phospho-Ser37) Antibody	50ug/50ul ,100ug/100ul	Human, Mouse	WB	200ug	59670
CLSDF7773	CRYAB Antibody	50ug/50ul ,100ug/100ul	Human, Mouse,Rat	WB IHC	200ug	59670
CLSDF7774	CRYAB Antibody	50ug/50ul ,100ug/100ul	Human	WB	200ug	59670
CLSDF7775	ESRRA Antibody	50ug/50ul ,100ug/100ul	Human	WB	200ug	59670
CLSDF7776	TFAP2C Antibody	50ug/50ul ,100ug/100ul	Human	WB IHC	200ug	59670
CLSDF7777	YBX1 Antibody	50ug/50ul ,100ug/100ul	Human, Mouse,Rat	WB	200ug	59670
CLSDF7778	SOAT1 Antibody	50ug/50ul ,100ug/100ul	Human	WB IHC	200ug	59670
CLSDF7779	SOAT1 Antibody	50ug/50ul ,100ug/100ul	Human, Mouse,Rat	WB	200ug	59670
CLSDF7780	ARPC5 Antibody	50ug/50ul ,100ug/100ul	Human, Mouse	WB	200ug	59670
CLSDF7781	CCL22 Antibody	50ug/50ul ,100ug/100ul	Human, Mouse,Rat	WB	200ug	59670
CLSDF7782	FADD Antibody	50ug/50ul ,100ug/100ul	Human	WB	200ug	59670
CLSDF7783	GNB2 Antibody	50ug/50ul ,100ug/100ul	Human, Mouse,Rat	WB IHC	200ug	59670
CLSDF7784	HRAS Antibody	50ug/50ul ,100ug/100ul	Human, Mouse,Rat	WB IHC	200ug	59670
CLSDF7785	CALCA Antibody	50ug/50ul ,100ug/100ul	Human	WB	200ug	59670

Antibodies
HSN : 38220090

Cat#	Product Description	MW	Reactivity	Application	Pack Size	Unit Price
CLSDF7786	CALCA Antibody	50ug/50ul ,100ug/100ul	Human, Mouse,Rat	WB	200ug	59670
CLSDF7787	CASP2 Antibody	50ug/50ul ,100ug/100ul	Human	WB	200ug	59670
CLSDF7788	GFP Antibody	50ug/50ul ,100ug/100ul	Human, Mouse,Rat	WB	200ug	59670
CLSDF7789	KRT6A Antibody	50ug/50ul ,100ug/100ul	Human, Mouse,Rat	WB IHC	200ug	59670
CLSDF7790	HSD17B1 Antibody	50ug/50ul ,100ug/100ul	Human	WB	200ug	59670
CLSDF7791	NODAL Antibody	50ug/50ul ,100ug/100ul	Human, Mouse,Rat	WB	200ug	59670
CLSDF7792	DAB2 Antibody	50ug/50ul ,100ug/100ul	Human, Mouse	WB	200ug	59670
CLSDF7793	KSR1 Antibody	50ug/50ul ,100ug/100ul	Human, Mouse,Rat	WB	200ug	59670
CLSDF7794	RBL2 Antibody	50ug/50ul ,100ug/100ul	Human	WB	200ug	59670
CLSDF7795	SYNJ2 Antibody	50ug/50ul ,100ug/100ul	Human, Mouse,Rat	WB	200ug	59670
CLSDF7796	LAT Antibody	50ug/50ul ,100ug/100ul	Human	WB	200ug	59670
CLSDF7797	NEFM Antibody	50ug/50ul ,100ug/100ul	Human	WB	200ug	59670
CLSDF7798	MRC2 Antibody	50ug/50ul ,100ug/100ul	Human	WB	200ug	59670
CLSDF7799	ACTN2 Antibody	50ug/50ul ,100ug/100ul	Human, Mouse,Rat	WB	200ug	59670
CLSDF7800	GABBR2 Antibody	50ug/50ul ,100ug/100ul	Human, Mouse,Rat	WB	200ug	59670
CLSDF7801	EIF2AK4 Antibody	50ug/50ul ,100ug/100ul	Human	WB	200ug	59670
CLSDF7802	PLD1 Antibody	50ug/50ul ,100ug/100ul	Human, Mouse,Rat	WB	200ug	59670
CLSDF7803	ACTN3 Antibody	50ug/50ul ,100ug/100ul	Human, Mouse,Rat	WB	200ug	59670
CLSDF7804	GABBR2 Antibody	50ug/50ul ,100ug/100ul	Human	WB	200ug	59670
CLSDF7805	CAMK1 Antibody	50ug/50ul ,100ug/100ul	Human	WB	200ug	59670
CLSDF7806	ACTN2 Antibody	50ug/50ul ,100ug/100ul	Human, Mouse	WB	200ug	59670
CLSDF7807	CAPN2 Antibody	50ug/50ul ,100ug/100ul	Human, Mouse,Rat	WB	200ug	59670
CLSDF7808	CHGA Antibody	50ug/50ul ,100ug/100ul	Human	WB IHC	200ug	59670
CLSDF7809	PSEN2 Antibody	50ug/50ul ,100ug/100ul	Human,Rat	WB IHC	200ug	59670
CLSDF7810	HNRNPUL1 Antibody	50ug/50ul ,100ug/100ul	Human	WB	200ug	59670
CLSDF7811	FADD Antibody	50ug/50ul ,100ug/100ul	Human, Mouse,Rat	WB	200ug	59670
CLSDF7812	TNFRSF4 Antibody	50ug/50ul ,100ug/100ul	Human, Mouse,Rat	WB	200ug	59670
CLSDF7813	FYB Antibody	50ug/50ul ,100ug/100ul	Human, Mouse,Rat	WB IHC	200ug	59670
CLSDF7814	FYB Antibody	50ug/50ul ,100ug/100ul	Human	WB	200ug	59670
CLSDF7815	PSEN2 Antibody	50ug/50ul ,100ug/100ul	Human, Mouse,Rat	WB IHC	200ug	59670
CLSDF7816	TNFSF4 Antibody	50ug/50ul ,100ug/100ul	Human	WB IHC	200ug	59670
CLSDF7817	MYBL2 Antibody	50ug/50ul ,100ug/100ul	Human	WB IHC	200ug	59670
CLSDF7818	VAMP8 Antibody	50ug/50ul ,100ug/100ul	Human	WB	200ug	59670
CLSDF7819	TFAP2C Antibody	50ug/50ul ,100ug/100ul	Human	WB	200ug	59670
CLSDF7820	PRKAR2B Antibody	50ug/50ul ,100ug/100ul	Human, Mouse,Rat	WB	200ug	59670
CLSDF7821	YBX1 Antibody	50ug/50ul ,100ug/100ul	Human	WB	200ug	59670
CLSDF7822	EPS15L1 Antibody	50ug/50ul ,100ug/100ul	Human	WB	200ug	59670
CLSDF7823	TFAP2C Antibody	50ug/50ul ,100ug/100ul	Human, Mouse,Rat	WB	200ug	59670
CLSDF7824	KSR1 Antibody	50ug/50ul ,100ug/100ul	Human, Mouse	WB	200ug	59670

Antibodies
HSN : 38220090

Cat#	Product Description	MW	Reactivity	Application	Pack Size	Unit Price
CLSDF7825	HMGB3 Antibody	50ug/50ul ,100ug/100ul	Human, Mouse	WB	200ug	59670
CLSDF7826	REST Antibody	50ug/50ul ,100ug/100ul	Human,Rat	WB	200ug	59670
CLSDF7827	CRYAB Antibody	50ug/50ul ,100ug/100ul	Human, Mouse	WB IHC	200ug	59670
CLSDF7828	SUFU Antibody	50ug/50ul ,100ug/100ul	Human	WB IHC	200ug	59670
CLSDF7829	EIF2AK4 Antibody	50ug/50ul ,100ug/100ul	Human	WB	200ug	59670
CLSDF7830	PABPN1 Antibody	50ug/50ul ,100ug/100ul	Human, Mouse	WB	200ug	59670
CLSDF7831	CDC6 Antibody	50ug/50ul ,100ug/100ul	Human	WB	200ug	59670
CLSDF7832	NCAM1 Antibody	50ug/50ul ,100ug/100ul	Human	WB	200ug	59670
CLSDF7833	CALB2 Antibody	50ug/50ul ,100ug/100ul	Human	WB	200ug	59670
CLSDF7834	CALB2 Antibody	50ug/50ul ,100ug/100ul	Human, Mouse,Rat	WB	200ug	59670
CLSDF7835	CTNBL1 Antibody	50ug/50ul ,100ug/100ul	Human	WB IHC	200ug	59670
CLSDF7836	APBB1IP Antibody	50ug/50ul ,100ug/100ul	Human, Mouse	WB	200ug	59670
CLSDF7837	LRP6 Antibody	50ug/50ul ,100ug/100ul	Human	WB IHC	200ug	59670
CLSDF7838	CDC6 Antibody	50ug/50ul ,100ug/100ul	Human, Mouse,Rat	WB IHC	200ug	59670
CLSDF7839	C1QA Antibody	50ug/50ul ,100ug/100ul	Human, Mouse	WB	200ug	59670
CLSDF7840	GC Antibody	50ug/50ul ,100ug/100ul	Human	WB	200ug	59670
CLSDF7841	GC Antibody	50ug/50ul ,100ug/100ul	Human, Mouse	WB IHC	200ug	59670
CLSDF7842	SYNGAP1 Antibody	50ug/50ul ,100ug/100ul	Human, Mouse,Rat	WB	200ug	59670
CLSDF7843	SLC4A1 Antibody	50ug/50ul ,100ug/100ul	Human	WB	200ug	59670
CLSDF7844	TRIB3 Antibody	50ug/50ul ,100ug/100ul	Human	WB	200ug	59670
CLSDF7845	PABPN1 Antibody	50ug/50ul ,100ug/100ul	Human, Mouse	WB	200ug	59670
CLSDF7846	MCAM Antibody	50ug/50ul ,100ug/100ul	Human, Mouse,Rat	WB	200ug	59670
CLSDF7847	SPTAN1 Antibody	50ug/50ul ,100ug/100ul	Human	WB	200ug	59670
CLSDF7848	CRADD Antibody	50ug/50ul ,100ug/100ul	Human, Mouse,Rat	WB IHC	200ug	59670
CLSDF7849	VTCN1 Antibody	50ug/50ul ,100ug/100ul	Human	WB	200ug	59670
CLSDF7850	NR4A1 Antibody	50ug/50ul ,100ug/100ul	Human, Mouse,Rat	WB	200ug	59670
CLSDF7851	CRYAB Antibody	50ug/50ul ,100ug/100ul	Human,Rat	WB	200ug	59670
CLSDF7852	CUL4B Antibody	50ug/50ul ,100ug/100ul	Human, Mouse,Rat	WB	200ug	59670
CLSDF7853	KHDRBS1 Antibody	50ug/50ul ,100ug/100ul	Human	WB IHC	200ug	59670
CLSDF7854	GNB2 Antibody	50ug/50ul ,100ug/100ul	Human	WB	200ug	59670
CLSDF7855	AGR2 Antibody	50ug/50ul ,100ug/100ul	Human	WB	200ug	59670
CLSDF7856	HTRA2 Antibody	50ug/50ul ,100ug/100ul	Human	WB	200ug	59670
CLSDF7857	CR2 Antibody	50ug/50ul ,100ug/100ul	Human, Mouse,Rat	WB	200ug	59670
CLSDF7858	PRKAR2B Antibody	50ug/50ul ,100ug/100ul	Human, Mouse,Rat	WB	200ug	59670
CLSDF7859	POU2AF1 Antibody	50ug/50ul ,100ug/100ul	Human, Mouse,Rat	WB	200ug	59670
CLSDF7860	FOLH1 Antibody	50ug/50ul ,100ug/100ul	Human	WB	200ug	59670
CLSDF7861	F13A1 Antibody	50ug/50ul ,100ug/100ul	Human	WB IHC	200ug	59670
CLSDF7862	SYN2 Antibody	50ug/50ul ,100ug/100ul	Human, Mouse,Rat	WB	200ug	59670
CLSDF7863	DAPK3 Antibody	50ug/50ul ,100ug/100ul	Human, Mouse,Rat	WB	200ug	59670

Antibodies
HSN : 38220090

Cat#	Product Description	MW	Reactivity	Application	Pack Size	Unit Price
CLSDF7864	MNX1 Antibody	50ug/50ul ,100ug/100ul	Human, Mouse,Rat	WB	200ug	59670
CLSDF7865	FOLH1 Antibody	50ug/50ul ,100ug/100ul	Human, Mouse,Rat	WB	200ug	59670
CLSDF7866	AGR2 Antibody	50ug/50ul ,100ug/100ul	Human	WB	200ug	59670
CLSDF7867	MT-CO2 Antibody	50ug/50ul ,100ug/100ul	Human	WB	200ug	59670
CLSDF7868	HHEX Antibody	50ug/50ul ,100ug/100ul	Human, Mouse	WB	200ug	59670
CLSDF7869	GSTK1 Antibody	50ug/50ul ,100ug/100ul	Human, Mouse,Rat	WB	200ug	59670
CLSDF7870	NDUFAF1 Antibody	50ug/50ul ,100ug/100ul	Human	WB IHC	200ug	59670
CLSDF7871	CAPNS1 Antibody	50ug/50ul ,100ug/100ul	Human	WB IF/ICC	200ug	59670
CLSDF7872	F13A1 Antibody	50ug/50ul ,100ug/100ul	Human, Mouse,Rat	WB	200ug	59670
CLSDF7873	INPP4A Antibody	50ug/50ul ,100ug/100ul	Human, Mouse,Rat	WB	200ug	59670
CLSDF7874	PARVA Antibody	50ug/50ul ,100ug/100ul	Human	WB	200ug	59670
CLSDF7875	GTPBP4 Antibody	50ug/50ul ,100ug/100ul	Human	WB	200ug	59670
CLSDF7876	BAG2 Antibody	50ug/50ul ,100ug/100ul	Human	WB	200ug	59670
CLSDF7877	NRP1 Antibody	50ug/50ul ,100ug/100ul	Human, Mouse,Rat	WB IHC	200ug	59670
CLSDF7878	BAG2 Antibody	50ug/50ul ,100ug/100ul	Human, Mouse,Rat	WB	200ug	59670
CLSDF7879	CALB2 Antibody	50ug/50ul ,100ug/100ul	Human, Mouse,Rat	WB	200ug	59670
CLSDF7880	TPPP Antibody	50ug/50ul ,100ug/100ul	Human	WB	200ug	59670
CLSDF7881	PRKAR2B Antibody	50ug/50ul ,100ug/100ul	Human, Mouse,Rat	WB	200ug	59670
CLSDF7882	CAPNS1 Antibody	50ug/50ul ,100ug/100ul	Human, Mouse,Rat	WB	200ug	59670
CLSDF7883	AP2S1 Antibody	50ug/50ul ,100ug/100ul	Human	WB	200ug	59670
CLSDF7884	NDUFAF1 Antibody	50ug/50ul ,100ug/100ul	Human, Mouse,Rat	WB	200ug	59670
CLSDF7885	TG Antibody	50ug/50ul ,100ug/100ul	Human, Mouse,Rat	WB	200ug	59670
CLSDF7886	TG Antibody	50ug/50ul ,100ug/100ul	Human	WB	200ug	59670
CLSDF7887	DAB2 Antibody	50ug/50ul ,100ug/100ul	Human	WB	200ug	59670
CLSDF7888	H3F3A Antibody	50ug/50ul ,100ug/100ul	Human, Mouse	WB IHC	200ug	59670
CLSDF7889	SULT1A3 Antibody	50ug/50ul ,100ug/100ul	Human	WB	200ug	59670
CLSDF7890	LYZ Antibody	50ug/50ul ,100ug/100ul	Human	WB	200ug	59670
CLSDF7891	CRTC3 Antibody	50ug/50ul ,100ug/100ul	Human, Mouse	WB	200ug	59670
CLSDF7892	HLF Antibody	50ug/50ul ,100ug/100ul	Human	WB IF/ICC	200ug	59670
CLSDF7893	HBA2 Antibody	50ug/50ul ,100ug/100ul	Human	WB IF/ICC	200ug	59670
CLSDF7894	CD2 Antibody	50ug/50ul ,100ug/100ul	Human	WB	200ug	59670
CLSDF7895	FGA Antibody	50ug/50ul ,100ug/100ul	Human	WB IHC	200ug	59670
CLSDF7896	NCAM1 Antibody	50ug/50ul ,100ug/100ul	Human	WB	200ug	59670
CLSDF7897	APBB1IP Antibody	50ug/50ul ,100ug/100ul	Human	WB IHC IF/ICC	200ug	59670
CLSDF7898	NEFM Antibody	50ug/50ul ,100ug/100ul	Human	WB	200ug	59670
CLSDF7899	SAA4 Antibody	50ug/50ul ,100ug/100ul	Human	WB	200ug	59670
CLSDF7900	LRP1 Antibody	50ug/50ul ,100ug/100ul	Human, Mouse,Rat	WB	200ug	59670
CLSDF7901	ENTPD5 Antibody	50ug/50ul ,100ug/100ul	Human	WB	200ug	59670
CLSDF7902	PUM1 Antibody	50ug/50ul ,100ug/100ul	Human	WB	200ug	59670

Antibodies
HSN : 38220090

Cat#	Product Description	MW	Reactivity	Application	Pack Size	Unit Price
CLSDF7903	CITED1 Antibody	50ug/50ul ,100ug/100ul	Human	WB	200ug	59670
CLSDF7904	CAMK2A Antibody	50ug/50ul ,100ug/100ul	Human	WB	200ug	59670
CLSDF7905	APOA2 Antibody	50ug/50ul ,100ug/100ul	Human, Mouse,Rat	WB	200ug	59670
CLSDF7906	ROR2 Antibody	50ug/50ul ,100ug/100ul	Human, Mouse	WB IF/ICC	200ug	59670
CLSDF7907	PUM2 Antibody	50ug/50ul ,100ug/100ul	Human, Mouse,Rat	WB	200ug	59670
CLSDF7908	PLN Antibody	50ug/50ul ,100ug/100ul	Human	WB	200ug	59670
CLSDF7909	EYA2 Antibody	50ug/50ul ,100ug/100ul	Human	WB	200ug	59670
CLSDF7910	CD72 Antibody	50ug/50ul ,100ug/100ul	Human, Mouse	WB IHC	200ug	59670
CLSDF7911	MYL2 Antibody	50ug/50ul ,100ug/100ul	Human	WB	200ug	59670
CLSDF7912	APOA2 Antibody	50ug/50ul ,100ug/100ul	Human	WB	200ug	59670
CLSDF7913	WARS Antibody	50ug/50ul ,100ug/100ul	Human, Mouse	WB	200ug	59670
CLSDF7914	POU2AF1 Antibody	50ug/50ul ,100ug/100ul	Human, Mouse	WB	200ug	59670
CLSDF7915	PAX7 Antibody	50ug/50ul ,100ug/100ul	Human	WB	200ug	59670
CLSDF7916	CEND1 Antibody	50ug/50ul ,100ug/100ul	Human, Mouse,Rat	WB	200ug	59670
CLSDF7917	TMPRSS2 Antibody	50ug/50ul ,100ug/100ul	Human	WB	200ug	59670
CLSDF7918	EGLN2 Antibody	50ug/50ul ,100ug/100ul	Human, Mouse,Rat	WB	200ug	59670
CLSDF7919	TPPP Antibody	50ug/50ul ,100ug/100ul	Human, Mouse	WB IF/ICC	200ug	59670
CLSDF7920	C17orf37 Antibody	50ug/50ul ,100ug/100ul	Human	WB	200ug	59670
CLSDF7921	SATB1 Antibody	50ug/50ul ,100ug/100ul	Human, Mouse	WB	200ug	59670
CLSDF7922	SCARF1 Antibody	50ug/50ul ,100ug/100ul	Human, Mouse,Rat	WB	200ug	59670
CLSDF7923	CGB Antibody	50ug/50ul ,100ug/100ul	Human	WB IF/ICC	200ug	59670
CLSDF7924	LPIN1 Antibody	50ug/50ul ,100ug/100ul	Human	WB	200ug	59670
CLSDF7925	CEND1 Antibody	50ug/50ul ,100ug/100ul	Human	WB	200ug	59670
CLSDF7926	SPTAN1 Antibody	50ug/50ul ,100ug/100ul	Human, Mouse,Rat	WB	200ug	59670
CLSDF7927	PCYT1A Antibody	50ug/50ul ,100ug/100ul	Human	WB	200ug	59670
CLSDF7928	AGTR2 Antibody	50ug/50ul ,100ug/100ul	Human	WB	200ug	59670
CLSDF7929	SATB2 Antibody	50ug/50ul ,100ug/100ul	Human	WB	200ug	59670
CLSDF7930	CKB Antibody	50ug/50ul ,100ug/100ul	Human, Mouse,Rat	WB	200ug	59670
CLSDF7931	MSLN Antibody	50ug/50ul ,100ug/100ul	Human	WB	200ug	59670
CLSDF7932	PON1 Antibody	50ug/50ul ,100ug/100ul	Human	WB	200ug	59670
CLSDF7933	PIP Antibody	50ug/50ul ,100ug/100ul	Human, Mouse,Rat	WB	200ug	59670
CLSDF7934	AGR2 Antibody	50ug/50ul ,100ug/100ul	Human	WB	200ug	59670
CLSDF7935	AICDA Antibody	50ug/50ul ,100ug/100ul	Human	WB	200ug	59670
CLSDF7936	AP2S1 Antibody	50ug/50ul ,100ug/100ul	Human, Mouse	WB	200ug	59670
CLSDF7937	ATG12 Antibody	50ug/50ul ,100ug/100ul	Human, Mouse,Rat	WB	200ug	59670
CLSDF7938	AURKC Antibody	50ug/50ul ,100ug/100ul	Human, Mouse,Rat	WB	200ug	59670
CLSDF7939	BACE1 Antibody	50ug/50ul ,100ug/100ul	Human	WB	200ug	59670
CLSDF7940	BAG2 Antibody	50ug/50ul ,100ug/100ul	Human	WB	200ug	59670
CLSDF7941	SLC4A1 Antibody	50ug/50ul ,100ug/100ul	Human	WB	200ug	59670

Antibodies
HSN : 38220090

Cat#	Product Description	MW	Reactivity	Application	Pack Size	Unit Price
CLSDF7942	BRCC3 Antibody	50ug/50ul ,100ug/100ul	Human, Mouse,Rat	WB	200ug	59670
CLSDF7943	CAPN2 Antibody	50ug/50ul ,100ug/100ul	Human, Mouse,Rat	WB	200ug	59670
CLSDF7944	NCAM1 Antibody	50ug/50ul ,100ug/100ul	Human	WB	200ug	59670
CLSDF7945	MCAM Antibody	50ug/50ul ,100ug/100ul	Human	WB	200ug	59670
CLSDF7946	DAB2 Antibody	50ug/50ul ,100ug/100ul	Human	WB	200ug	59670
CLSDF7947	DFFA Antibody	50ug/50ul ,100ug/100ul	Human	WB	200ug	59670
CLSDF7948	EHD1 Antibody	50ug/50ul ,100ug/100ul	Human	WB IHC	200ug	59670
CLSDF7949	ESRRA Antibody	50ug/50ul ,100ug/100ul	Human, Mouse,Rat	WB IHC IF/ICC	200ug	59670
CLSDF7950	FDX1 Antibody	50ug/50ul ,100ug/100ul	Human	WB IF/ICC	200ug	59670
CLSDF7951	GRIA4 Antibody	50ug/50ul ,100ug/100ul	Human, Mouse,Rat	WB	200ug	59670
CLSDF7952	HHEX Antibody	50ug/50ul ,100ug/100ul	Human	WB	200ug	59670
CLSDF7953	INPP4A Antibody	50ug/50ul ,100ug/100ul	Human	WB	200ug	59670
CLSDF7954	LRP6 Antibody	50ug/50ul ,100ug/100ul	Human, Mouse	WB	200ug	59670
CLSDF7955	GRIN2A Antibody	50ug/50ul ,100ug/100ul	Human	WB IHC	200ug	59670
CLSDF7956	ORA1 Antibody	50ug/50ul ,100ug/100ul	Human, Mouse,Rat	WB IHC	200ug	59670
CLSDF7957	RRAGA Antibody	50ug/50ul ,100ug/100ul	Human, Mouse,Rat	WB	200ug	59670
CLSDF7958	RALA Antibody	50ug/50ul ,100ug/100ul	Human	WB	200ug	59670
CLSDF7959	FOLH1 Antibody	50ug/50ul ,100ug/100ul	Human	WB IHC	200ug	59670
CLSDF7960	HRAS Antibody	50ug/50ul ,100ug/100ul	Human, Mouse	WB	200ug	59670
CLSDF7961	RUVBL1 Antibody	50ug/50ul ,100ug/100ul	Human	WB IHC	200ug	59670
CLSDF7962	RUVBL1 Antibody	50ug/50ul ,100ug/100ul	Human	WB	200ug	59670
CLSDF7963	SIX2 Antibody	50ug/50ul ,100ug/100ul	Human, Mouse,Rat	WB	200ug	59670
CLSDF7964	SPTAN1 Antibody	50ug/50ul ,100ug/100ul	Human	WB	200ug	59670
CLSDF7965	SPTAN1 Antibody	50ug/50ul ,100ug/100ul	Human, Mouse	WB	200ug	59670
CLSDF7966	TRPM8 Antibody	50ug/50ul ,100ug/100ul	Human, Mouse,Rat	WB	200ug	59670
CLSDF7967	TUBB Antibody	50ug/50ul ,100ug/100ul	Human, Mouse,Rat	WB	200ug	59670
CLSDF7968	USP18 Antibody	50ug/50ul ,100ug/100ul	Human	WB	200ug	59670
CLSDF7969	YBX1 Antibody	50ug/50ul ,100ug/100ul	Human	WB	200ug	59670
CLSDF7970	DAPK3 Antibody	50ug/50ul ,100ug/100ul	Human	WB	200ug	59670
CLSDF7971	MESDC2 Antibody	50ug/50ul ,100ug/100ul	Human	WB	200ug	59670
CLSDF7972	HLA-B Antibody	50ug/50ul ,100ug/100ul	Human, Mouse,Rat	WB	200ug	59670
CLSDF7973	YBX1 Antibody	50ug/50ul ,100ug/100ul	Human, Mouse,Rat	WB	200ug	59670
CLSDF7974	CTNBL1 Antibody	50ug/50ul ,100ug/100ul	Human, Mouse,Rat	WB	200ug	59670
CLSDF7975	INPP4B Antibody	50ug/50ul ,100ug/100ul	Human	WB	200ug	59670
CLSDF7976	AGT Antibody	50ug/50ul ,100ug/100ul	Human, Mouse	WB	200ug	59670
CLSDF7977	GNB2 Antibody	50ug/50ul ,100ug/100ul	Human, Mouse	WB	200ug	59670
CLSDF7978	PDCD6 Antibody	50ug/50ul ,100ug/100ul	Human	WB	200ug	59670
CLSDF7979	RGS9 Antibody	50ug/50ul ,100ug/100ul	Human, Mouse	WB	200ug	59670
CLSDF7980	ACACB Antibody	50ug/50ul ,100ug/100ul	Human, Mouse	WB	200ug	59670

Antibodies
HSN : 38220090

Cat#	Product Description	MW	Reactivity	Application	Pack Size	Unit Price
CLSDF7981	MBD1 Antibody	50ug/50ul ,100ug/100ul	Human, Mouse,Rat	WB	200ug	59670
CLSDF7982	HIPK2 Antibody	50ug/50ul ,100ug/100ul	Human	WB IHC	200ug	59670
CLSDF7983	SPTAN1 Antibody	50ug/50ul ,100ug/100ul	Human, Mouse,Rat	WB IHC	200ug	59670
CLSDF7984	FGA Antibody	50ug/50ul ,100ug/100ul	Human	WB IHC	200ug	59670
CLSDF7985	CALCA Antibody	50ug/50ul ,100ug/100ul	Human	WB	200ug	59670
CLSDF7986	MXD3 Antibody	50ug/50ul ,100ug/100ul	Human	WB	200ug	59670
CLSDF7987	APOD Antibody	50ug/50ul ,100ug/100ul	Human, Mouse,Rat	WB	200ug	59670
CLSDF7988	FSCN1 Antibody	50ug/50ul ,100ug/100ul	Human, Mouse	WB	200ug	59670
CLSDF7989	MUC16 Antibody	50ug/50ul ,100ug/100ul	Human	WB	200ug	59670
CLSDF7990	ARFRP1 Antibody	50ug/50ul ,100ug/100ul	Human	WB	200ug	59670
CLSDF7991	SLIT2 Antibody	50ug/50ul ,100ug/100ul	Human,Rat	WB	200ug	59670
CLSDF7992	CAB39 Antibody	50ug/50ul ,100ug/100ul	Human	WB	200ug	59670
CLSDF7993	ICAM3 Antibody	50ug/50ul ,100ug/100ul	Human, Mouse	WB	200ug	59670
CLSDF7994	S100A6 Antibody	50ug/50ul ,100ug/100ul	Human, Mouse,Rat	WB	200ug	59670
CLSDF7995	TUBA1B Antibody	50ug/50ul ,100ug/100ul	Human, Mouse,Rat	WB	200ug	59670
CLSDF7996	EGLN2 Antibody	50ug/50ul ,100ug/100ul	Human, Mouse	WB	200ug	59670
CLSDF7997	GRN Antibody	50ug/50ul ,100ug/100ul	Human, Mouse	WB IHC	200ug	59670
CLSDF7998	CKB Antibody	50ug/50ul ,100ug/100ul	Human, Mouse,Rat	WB	200ug	59670
CLSDF7999	BACE1 Antibody	50ug/50ul ,100ug/100ul	Human	WB	200ug	59670
CLSDF8000	ACTN4 Antibody	50ug/50ul ,100ug/100ul	Human, Mouse,Rat	WB IHC	200ug	59670
CLSDF8001	PIP Antibody	50ug/50ul ,100ug/100ul	Human, Mouse,Rat	WB	200ug	59670
CLSDF8002	SATB2 Antibody	50ug/50ul ,100ug/100ul	Human,Rat	WB IHC	200ug	59670
CLSDF8003	FLII Antibody	50ug/50ul ,100ug/100ul	Human	WB	200ug	59670
CLSDF8004	OLIG2 Antibody	50ug/50ul ,100ug/100ul	Human	WB	200ug	59670
CLSDF8005	TERF2 Antibody	50ug/50ul ,100ug/100ul	Human	WB	200ug	59670
CLSDF8006	SULT1A3 Antibody	50ug/50ul ,100ug/100ul	Human	WB	200ug	59670
CLSDF8007	MYL2 Antibody	50ug/50ul ,100ug/100ul	Human	WB	200ug	59670
CLSDF8008	CASQ2 Antibody	50ug/50ul ,100ug/100ul	Human	WB IHC	200ug	59670
CLSDF8009	SOX10 Antibody	50ug/50ul ,100ug/100ul	Human, Mouse,Rat	WB	200ug	59670
CLSDF8010	SATB1 Antibody	50ug/50ul ,100ug/100ul	Human, Mouse,Rat	WB	200ug	59670
CLSDF8011	PSMD14 Antibody	50ug/50ul ,100ug/100ul	Human, Mouse,Rat	WB	200ug	59670
CLSDF8012	ICAM3 Antibody	50ug/50ul ,100ug/100ul	Human, Mouse,Rat	WB	200ug	59670
CLSDF8013	ITGB7 Antibody	50ug/50ul ,100ug/100ul	Human, Mouse	WB	200ug	59670
CLSDF8014	CALB1 Antibody	50ug/50ul ,100ug/100ul	Human, Mouse,Rat	WB IHC	200ug	59670
CLSDF8015	TIRAP Antibody	50ug/50ul ,100ug/100ul	Human	WB	200ug	59670
CLSDF8016	ACTN3 Antibody	50ug/50ul ,100ug/100ul	Human	WB	200ug	59670
CLSDF8017	CASQ2 Antibody	50ug/50ul ,100ug/100ul	Human	WB IHC	200ug	59670
CLSDF8018	SOX18 Antibody	50ug/50ul ,100ug/100ul	Human, Mouse,Rat	WB	200ug	59670
CLSDF8019	HMGB3 Antibody	50ug/50ul ,100ug/100ul	Human	WB IHC	200ug	59670

Antibodies
HSN : 38220090

Cat#	Product Description	MW	Reactivity	Application	Pack Size	Unit Price
CLSDF8020	SMN1 Antibody	50ug/50ul ,100ug/100ul	Human, Mouse,Rat	WB	200ug	59670
CLSDF8021	UBA52 Antibody	50ug/50ul ,100ug/100ul	Human, Mouse	WB	200ug	59670
CLSDF8022	AGT Antibody	50ug/50ul ,100ug/100ul	Human, Mouse,Rat	WB	200ug	59670
CLSDF8023	TNFRSF12A Antibody	50ug/50ul ,100ug/100ul	Human	WB	200ug	59670
CLSDF8024	RBBP7 Antibody	50ug/50ul ,100ug/100ul	Human, Mouse,Rat	WB IHC	200ug	59670
CLSDF8025	GRIA4 Antibody	50ug/50ul ,100ug/100ul	Human, Mouse,Rat	WB IHC	200ug	59670
CLSDF8026	RASGRF1 Antibody	50ug/50ul ,100ug/100ul	Human	WB	200ug	59670
CLSDF8027	KATNA1 Antibody	50ug/50ul ,100ug/100ul	Human, Mouse,Rat	WB	200ug	59670
CLSDF8028	GRIA4 Antibody	50ug/50ul ,100ug/100ul	Human	WB	200ug	59670
CLSDF8029	CEACAM6 Antibody	50ug/50ul ,100ug/100ul	Human, Mouse,Rat	WB	200ug	59670
CLSDF8030	DAPK1 Antibody	50ug/50ul ,100ug/100ul	Human, Mouse,Rat	WB IHC	200ug	59670
CLSDF8031	UBE2L3 Antibody	50ug/50ul ,100ug/100ul	Human	WB	200ug	59670
CLSDF8032	CYP3A5 Antibody	50ug/50ul ,100ug/100ul	Human, Mouse,Rat	WB	200ug	59670
CLSDF8033	GOPC Antibody	50ug/50ul ,100ug/100ul	Human, Mouse	WB	200ug	59670
CLSDF8034	ATG9A Antibody	50ug/50ul ,100ug/100ul	Human, Mouse,Rat	WB	200ug	59670
CLSDF8035	KHDRBS1 Antibody	50ug/50ul ,100ug/100ul	Human	WB	200ug	59670
CLSDF8036	PSMD14 Antibody	50ug/50ul ,100ug/100ul	Human, Mouse,Rat	WB	200ug	59670
CLSDF8037	ACTN4 Antibody	50ug/50ul ,100ug/100ul	Human	WB	200ug	59670
CLSDF8038	FADD Antibody	50ug/50ul ,100ug/100ul	Human	WB	200ug	59670
CLSDF8039	DFFA Antibody	50ug/50ul ,100ug/100ul	Human	WB	200ug	59670
CLSDF8040	DFFA Antibody	50ug/50ul ,100ug/100ul	Human, Mouse,Rat	WB	200ug	59670
CLSDF8041	BCAM Antibody	50ug/50ul ,100ug/100ul	Human, Mouse,Rat	WB	200ug	59670
CLSDF8042	ENTPD5 Antibody	50ug/50ul ,100ug/100ul	Human	WB	200ug	59670
CLSDF8043	SPTAN1 Antibody	50ug/50ul ,100ug/100ul	Human, Mouse,Rat	WB	200ug	59670
CLSDF8044	RUVBL1 Antibody	50ug/50ul ,100ug/100ul	Human, Mouse,Rat	WB	200ug	59670
CLSDF8045	CD81 Antibody	50ug/50ul ,100ug/100ul	Human	WB	200ug	59670
CLSDF8046	CXCR4 Antibody	50ug/50ul ,100ug/100ul	Human	WB	200ug	59670
CLSDF8047	NEUROG2 Antibody	50ug/50ul ,100ug/100ul	Human, Mouse	WB	200ug	59670
CLSDF8048	SYN2 Antibody	50ug/50ul ,100ug/100ul	Human, Mouse,Rat	WB	200ug	59670
CLSDF8049	GPA33 Antibody	50ug/50ul ,100ug/100ul	Human	WB IHC	200ug	59670
CLSDF8050	TRIM29 Antibody	50ug/50ul ,100ug/100ul	Human,Rat	WB IHC	200ug	59670
CLSDF8051	TNC Antibody	50ug/50ul ,100ug/100ul	Human	WB	200ug	59670
CLSDF8052	LY6A Antibody	50ug/50ul ,100ug/100ul	Human, Mouse,Rat	WB	200ug	59670
CLSDF8053	TUBB Antibody	50ug/50ul ,100ug/100ul	Human, Mouse,Rat	WB	200ug	59670
CLSDF8054	APOC3 Antibody	50ug/50ul ,100ug/100ul	Human, Mouse,Rat	WB IHC	200ug	59670
CLSDF8055	EN1 Antibody	50ug/50ul ,100ug/100ul	Human	WB	200ug	59670
CLSDF8056	WARS Antibody	50ug/50ul ,100ug/100ul	Human, Mouse,Rat	WB IHC	200ug	59670
CLSDF8057	UNG Antibody	50ug/50ul ,100ug/100ul	Human	WB IHC	200ug	59670
CLSDF8058	SEMA4D Antibody	50ug/50ul ,100ug/100ul	Human	WB IHC	200ug	59670

Antibodies
HSN : 38220090

Cat#	Product Description	MW	Reactivity	Application	Pack Size	Unit Price
CLSDF8059	LTF Antibody	50ug/50ul ,100ug/100ul	Human	WB	200ug	59670
CLSDF8060	HSPA14 Antibody	50ug/50ul ,100ug/100ul	Human	WB	200ug	59670
CLSDF8061	USP10 Antibody	50ug/50ul ,100ug/100ul	Human, Mouse,Rat	WB	200ug	59670
CLSDF8062	MBNL1 Antibody	50ug/50ul ,100ug/100ul	Human	WB	200ug	59670
CLSDF8063	MYBPC3 Antibody	50ug/50ul ,100ug/100ul	Human	WB	200ug	59670
CLSDF8064	C1QA Antibody	50ug/50ul ,100ug/100ul	Human, Mouse,Rat	WB	200ug	59670
CLSDF8065	SLC7A5 Antibody	50ug/50ul ,100ug/100ul	Human, Mouse	WB	200ug	59670
CLSDF8066	RAD51 Antibody	50ug/50ul ,100ug/100ul	Human, Mouse	WB	200ug	59670
CLSDF8067	WNT2 Antibody	50ug/50ul ,100ug/100ul	Human,Rat	WB	200ug	59670
CLSDF8068	ANXA4 Antibody	50ug/50ul ,100ug/100ul	Human, Mouse	WB IHC	200ug	59670
CLSDF8069	CLSTN1 Antibody	50ug/50ul ,100ug/100ul	Human	WB IHC	200ug	59670
CLSDF8070	AB12 Antibody	50ug/50ul ,100ug/100ul	Human	WB	200ug	59670
CLSDF8071	UBA52 Antibody	50ug/50ul ,100ug/100ul	Human, Mouse	WB	200ug	59670
CLSDF8072	YY1 Antibody	50ug/50ul ,100ug/100ul	Human	WB	200ug	59670
CLSDF8073	ATG4A Antibody	50ug/50ul ,100ug/100ul	Human	WB	200ug	59670
CLSDF8074	EBF1 Antibody	50ug/50ul ,100ug/100ul	Human	WB	200ug	59670
CLSDF8075	FAIM3 Antibody	50ug/50ul ,100ug/100ul	Human, Mouse,Rat	WB	200ug	59670
CLSDF8076	PTP4A2 Antibody	50ug/50ul ,100ug/100ul	Human	WB IHC	200ug	59670
CLSDF8077	TSLP Antibody	50ug/50ul ,100ug/100ul	Human, Mouse	WB	200ug	59670
CLSDF8078	TMPRSS2 Antibody	50ug/50ul ,100ug/100ul	Human	WB IHC	200ug	59670
CLSDF8079	ING3 Antibody	50ug/50ul ,100ug/100ul	Human, Mouse,Rat	WB IHC	200ug	59670
CLSDF8080	PBX3 Antibody	50ug/50ul ,100ug/100ul	Human, Mouse	WB	200ug	59670
CLSDF8081	FRAT1 Antibody	50ug/50ul ,100ug/100ul	Human	WB	200ug	59670
CLSDF8082	MAGEA1 Antibody	50ug/50ul ,100ug/100ul	Human, Mouse	WB IHC	200ug	59670
CLSDF8083	STAMPB Antibody	50ug/50ul ,100ug/100ul	Human, Mouse,Rat	WB	200ug	59670
CLSDF8084	BRCC3 Antibody	50ug/50ul ,100ug/100ul	Human	WB	200ug	59670
CLSDF8085	ING4 Antibody	50ug/50ul ,100ug/100ul	Human	WB	200ug	59670
CLSDF8086	INPP4A Antibody	50ug/50ul ,100ug/100ul	Human, Mouse	WB	200ug	59670
CLSDF8087	TRIP10 Antibody	50ug/50ul ,100ug/100ul	Human, Mouse,Rat	WB	200ug	59670
CLSDF8088	SAA4 Antibody	50ug/50ul ,100ug/100ul	Human	WB	200ug	59670
CLSDF8089	LGALS1 Antibody	50ug/50ul ,100ug/100ul	Human, Mouse,Rat	WB IHC	200ug	59670
CLSDF8090	CEACAM6 Antibody	50ug/50ul ,100ug/100ul	Human	WB	200ug	59670
CLSDF8091	EVL Antibody	50ug/50ul ,100ug/100ul	Human, Mouse,Rat	WB	200ug	59670
CLSDF8092	GRB7 Antibody	50ug/50ul ,100ug/100ul	Human,Rat	WB	200ug	59670
CLSDF8093	TRIP10 Antibody	50ug/50ul ,100ug/100ul	Human, Mouse,Rat	WB	200ug	59670
CLSDF8094	AGT Antibody	50ug/50ul ,100ug/100ul	Human	WB IHC	200ug	59670
CLSDF8095	STIM1 Antibody	50ug/50ul ,100ug/100ul	Human	WB	200ug	59670
CLSDF8096	TYMS Antibody	50ug/50ul ,100ug/100ul	Human	WB	200ug	59670
CLSDF8097	JAG2 Antibody	50ug/50ul ,100ug/100ul	Human	WB	200ug	59670

Antibodies
HSN : 38220090

Cat#	Product Description	MW	Reactivity	Application	Pack Size	Unit Price
CLSDF8098	CD3G Antibody	50ug/50ul ,100ug/100ul	Human, Mouse,Rat	WB	200ug	59670
CLSDF8099	CD3G Antibody	50ug/50ul ,100ug/100ul	Human, Mouse,Rat	WB	200ug	59670
CLSDF8100	GOLM1 Antibody	50ug/50ul ,100ug/100ul	Human, Mouse,Rat	WB	200ug	59670
CLSDF8101	HSPA2 Antibody	50ug/50ul ,100ug/100ul	Human	WB	200ug	59670
CLSDF8102	TERF2 Antibody	50ug/50ul ,100ug/100ul	Human	WB IHC	200ug	59670
CLSDF8103	PFAFH1B1 Antibody	50ug/50ul ,100ug/100ul	Human, Mouse,Rat	WB	200ug	59670
CLSDF8104	CLEC3B Antibody	50ug/50ul ,100ug/100ul	Human, Mouse,Rat	WB	200ug	59670
CLSDF8105	LTF Antibody	50ug/50ul ,100ug/100ul	Human, Mouse,Rat	WB	200ug	59670
CLSDF8106	MFN2 Antibody	50ug/50ul ,100ug/100ul	Human, Mouse,Rat	WB	200ug	59670
CLSDF8107	PYGO2 Antibody	50ug/50ul ,100ug/100ul	Human	WB	200ug	59670
CLSDF8108	PON3 Antibody	50ug/50ul ,100ug/100ul	Human	WB	200ug	59670
CLSDF8109	RSF1 Antibody	50ug/50ul ,100ug/100ul	Human, Mouse	WB	200ug	59670
CLSDF8110	P4HTM Antibody	50ug/50ul ,100ug/100ul	Human, Mouse,Rat	WB	200ug	59670
CLSDF8111	XDH Antibody	50ug/50ul ,100ug/100ul	Human	WB IHC	200ug	59670
CLSDF8112	PIK3CD Antibody	50ug/50ul ,100ug/100ul	Human	WB IF/ICC	200ug	59670
CLSDF8113	CITED2 Antibody	50ug/50ul ,100ug/100ul	Human, Mouse,Rat	WB	200ug	59670
CLSDF8114	CITED4 Antibody	50ug/50ul ,100ug/100ul	Human, Mouse,Rat	WB	200ug	59670
CLSDF8115	NEUROG2 Antibody	50ug/50ul ,100ug/100ul	Human	WB	200ug	59670
CLSDF8116	PKMYT1 Antibody	50ug/50ul ,100ug/100ul	Human	WB	200ug	59670
CLSDF8117	KCNJ2 Antibody	50ug/50ul ,100ug/100ul	Human	WB	200ug	59670
CLSDF8118	FDPS Antibody	50ug/50ul ,100ug/100ul	Human, Mouse,Rat	WB IHC	200ug	59670
CLSDF8119	YY1 Antibody	50ug/50ul ,100ug/100ul	Human, Mouse,Rat	WB	200ug	59670
CLSDF8120	PLK4 Antibody	50ug/50ul ,100ug/100ul	Human, Mouse,Rat	WB	200ug	59670
CLSDF8121	FDFT1 Antibody	50ug/50ul ,100ug/100ul	Human	WB	200ug	59670
CLSDF8122	ARF1 Antibody	50ug/50ul ,100ug/100ul	Human, Mouse,Rat	WB	200ug	59670
CLSDF8123	GOPC Antibody	50ug/50ul ,100ug/100ul	Human, Mouse,Rat	WB	200ug	59670
CLSDF8124	FOXA1 Antibody	50ug/50ul ,100ug/100ul	Human	WB	200ug	59670
CLSDF8125	FNTA Antibody	50ug/50ul ,100ug/100ul	Human, Mouse,Rat	WB	200ug	59670
CLSDF8126	PIP4K2A Antibody	50ug/50ul ,100ug/100ul	Human, Mouse,Rat	WB	200ug	59670
CLSDF8127	MT-CO2 Antibody	50ug/50ul ,100ug/100ul	Human	WB	200ug	59670
CLSDF8128	LYZ Antibody	50ug/50ul ,100ug/100ul	Human	WB	200ug	59670
CLSDF8129	RNLS Antibody	50ug/50ul ,100ug/100ul	Human, Mouse	WB IHC	200ug	59670
CLSDF8130	PTS Antibody	50ug/50ul ,100ug/100ul	Human	WB	200ug	59670
CLSDF8131	SMN1 Antibody	50ug/50ul ,100ug/100ul	Human	WB	200ug	59670
CLSDF8132	CDH4 Antibody	50ug/50ul ,100ug/100ul	Human, Mouse	WB	200ug	59670
CLSDF8133	SOCS2 Antibody	50ug/50ul ,100ug/100ul	Human	WB IF/ICC	200ug	59670
CLSDF8134	ABAT Antibody	50ug/50ul ,100ug/100ul	Human	WB IF/ICC	200ug	59670
CLSDF8135	P2RX7 Antibody	50ug/50ul ,100ug/100ul	Human	WB	200ug	59670
CLSDF8136	SEP15 Antibody	50ug/50ul ,100ug/100ul	Human	WB IHC	200ug	59670

Antibodies
HSN : 38220090

Cat#	Product Description	MW	Reactivity	Application	Pack Size	Unit Price
CLSDF8137	TRAPPC2 Antibody	50ug/50ul ,100ug/100ul	Human	WB	200ug	59670
CLSDF8138	PNPLA2 Antibody	50ug/50ul ,100ug/100ul	Human	WB IHC IF/ICC	200ug	59670
CLSDF8139	OXT Antibody	50ug/50ul ,100ug/100ul	Human	WB	200ug	59670
CLSDF8140	S100A13 Antibody	50ug/50ul ,100ug/100ul	Human	WB	200ug	59670
CLSDF8141	IRS2 Antibody	50ug/50ul ,100ug/100ul	Human, Mouse,Rat	WB	200ug	59670
CLSDF8142	MCAM Antibody	50ug/50ul ,100ug/100ul	Human	WB	200ug	59670
CLSDF8143	IRF7 Antibody	50ug/50ul ,100ug/100ul	Human	WB	200ug	59670
CLSDF8144	NRG3 Antibody	50ug/50ul ,100ug/100ul	Human	WB	200ug	59670
CLSDF8145	CD80 Antibody	50ug/50ul ,100ug/100ul	Human	WB	200ug	59670
CLSDF8146	FFAR1 Antibody	50ug/50ul ,100ug/100ul	Human, Mouse,Rat	WB	200ug	59670
CLSDF8147	C13orf34 Antibody	50ug/50ul ,100ug/100ul	Human, Mouse	WB IF/ICC	200ug	59670
CLSDF8148	PON3 Antibody	50ug/50ul ,100ug/100ul	Human, Mouse,Rat	WB	200ug	59670
CLSDF8149	MBD2 Antibody	50ug/50ul ,100ug/100ul	Human	WB	200ug	59670
CLSDF8150	HLA-B Antibody	50ug/50ul ,100ug/100ul	Human	WB	200ug	59670
CLSDF8151	PCYT1A Antibody	50ug/50ul ,100ug/100ul	Human, Mouse	WB IHC	200ug	59670
CLSDF8152	UBE2L6 Antibody	50ug/50ul ,100ug/100ul	Human	WB	200ug	59670
CLSDF8153	CD97 Antibody	50ug/50ul ,100ug/100ul	Human	WB	200ug	59670
CLSDF8154	DFFA Antibody	50ug/50ul ,100ug/100ul	Human, Mouse	WB	200ug	59670
CLSDF8155	EHD1 Antibody	50ug/50ul ,100ug/100ul	Human, Mouse	WB	200ug	59670
CLSDF8156	BRCC3 Antibody	50ug/50ul ,100ug/100ul	Human	WB	200ug	59670
CLSDF8157	CD7 Antibody	50ug/50ul ,100ug/100ul	Human, Mouse,Rat	WB	200ug	59670
CLSDF8158	UNC13D Antibody	50ug/50ul ,100ug/100ul	Human	WB	200ug	59670
CLSDF8159	IRS2 Antibody	50ug/50ul ,100ug/100ul	Human, Mouse,Rat	WB	200ug	59670
CLSDF8160	WFDC2 Antibody	50ug/50ul ,100ug/100ul	Human, Mouse	WB IF/ICC	200ug	59670
CLSDF8161	TRIM69 Antibody	50ug/50ul ,100ug/100ul	Human	WB	200ug	59670
CLSDF8162	XDH Antibody	50ug/50ul ,100ug/100ul	Human, Mouse	WB	200ug	59670
CLSDF8163	BNIP3L Antibody	50ug/50ul ,100ug/100ul	Human, Mouse,Rat	WB	200ug	59670
CLSDF8164	DAPK2 Antibody	50ug/50ul ,100ug/100ul	Human	WB IF/ICC	200ug	59670
CLSDF8165	LRP6 Antibody	50ug/50ul ,100ug/100ul	Human	WB	200ug	59670
CLSDF8166	MSLN Antibody	50ug/50ul ,100ug/100ul	Human	WB	200ug	59670
CLSDF8167	LCAT Antibody	50ug/50ul ,100ug/100ul	Human, Mouse,Rat	WB	200ug	59670
CLSDF8168	PI4KB Antibody	50ug/50ul ,100ug/100ul	Human	WB	200ug	59670
CLSDF8169	CALB2 Antibody	50ug/50ul ,100ug/100ul	Human	WB	200ug	59670
CLSDF8170	IGHG1 Antibody	50ug/50ul ,100ug/100ul	Human	WB	200ug	59670
CLSDF8171	CDT1 Antibody	50ug/50ul ,100ug/100ul	Human, Mouse,Rat	WB	200ug	59670
CLSDF8172	ORAI1 Antibody	50ug/50ul ,100ug/100ul	Human	WB	200ug	59670
CLSDF8173	PRKAA2 Antibody	50ug/50ul ,100ug/100ul	Human	WB	200ug	59670
CLSDF8174	A2M Antibody	50ug/50ul ,100ug/100ul	Human, Mouse,Rat	WB	200ug	59670
CLSDF8175	NR2C2 Antibody	50ug/50ul ,100ug/100ul	Human	WB	200ug	59670

Antibodies
HSN : 38220090

Cat#	Product Description	MW	Reactivity	Application	Pack Size	Unit Price
CLSDF8176	A2M Antibody	50ug/50ul ,100ug/100ul	Human	WB	200ug	59670
CLSDF8177	UFM1 Antibody	50ug/50ul ,100ug/100ul	Human, Mouse	WB	200ug	59670
CLSDF8178	TRPM8 Antibody	50ug/50ul ,100ug/100ul	Human, Mouse,Rat	WB	200ug	59670
CLSDF8179	IRF9 Antibody	50ug/50ul ,100ug/100ul	Human, Mouse,Rat	WB	200ug	59670
CLSDF8180	ATG12 Antibody	50ug/50ul ,100ug/100ul	Human	WB	200ug	59670
CLSDF8181	CARD11 Antibody	50ug/50ul ,100ug/100ul	Human	WB	200ug	59670
CLSDF8182	ATG12 Antibody	50ug/50ul ,100ug/100ul	Human	WB	200ug	59670
CLSDF8183	ZBTB33 Antibody	50ug/50ul ,100ug/100ul	Human, Mouse,Rat	WB	200ug	59670
CLSDF8184	EHD1 Antibody	50ug/50ul ,100ug/100ul	Human, Mouse,Rat	WB	200ug	59670
CLSDF8185	FDX1 Antibody	50ug/50ul ,100ug/100ul	Human	WB	200ug	59670
CLSDF8186	SIX2 Antibody	50ug/50ul ,100ug/100ul	Human	WB	200ug	59670
CLSDF8187	ICAM3 Antibody	50ug/50ul ,100ug/100ul	Human	WB	200ug	59670
CLSDF8188	BNIP3 Antibody	50ug/50ul ,100ug/100ul	Human	WB	200ug	59670
CLSDF8189	BGN Antibody	50ug/50ul ,100ug/100ul	Human	WB IHC	200ug	59670
CLSDF8190	XPO4 Antibody	50ug/50ul ,100ug/100ul	Human, Mouse,Rat	WB IHC IF/ICC	200ug	59670
CLSDF8191	NUDC Antibody	50ug/50ul ,100ug/100ul	Human	WB IF/ICC	200ug	59670
CLSDF8192	RBBP7 Antibody	50ug/50ul ,100ug/100ul	Human, Mouse,Rat	WB	200ug	59670
CLSDF8193	UBE2N Antibody	50ug/50ul ,100ug/100ul	Human	WB	200ug	59670
CLSDF8194	ENTPD2 Antibody	50ug/50ul ,100ug/100ul	Human	WB	200ug	59670
CLSDF8195	NETO2 Antibody	50ug/50ul ,100ug/100ul	Human, Mouse	WB	200ug	59670
CLSDF8196	SOX1 Antibody	50ug/50ul ,100ug/100ul	Human	WB IHC	200ug	59670
CLSDF8197	FADD Antibody	50ug/50ul ,100ug/100ul	Human, Mouse,Rat	WB IHC	200ug	59670
CLSDF8198	SENP3 Antibody	50ug/50ul ,100ug/100ul	Human, Mouse,Rat	WB	200ug	59670
CLSDF8199	CHRNA4 Antibody	50ug/50ul ,100ug/100ul	Human	WB	200ug	59670
CLSDF8200	OSR1 Antibody	50ug/50ul ,100ug/100ul	Human	WB IHC	200ug	59670
CLSDF8201	PTRH2 Antibody	50ug/50ul ,100ug/100ul	Human, Mouse	WB	200ug	59670
CLSDF8202	STXBP1 Antibody	50ug/50ul ,100ug/100ul	Human	WB IHC	200ug	59670
CLSDF8203	UCHL5 Antibody	50ug/50ul ,100ug/100ul	Human	WB	200ug	59670
CLSDF8204	CDK5R2 Antibody	50ug/50ul ,100ug/100ul	Human, Mouse,Rat	WB	200ug	59670
CLSDF8205	UGGT1 Antibody	50ug/50ul ,100ug/100ul	Human	WB	200ug	59670
CLSDF8206	TAF9B Antibody	50ug/50ul ,100ug/100ul	Human, Mouse	WB	200ug	59670
CLSDF8207	SCRIB Antibody	50ug/50ul ,100ug/100ul	Human, Mouse,Rat	WB	200ug	59670
CLSDF8208	PLA2G1B Antibody	50ug/50ul ,100ug/100ul	Human, Mouse,Rat	WB	200ug	59670
CLSDF8209	SLC4A1 Antibody	50ug/50ul ,100ug/100ul	Human	WB	200ug	59670
CLSDF8210	CDC6 Antibody	50ug/50ul ,100ug/100ul	Human	WB	200ug	59670
CLSDF8211	FLII Antibody	50ug/50ul ,100ug/100ul	Human	WB	200ug	59670
CLSDF8212	DAZL Antibody	50ug/50ul ,100ug/100ul	Human	WB	200ug	59670
CLSDF8213	MLLT11 Antibody	50ug/50ul ,100ug/100ul	Human, Mouse,Rat	WB	200ug	59670
CLSDF8214	CD48 Antibody	50ug/50ul ,100ug/100ul	Human, Mouse,Rat	WB	200ug	59670

Antibodies
HSN : 38220090

Cat#	Product Description	MW	Reactivity	Application	Pack Size	Unit Price
CLSDF8215	URM1 Antibody	50ug/50ul ,100ug/100ul	Human, Mouse,Rat	WB	200ug	59670
CLSDF8216	ATG3 Antibody	50ug/50ul ,100ug/100ul	Human	WB	200ug	59670
CLSDF8217	NODAL Antibody	50ug/50ul ,100ug/100ul	Human, Mouse	WB	200ug	59670
CLSDF8218	FDX1 Antibody	50ug/50ul ,100ug/100ul	Human, Mouse	WB	200ug	59670
CLSDF8219	ITCH Antibody	50ug/50ul ,100ug/100ul	Human	WB	200ug	59670
CLSDF8220	NUDC Antibody	50ug/50ul ,100ug/100ul	Human, Mouse	WB	200ug	59670
CLSDF8221	UBE2N Antibody	50ug/50ul ,100ug/100ul	Human, Mouse	WB	200ug	59670
CLSDF8222	USP28 Antibody	50ug/50ul ,100ug/100ul	Human, Mouse,Rat	WB	200ug	59670
CLSDF8223	HDLBP Antibody	50ug/50ul ,100ug/100ul	Human	WB IHC	200ug	59670
CLSDF8224	ITCH Antibody	50ug/50ul ,100ug/100ul	Human, Mouse,Rat	WB IHC	200ug	59670
CLSDF8225	S100A2 Antibody	50ug/50ul ,100ug/100ul	Human	WB IHC	200ug	59670
CLSDF8226	SSTR5 Antibody	50ug/50ul ,100ug/100ul	Human	WB	200ug	59670
CLSDF8227	TSPO Antibody	50ug/50ul ,100ug/100ul	Human	WB	200ug	59670
CLSDF8228	PAM Antibody	50ug/50ul ,100ug/100ul	Human, Mouse,Rat	WB	200ug	59670
CLSDF8229	ACTC1 Antibody	50ug/50ul ,100ug/100ul	Human, Mouse	WB	200ug	59670
CLSDF8230	STXBP1 Antibody	50ug/50ul ,100ug/100ul	Human	WB	200ug	59670
CLSDF8231	SLC4A1 Antibody	50ug/50ul ,100ug/100ul	Human	WB	200ug	59670
CLSDF8232	GFPT1 Antibody	50ug/50ul ,100ug/100ul	Human,Rat	WB	200ug	59670
CLSDF8233	ABCA1 Antibody	50ug/50ul ,100ug/100ul	Human	WB	200ug	59670
CLSDF8234	RIPK1 Antibody	50ug/50ul ,100ug/100ul	Human, Mouse	WB	200ug	59670
CLSDF8235	CD163 Antibody	50ug/50ul ,100ug/100ul	Human, Mouse,Rat	WB	200ug	59670
CLSDF8236	MSLN Antibody	50ug/50ul ,100ug/100ul	Human, Mouse,Rat	WB	200ug	59670
CLSDF8237	GBA Antibody	50ug/50ul ,100ug/100ul	Human, Mouse	WB	200ug	59670
CLSDF8238	DUSP3 Antibody	50ug/50ul ,100ug/100ul	Human, Mouse	WB IHC	200ug	59670
CLSDF8239	COPS8 Antibody	50ug/50ul ,100ug/100ul	Human, Mouse,Rat	WB	200ug	59670
CLSDF8240	ING2 Antibody	50ug/50ul ,100ug/100ul	Human	WB	200ug	59670
CLSDF8241	TRAM2 Antibody	50ug/50ul ,100ug/100ul	Human, Mouse,Rat	WB IHC	200ug	59670
CLSDF8242	ATG3 Antibody	50ug/50ul ,100ug/100ul	Human, Mouse,Rat	WB	200ug	59670
CLSDF8243	UBE2M Antibody	50ug/50ul ,100ug/100ul	Human,Rat	WB IHC	200ug	59670
CLSDF8244	SSR1 Antibody	50ug/50ul ,100ug/100ul	Human	WB	200ug	59670
CLSDF8245	TLN2 Antibody	50ug/50ul ,100ug/100ul	Human	WB	200ug	59670
CLSDF8246	CTSS Antibody	50ug/50ul ,100ug/100ul	Human	WB	200ug	59670
CLSDF8247	HTT Antibody	50ug/50ul ,100ug/100ul	Human	WB	200ug	59670
CLSDF8248	EEA1 Antibody	50ug/50ul ,100ug/100ul	Human	WB	200ug	59670
CLSDF8249	OS9 Antibody	50ug/50ul ,100ug/100ul	Human	WB IHC	200ug	59670
CLSDF8250	BCAM Antibody	50ug/50ul ,100ug/100ul	Human, Mouse,Rat	WB	200ug	59670
CLSDF8251	GRK1 Antibody	50ug/50ul ,100ug/100ul	Human, Mouse,Rat	WB	200ug	59670
CLSDF8252	TIMELESS Antibody	50ug/50ul ,100ug/100ul	Human, Mouse,Rat	WB	200ug	59670
CLSDF8253	CD97 Antibody	50ug/50ul ,100ug/100ul	Human, Mouse,Rat	WB	200ug	59670

Antibodies
HSN : 38220090

Cat#	Product Description	MW	Reactivity	Application	Pack Size	Unit Price
CLSDF8254	UNC13D Antibody	50ug/50ul ,100ug/100ul	Human, Mouse	WB	200ug	59670
CLSDF8255	NR2C2 Antibody	50ug/50ul ,100ug/100ul	Human, Mouse,Rat	WB IHC	200ug	59670
CLSDF8256	CDH10 Antibody	50ug/50ul ,100ug/100ul	Human	WB	200ug	59670
CLSDF8257	PPP1R9A Antibody	50ug/50ul ,100ug/100ul	Human	WB	200ug	59670
CLSDF8258	SEPP1 Antibody	50ug/50ul ,100ug/100ul	Human	WB IHC	200ug	59670
CLSDF8259	NEK6 Antibody	50ug/50ul ,100ug/100ul	Human, Mouse,Rat	WB	200ug	59670
CLSDF8260	PNP Antibody	50ug/50ul ,100ug/100ul	Human	WB IHC	200ug	59670
CLSDF8261	MAPKAPK2 Antibody	50ug/50ul ,100ug/100ul	Human, Mouse,Rat	WB	200ug	59670
CLSDF8262	LGALS8 Antibody	50ug/50ul ,100ug/100ul	Human, Mouse	WB	200ug	59670
CLSDF8263	CD53 Antibody	50ug/50ul ,100ug/100ul	Human, Mouse,Rat	WB	200ug	59670
CLSDF8264	UIMC1 Antibody	50ug/50ul ,100ug/100ul	Human	WB	200ug	59670
CLSDF8265	F5 Antibody	50ug/50ul ,100ug/100ul	Human, Mouse,Rat	WB IHC	200ug	59670
CLSDF8266	KIF3A Antibody	50ug/50ul ,100ug/100ul	Human, Mouse,Rat	WB IHC	200ug	59670
CLSDF8267	CD82 Antibody	50ug/50ul ,100ug/100ul	Human	WB	200ug	59670
CLSDF8268	PSMA5 Antibody	50ug/50ul ,100ug/100ul	Human, Mouse,Rat	WB	200ug	59670
CLSDF8269	JAG1 Antibody	50ug/50ul ,100ug/100ul	Human	WB	200ug	59670
CLSDF8270	IFITM3 Antibody	50ug/50ul ,100ug/100ul	Human, Mouse,Rat	WB	200ug	59670
CLSDF8271	SLC9A3R1 Antibody	50ug/50ul ,100ug/100ul	Human, Mouse,Rat	WB IHC	200ug	59670
CLSDF8272	WAPAL Antibody	50ug/50ul ,100ug/100ul	Human	WB	200ug	59670
CLSDF8273	MYOG Antibody	50ug/50ul ,100ug/100ul	Human, Mouse,Rat	WB	200ug	59670
CLSDF8274	PSMA7 Antibody	50ug/50ul ,100ug/100ul	Human, Mouse	WB	200ug	59670
CLSDF8275	RCC1 Antibody	50ug/50ul ,100ug/100ul	Human, Mouse,Rat	WB	200ug	59670
CLSDF8276	MPP1 Antibody	50ug/50ul ,100ug/100ul	Human	WB	200ug	59670
CLSDF8277	NEK6 Antibody	50ug/50ul ,100ug/100ul	Human, Mouse,Rat	WB	200ug	59670
CLSDF8278	ESRP1 Antibody	50ug/50ul ,100ug/100ul	Human	WB	200ug	59670
CLSDF8279	TPO Antibody	50ug/50ul ,100ug/100ul	Human	WB	200ug	59670
CLSDF8280	ORM2 Antibody	50ug/50ul ,100ug/100ul	Human	WB	200ug	59670
CLSDF8281	ITGA2 Antibody	50ug/50ul ,100ug/100ul	Human, Mouse,Rat	WB	200ug	59670
CLSDF8282	TPO Antibody	50ug/50ul ,100ug/100ul	Human, Mouse,Rat	WB	200ug	59670
CLSDF8283	SERPINA6 Antibody	50ug/50ul ,100ug/100ul	Human	WB	200ug	59670
CLSDF8284	TAB3 Antibody	50ug/50ul ,100ug/100ul	Human, Mouse,Rat	WB	200ug	59670
CLSDF8285	CDX4 Antibody	50ug/50ul ,100ug/100ul	Human, Mouse,Rat	WB	200ug	59670
CLSDF8286	ENAH Antibody	50ug/50ul ,100ug/100ul	Human	WB	200ug	59670
CLSDF8287	IPO9 Antibody	50ug/50ul ,100ug/100ul	Human	WB	200ug	59670
CLSDF8288	RETN Antibody	50ug/50ul ,100ug/100ul	Human, Mouse	WB	200ug	59670
CLSDF8289	CDC123 Antibody	50ug/50ul ,100ug/100ul	Human, Mouse,Rat	WB	200ug	59670
CLSDF8290	TMOD2 Antibody	50ug/50ul ,100ug/100ul	Human	WB IHC	200ug	59670
CLSDF8291	RAD51 Antibody	50ug/50ul ,100ug/100ul	Human,Rat	WB IHC	200ug	59670
CLSDF8292	S100P Antibody	50ug/50ul ,100ug/100ul	Human	WB	200ug	59670

Antibodies
HSN : 38220090

Cat#	Product Description	MW	Reactivity	Application	Pack Size	Unit Price
CLSDF8293	KIFAP3 Antibody	50ug/50ul ,100ug/100ul	Human, Mouse,Rat	WB	200ug	59670
CLSDF8294	SIRT5 Antibody	50ug/50ul ,100ug/100ul	Human, Mouse,Rat	WB	200ug	59670
CLSDF8295	NR2E1 Antibody	50ug/50ul ,100ug/100ul	Human, Mouse,Rat	WB IHC	200ug	59670
CLSDF8296	TXN Antibody	50ug/50ul ,100ug/100ul	Human	WB	200ug	59670
CLSDF8297	TNPO3 Antibody	50ug/50ul ,100ug/100ul	Human, Mouse,Rat	WB IHC	200ug	59670
CLSDF8298	PSMA5 Antibody	50ug/50ul ,100ug/100ul	Human	WB IHC	200ug	59670
CLSDF8299	WNT16 Antibody	50ug/50ul ,100ug/100ul	Human	WB IHC	200ug	59670
CLSDF8300	TRPM7 Antibody	50ug/50ul ,100ug/100ul	Human	WB	200ug	59670
CLSDF8301	IGHG1 Antibody	50ug/50ul ,100ug/100ul	Human	WB	200ug	59670
CLSDF8302	MYL4 Antibody	50ug/50ul ,100ug/100ul	Human, Mouse,Rat	WB	200ug	59670
CLSDF8303	HPD Antibody	50ug/50ul ,100ug/100ul	Human	WB	200ug	59670
CLSDF8304	BAZ1B Antibody	50ug/50ul ,100ug/100ul	Human	WB	200ug	59670
CLSDF8305	GDF3 Antibody	50ug/50ul ,100ug/100ul	Human, Mouse,Rat	WB	200ug	59670
CLSDF8306	PIK3C3 Antibody	50ug/50ul ,100ug/100ul	Human, Mouse	WB	200ug	59670
CLSDF8307	DCLK1 Antibody	50ug/50ul ,100ug/100ul	Human, Mouse	WB	200ug	59670
CLSDF8308	HRH2 Antibody	50ug/50ul ,100ug/100ul	Human,Rat	WB	200ug	59670
CLSDF8309	PDCD6 Antibody	50ug/50ul ,100ug/100ul	Human, Mouse	WB IHC	200ug	59670
CLSDF8310	PKP3 Antibody	50ug/50ul ,100ug/100ul	Human	WB IHC	200ug	59670
CLSDF8311	HBA2 Antibody	50ug/50ul ,100ug/100ul	Human	WB	200ug	59670
CLSDF8312	DSP Antibody	50ug/50ul ,100ug/100ul	Human, Mouse	WB	200ug	59670
CLSDF8313	PNP Antibody	50ug/50ul ,100ug/100ul	Human	WB	200ug	59670
CLSDF8314	GAP43 Antibody	50ug/50ul ,100ug/100ul	Human	WB	200ug	59670
CLSDF8315	ABCD3 Antibody	50ug/50ul ,100ug/100ul	Human	WB	200ug	59670
CLSDF8316	PANX1 Antibody	50ug/50ul ,100ug/100ul	Human, Mouse,Rat	WB	200ug	59670
CLSDF8317	BACH1 Antibody	50ug/50ul ,100ug/100ul	Human	WB IHC	200ug	59670
CLSDF8318	MYBPC3 Antibody	50ug/50ul ,100ug/100ul	Human, Mouse	WB	200ug	59670
CLSDF8319	IL33 Antibody	50ug/50ul ,100ug/100ul	Human	WB IHC	200ug	59670
CLSDF8320	MPP1 Antibody	50ug/50ul ,100ug/100ul	Human, Mouse,Rat	WB IHC	200ug	59670
CLSDF8321	KRT12 Antibody	50ug/50ul ,100ug/100ul	Human, Mouse	WB	200ug	59670
CLSDF8322	ERN1 Antibody	50ug/50ul ,100ug/100ul	Human	WB	200ug	59670
CLSDF8323	ITGA6 Antibody	50ug/50ul ,100ug/100ul	Human, Mouse	WB IHC	200ug	59670
CLSDF8324	UBE2M Antibody	50ug/50ul ,100ug/100ul	Human, Mouse,Rat	WB	200ug	59670
CLSDF8325	PSMA7 Antibody	50ug/50ul ,100ug/100ul	Human	WB	200ug	59670
CLSDF8326	CAMK2A Antibody	50ug/50ul ,100ug/100ul	Human	WB	200ug	59670
CLSDF8327	ZFYVE9 Antibody	50ug/50ul ,100ug/100ul	Human, Mouse	WB	200ug	59670
CLSDF8328	UCHL5 Antibody	50ug/50ul ,100ug/100ul	Human, Mouse,Rat	WB	200ug	59670
CLSDF8329	HYOU1 Antibody	50ug/50ul ,100ug/100ul	Human	WB	200ug	59670
CLSDF8330	LEFTY2 Antibody	50ug/50ul ,100ug/100ul	Human, Mouse,Rat	WB IHC	200ug	59670
CLSDF8331	MYL4 Antibody	50ug/50ul ,100ug/100ul	Human	WB	200ug	59670

Antibodies
HSN : 38220090

Cat#	Product Description	MW	Reactivity	Application	Pack Size	Unit Price
CLSDF8332	PCYOX1 Antibody	50ug/50ul ,100ug/100ul	Human, Mouse,Rat	WB	200ug	59670
CLSDF8333	NOG Antibody	50ug/50ul ,100ug/100ul	Human,Rat	WB	200ug	59670
CLSDF8334	GRIN2A Antibody	50ug/50ul ,100ug/100ul	Human, Mouse,Rat	WB	200ug	59670
CLSDF8335	RUVBL1 Antibody	50ug/50ul ,100ug/100ul	Human	WB	200ug	59670
CLSDF8336	HPD Antibody	50ug/50ul ,100ug/100ul	Human	WB	200ug	59670
CLSDF8337	BDKRB2 Antibody	50ug/50ul ,100ug/100ul	Human	WB	200ug	59670
CLSDF8338	CD93 Antibody	50ug/50ul ,100ug/100ul	Human, Mouse,Rat	WB	200ug	59670
CLSDF8339	TXNRD1 Antibody	50ug/50ul ,100ug/100ul	Human, Mouse,Rat	WB	200ug	59670
CLSDF8340	MIB1 Antibody	50ug/50ul ,100ug/100ul	Human, Mouse,Rat	WB	200ug	59670
CLSDF8341	SPTBN1 Antibody	50ug/50ul ,100ug/100ul	Human	WB	200ug	59670
CLSDF8342	CARD11 Antibody	50ug/50ul ,100ug/100ul	Human	WB IHC	200ug	59670
CLSDF8343	IL22 Antibody	50ug/50ul ,100ug/100ul	Human, Mouse,Rat	WB	200ug	59670
CLSDF8344	MYH11 Antibody	50ug/50ul ,100ug/100ul	Human, Mouse,Rat	WB	200ug	59670
CLSDF8345	GDF1 Antibody	50ug/50ul ,100ug/100ul	Human, Mouse,Rat	WB	200ug	59670
CLSDF8346	ATG9A Antibody	50ug/50ul ,100ug/100ul	Human, Mouse,Rat	WB	200ug	59670
CLSDF8347	ERAP1 Antibody	50ug/50ul ,100ug/100ul	Human	WB	200ug	59670
CLSDF8348	TXN Antibody	50ug/50ul ,100ug/100ul	Human	WB	200ug	59670
CLSDF8349	SETD7 Antibody	50ug/50ul ,100ug/100ul	Human, Mouse	WB	200ug	59670
CLSDF8350	ADAM15 Antibody	50ug/50ul ,100ug/100ul	Human, Mouse,Rat	WB	200ug	59670
CLSDF8351	DCTN3 Antibody	50ug/50ul ,100ug/100ul	Human	WB IHC	200ug	59670
CLSDF8352	REM1 Antibody	50ug/50ul ,100ug/100ul	Human	WB IF/ICC	200ug	59670
CLSDF8353	DDIT4 Antibody	50ug/50ul ,100ug/100ul	Human, Mouse,Rat	WB	200ug	59670
CLSDF8354	PLCB3 Antibody	50ug/50ul ,100ug/100ul	Human, Mouse,Rat	WB	200ug	59670
CLSDF8355	C1QTNF2 Antibody	50ug/50ul ,100ug/100ul	Human	WB	200ug	59670
CLSDF8356	FCAR Antibody	50ug/50ul ,100ug/100ul	Human	WB	200ug	59670
CLSDF8357	CAP2 Antibody	50ug/50ul ,100ug/100ul	Human	WB	200ug	59670
CLSDF8358	UBA3 Antibody	50ug/50ul ,100ug/100ul	Human, Mouse,Rat	WB IHC	200ug	59670
CLSDF8359	DUX4 Antibody	50ug/50ul ,100ug/100ul	Human, Mouse,Rat	WB	200ug	59670
CLSDF8360	HLA-DRB1 Antibody	50ug/50ul ,100ug/100ul	Human, Mouse,Rat	WB	200ug	59670
CLSDF8361	MCRS1 Antibody	50ug/50ul ,100ug/100ul	Human	WB	200ug	59670
CLSDF8362	LHX3 Antibody	50ug/50ul ,100ug/100ul	Human, Mouse,Rat	WB	200ug	59670
CLSDF8363	EBI3 Antibody	50ug/50ul ,100ug/100ul	Human, Mouse,Rat	WB	200ug	59670
CLSDF8364	GDF11 Antibody	50ug/50ul ,100ug/100ul	Human	WB	200ug	59670
CLSDF8365	RAD51 Antibody	50ug/50ul ,100ug/100ul	Human, Mouse,Rat	WB	200ug	59670
CLSDF8366	ATG10 Antibody	50ug/50ul ,100ug/100ul	Human, Mouse,Rat	WB	200ug	59670
CLSDF8367	ALOX5AP Antibody	50ug/50ul ,100ug/100ul	Human	WB	200ug	59670
CLSDF8368	MEIS1 Antibody	50ug/50ul ,100ug/100ul	Human	WB	200ug	59670
CLSDF8369	WRN Antibody	50ug/50ul ,100ug/100ul	Human, Mouse	WB IHC	200ug	59670
CLSDF8370	KIFAP3 Antibody	50ug/50ul ,100ug/100ul	Human	WB	200ug	59670

Antibodies
HSN : 38220090

Cat#	Product Description	MW	Reactivity	Application	Pack Size	Unit Price
CLSDF8371	CENPE Antibody	50ug/50ul ,100ug/100ul	Human	WB	200ug	59670
CLSDF8372	S100P Antibody	50ug/50ul ,100ug/100ul	Human, Mouse	WB	200ug	59670
CLSDF8373	SENP2 Antibody	50ug/50ul ,100ug/100ul	Human	WB IF/ICC	200ug	59670
CLSDF8374	CHD5 Antibody	50ug/50ul ,100ug/100ul	Human	WB IF/ICC	200ug	59670
CLSDF8375	COPS7A Antibody	50ug/50ul ,100ug/100ul	Human	WB	200ug	59670
CLSDF8376	COPS7B Antibody	50ug/50ul ,100ug/100ul	Human	WB IHC	200ug	59670
CLSDF8377	RANBP1 Antibody	50ug/50ul ,100ug/100ul	Human	WB	200ug	59670
CLSDF8378	ARL4A Antibody	50ug/50ul ,100ug/100ul	Human	WB IHC IF/ICC	200ug	59670
CLSDF8379	LSS Antibody	50ug/50ul ,100ug/100ul	Human	WB	200ug	59670
CLSDF8380	IL22 Antibody	50ug/50ul ,100ug/100ul	Human	WB	200ug	59670
CLSDF8381	IGF2R Antibody	50ug/50ul ,100ug/100ul	Human, Mouse,Rat	WB	200ug	59670
CLSDF8382	CD209 Antibody	50ug/50ul ,100ug/100ul	Human	WB	200ug	59670
CLSDF8383	SLC1A1 Antibody	50ug/50ul ,100ug/100ul	Human	WB	200ug	59670
CLSDF8384	CCL22 Antibody	50ug/50ul ,100ug/100ul	Human	WB	200ug	59670
CLSDF8385	TMOD2 Antibody	50ug/50ul ,100ug/100ul	Human	WB	200ug	59670
CLSDF8386	COPS7B Antibody	50ug/50ul ,100ug/100ul	Human, Mouse,Rat	WB	200ug	59670
CLSDF8387	CARD9 Antibody	50ug/50ul ,100ug/100ul	Human, Mouse	WB IF/ICC	200ug	59670
CLSDF8388	RANBP1 Antibody	50ug/50ul ,100ug/100ul	Human, Mouse,Rat	WB	200ug	59670
CLSDF8389	PROX1 Antibody	50ug/50ul ,100ug/100ul	Human	WB	200ug	59670
CLSDF8390	MUC2 Antibody	50ug/50ul ,100ug/100ul	Human	WB	200ug	59670
CLSDF8391	FUS Antibody	50ug/50ul ,100ug/100ul	Human, Mouse	WB IHC	200ug	59670
CLSDF8392	RYK Antibody	50ug/50ul ,100ug/100ul	Human	WB	200ug	59670
CLSDF8393	STC1 Antibody	50ug/50ul ,100ug/100ul	Human	WB	200ug	59670
CLSDF8394	AVPR1A Antibody	50ug/50ul ,100ug/100ul	Human, Mouse	WB	200ug	59670
CLSDF8395	MUC2 Antibody	50ug/50ul ,100ug/100ul	Human, Mouse	WB	200ug	59670
CLSDF8396	AKT1S1 Antibody	50ug/50ul ,100ug/100ul	Human	WB	200ug	59670
CLSDF8397	PNLIP Antibody	50ug/50ul ,100ug/100ul	Human, Mouse,Rat	WB	200ug	59670
CLSDF8398	PNLIP Antibody	50ug/50ul ,100ug/100ul	Human	WB	200ug	59670
CLSDF8399	ITGA2 Antibody	50ug/50ul ,100ug/100ul	Human, Mouse,Rat	WB	200ug	59670
CLSDF8400	CAP2 Antibody	50ug/50ul ,100ug/100ul	Human, Mouse	WB IF/ICC	200ug	59670
CLSDF8401	ABCG5 Antibody	50ug/50ul ,100ug/100ul	Human	WB	200ug	59670
CLSDF8402	TPBG Antibody	50ug/50ul ,100ug/100ul	Human, Mouse	WB	200ug	59670
CLSDF8403	SUN2 Antibody	50ug/50ul ,100ug/100ul	Human, Mouse,Rat	WB	200ug	59670
CLSDF8404	CARD9 Antibody	50ug/50ul ,100ug/100ul	Human	WB IF/ICC	200ug	59670
CLSDF8405	TMEFF2 Antibody	50ug/50ul ,100ug/100ul	Human	WB	200ug	59670
CLSDF8406	METAP2 Antibody	50ug/50ul ,100ug/100ul	Human	WB	200ug	59670
CLSDF8407	ENC1 Antibody	50ug/50ul ,100ug/100ul	Human, Mouse,Rat	WB	200ug	59670
CLSDF8408	NUP98 Antibody	50ug/50ul ,100ug/100ul	Human	WB	200ug	59670
CLSDF8409	ZNF217 Antibody	50ug/50ul ,100ug/100ul	Human	WB	200ug	59670

Antibodies
HSN : 38220090

Cat#	Product Description	MW	Reactivity	Application	Pack Size	Unit Price
CLSDF8410	MEMO1 Antibody	50ug/50ul ,100ug/100ul	Human	WB	200ug	59670
CLSDF8411	FABP3 Antibody	50ug/50ul ,100ug/100ul	Human, Mouse,Rat	WB	200ug	59670
CLSDF8412	MYH11 Antibody	50ug/50ul ,100ug/100ul	Human	WB	200ug	59670
CLSDF8413	EPS8 Antibody	50ug/50ul ,100ug/100ul	Human	WB	200ug	59670
CLSDF8414	MYH2 Antibody	50ug/50ul ,100ug/100ul	Human, Mouse,Rat	WB	200ug	59670
CLSDF8415	TIMELESS Antibody	50ug/50ul ,100ug/100ul	Human	WB	200ug	59670
CLSDF8416	SRD5A2 Antibody	50ug/50ul ,100ug/100ul	Human	WB	200ug	59670
CLSDF8417	SSB Antibody	50ug/50ul ,100ug/100ul	Human, Mouse	WB	200ug	59670
CLSDF8418	ING1 Antibody	50ug/50ul ,100ug/100ul	Human, Mouse,Rat	WB	200ug	59670
CLSDF8419	OLIG1 Antibody	50ug/50ul ,100ug/100ul	Human, Mouse,Rat	WB	200ug	59670
CLSDF8420	FUS Antibody	50ug/50ul ,100ug/100ul	Human	WB	200ug	59670
CLSDF8421	FTO Antibody	50ug/50ul ,100ug/100ul	Human	WB	200ug	59670
CLSDF8422	ICOSLG Antibody	50ug/50ul ,100ug/100ul	Human	WB	200ug	59670
CLSDF8423	POT1 Antibody	50ug/50ul ,100ug/100ul	Human, Mouse,Rat	WB	200ug	59670
CLSDF8424	PIK3R4 Antibody	50ug/50ul ,100ug/100ul	Human, Mouse,Rat	WB	200ug	59670
CLSDF8425	GHR Antibody	50ug/50ul ,100ug/100ul	Human	WB	200ug	59670
CLSDF8426	THOC5 Antibody	50ug/50ul ,100ug/100ul	Human	WB	200ug	59670
CLSDF8427	TSG101 Antibody	50ug/50ul ,100ug/100ul	Human	WB	200ug	59670
CLSDF8428	GNRHR Antibody	50ug/50ul ,100ug/100ul	Human	WB	200ug	59670
CLSDF8429	EIF3B Antibody	50ug/50ul ,100ug/100ul	Human	WB IHC	200ug	59670
CLSDF8430	MST1 Antibody	50ug/50ul ,100ug/100ul	Human, Mouse,Rat	WB IHC IF/ICC	200ug	59670
CLSDF8431	DOCK2 Antibody	50ug/50ul ,100ug/100ul	Human	WB IF/ICC	200ug	59670
CLSDF8432	HLA-DRB1 Antibody	50ug/50ul ,100ug/100ul	Human, Mouse,Rat	WB	200ug	59670
CLSDF8433	FOLH1 Antibody	50ug/50ul ,100ug/100ul	Human	WB	200ug	59670
CLSDF8434	CD300A Antibody	50ug/50ul ,100ug/100ul	Human	WB	200ug	59670
CLSDF8435	LIPF Antibody	50ug/50ul ,100ug/100ul	Human, Mouse	WB	200ug	59670
CLSDF8436	MGEA5 Antibody	50ug/50ul ,100ug/100ul	Human	WB IHC	200ug	59670
CLSDF8437	RASSF2 Antibody	50ug/50ul ,100ug/100ul	Human, Mouse,Rat	WB IHC	200ug	59670
CLSDF8438	WNT5B Antibody	50ug/50ul ,100ug/100ul	Human, Mouse,Rat	WB	200ug	59670
CLSDF8439	CENPE Antibody	50ug/50ul ,100ug/100ul	Human	WB	200ug	59670
CLSDF8440	AKT1S1 Antibody	50ug/50ul ,100ug/100ul	Human	WB IHC	200ug	59670
CLSDF8441	IL9 Antibody	50ug/50ul ,100ug/100ul	Human, Mouse	WB	200ug	59670
CLSDF8442	RAE1 Antibody	50ug/50ul ,100ug/100ul	Human	WB IHC	200ug	59670
CLSDF8443	FABP3 Antibody	50ug/50ul ,100ug/100ul	Human	WB	200ug	59670
CLSDF8444	MGLL Antibody	50ug/50ul ,100ug/100ul	Human, Mouse,Rat	WB	200ug	59670
CLSDF8445	TSG101 Antibody	50ug/50ul ,100ug/100ul	Human	WB	200ug	59670
CLSDF8446	KIF3A Antibody	50ug/50ul ,100ug/100ul	Human, Mouse	WB	200ug	59670
CLSDF8447	TMEFF2 Antibody	50ug/50ul ,100ug/100ul	Human, Mouse,Rat	WB	200ug	59670
CLSDF8448	CLPP Antibody	50ug/50ul ,100ug/100ul	Human, Mouse,Rat	WB	200ug	59670

Antibodies
HSN : 38220090

Cat#	Product Description	MW	Reactivity	Application	Pack Size	Unit Price
CLSDF8449	NPC1L1 Antibody	50ug/50ul ,100ug/100ul	Human	WB	200ug	59670
CLSDF8450	EIF3E Antibody	50ug/50ul ,100ug/100ul	Human	WB	200ug	59670
CLSDF8451	ARF5 Antibody	50ug/50ul ,100ug/100ul	Human	WB	200ug	59670
CLSDF8452	SUV39H1 Antibody	50ug/50ul ,100ug/100ul	Human	WB	200ug	59670
CLSDF8453	SUN2 Antibody	50ug/50ul ,100ug/100ul	Human, Mouse,Rat	WB	200ug	59670
CLSDF8454	DLG1 Antibody	50ug/50ul ,100ug/100ul	Human, Mouse,Rat	WB	200ug	59670
CLSDF8455	ABI2 Antibody	50ug/50ul ,100ug/100ul	Human, Mouse,Rat	WB	200ug	59670
CLSDF8456	THOC1 Antibody	50ug/50ul ,100ug/100ul	Human	WB	200ug	59670
CLSDF8457	AKT1S1 Antibody	50ug/50ul ,100ug/100ul	Human, Mouse	WB	200ug	59670
CLSDF8458	HDLBP Antibody	50ug/50ul ,100ug/100ul	Human, Mouse	WB	200ug	59670
CLSDF8459	RXRA Antibody	50ug/50ul ,100ug/100ul	Human	WB	200ug	59670
CLSDF8460	LMAN1 Antibody	50ug/50ul ,100ug/100ul	Human, Mouse	WB	200ug	59670
CLSDF8461	EIF2AK4 Antibody	50ug/50ul ,100ug/100ul	Human, Mouse	WB	200ug	59670
CLSDF8462	SLC9A3R1 Antibody	50ug/50ul ,100ug/100ul	Human, Mouse,Rat	WB	200ug	59670
CLSDF8463	EIF3B Antibody	50ug/50ul ,100ug/100ul	Human	WB IHC	200ug	59670
CLSDF8464	CCL11 Antibody	50ug/50ul ,100ug/100ul	Human, Mouse,Rat	WB IHC	200ug	59670
CLSDF8465	HSPA6 Antibody	50ug/50ul ,100ug/100ul	Human	WB IHC	200ug	59670
CLSDF8466	CCL11 Antibody	50ug/50ul ,100ug/100ul	Human	WB	200ug	59670
CLSDF8467	ETV2 Antibody	50ug/50ul ,100ug/100ul	Human	WB	200ug	59670
CLSDF8468	MYBBP1A Antibody	50ug/50ul ,100ug/100ul	Human, Mouse,Rat	WB	200ug	59670
CLSDF8469	TAT Antibody	50ug/50ul ,100ug/100ul	Human, Mouse	WB	200ug	59670
CLSDF8470	NR5A2 Antibody	50ug/50ul ,100ug/100ul	Human	WB	200ug	59670
CLSDF8471	GSR Antibody	50ug/50ul ,100ug/100ul	Human	WB	200ug	59670
CLSDF8472	TACR2 Antibody	50ug/50ul ,100ug/100ul	Human,Rat	WB	200ug	59670
CLSDF8473	PPP2CA Antibody	50ug/50ul ,100ug/100ul	Human	WB	200ug	59670
CLSDF8474	NRAS Antibody	50ug/50ul ,100ug/100ul	Human, Mouse	WB	200ug	59670
CLSDF8475	FCGR2B Antibody	50ug/50ul ,100ug/100ul	Human, Mouse,Rat	WB	200ug	59670
CLSDF8476	SIRT4 Antibody	50ug/50ul ,100ug/100ul	Human, Mouse,Rat	WB	200ug	59670
CYS0001	Goat Anti-Rabbit IgG (H+L) HRP		Rabbit	WB IHC IF	200ug	59670
CYS0002	Goat Anti-Mouse IgG (H+L) HRP		Mouse	WB IHC IF	200ug	59670
CYT0001	C-Myc-Tag Mouse Monoclonal Antibody	N/A	All	WB	100ug	59670
CYT0002	E2-Tag Mouse Monoclonal Antibody	N/A	ALL	WB	100ug	59670
CYT0003	Flag-Tag Mouse Monoclonal Antibody	N/A	All	WB IHC IF IP	100ug	59670
CYT0004	GAPDH Mouse Monoclonal Antibody	34KD	H, R, M, Mk, Dg, Ch, Hm, Rabbit,Pg	WB	100ug	59670
CYT0005	GFP-Tag Mouse Monoclonal Antibody	N/A	all	WB	100ug	59670
CYT0006	GFP-Tag Rabbit Polyclonal Antibody			WB	100ug	59670
CYT0007	GST-Tag Mouse Monoclonal Antibody	N/A	all	WB	100ug	59670
CYT0008	HA-Tag Mouse Monoclonal Antibody	N/A	all	WB IP IF	100ug	59670
CYT0009	His-Tag Mouse Monoclonal Antibody	N/A	All	WB	100ug	59670
CYT0010	HSV-Tag Mouse Monoclonal Antibody	N/A	All	WB	100ug	59670
CYT0011	KT3-Tag Mouse Monoclonal Antibody	N/A	ALL	WB	100ug	59670
CYT0012	MBP-Tag Mouse Monoclonal Antibody	N/A	All	WB	100ug	59670
CYT0013	mCherry-Tag Mouse Monoclonal Antibody	N/A	All	WB IHC IF/ICC IP	100ug	59670
CYT0015	RFP-Tag Mouse Monoclonal Antibody	N/A	All	WB	100ug	59670
CYT0016	S-Tag Mouse Monoclonal Antibody	N/A	ALL	WB	100ug	59670
CYT0017	Strep II tag Mouse Monoclonal Antibody	N/A	All	WB	100ug	59670
CYT0018	T7-Tag Mouse Monoclonal Antibody	N/A	All	WB	100ug	59670
CYT0020	V5-Tag Mouse Monoclonal Antibody	N/A	All	WB	100ug	59670

Antibodies
HSN : 38220090

Cat#	Product Description	MW	Reactivity	Application	Pack Size	Unit Price
CYT0021	VSV-G-Tag Mouse Monoclonal Antibody	N/A	All	WB	100ug	59670
CYT0022	beta-Actin Mouse Monoclonal Antibody	43KD	Human; Monkey; Mouse; Rat; hamster; Dog; Spodoptera frugiperda; chicken · rabbit.Pg	WB	100ug	59670
CYT0023	beta-Tubulin Mouse Monoclonal Antibody	55KD	H, R, M, Mk, Dg, Ch, Hm, Rb,Sh	WB IHC IF	100ug	59670
CYT0030	Plant-actin Mouse Monoclonal Antibody	43 kd	Arabidopsis, Nicotiana tabacum, Oryza sativa, Hordeum vulgare	WB	100ug	59670
CYT0031	COX IV Mouse Monoclonal Antibody	15 KD	Human, Mouse, Rat	WB	100ug	59670
CYT0032	His-Tag Antibody(HRP conjugated)			WB	100ug	59670
CYT0033	Tubulin alpha Antibody	51 kd	Zebrafish	WB	100ug	59670
CYT0034	Tubulin beta Antibody	55 KD	Zebrafish	WB	100ug	59670
CYT0050	HA-Tag Rabbit pAb	N/A	ALL	WB	100ug	59670
CYT0051	His-Tag Rabbit pAb	N/A	ALL	WB	100ug	59670
CYT0043	GST Tag Rabbit pAb	N/A	All	WB	100ug	59670
CYT0044	Flag-Tag Rabbit pAb	N/A	All	WB	100ug	59670
CYT0045	c-myc Tag Rabbit pAb	N/A	All	WB	100ug	59670
CLSDF2968	TDP43 antibody	43 KD	Human, Mouse, Rat	WB	200ug	59670
CLSDF2969	Phospho-EGFR (Tyr1068) antibody	180 KD	Human, Mouse, Rat	WB	200ug	59670
CLSDF2970	TLR9 antibody	117KD	Human, Mouse, Rat	WB	200ug	59670
CLSDF2971	MS11 antibody	39kDa	Human		200ug	59670
CLSDF2972	Phospho-DRP1 (Ser616) Antibody	82 kDa	Human, Mouse	WB	200ug	59670
CLSDF2973	Phospho-EGF Receptor (Tyr998)	180 KD	Human, Mouse	WB	200ug	59670
CLSDF2974	Phospho-EphA2 (Tyr772) Antibody	108 KD	Human	WB	200ug	59670
CLSDF2975	Phospho-PKM2 (Tyr105) Antibody	58KD	Human, Mouse	WB	200ug	59670
CLSDF2976	Phospho-RSK2 (Tyr529) Antibody	90KD	Human, Mouse	WB	200ug	59670
CLSDF2977	Phospho-53BP1 (Ser25/29) Antibody	220KD	Human, Mouse,Rat	WB	200ug	59670
CLSDF2978	Phospho-53BP1 (Thr543) Antibody	220KD	Human	WB IHC	200ug	59670
CLSDF2979	Phospho-53BP1 (Ser1778) Antibody	220KD	Human, Mouse,Rat	WB IHC	200ug	59670
CLSDF2980	Phospho-DRP1 (Ser637) Antibody	82KD	Human	WB IHC	200ug	59670
CLSDF2981	Phospho-DRP1 (Ser616) Antibody	82KD	Human	WB	200ug	59670
CLSDF2982	Acetyl-alpha-Tubulin (Lys40) Antibody	50KD	Human, Mouse,Rat	WB	200ug	59670
CLSDF2983	Phospho-Beclin-1 (Ser93/96) Antibody	60KD	Human, Mouse,Rat	WB	200ug	59670
CLSDF2984	Phospho-E-Catenin (Ser655/Thr658) Antibody	100KD	Human, Mouse	WB	200ug	59670
CLSDF2985	Phospho-SQSTM1/p62 (Ser403) Antibody	62KD	Human, Mouse,Rat	WB IHC	200ug	59670
CLSDF2986	Phospho-SAMHD1 (Thr592) Antibody	72KD	Human	WB IHC	200ug	59670
CLSDF2987	SAMHD1 Antibody	72KD	Human	WB	200ug	59670
CLSDF2988	Phospho-ATR (Ser428) Antibody	309 KD	Human	WB	200ug	59670
CLSDF2989	Phospho-β-Catenin (Ser33/37/Thr41) Antibody	92KD	Human, Mouse,Rat	WB IHC	200ug	59670
CLSDF2990	Phospho-PP1α (Thr320) Antibody	38KD	Human	WB IHC	200ug	59670
CLSDF2991	PP1α Antibody	38KD	Human	WB	200ug	59670
CLSDF2992	Phospho-p57 Kip2 (Thr310) Antibody	57 KD	Human	WB	200ug	59670
CLSDF2993	p57 Kip2 Antibody	57 KD	Human, Mouse,Rat	WB	200ug	59670
CLSDF2994	Phospho-LRP6 (Ser1490) Antibody	180 KD	Human, Mouse,Rat	WB	200ug	59670
CLSDF2995	LRP6 Antibody	180 KD	Human, Mouse,Rat	WB	200ug	59670
CLSDF2996	Phospho-FADD (Ser194) Antibody	23KD	Human, Mouse,Rat	WB	200ug	59670
CLSDF2997	FADD Antibody	23KD	Human, Mouse,Rat	WB	200ug	59670
CLSDF2998	Phospho-Ack1 (Tyr857/858) Antibody	115KD	Human	WB	200ug	59670
CLSDF2999	Phospho-IP3 Receptor (Ser1756) Antibody	314KD	Human, Mouse,Rat	WB	200ug	59670
CLSDF3000	IP3 Receptor Antibody	314KD	Human, Mouse,Rat	WB	200ug	59670
CLSDF8500	AChR alpha3 Antibody	50ug/50ul ,100ug/100ul	Human, Mouse, Rat	WB	200ug	59670
CLSDF8501	ADM Antibody	50ug/50ul ,100ug/100ul	Human, Mouse, Rat	WB IHC	200ug	59670
CLSDF8502	ALDH3A1 Antibody	50ug/50ul ,100ug/100ul	Human, Rat	WB	200ug	59670
CLSDF8503	Ameloblastin Antibody	50ug/50ul ,100ug/100ul	Human	WB	200ug	59670
CLSDF8504	ASCL1 Antibody	50ug/50ul ,100ug/100ul	Human, Mouse, Rat	WB IHC	200ug	59670
CLSDF8505	ATP5J2 Antibody	50ug/50ul ,100ug/100ul	Human	WB IHC	200ug	59670
CLSDF8506	ATP7A Antibody	50ug/50ul ,100ug/100ul	Human, Mouse, Rat	WB IHC	200ug	59670
CLSDF8507	BMP-8 Antibody	50ug/50ul ,100ug/100ul	Human	WB IHC	200ug	59670
CLSDF8508	BRCAA1 Antibody	50ug/50ul ,100ug/100ul	Human, Mouse, Rat	WB	200ug	59670
CLSDF8509	Brm Antibody	50ug/50ul ,100ug/100ul	Human, Mouse, Rat	WB	200ug	59670
CLSDF8510	Cacna2d1 Antibody	50ug/50ul ,100ug/100ul	Human, Mouse, Rat	WB	200ug	59670

Antibodies
HSN : 38220090

Cat#	Product Description	MW	Reactivity	Application	Pack Size	Unit Price
CLSDF8511	CAD Antibody	50ug/50ul ,100ug/100ul	Human	WB	200ug	59670
CLSDF8512	Calcitonin Antibody	50ug/50ul ,100ug/100ul	Human	WB IHC	200ug	59670
CLSDF8513	Cardiotrophin-1 Antibody	50ug/50ul ,100ug/100ul	Human, Mouse, Rat	WB IHC	200ug	59670
CLSDF8514	Cathepsin H Antibody	50ug/50ul ,100ug/100ul	Human	WB IHC	200ug	59670
CLSDF8515	CCK Antibody	50ug/50ul ,100ug/100ul	Human, Mouse, Rat	WB IHC	200ug	59670
CLSDF8516	CD179b Antibody	50ug/50ul ,100ug/100ul	Human	WB	200ug	59670
CLSDF8517	CD203c Antibody	50ug/50ul ,100ug/100ul	Human, Mouse, Rat	WB	200ug	59670
CLSDF8518	CD24 Antibody	50ug/50ul ,100ug/100ul	Human, Mouse, Rat	WB	200ug	59670
CLSDF8519	CD42b Antibody	50ug/50ul ,100ug/100ul	Human, Mouse	WB	200ug	59670
CLSDF8520	Cdc34 Antibody	50ug/50ul ,100ug/100ul	Human, Mouse, Rat	WB	200ug	59670
CLSDF8521	CHD1L Antibody	50ug/50ul ,100ug/100ul	Human, Mouse	WB	200ug	59670
CLSDF8522	CNP-53 Antibody	50ug/50ul ,100ug/100ul	Human, Mouse, Rat	WB	200ug	59670
CLSDF8523	COLQ Antibody	50ug/50ul ,100ug/100ul	Human, Mouse, Rat	WB	200ug	59670
CLSDF8524	COX10 Antibody	50ug/50ul ,100ug/100ul	Human	WB	200ug	59670
CLSDF8525	CTPS Antibody	50ug/50ul ,100ug/100ul	Human, Mouse, Rat	WB IHC	200ug	59670
CLSDF8526	DDX3 Antibody	50ug/50ul ,100ug/100ul	Human, Mouse	WB	200ug	59670
CLSDF8527	Defensin alpha1 Antibody	50ug/50ul ,100ug/100ul	Human	WB IHC	200ug	59670
CLSDF8528	Defensin alpha3 Antibody	50ug/50ul ,100ug/100ul	Human	WB IHC	200ug	59670
CLSDF8529	Defensin alpha4 Antibody	50ug/50ul ,100ug/100ul	Human	WB IHC	200ug	59670
CLSDF8530	Defensin β1 Antibody	50ug/50ul ,100ug/100ul	Human	WB	200ug	59670
CLSDF8531	Defensin β2 Antibody	50ug/50ul ,100ug/100ul	Human	WB	200ug	59670
CLSDF8532	DIO3 Antibody	50ug/50ul ,100ug/100ul	Human, Mouse, Rat	WB	200ug	59670
CLSDF8533	DP-2 Antibody	50ug/50ul ,100ug/100ul	Human, Mouse, Rat	WB	200ug	59670
CLSDF8534	EAAT1 Antibody	50ug/50ul ,100ug/100ul	Human	WB	200ug	59670
CLSDF8535	EAAT2 Antibody	50ug/50ul ,100ug/100ul	Human, Mouse, Rat	WB	200ug	59670
CLSDF8536	ECP Antibody	50ug/50ul ,100ug/100ul	Human	WB	200ug	59670
CLSDF8537	EF-1β Antibody	50ug/50ul ,100ug/100ul	Human, Mouse, Rat	WB	200ug	59670
CLSDF8538	eIF5A2 Antibody	50ug/50ul ,100ug/100ul	Human, Mouse	WB	200ug	59670
CLSDF8539	Elmo1 Antibody	50ug/50ul ,100ug/100ul	Human, Mouse	WB	200ug	59670
CLSDF8540	ENaC γ Antibody	50ug/50ul ,100ug/100ul	Human, Mouse, Rat	WB	200ug	59670
CLSDF8541	Endo G Antibody	50ug/50ul ,100ug/100ul	Human, Mouse, Rat	WB	200ug	59670
CLSDF8542	ENT1 Antibody	50ug/50ul ,100ug/100ul	Human, Mouse, Rat	WB	200ug	59670
CLSDF8543	EOMES Antibody	50ug/50ul ,100ug/100ul	Human, Mouse	WB	200ug	59670
CLSDF8544	Erbin Antibody	50ug/50ul ,100ug/100ul	Human	WB	200ug	59670
CLSDF8545	Fgl2 Antibody	50ug/50ul ,100ug/100ul	Human	WB	200ug	59670
CLSDF8546	FLT3 Antibody	50ug/50ul ,100ug/100ul	Human, Mouse	WB IHC	200ug	59670
CLSDF8547	FucT-IV Antibody	50ug/50ul ,100ug/100ul	Human	WB IHC	200ug	59670
CLSDF8548	GABAA R alpha1 Antibody	50ug/50ul ,100ug/100ul	Human, Mouse, Rat	WB IHC	200ug	59670
CLSDF8549	GCK Antibody	50ug/50ul ,100ug/100ul	Human, Mouse, Rat	WB	200ug	59670

Antibodies
HSN : 38220090

Cat#	Product Description	MW	Reactivity	Application	Pack Size	Unit Price
CLSDF8550	GCS γ Antibody	50ug/50ul ,100ug/100ul	Human, Mouse, Rat	WB	200ug	59670
CLSDF8551	GCS- α -1 Antibody	50ug/50ul ,100ug/100ul	Human, Mouse, Rat	WB IHC	200ug	59670
CLSDF8552	GCS- β -2 Antibody	50ug/50ul ,100ug/100ul	Human, Mouse, Rat	WB IHC	200ug	59670
CLSDF8553	GnRH I Antibody	50ug/50ul ,100ug/100ul	Human	WB IHC	200ug	59670
CLSDF8554	GRO γ Antibody	50ug/50ul ,100ug/100ul	Human	WB IHC	200ug	59670
CLSDF8555	HES2 Antibody	50ug/50ul ,100ug/100ul	Human, Mouse, Rat	WB	200ug	59670
CLSDF8556	HIC-2 Antibody	50ug/50ul ,100ug/100ul	Human, Mouse	WB	200ug	59670
CLSDF8557	HIF-3 α Antibody	50ug/50ul ,100ug/100ul	Human, Mouse, Rat	WB	200ug	59670
CLSDF8558	HLA Class I Antibody	50ug/50ul ,100ug/100ul	Human	WB	200ug	59670
CLSDF8559	HLA-G Antibody	50ug/50ul ,100ug/100ul	Human	WB	200ug	59670
CLSDF8560	HoxB4 Antibody	50ug/50ul ,100ug/100ul	Human, Mouse	WB	200ug	59670
CLSDF8561	IDH2 Antibody	50ug/50ul ,100ug/100ul	Human, Mouse, Rat	WB	200ug	59670
CLSDF8562	IDH3B Antibody	50ug/50ul ,100ug/100ul	Human, Mouse, Rat	WB	200ug	59670
CLSDF8563	IgA Antibody	50ug/50ul ,100ug/100ul	Human	WB IHC	200ug	59670
CLSDF8564	IGF-I Antibody	50ug/50ul ,100ug/100ul	Human, Mouse, Rat	WB IHC	200ug	59670
CLSDF8565	IL-20R α Antibody	50ug/50ul ,100ug/100ul	Human	WB IHC	200ug	59670
CLSDF8566	IL-32 Antibody	50ug/50ul ,100ug/100ul	Human	WB IHC	200ug	59670
CLSDF8567	IL-4R α Antibody	50ug/50ul ,100ug/100ul	Human, Mouse	WB IHC	200ug	59670
CLSDF8568	Inhibin β -C Antibody	50ug/50ul ,100ug/100ul	Human	WB IHC	200ug	59670
CLSDF8569	Krs-1/2 Antibody	50ug/50ul ,100ug/100ul	Human, Mouse, Rat	WB	200ug	59670
CLSDF8570	MaxiK α Antibody	50ug/50ul ,100ug/100ul	Human, Mouse, Rat	WB IHC	200ug	59670
CLSDF8571	MaxiK β Antibody	50ug/50ul ,100ug/100ul	Human, Mouse, Rat	WB IHC	200ug	59670
CLSDF8572	MIP-1 α Antibody	50ug/50ul ,100ug/100ul	Human	WB IHC	200ug	59670
CLSDF8573	ML-IAP Antibody	50ug/50ul ,100ug/100ul	Human	WB	200ug	59670
CLSDF8574	MYH9 Antibody	50ug/50ul ,100ug/100ul	Human, Mouse, Rat	WB	200ug	59670
CLSDF8575	Na ⁺ CP type II α Antibody	50ug/50ul ,100ug/100ul	Human, Mouse, Rat	WB IHC	200ug	59670
CLSDF8576	Na ⁺ CP type I α Antibody	50ug/50ul ,100ug/100ul	Human, Mouse, Rat	WB	200ug	59670
CLSDF8577	Na ⁺ CP type VIII α Antibody	50ug/50ul ,100ug/100ul	Human, Mouse, Rat	WB	200ug	59670
CLSDF8578	NET-5 Antibody	50ug/50ul ,100ug/100ul	Human, Mouse	WB	200ug	59670
CLSDF8579	Netrin-1 Antibody	50ug/50ul ,100ug/100ul	Human, Mouse, Rat	WB IHC	200ug	59670
CLSDF8580	NMDA ϵ 3 Antibody	50ug/50ul ,100ug/100ul	Human	WB IHC	200ug	59670
CLSDF8581	Nogo A Antibody	50ug/50ul ,100ug/100ul	Human, Mouse, Rat	WB IHC	200ug	59670
CLSDF8582	OAT1 Antibody	50ug/50ul ,100ug/100ul	Human, Mouse, Rat	WB IHC	200ug	59670
CLSDF8583	Ob Antibody	50ug/50ul ,100ug/100ul	Human, Mouse, Rat	WB IHC	200ug	59670
CLSDF8584	OBCAM Antibody	50ug/50ul ,100ug/100ul	Human, Mouse, Rat	WB	200ug	59670
CLSDF8585	OCRL Antibody	50ug/50ul ,100ug/100ul	Human, Mouse	WB	200ug	59670
CLSDF8586	OCT1 Antibody	50ug/50ul ,100ug/100ul	Human	WB	200ug	59670
CLSDF8587	OPA1 Antibody	50ug/50ul ,100ug/100ul	Human, Mouse, Rat	WB	200ug	59670
CLSDF8588	PANK2 Antibody	50ug/50ul ,100ug/100ul	Human	WB	200ug	59670

Antibodies
HSN : 38220090

Cat#	Product Description	MW	Reactivity	Application	Pack Size	Unit Price
CLSDF8589	Pax-9 Antibody	50ug/50ul ,100ug/100ul	Human, Mouse, Rat	WB	200ug	59670
CLSDF8590	PDLIM5 Antibody	50ug/50ul ,100ug/100ul	Human	WB	200ug	59670
CLSDF8591	Pepsin A Antibody	50ug/50ul ,100ug/100ul	Human	WB IHC	200ug	59670
CLSDF8592	PGE synthase Antibody	50ug/50ul ,100ug/100ul	Human, Mouse, Rat	WB	200ug	59670
CLSDF8593	Podocin Antibody	50ug/50ul ,100ug/100ul	Human	WB	200ug	59670
CLSDF8594	PP2A-C alpha/β Antibody	50ug/50ul ,100ug/100ul	Human, Mouse, Rat	WB	200ug	59670
CLSDF8595	Pragmin Antibody	50ug/50ul ,100ug/100ul	Human, Mouse, Rat	WB	200ug	59670
CLSDF8596	Prestin Antibody	50ug/50ul ,100ug/100ul	Human, Mouse, Rat	WB	200ug	59670
CLSDF8597	RAMP1 Antibody	50ug/50ul ,100ug/100ul	Human, Mouse, Rat	WB	200ug	59670
CLSDF8598	RAP1 Antibody	50ug/50ul ,100ug/100ul	Human	WB	200ug	59670
CLSDF8599	RBMS3 Antibody	50ug/50ul ,100ug/100ul	Human, Mouse	WB	200ug	59670
CLSDF8600	RFC3 Antibody	50ug/50ul ,100ug/100ul	Human, Mouse, Rat	WB IHC	200ug	59670
CLSDF8601	RNase III Drosha Antibody	50ug/50ul ,100ug/100ul	Human, Mouse	WB	200ug	59670
CLSDF8602	RPA30 Antibody	50ug/50ul ,100ug/100ul	Human	WB	200ug	59670
CLSDF8603	Rsk-3 Antibody	50ug/50ul ,100ug/100ul	Human, Mouse	WB	200ug	59670
CLSDF8604	SAP 155 Antibody	50ug/50ul ,100ug/100ul	Human, Mouse	WB	200ug	59670
CLSDF8605	Sarcoglycan-β Antibody	50ug/50ul ,100ug/100ul	Human, Mouse	WB IHC	200ug	59670
CLSDF8606	SCOP Antibody	50ug/50ul ,100ug/100ul	Human, Mouse, Rat	WB	200ug	59670
CLSDF8607	Sec23B Antibody	50ug/50ul ,100ug/100ul	Human, Mouse	WB	200ug	59670
CLSDF8608	SEI-1 Antibody	50ug/50ul ,100ug/100ul	Human	WB	200ug	59670
CLSDF8609	SEMA3A Antibody	50ug/50ul ,100ug/100ul	Human, Mouse, Rat	WB IHC	200ug	59670
CLSDF8610	SEMA3C Antibody	50ug/50ul ,100ug/100ul	Human, Mouse, Rat	WB IHC	200ug	59670
CLSDF8611	SEMA3F Antibody	50ug/50ul ,100ug/100ul	Human, Mouse, Rat	WB	200ug	59670
CLSDF8612	SEMA4C Antibody	50ug/50ul ,100ug/100ul	Human	WB	200ug	59670
CLSDF8613	SMYD2 Antibody	50ug/50ul ,100ug/100ul	Human, Mouse, Rat	WB	200ug	59670
CLSDF8614	Sox-11 Antibody	50ug/50ul ,100ug/100ul	Human, Mouse, Rat	WB	200ug	59670
CLSDF8615	SP-B Antibody	50ug/50ul ,100ug/100ul	Human	WB	200ug	59670
CLSDF8616	ST Antibody	50ug/50ul ,100ug/100ul	Human, Mouse, Rat	WB	200ug	59670
CLSDF8617	St3Gal-III Antibody	50ug/50ul ,100ug/100ul	Human, Mouse, Rat	WB	200ug	59670
CLSDF8618	STEAP1 Antibody	50ug/50ul ,100ug/100ul	Human	WB IHC	200ug	59670
CLSDF8619	Synphilin-1 Antibody	50ug/50ul ,100ug/100ul	Human, Mouse	WB IHC	200ug	59670
CLSDF8620	TASK-1 Antibody	50ug/50ul ,100ug/100ul	Human, Mouse, Rat	WB	200ug	59670
CLSDF8621	TCR β Antibody	50ug/50ul ,100ug/100ul	Human	WB	200ug	59670
CLSDF8622	Tensin-1 Antibody	50ug/50ul ,100ug/100ul	Human, Mouse	WB	200ug	59670
CLSDF8623	Tensin-2 Antibody	50ug/50ul ,100ug/100ul	Human, Mouse	WB	200ug	59670
CLSDF8624	TRPV4 Antibody	50ug/50ul ,100ug/100ul	Human, Mouse, Rat	WB	200ug	59670
CLSDF8625	Trypsin-3 Antibody	50ug/50ul ,100ug/100ul	Human	WB	200ug	59670
CLSDF8626	UCP2 Antibody	50ug/50ul ,100ug/100ul	Human, Mouse, Rat	WB IHC	200ug	59670
CLSDF8627	UGT8 Antibody	50ug/50ul ,100ug/100ul	Human, Rat	WB	200ug	59670

Antibodies
HSN : 38220090

Cat#	Product Description	MW	Reactivity	Application	Pack Size	Unit Price
CLSDF8628	VAMP-1/2/3 Antibody	50ug/50ul ,100ug/100ul	Human, Mouse, Rat	WB IHC	200ug	59670
CLSDF8629	V-ATPase D1 Antibody	50ug/50ul ,100ug/100ul	Human, Mouse, Rat	WB	200ug	59670
CLSDF8630	ZFP106 Antibody	50ug/50ul ,100ug/100ul	Human, Mouse	WB	200ug	59670
CLSDF8631	ZFP598 Antibody	50ug/50ul ,100ug/100ul	Human, Mouse	WB	200ug	59670
CLSDF8632	ZO-2 Antibody	50ug/50ul ,100ug/100ul	Human, Mouse, Rat	WB	200ug	59670
CLSDF8633	ACTN1/2/3/4 Antibody	50ug/50ul ,100ug/100ul	Human, Mouse, Rat	WB	200ug	59670
CLSDF8634	ADCK4 Antibody	50ug/50ul ,100ug/100ul	Human, Mouse, Rat	WB	200ug	59670
CLSDF8635	ADORA2B Antibody	50ug/50ul ,100ug/100ul	Human	WB	200ug	59670
CLSDF8636	AIFM2 Antibody	50ug/50ul ,100ug/100ul	Human, Mouse	WB	200ug	59670
CLSDF8637	APC8 Antibody	50ug/50ul ,100ug/100ul	Human, Mouse	WB	200ug	59670
CLSDF8638	A-RAF Antibody	50ug/50ul ,100ug/100ul	Human, Mouse, Rat	WB	200ug	59670
CLSDF8639	AurB/C Antibody	50ug/50ul ,100ug/100ul	Human, Mouse, Rat	WB	200ug	59670
CLSDF8640	AWAT1 Antibody	50ug/50ul ,100ug/100ul	Human	WB	200ug	59670
CLSDF8641	C56D2 Antibody	50ug/50ul ,100ug/100ul	Human	WB	200ug	59670
CLSDF8642	CARD10 Antibody	50ug/50ul ,100ug/100ul	Human, Mouse	WB	200ug	59670
CLSDF8643	CCRL2 Antibody	50ug/50ul ,100ug/100ul	Human	WB	200ug	59670
CLSDF8644	CD2 Tail-binding Antibody	50ug/50ul ,100ug/100ul	Human	WB	200ug	59670
CLSDF8645	CLK4 Antibody	50ug/50ul ,100ug/100ul	Human, Mouse	WB	200ug	59670
CLSDF8646	CNR2 Antibody	50ug/50ul ,100ug/100ul	Human	WB	200ug	59670
CLSDF8647	Cofilin Antibody	50ug/50ul ,100ug/100ul	Human, Mouse, Rat	WB	200ug	59670
CLSDF8648	CTBP2 Antibody	50ug/50ul ,100ug/100ul	Human, Mouse, Rat	WB	200ug	59670
CLSDF8649	DHRS8 Antibody	50ug/50ul ,100ug/100ul	Human	WB	200ug	59670
CLSDF8650	DIL-2 Antibody	50ug/50ul ,100ug/100ul	Human, Mouse	WB IHC	200ug	59670
CLSDF8651	DOK5 Antibody	50ug/50ul ,100ug/100ul	Human, Mouse	WB	200ug	59670
CLSDF8652	EIF4E3 Antibody	50ug/50ul ,100ug/100ul	Human, Mouse, Rat	WB	200ug	59670
CLSDF8653	ELAV2/4 Antibody	50ug/50ul ,100ug/100ul	Human, Mouse, Rat	WB	200ug	59670
CLSDF8654	ELF5 Antibody	50ug/50ul ,100ug/100ul	Human, Mouse	WB	200ug	59670
CLSDF8655	FAF1 Antibody	50ug/50ul ,100ug/100ul	Human, Mouse, Rat	WB	200ug	59670
CLSDF8656	FAKD2 Antibody	50ug/50ul ,100ug/100ul	Human	WB	200ug	59670
CLSDF8657	FZD7 Antibody	50ug/50ul ,100ug/100ul	Human, Mouse	WB	200ug	59670
CLSDF8658	FZD8 Antibody	50ug/50ul ,100ug/100ul	Human, Mouse, Rat	WB	200ug	59670
CLSDF8659	GAS6 Antibody	50ug/50ul ,100ug/100ul	Human	WB IHC	200ug	59670
CLSDF8660	GIT1 Antibody	50ug/50ul ,100ug/100ul	Human, Mouse, Rat	WB IHC	200ug	59670
CLSDF8661	GLCTK Antibody	50ug/50ul ,100ug/100ul	Human, Mouse, Rat	WB IHC	200ug	59670
CLSDF8662	GPR105 Antibody	50ug/50ul ,100ug/100ul	Human, Mouse, Rat	WB	200ug	59670
CLSDF8663	HCN2 Antibody	50ug/50ul ,100ug/100ul	Human, Mouse, Rat	WB	200ug	59670
CLSDF8664	HES6 Antibody	50ug/50ul ,100ug/100ul	Human	WB	200ug	59670
CLSDF8665	Hexokinase-3 Antibody	50ug/50ul ,100ug/100ul	Human	WB	200ug	59670
CLSDF8666	Histone H2B Antibody	50ug/50ul ,100ug/100ul	Human, Mouse	WB IHC	200ug	59670

Antibodies
HSN : 38220090

Cat#	Product Description	MW	Reactivity	Application	Pack Size	Unit Price
CLSDF8667	hnRNP H Antibody	50ug/50ul ,100ug/100ul	Human, Mouse, Rat	WB	200ug	59670
CLSDF8668	Ik3-1 Antibody	50ug/50ul ,100ug/100ul	Human, Mouse	WB	200ug	59670
CLSDF8669	IP6K2 Antibody	50ug/50ul ,100ug/100ul	Human, Mouse, Rat	WB	200ug	59670
CLSDF8670	JTB Antibody	50ug/50ul ,100ug/100ul	Human	WB	200ug	59670
CLSDF8671	KIF20A Antibody	50ug/50ul ,100ug/100ul	Human	WB IHC	200ug	59670
CLSDF8672	KLHL3 Antibody	50ug/50ul ,100ug/100ul	Human	WB IHC	200ug	59670
CLSDF8673	LAMB2 Antibody	50ug/50ul ,100ug/100ul	Human, Mouse, Rat	WB	200ug	59670
CLSDF8674	LEG4 Antibody	50ug/50ul ,100ug/100ul	Human	WB IHC	200ug	59670
CLSDF8675	MAK Antibody	50ug/50ul ,100ug/100ul	Human, Mouse, Rat	WB	200ug	59670
CLSDF8676	MDM1 Antibody	50ug/50ul ,100ug/100ul	Human, Mouse, Rat	WB	200ug	59670
CLSDF8677	MIC1 Antibody	50ug/50ul ,100ug/100ul	Human, Mouse	WB	200ug	59670
CLSDF8678	MRGX4 Antibody	50ug/50ul ,100ug/100ul	Human	WB	200ug	59670
CLSDF8679	NARF Antibody	50ug/50ul ,100ug/100ul	Human	WB	200ug	59670
CLSDF8680	NBEAL1 Antibody	50ug/50ul ,100ug/100ul	Human	WB	200ug	59670
CLSDF8681	NF1 Antibody	50ug/50ul ,100ug/100ul	Human, Mouse, Rat	WB	200ug	59670
CLSDF8682	NFAT3 Antibody	50ug/50ul ,100ug/100ul	Human, Mouse	WB	200ug	59670
CLSDF8683	NOL8 Antibody	50ug/50ul ,100ug/100ul	Human	WB IHC	200ug	59670
CLSDF8684	NOX1 Antibody	50ug/50ul ,100ug/100ul	Human, Mouse	WB	200ug	59670
CLSDF8685	NTR2 Antibody	50ug/50ul ,100ug/100ul	Human, Mouse, Rat	WB	200ug	59670
CLSDF8686	OR10K1/10K2 Antibody	50ug/50ul ,100ug/100ul	Human	WB	200ug	59670
CLSDF8687	OR10X1 Antibody	50ug/50ul ,100ug/100ul	Human	WB	200ug	59670
CLSDF8688	OR13C2/13C9 Antibody	50ug/50ul ,100ug/100ul	Human	WB	200ug	59670
CLSDF8689	OR1D4/5 Antibody	50ug/50ul ,100ug/100ul	Human	WB	200ug	59670
CLSDF8690	OR2A25 Antibody	50ug/50ul ,100ug/100ul	Human	WB	200ug	59670
CLSDF8691	OR2A5/2A14 Antibody	50ug/50ul ,100ug/100ul	Human	WB	200ug	59670
CLSDF8692	OR2T3/34 Antibody	50ug/50ul ,100ug/100ul	Human	WB	200ug	59670
CLSDF8693	OR2T5/2T29 Antibody	50ug/50ul ,100ug/100ul	Human	WB	200ug	59670
CLSDF8694	OR3A2/3 Antibody	50ug/50ul ,100ug/100ul	Human	WB	200ug	59670
CLSDF8695	OR4C12 Antibody	50ug/50ul ,100ug/100ul	Human	WB	200ug	59670
CLSDF8696	OR4K2 Antibody	50ug/50ul ,100ug/100ul	Human	WB	200ug	59670
CLSDF8697	OR4Q3 Antibody	50ug/50ul ,100ug/100ul	Human	WB	200ug	59670
CLSDF8698	OR51G1 Antibody	50ug/50ul ,100ug/100ul	Human	WB	200ug	59670
CLSDF8699	OR5H1 Antibody	50ug/50ul ,100ug/100ul	Human	WB	200ug	59670
CLSDF8700	OR5H6 Antibody	50ug/50ul ,100ug/100ul	Human	WB	200ug	59670
CLSDF8701	OR5M3 Antibody	50ug/50ul ,100ug/100ul	Human	WB	200ug	59670
CLSDF8702	OR5V1 Antibody	50ug/50ul ,100ug/100ul	Human	WB	200ug	59670
CLSDF8703	OR7C2 Antibody	50ug/50ul ,100ug/100ul	Human	WB	200ug	59670
CLSDF8704	OR8B2/B3 Antibody	50ug/50ul ,100ug/100ul	Human	WB	200ug	59670
CLSDF8705	OR9G1 Antibody	50ug/50ul ,100ug/100ul	Human	WB	200ug	59670

Antibodies
HSN : 38220090

Cat#	Product Description	MW	Reactivity	Application	Pack Size	Unit Price
CLSDF8706	PER3 Antibody	50ug/50ul ,100ug/100ul	Human	WB	200ug	59670
CLSDF8707	PIP5K Antibody	50ug/50ul ,100ug/100ul	Human, Mouse	WB	200ug	59670
CLSDF8708	POM121 Antibody	50ug/50ul ,100ug/100ul	Human, Mouse, Rat	WB	200ug	59670
CLSDF8709	Prostate Stem Cell Antigen Antibody	50ug/50ul ,100ug/100ul	Human, Mouse	WB	200ug	59670
CLSDF8710	RAB35 Antibody	50ug/50ul ,100ug/100ul	Human, Mouse, Rat	WB	200ug	59670
CLSDF8711	RASSF4 Antibody	50ug/50ul ,100ug/100ul	Human, Rat	WB	200ug	59670
CLSDF8712	RELT Antibody	50ug/50ul ,100ug/100ul	Human, Mouse	WB	200ug	59670
CLSDF8713	RGPD2/3/4/6/8 Antibody	50ug/50ul ,100ug/100ul	Human	WB	200ug	59670
CLSDF8714	RHPN1 Antibody	50ug/50ul ,100ug/100ul	Human	WB	200ug	59670
CLSDF8715	RIOK3 Antibody	50ug/50ul ,100ug/100ul	Human, Mouse	WB	200ug	59670
CLSDF8716	RMP Antibody	50ug/50ul ,100ug/100ul	Human	WB IHC	200ug	59670
CLSDF8717	RNF19A Antibody	50ug/50ul ,100ug/100ul	Human, Mouse	WB	200ug	59670
CLSDF8718	RPL14 Antibody	50ug/50ul ,100ug/100ul	Human, Mouse, Rat	WB	200ug	59670
CLSDF8719	SLC30A8 Antibody	50ug/50ul ,100ug/100ul	Human	WB	200ug	59670
CLSDF8720	SOX8/9/17/18 Antibody	50ug/50ul ,100ug/100ul	Human, Mouse	WB IHC	200ug	59670
CLSDF8721	SP2 Antibody	50ug/50ul ,100ug/100ul	Human, Mouse	WB	200ug	59670
CLSDF8722	SRPK3 Antibody	50ug/50ul ,100ug/100ul	Human, Mouse, Rat	WB	200ug	59670
CLSDF8723	TAAR3 Antibody	50ug/50ul ,100ug/100ul	Human	WB	200ug	59670
CLSDF8724	TAAR5 Antibody	50ug/50ul ,100ug/100ul	Human	WB	200ug	59670
CLSDF8725	TAL-1 Antibody	50ug/50ul ,100ug/100ul	Human, Mouse	WB	200ug	59670
CLSDF8726	TAS2R43 Antibody	50ug/50ul ,100ug/100ul	Human	WB	200ug	59670
CLSDF8727	TBX15/18 Antibody	50ug/50ul ,100ug/100ul	Human, Mouse	WB IHC	200ug	59670
CLSDF8728	TF3C3 Antibody	50ug/50ul ,100ug/100ul	Human, Mouse	WB	200ug	59670
CLSDF8729	TF3C4 Antibody	50ug/50ul ,100ug/100ul	Human	WB	200ug	59670
CLSDF8730	TMPRSS3 Antibody	50ug/50ul ,100ug/100ul	Human, Mouse	WB	200ug	59670
CLSDF8731	TP53INP1 Antibody	50ug/50ul ,100ug/100ul	Human	WB	200ug	59670
CLSDF8732	TPH2 Antibody	50ug/50ul ,100ug/100ul	Human, Mouse, Rat	WB	200ug	59670
CLSDF8733	UBTD2 Antibody	50ug/50ul ,100ug/100ul	Human, Mouse	WB	200ug	59670
CLSDF8734	ZNF23 Antibody	50ug/50ul ,100ug/100ul	Human	WB	200ug	59670
CLSDF8735	Phospho-CD28 (Tyr218) Antibody	50ug/50ul ,100ug/100ul	Human, Mouse, Rat	WB	200ug	59670
CLSDF8736	Phospho-CK-1 alpha (Tyr294) Antibody	50ug/50ul ,100ug/100ul	Human, Mouse, Rat	WB IHC	200ug	59670
CLSDF8737	Phospho-Ephrin B1/B2/B3 (Tyr324) Antibody	50ug/50ul ,100ug/100ul	Human, Mouse, Rat	WB IHC	200ug	59670
CLSDF8738	Phospho-FANCA (Ser1149) Antibody	50ug/50ul ,100ug/100ul	Human, Mouse, Rat	WB IHC	200ug	59670
CLSDF8739	Phospho-ICK (Tyr159) Antibody	50ug/50ul ,100ug/100ul	Human, Mouse, Rat	WB	200ug	59670
CLSDF8740	Phospho-JIP1 (Thr103) Antibody	50ug/50ul ,100ug/100ul	Human, Mouse, Rat	WB	200ug	59670
CLSDF8741	Phospho-MAP3K1 (Thr1402) Antibody	50ug/50ul ,100ug/100ul	Human, Mouse, Rat	WB IHC	200ug	59670
CLSDF8742	Phospho-OSR1 (Thr185) Antibody	50ug/50ul ,100ug/100ul	Human, Mouse, Rat	WB IHC	200ug	59670
CLSDF8743	Phospho-RSK1/2/3/4 (Ser221/227/S218/232) Antibody	50ug/50ul ,100ug/100ul	Human, Mouse, Rat	WB	200ug	59670
CLSDF8744	Phospho-TIF-IA (Ser649) Antibody	50ug/50ul ,100ug/100ul	Human, Mouse, Rat	WB IHC	200ug	59670

Antibodies
HSN : 38220090

Cat#	Product Description	MW	Reactivity	Application	Pack Size	Unit Price
CLSDF8745	Phospho-WEE1 (Ser642) Antibody	50ug/50ul ,100ug/100ul	Human, Mouse, Rat	WB	200ug	59670
CLSDF8746	ASAP1	50ug/50ul ,100ug/100ul	Human, Mouse, Rat	WB	200ug	59670
CLSDF8747	MT-ND3 Antibody	50ug/50ul ,100ug/100ul	Human, Mouse, Rat	WB	200ug	59670
CLSDF8748	Dystrophin Antibody	50ug/50ul ,100ug/100ul	Human, Mouse, Rat	WB	200ug	59670
CLSDF8749	TGF β Receptor III Antibody	50ug/50ul ,100ug/100ul	Human, Mouse, Rat	WB	200ug	59670
CLSDF8750	Sumo2/3/4 Antibody	50ug/50ul ,100ug/100ul	Human, Mouse, Rat	WB	200ug	59670
CLSDF8751	TGIF2LY Antibody	50ug/50ul ,100ug/100ul	Human	WB IHC	200ug	59670
CLSDF8752	ARI1A Antibody	50ug/50ul ,100ug/100ul	Human, Mouse	WB	200ug	59670
CLSDF8753	CHD1 Antibody	50ug/50ul ,100ug/100ul	Human, Mouse	WB	200ug	59670
CLSDF8754	LSM1 Antibody	50ug/50ul ,100ug/100ul	Human, Mouse	WB	200ug	59670
CLSDF8755	NKRF Antibody	50ug/50ul ,100ug/100ul	Human, Mouse	WB	200ug	59670
CLSDF8756	FOXN1 Antibody	50ug/50ul ,100ug/100ul	Human	WB	200ug	59670
CLSDF8757	SOX12 Antibody	50ug/50ul ,100ug/100ul	Human, Mouse	WB	200ug	59670
CLSDF8758	HOXA2 Antibody	50ug/50ul ,100ug/100ul	Human	WB	200ug	59670
CLSDF8759	PRKAB2 Antibody	50ug/50ul ,100ug/100ul	Human, Mouse, Rat	WB	200ug	59670
CLSDF8760	DYRK3 Antibody	50ug/50ul ,100ug/100ul	Human, Mouse, Rat	WB IHC	200ug	59670
CLSDF8761	MAGEC1 Antibody	50ug/50ul ,100ug/100ul	Human	WB IHC	200ug	59670
CLSDF8762	PITX3 Antibody	50ug/50ul ,100ug/100ul	Human, Mouse, Rat	WB IHC	200ug	59670
CLSDF8763	SAP30 Antibody	50ug/50ul ,100ug/100ul	Human, Mouse	WB	200ug	59670
CLSDF8764	SNAPC5 Antibody	50ug/50ul ,100ug/100ul	Human, Mouse	WB	200ug	59670
CLSDF8765	CDKL5 Antibody	50ug/50ul ,100ug/100ul	Human, Mouse	WB IHC	200ug	59670
CLSDF8766	FSBP Antibody	50ug/50ul ,100ug/100ul	Human, Mouse	WB IHC	200ug	59670
CLSDF8767	DUSP14 Antibody	50ug/50ul ,100ug/100ul	Human, Mouse	WB	200ug	59670
CLSDF8768	ZIC1/2/3/4/5 Antibody	50ug/50ul ,100ug/100ul	Human, Mouse	WB IHC	200ug	59670
CLSDF8769	KLF8 Antibody	50ug/50ul ,100ug/100ul	Human	WB	200ug	59670
CLSDF8770	ANP32D Antibody	50ug/50ul ,100ug/100ul	Human	WB	200ug	59670
CLSDF8771	LDOC1 Antibody	50ug/50ul ,100ug/100ul	Human, Mouse	WB	200ug	59670
CLSDF8772	RECK Antibody	50ug/50ul ,100ug/100ul	Human, Mouse	WB	200ug	59670
CLSDF8773	KITH_HHV11 Antibody	50ug/50ul ,100ug/100ul	Human	WB	200ug	59670
CLSDF8774	KR2_HHV11 Antibody	50ug/50ul ,100ug/100ul	Human	WB IHC	200ug	59670
CLSDF8775	KITH_HHV23 Antibody	50ug/50ul ,100ug/100ul	Human	WB	200ug	59670
CLSDF8776	KR1_HHV11 Antibody	50ug/50ul ,100ug/100ul	Human	WB	200ug	59670
CLSDF8777	HMG14 Antibody	50ug/50ul ,100ug/100ul	Human	WB	200ug	59670
CLSDF8778	KITH_HHV1C Antibody	50ug/50ul ,100ug/100ul	Human	WB	200ug	59670
CLSDF8779	KITH_HHV1S Antibody	50ug/50ul ,100ug/100ul	Human	WB	200ug	59670
CLSDF8780	KITH_VZVD Antibody	50ug/50ul ,100ug/100ul	Human	WB	200ug	59670
CLSDF8781	KR1_VZVD Antibody	50ug/50ul ,100ug/100ul	Human	WB	200ug	59670
CLSDF8782	KR2_VZVD Antibody	50ug/50ul ,100ug/100ul	Human	WB	200ug	59670
CLSDF8783	KITH_VZVE Antibody	50ug/50ul ,100ug/100ul	Human	WB IHC	200ug	59670

Antibodies
HSN : 38220090

Cat#	Product Description	MW	Reactivity	Application	Pack Size	Unit Price
CLSDF8784	GLI-3 Antibody	50ug/50ul ,100ug/100ul	Human, Mouse, Rat	WB IHC	200ug	59670
CLSDF8785	NR2C1 Antibody	50ug/50ul ,100ug/100ul	Human, Mouse, Rat	WB IHC	200ug	59670
CLSDF8786	KR1_HHV2H Antibody	50ug/50ul ,100ug/100ul	Human	WB	200ug	59670
CLSDF8787	KR2_EBV Antibody	50ug/50ul ,100ug/100ul	Human	WB	200ug	59670
CLSDF8788	KITH_VZV7 Antibody	50ug/50ul ,100ug/100ul	Human	WB IHC	200ug	59670
CLSDF8789	KITH_VZVG Antibody	50ug/50ul ,100ug/100ul	Human	WB IHC	200ug	59670
CLSDF8790	GCVK_HCMVA Antibody	50ug/50ul ,100ug/100ul	Human	WB	200ug	59670
CLSDF8791	ZNF7 Antibody	50ug/50ul ,100ug/100ul	Human, Mouse	WB IHC	200ug	59670
CLSDF8792	GCVK_HHV6U Antibody	50ug/50ul ,100ug/100ul	Human	WB	200ug	59670
CLSDF8793	ADRA1D Antibody	50ug/50ul ,100ug/100ul	Human	WB	200ug	59670
CLSDF8794	PPP2R1A Antibody	50ug/50ul ,100ug/100ul	Human, Mouse, Rat	WB	200ug	59670
CLSDF8795	NKTR Antibody	50ug/50ul ,100ug/100ul	Human	WB	200ug	59670
CLSDF8796	p63 MAPK Antibody	50ug/50ul ,100ug/100ul	Human, Mouse	WB	200ug	59670
CLSDF8797	CD52 Antibody	50ug/50ul ,100ug/100ul	Human	WB IHC	200ug	59670
CLSDF8798	Adrenergic Receptor α -1B Antibody	50ug/50ul ,100ug/100ul	Human, Mouse, Rat	WB	200ug	59670
CLSDF8799	MSX1/2 Antibody	50ug/50ul ,100ug/100ul	Human, Mouse, Rat	WB	200ug	59670
CLSDF8800	MAGEA9 Antibody	50ug/50ul ,100ug/100ul	Human	WB	200ug	59670
CLSDF8801	MRP Antibody	50ug/50ul ,100ug/100ul	Human, Mouse, Rat	WB	200ug	59670
CLSDF8802	GCVK_HHV7J Antibody	50ug/50ul ,100ug/100ul	Human	WB	200ug	59670
CLSDF8803	GCVK_HHV6Z Antibody	50ug/50ul ,100ug/100ul	Human	WB	200ug	59670
CLSDF8804	TF2A2 Antibody	50ug/50ul ,100ug/100ul	Human, Mouse, Rat	WB	200ug	59670
CLSDF8805	VSX2 Antibody	50ug/50ul ,100ug/100ul	Human, Mouse	WB	200ug	59670
CLSDF8806	SmD3 Antibody	50ug/50ul ,100ug/100ul	Human, Mouse	WB IHC	200ug	59670
CLSDF8807	SPT4H Antibody	50ug/50ul ,100ug/100ul	Human, Mouse	WB IHC	200ug	59670
CLSDF8808	MAP3K9 Antibody	50ug/50ul ,100ug/100ul	Human, Mouse	WB IHC	200ug	59670
CLSDF8809	MRPS11 Antibody	50ug/50ul ,100ug/100ul	Human	WB	200ug	59670
CLSDF8810	SERF2 Antibody	50ug/50ul ,100ug/100ul	Human, Mouse	WB	200ug	59670
CLSDF8811	ENTK Antibody	50ug/50ul ,100ug/100ul	Human	WB IHC	200ug	59670
CLSDF8812	Basonuclin Antibody	50ug/50ul ,100ug/100ul	Human	WB IHC	200ug	59670
CLSDF8813	AKAP12 Antibody	50ug/50ul ,100ug/100ul	Human	WB	200ug	59670
CLSDF8814	ERCC6 Antibody	50ug/50ul ,100ug/100ul	Human	WB IHC	200ug	59670
CLSDF8815	EMX2 Antibody	50ug/50ul ,100ug/100ul	Human, Mouse	WB	200ug	59670
CLSDF8816	WIT1 Antibody	50ug/50ul ,100ug/100ul	Human	WB	200ug	59670
CLSDF8817	EGR3 Antibody	50ug/50ul ,100ug/100ul	Human, Mouse, Rat	WB	200ug	59670
CLSDF8818	FOX11 Antibody	50ug/50ul ,100ug/100ul	Human, Mouse	WB	200ug	59670
CLSDF8819	TAF10 Antibody	50ug/50ul ,100ug/100ul	Human, Mouse	WB	200ug	59670
CLSDF8820	AKAP6 Antibody	50ug/50ul ,100ug/100ul	Human	WB IHC	200ug	59670
CLSDF8821	COASY Antibody	50ug/50ul ,100ug/100ul	Human, Mouse, Rat	WB	200ug	59670
CLSDF8822	ZBTB17 Antibody	50ug/50ul ,100ug/100ul	Human, Mouse, Rat	WB	200ug	59670

Antibodies
HSN : 38220090

Cat#	Product Description	MW	Reactivity	Application	Pack Size	Unit Price
CLSDF8823	hnRNP A0 Antibody	50ug/50ul ,100ug/100ul	Human, Mouse	WB	200ug	59670
CLSDF8824	SFRS6 Antibody	50ug/50ul ,100ug/100ul	Human, Mouse, Rat	WB	200ug	59670
CLSDF8825	DMP1 Antibody	50ug/50ul ,100ug/100ul	Human	WB	200ug	59670
CLSDF8826	FHL3 Antibody	50ug/50ul ,100ug/100ul	Human, Mouse	WB	200ug	59670
CLSDF8827	MTF1 Antibody	50ug/50ul ,100ug/100ul	Human, Mouse	WB	200ug	59670
CLSDF8828	CCRN4L Antibody	50ug/50ul ,100ug/100ul	Human, Mouse, Rat	WB	200ug	59670
CLSDF8829	SART3 Antibody	50ug/50ul ,100ug/100ul	Human, Mouse	WB IHC	200ug	59670
CLSDF8830	TTF1 Antibody	50ug/50ul ,100ug/100ul	Human	WB IHC	200ug	59670
CLSDF8831	hnRNP E1 Antibody	50ug/50ul ,100ug/100ul	Human, Mouse	WB IHC	200ug	59670
CLSDF8832	TAL2 Antibody	50ug/50ul ,100ug/100ul	Human, Mouse	WB	200ug	59670
CLSDF8833	TPD52L1 Antibody	50ug/50ul ,100ug/100ul	Human, Mouse, Rat	WB	200ug	59670
CLSDF8834	LRRK1 Antibody	50ug/50ul ,100ug/100ul	Human	WB IHC	200ug	59670
CLSDF8835	AGK Antibody	50ug/50ul ,100ug/100ul	Human, Mouse	WB IHC	200ug	59670
CLSDF8836	KKLC1 Antibody	50ug/50ul ,100ug/100ul	Human	WB	200ug	59670
CLSDF8837	CT47A Antibody	50ug/50ul ,100ug/100ul	Human	WB IHC	200ug	59670
CLSDF8838	TENS3 Antibody	50ug/50ul ,100ug/100ul	Human	WB	200ug	59670
CLSDF8839	F111B Antibody	50ug/50ul ,100ug/100ul	Human	WB	200ug	59670
CLSDF8840	PLXDC2 Antibody	50ug/50ul ,100ug/100ul	Human, Mouse	WB	200ug	59670
CLSDF8841	LMTK1 Antibody	50ug/50ul ,100ug/100ul	Human, Mouse	WB	200ug	59670
CLSDF8842	MAP3K15 Antibody	50ug/50ul ,100ug/100ul	Human	WB	200ug	59670
CLSDF8843	TSH1 Antibody	50ug/50ul ,100ug/100ul	Human, Mouse	WB IHC	200ug	59670
CLSDF8844	MOB2 Antibody	50ug/50ul ,100ug/100ul	Human, Mouse	WB	200ug	59670
CLSDF8845	FAKD5 Antibody	50ug/50ul ,100ug/100ul	Human, Mouse	WB	200ug	59670
CLSDF8846	SDCCAG8 Antibody	50ug/50ul ,100ug/100ul	Human, Mouse	WB	200ug	59670
CLSDF8847	HIPK1 Antibody	50ug/50ul ,100ug/100ul	Human, Mouse, Rat	WB	200ug	59670
CLSDF8848	BRSK2 Antibody	50ug/50ul ,100ug/100ul	Human, Mouse, Rat	WB	200ug	59670
CLSDF8849	GSG2 Antibody	50ug/50ul ,100ug/100ul	Human	WB	200ug	59670
CLSDF8850	ZNF230 Antibody	50ug/50ul ,100ug/100ul	Human, Mouse, Rat	WB	200ug	59670
CLSDF8851	TNFAIP8L1 Antibody	50ug/50ul ,100ug/100ul	Human, Mouse	WB	200ug	59670
CLSDF8852	FOG2 Antibody	50ug/50ul ,100ug/100ul	Human, Mouse	WB IHC	200ug	59670
CLSDF8853	LMO7 Antibody	50ug/50ul ,100ug/100ul	Human	WB IHC	200ug	59670
CLSDF8854	MYST4 Antibody	50ug/50ul ,100ug/100ul	Human, Mouse	WB IHC	200ug	59670
CLSDF8855	Histone H1X Antibody	50ug/50ul ,100ug/100ul	Human	WB	200ug	59670
CLSDF8856	IP6K1 Antibody	50ug/50ul ,100ug/100ul	Human, Mouse, Rat	WB	200ug	59670
CLSDF8857	GTF2H4 Antibody	50ug/50ul ,100ug/100ul	Human, Mouse, Rat	WB IHC	200ug	59670
CLSDF8858	PINX1 Antibody	50ug/50ul ,100ug/100ul	Human	WB IHC	200ug	59670
CLSDF8859	ZNF496 Antibody	50ug/50ul ,100ug/100ul	Human, Mouse	WB	200ug	59670
CLSDF8860	TPD52L3 Antibody	50ug/50ul ,100ug/100ul	Human	WB IHC	200ug	59670
CLSDF8861	ALPK3 Antibody	50ug/50ul ,100ug/100ul	Human, Mouse	WB	200ug	59670

Antibodies

HSN : 38220090

Cat#	Product Description	MW	Reactivity	Application	Pack Size	Unit Price
CLSDF8862	ARHGEF17 Antibody	50ug/50ul ,100ug/100ul	Human, Mouse	WB	200ug	59670
CLSDF8863	PSKH2 Antibody	50ug/50ul ,100ug/100ul	Human	WB	200ug	59670
CLSDF8864	AKAP9 Antibody	50ug/50ul ,100ug/100ul	Human	WB	200ug	59670
CLSDF8865	SOX7 Antibody	50ug/50ul ,100ug/100ul	Human, Mouse	WB	200ug	59670
CLSDF8866	SPZ1 Antibody	50ug/50ul ,100ug/100ul	Human	WB IHC	200ug	59670
CLSDF8867	PCDH-X/Y Antibody	50ug/50ul ,100ug/100ul	Human	WB	200ug	59670
CLSDF8868	PKD1/2/3 Antibody	50ug/50ul ,100ug/100ul	Human, Mouse, Rat	WB	200ug	59670
CLSDF8869	9HIV1 Antibody	50ug/50ul ,100ug/100ul	Human	WB	200ug	59670
CLSDF8870	CS061 Antibody	50ug/50ul ,100ug/100ul	Human, Mouse, Rat	WB	200ug	59670
CLSDF8871	ZMAT3 Antibody	50ug/50ul ,100ug/100ul	Human, Mouse	WB	200ug	59670
CLSDF8872	CBX8 Antibody	50ug/50ul ,100ug/100ul	Human, Mouse, Rat	WB	200ug	59670
CLSDF8873	Ubinuclein Antibody	50ug/50ul ,100ug/100ul	Human, Mouse	WB	200ug	59670
CLSDF8874	TSH2 Antibody	50ug/50ul ,100ug/100ul	Human, Mouse	WB	200ug	59670
CLSDF8875	CHRC1 Antibody	50ug/50ul ,100ug/100ul	Human, Mouse	WB IHC	200ug	59670
CLSDF8876	APOBEC3C Antibody	50ug/50ul ,100ug/100ul	Human, Mouse	WB IHC	200ug	59670
CLSDF8877	MBIP1 Antibody	50ug/50ul ,100ug/100ul	Human	WB IHC	200ug	59670
CLSDF8878	BMP2K Antibody	50ug/50ul ,100ug/100ul	Human, Mouse, Rat	WB	200ug	59670
CLSDF8879	BARHL2 Antibody	50ug/50ul ,100ug/100ul	Human, Mouse, Rat	WB	200ug	59670
CLSDF8880	KCIP1 Antibody	50ug/50ul ,100ug/100ul	Human, Mouse, Rat	WB	200ug	59670
CLSDF8881	IBTK Antibody	50ug/50ul ,100ug/100ul	Human	WB	200ug	59670
CLSDF8882	RBPJL Antibody	50ug/50ul ,100ug/100ul	Human, Mouse	WB	200ug	59670
CLSDF8883	CGGBP1 Antibody	50ug/50ul ,100ug/100ul	Human, Mouse	WB IHC	200ug	59670
CLSDF8884	AKAP11 Antibody	50ug/50ul ,100ug/100ul	Human	WB	200ug	59670
CLSDF8885	MKL2 Antibody	50ug/50ul ,100ug/100ul	Human, Mouse	WB	200ug	59670
CLSDF8886	WBP7 Antibody	50ug/50ul ,100ug/100ul	Human, Mouse	WB	200ug	59670
CLSDF8887	TRIM33 Antibody	50ug/50ul ,100ug/100ul	Human, Mouse	WB	200ug	59670
CLSDF8888	TRIM35 Antibody	50ug/50ul ,100ug/100ul	Human	WB	200ug	59670
CLSDF8889	SRRM2 Antibody	50ug/50ul ,100ug/100ul	Human, Mouse	WB	200ug	59670
CLSDF8890	RNF6 Antibody	50ug/50ul ,100ug/100ul	Human	WB	200ug	59670
CLSDF8891	PKIG Antibody	50ug/50ul ,100ug/100ul	Human	WB	200ug	59670
CLSDF8892	MAST1 Antibody	50ug/50ul ,100ug/100ul	Human, Mouse, Rat	WB	200ug	59670
CLSDF8893	THRAP3 Antibody	50ug/50ul ,100ug/100ul	Human, Mouse, Rat	WB	200ug	59670
CLSDF8894	WNK2 Antibody	50ug/50ul ,100ug/100ul	Human, Mouse	WB	200ug	59670
CLSDF8895	MaFb Antibody	50ug/50ul ,100ug/100ul	Human, Mouse, Rat	WB IHC	200ug	59670
CLSDF8896	NCOR2 Antibody	50ug/50ul ,100ug/100ul	Human	WB	200ug	59670
CLSDF8897	SOX21 Antibody	50ug/50ul ,100ug/100ul	Human, Mouse	WB	200ug	59670
CLSDF8898	AK5 Antibody	50ug/50ul ,100ug/100ul	Human, Mouse	WB	200ug	59670
CLSDF8899	ZHX2 Antibody	50ug/50ul ,100ug/100ul	Human, Mouse	WB	200ug	59670
CLSDF8900	5-HT-2A Antibody	50ug/50ul ,100ug/100ul	Human	WB	200ug	59670

Antibodies
HSN : 38220090

Cat#	Product Description	MW	Reactivity	Application	Pack Size	Unit Price
CLSDF8901	Collagen VII α1 Antibody	50ug/50ul ,100ug/100ul	Human, Mouse	WB	200ug	59670
CLSDF8902	Collagen VIII α1 Antibody	50ug/50ul ,100ug/100ul	Human	WB	200ug	59670
CLSDF8903	Collagen VIII α2 Antibody	50ug/50ul ,100ug/100ul	Human, Mouse, Rat	WB	200ug	59670
CLSDF8904	Collagen IX α1 Antibody	50ug/50ul ,100ug/100ul	Human, Mouse	WB	200ug	59670
CLSDF8905	Collagen IX α2 Antibody	50ug/50ul ,100ug/100ul	Human, Mouse	WB	200ug	59670
CLSDF8906	Collagen XVI α1 Antibody	50ug/50ul ,100ug/100ul	Human, Mouse	WB	200ug	59670
CLSDF8907	COX15 Antibody	50ug/50ul ,100ug/100ul	Human, Mouse, Rat	WB	200ug	59670
CLSDF8908	COX5B Antibody	50ug/50ul ,100ug/100ul	Human, Mouse, Rat	WB IHC	200ug	59670
CLSDF8909	Cytochrome P450 2F1 Antibody	50ug/50ul ,100ug/100ul	Human	WB	200ug	59670
CLSDF8910	CD320 Antibody	50ug/50ul ,100ug/100ul	Human, Mouse, Rat	WB	200ug	59670
CLSDF8911	CDK3 Antibody	50ug/50ul ,100ug/100ul	Human, Mouse	WB	200ug	59670
CLSDF8912	CELSR2 Antibody	50ug/50ul ,100ug/100ul	Human, Mouse, Rat	WB	200ug	59670
CLSDF8913	CIDEC Antibody	50ug/50ul ,100ug/100ul	Human	WB	200ug	59670
CLSDF8914	CISH Antibody	50ug/50ul ,100ug/100ul	Human, Mouse, Rat	WB	200ug	59670
CLSDF8915	CDK5RAP1 Antibody	50ug/50ul ,100ug/100ul	Human	WB	200ug	59670
CLSDF8916	CDCA7L Antibody	50ug/50ul ,100ug/100ul	Human	WB	200ug	59670
CLSDF8917	ADCY7 Antibody	50ug/50ul ,100ug/100ul	Human, Mouse	WB IHC	200ug	59670
CLSDF8918	APR2 Antibody	50ug/50ul ,100ug/100ul	Human	WB IHC	200ug	59670
CLSDF8919	ARRS Antibody	50ug/50ul ,100ug/100ul	Human	WB IHC	200ug	59670
CLSDF8920	Cytochrome c Oxidase 1 Antibody	50ug/50ul ,100ug/100ul	Human, Mouse	WB	200ug	59670
CLSDF8921	Cytochrome c Oxidase 3 Antibody	50ug/50ul ,100ug/100ul	Human	WB	200ug	59670
CLSDF8922	Cytochrome P450 27C1 Antibody	50ug/50ul ,100ug/100ul	Human	WB IHC	200ug	59670
CLSDF8923	Cytochrome c Oxidase 7C Antibody	50ug/50ul ,100ug/100ul	Human, Mouse, Rat	WB IHC	200ug	59670
CLSDF8924	Cytochrome c Oxidase 8C Antibody	50ug/50ul ,100ug/100ul	Human, Mouse	WB	200ug	59670
CLSDF8925	CDH26 Antibody	50ug/50ul ,100ug/100ul	Human	WB	200ug	59670
CLSDF8926	Cytochrome P450 46A1 Antibody	50ug/50ul ,100ug/100ul	Human, Mouse	WB	200ug	59670
CLSDF8927	Cytochrome P450 4F3 Antibody	50ug/50ul ,100ug/100ul	Human	WB	200ug	59670
CLSDF8928	Cytochrome P450 4F8 Antibody	50ug/50ul ,100ug/100ul	Human	WB	200ug	59670
CLSDF8929	Cytochrome P450 4F22 Antibody	50ug/50ul ,100ug/100ul	Human	WB	200ug	59670
CLSDF8930	CRLF1 Antibody	50ug/50ul ,100ug/100ul	Human, Mouse	WB IHC	200ug	59670
CLSDF8931	CRLF3 Antibody	50ug/50ul ,100ug/100ul	Human, Mouse	WB	200ug	59670
CLSDF8932	CRY1 Antibody	50ug/50ul ,100ug/100ul	Human, Mouse, Rat	WB	200ug	59670
CLSDF8933	HspB4 Antibody	50ug/50ul ,100ug/100ul	Human, Mouse, Rat	WB	200ug	59670
CLSDF8934	Cytochrome c Oxidase 6A1 Antibody	50ug/50ul ,100ug/100ul	Human, Rat	WB	200ug	59670
CLSDF8935	Cytochrome c Oxidase 6B1 Antibody	50ug/50ul ,100ug/100ul	Human	WB	200ug	59670
CLSDF8936	Cytochrome c Oxidase 7A2 Antibody	50ug/50ul ,100ug/100ul	Human	WB	200ug	59670
CLSDF8937	Cytochrome c Oxidase 7B2 Antibody	50ug/50ul ,100ug/100ul	Human	WB	200ug	59670
CLSDF8938	Cytochrome b561 Antibody	50ug/50ul ,100ug/100ul	Human, Mouse	WB	200ug	59670
CLSDF8939	DRD1IP Antibody	50ug/50ul ,100ug/100ul	Human	WB IHC	200ug	59670

Antibodies
HSN : 38220090

Cat#	Product Description	MW	Reactivity	Application	Pack Size	Unit Price
CLSDF8940	DNAJA1 Antibody	50ug/50ul ,100ug/100ul	Human, Mouse, Rat	WB IHC	200ug	59670
CLSDF8941	DNAJB5 Antibody	50ug/50ul ,100ug/100ul	Human, Mouse	WB IHC	200ug	59670
CLSDF8942	HJURP Antibody	50ug/50ul ,100ug/100ul	Human	WB	200ug	59670
CLSDF8943	FAT1 Antibody	50ug/50ul ,100ug/100ul	Human, Rat	WB	200ug	59670
CLSDF8944	FGF11 Antibody	50ug/50ul ,100ug/100ul	Human, Mouse, Rat	WB IHC	200ug	59670
CLSDF8945	FGF16 Antibody	50ug/50ul ,100ug/100ul	Human, Mouse, Rat	WB IHC	200ug	59670
CLSDF8946	FGF20 Antibody	50ug/50ul ,100ug/100ul	Human, Mouse, Rat	WB	200ug	59670
CLSDF8947	FGF21 Antibody	50ug/50ul ,100ug/100ul	Human	WB	200ug	59670
CLSDF8948	FGF4 Antibody	50ug/50ul ,100ug/100ul	Human, Mouse, Rat	WB	200ug	59670
CLSDF8949	FGF6 Antibody	50ug/50ul ,100ug/100ul	Human, Mouse, Rat	WB	200ug	59670
CLSDF8950	FGFBP3 Antibody	50ug/50ul ,100ug/100ul	Human	WB	200ug	59670
CLSDF8951	FKSG2 Antibody	50ug/50ul ,100ug/100ul	Human	WB IHC	200ug	59670
CLSDF8952	GPD1 Antibody	50ug/50ul ,100ug/100ul	Human, Mouse, Rat	WB	200ug	59670
CLSDF8953	GTSE1 Antibody	50ug/50ul ,100ug/100ul	Human	WB	200ug	59670
CLSDF8954	HSPB1 Antibody	50ug/50ul ,100ug/100ul	Human, Mouse, Rat	WB	200ug	59670
CLSDF8955	HSP74 Antibody	50ug/50ul ,100ug/100ul	Human, Mouse, Rat	WB	200ug	59670
CLSDF8956	HSP76 Antibody	50ug/50ul ,100ug/100ul	Human	WB	200ug	59670
CLSDF8957	IL10RB Antibody	50ug/50ul ,100ug/100ul	Human	WB	200ug	59670
CLSDF8958	IBP4 Antibody	50ug/50ul ,100ug/100ul	Human	WB	200ug	59670
CLSDF8959	IBP6 Antibody	50ug/50ul ,100ug/100ul	Human	WB	200ug	59670
CLSDF8960	ICBR Antibody	50ug/50ul ,100ug/100ul	Human	WB IHC	200ug	59670
CLSDF8961	IFI44 Antibody	50ug/50ul ,100ug/100ul	Human	WB IHC	200ug	59670
CLSDF8962	IFIT2 Antibody	50ug/50ul ,100ug/100ul	Human	WB IHC	200ug	59670
CLSDF8963	IFIT3 Antibody	50ug/50ul ,100ug/100ul	Human	WB	200ug	59670
CLSDF8964	IFM2 Antibody	50ug/50ul ,100ug/100ul	Human	WB	200ug	59670
CLSDF8965	IFN10 Antibody	50ug/50ul ,100ug/100ul	Human	WB	200ug	59670
CLSDF8966	IFN14 Antibody	50ug/50ul ,100ug/100ul	Human	WB	200ug	59670
CLSDF8967	IFN16 Antibody	50ug/50ul ,100ug/100ul	Human	WB	200ug	59670
CLSDF8968	IFN17 Antibody	50ug/50ul ,100ug/100ul	Human	WB	200ug	59670
CLSDF8969	IFN21 Antibody	50ug/50ul ,100ug/100ul	Human	WB	200ug	59670
CLSDF8970	IFNA5 Antibody	50ug/50ul ,100ug/100ul	Human	WB IHC	200ug	59670
CLSDF8971	IFNA6 Antibody	50ug/50ul ,100ug/100ul	Human	WB	200ug	59670
CLSDF8972	IFNA7 Antibody	50ug/50ul ,100ug/100ul	Human	WB	200ug	59670
CLSDF8973	IFNA8 Antibody	50ug/50ul ,100ug/100ul	Human	WB	200ug	59670
CLSDF8974	IFNK Antibody	50ug/50ul ,100ug/100ul	Human	WB	200ug	59670
CLSDF8975	IFRD2 Antibody	50ug/50ul ,100ug/100ul	Human, Mouse	WB	200ug	59670
CLSDF8976	IFIT1B Antibody	50ug/50ul ,100ug/100ul	Human	WB	200ug	59670
CLSDF8977	IGFL3 Antibody	50ug/50ul ,100ug/100ul	Human	WB	200ug	59670
CLSDF8978	IRGC Antibody	50ug/50ul ,100ug/100ul	Human	WB	200ug	59670

Antibodies
HSN : 38220090

Cat#	Product Description	MW	Reactivity	Application	Pack Size	Unit Price
CLSDF8979	IL17B Antibody	50ug/50ul ,100ug/100ul	Human, Mouse	WB IHC	200ug	59670
CLSDF8980	IL17C Antibody	50ug/50ul ,100ug/100ul	Human, Mouse	WB IHC	200ug	59670
CLSDF8981	IL17F Antibody	50ug/50ul ,100ug/100ul	Human	WB IHC	200ug	59670
CLSDF8982	IL19 Antibody	50ug/50ul ,100ug/100ul	Human	WB	200ug	59670
CLSDF8983	IL26 Antibody	50ug/50ul ,100ug/100ul	Human	WB	200ug	59670
CLSDF8984	IL28B Antibody	50ug/50ul ,100ug/100ul	Human, Mouse	WB IHC	200ug	59670
CLSDF8985	IL3 Antibody	50ug/50ul ,100ug/100ul	Human	WB IHC	200ug	59670
CLSDF8986	IL31 Antibody	50ug/50ul ,100ug/100ul	Human	WB	200ug	59670
CLSDF8987	ILRL2 Antibody	50ug/50ul ,100ug/100ul	Human	WB	200ug	59670
CLSDF8988	INGR2 Antibody	50ug/50ul ,100ug/100ul	Human	WB	200ug	59670
CLSDF8989	IFI27 Antibody	50ug/50ul ,100ug/100ul	Human	WB	200ug	59670
CLSDF8990	INSIG2 Antibody	50ug/50ul ,100ug/100ul	Human, Mouse, Rat	WB	200ug	59670
CLSDF8991	INSL5 Antibody	50ug/50ul ,100ug/100ul	Human, Mouse	WB IHC	200ug	59670
CLSDF8992	ITGA11 Antibody	50ug/50ul ,100ug/100ul	Human, Mouse	WB	200ug	59670
CLSDF8993	ITGA8 Antibody	50ug/50ul ,100ug/100ul	Human, Mouse	WB	200ug	59670
CLSDF8994	ITGA9 Antibody	50ug/50ul ,100ug/100ul	Human, Mouse	WB	200ug	59670
CLSDF8995	ITGAD Antibody	50ug/50ul ,100ug/100ul	Human, Mouse, Rat	WB	200ug	59670
CLSDF8996	ITBP2 Antibody	50ug/50ul ,100ug/100ul	Human, Mouse	WB	200ug	59670
CLSDF8997	ITFG2 Antibody	50ug/50ul ,100ug/100ul	Human, Mouse	WB	200ug	59670
CLSDF8998	KDM5A Antibody	50ug/50ul ,100ug/100ul	Human, Mouse	WB	200ug	59670
CLSDF8999	JAM3 Antibody	50ug/50ul ,100ug/100ul	Human, Mouse, Rat	WB	200ug	59670
CLSDF9000	Keratin 23 Antibody	50ug/50ul ,100ug/100ul	Human	WB IHC	200ug	59670
CLSDF9001	Keratin 9 Antibody	50ug/50ul ,100ug/100ul	Human, Mouse, Rat	WB IHC	200ug	59670
CLSDF9002	K1H1 Antibody	50ug/50ul ,100ug/100ul	Human, Mouse	WB IHC	200ug	59670
CLSDF9003	K1H2 Antibody	50ug/50ul ,100ug/100ul	Human	WB	200ug	59670
CLSDF9004	K1H4 Antibody	50ug/50ul ,100ug/100ul	Human	WB	200ug	59670
CLSDF9005	K1H5 Antibody	50ug/50ul ,100ug/100ul	Human, Mouse	WB	200ug	59670
CLSDF9006	K1H7 Antibody	50ug/50ul ,100ug/100ul	Human	WB	200ug	59670
CLSDF9007	K1HB Antibody	50ug/50ul ,100ug/100ul	Human	WB	200ug	59670
CLSDF9008	K22E Antibody	50ug/50ul ,100ug/100ul	Human	WB	200ug	59670
CLSDF9009	K22O Antibody	50ug/50ul ,100ug/100ul	Human	WB	200ug	59670
CLSDF9010	K2C3 Antibody	50ug/50ul ,100ug/100ul	Human	WB IHC	200ug	59670
CLSDF9011	K2C6B Antibody	50ug/50ul ,100ug/100ul	Human	WB	200ug	59670
CLSDF9012	KRT81 Antibody	50ug/50ul ,100ug/100ul	Human	WB	200ug	59670
CLSDF9013	KRT83 Antibody	50ug/50ul ,100ug/100ul	Human	WB	200ug	59670
CLSDF9014	MAGA4 Antibody	50ug/50ul ,100ug/100ul	Human	WB	200ug	59670
CLSDF9015	MAGAA Antibody	50ug/50ul ,100ug/100ul	Human	WB	200ug	59670
CLSDF9016	MAGB1 Antibody	50ug/50ul ,100ug/100ul	Human	WB	200ug	59670
CLSDF9017	MAGB4 Antibody	50ug/50ul ,100ug/100ul	Human	WB	200ug	59670

Antibodies
HSN : 38220090

Cat#	Product Description	MW	Reactivity	Application	Pack Size	Unit Price
CLSDF9018	MAGC3 Antibody	50ug/50ul ,100ug/100ul	Human, Mouse, Rat	WB	200ug	59670
CLSDF9019	MAGE1 Antibody	50ug/50ul ,100ug/100ul	Human, Mouse, Rat	WB IHC	200ug	59670
CLSDF9020	MAGF1 Antibody	50ug/50ul ,100ug/100ul	Human	WB IHC	200ug	59670
CLSDF9021	ROBLD3 Antibody	50ug/50ul ,100ug/100ul	Human, Mouse	WB IHC	200ug	59670
CLSDF9022	MYL6B Antibody	50ug/50ul ,100ug/100ul	Human	WB	200ug	59670
CLSDF9023	MYLK2 Antibody	50ug/50ul ,100ug/100ul	Human, Mouse, Rat	WB	200ug	59670
CLSDF9024	MYST3 Antibody	50ug/50ul ,100ug/100ul	Human, Mouse, Rat	WB IHC	200ug	59670
CLSDF9025	CYB5R4 Antibody	50ug/50ul ,100ug/100ul	Human	WB IHC	200ug	59670
CLSDF9026	NFAM1 Antibody	50ug/50ul ,100ug/100ul	Human	WB	200ug	59670
CLSDF9027	PDCD6IP Antibody	50ug/50ul ,100ug/100ul	Human, Mouse, Rat	WB	200ug	59670
CLSDF9028	PDCD2 Antibody	50ug/50ul ,100ug/100ul	Human, Mouse, Rat	WB	200ug	59670
CLSDF9029	PDCD7 Antibody	50ug/50ul ,100ug/100ul	Human, Mouse	WB	200ug	59670
CLSDF9030	PDCD2L Antibody	50ug/50ul ,100ug/100ul	Human	WB	200ug	59670
CLSDF9031	PLCD1 Antibody	50ug/50ul ,100ug/100ul	Human, Mouse, Rat	WB	200ug	59670
CLSDF9032	PLCH2 Antibody	50ug/50ul ,100ug/100ul	Human, Mouse	WB IHC	200ug	59670
CLSDF9033	ALPPL2 Antibody	50ug/50ul ,100ug/100ul	Human	WB	200ug	59670
CLSDF9034	TUBE1 Antibody	50ug/50ul ,100ug/100ul	Human, Mouse	WB	200ug	59670
CLSDF9035	TIAF1 Antibody	50ug/50ul ,100ug/100ul	Human, Mouse	WB	200ug	59670
CLSDF9036	VEZF1 Antibody	50ug/50ul ,100ug/100ul	Human, Mouse	WB	200ug	59670
CLSDF9037	VNN2 Antibody	50ug/50ul ,100ug/100ul	Human	WB	200ug	59670
CLSDF9038	WN10B Antibody	50ug/50ul ,100ug/100ul	Human, Mouse	WB	200ug	59670
CLSDF9039	WNT11 Antibody	50ug/50ul ,100ug/100ul	Human, Mouse, Rat	WB	200ug	59670
CLSDF9040	WNT4 Antibody	50ug/50ul ,100ug/100ul	Human, Mouse, Rat	WB	200ug	59670
CLSDF9041	WNT6 Antibody	50ug/50ul ,100ug/100ul	Human, Mouse	WB IHC	200ug	59670
CLSDF9042	WNT7B Antibody	50ug/50ul ,100ug/100ul	Human, Mouse, Rat	WB IHC	200ug	59670
CLSDF9043	WNT8A Antibody	50ug/50ul ,100ug/100ul	Human, Mouse	WB IHC	200ug	59670
CLSDF9044	WNT9A Antibody	50ug/50ul ,100ug/100ul	Human, Mouse	WB	200ug	59670
CLSDF9045	WNT9B Antibody	50ug/50ul ,100ug/100ul	Human, Mouse	WB	200ug	59670
CLSDF9046	XCR1 Antibody	50ug/50ul ,100ug/100ul	Human	WB IHC	200ug	59670
CLSDF9047	CCNB2 Antibody	50ug/50ul ,100ug/100ul	Human, Mouse, Rat	WB IHC	200ug	59670
CLSDF9048	MYLPF Antibody	50ug/50ul ,100ug/100ul	Human, Mouse, Rat	WB	200ug	59670
CLSDF9049	SYT2 Antibody	50ug/50ul ,100ug/100ul	Human, Mouse, Rat	WB	200ug	59670
CLSDF9050	TNIK Antibody	50ug/50ul ,100ug/100ul	Human, Mouse	WB	200ug	59670
CLSDF9051	ACINU Antibody	50ug/50ul ,100ug/100ul	Human, Mouse, Rat	WB	200ug	59670
CLSDF9052	LAMC2 Antibody	50ug/50ul ,100ug/100ul	Human	WB	200ug	59670
CLSDF9053	CIDEA Antibody	50ug/50ul ,100ug/100ul	Human	WB IHC	200ug	59670
CLSDF9054	GZMA Antibody	50ug/50ul ,100ug/100ul	Human	WB	200ug	59670
CLSDF9055	RAD54B Antibody	50ug/50ul ,100ug/100ul	Human	WB	200ug	59670
CLSDF9056	EDA-A1 Receptor Antibody	50ug/50ul ,100ug/100ul	Human, Mouse	WB	200ug	59670

Antibodies
HSN : 38220090

Cat#	Product Description	MW	Reactivity	Application	Pack Size	Unit Price
CLSDF9057	CENPC1 Antibody	50ug/50ul ,100ug/100ul	Human	WB	200ug	59670
CLSDF9058	CENPH Antibody	50ug/50ul ,100ug/100ul	Human	WB	200ug	59670
CLSDF9059	CENPK Antibody	50ug/50ul ,100ug/100ul	Human, Mouse	WB	200ug	59670
CLSDF9060	CENPP Antibody	50ug/50ul ,100ug/100ul	Human	WB	200ug	59670
CLSDF9061	CENPQ Antibody	50ug/50ul ,100ug/100ul	Human	WB	200ug	59670
CLSDF9062	ACAA2 Antibody	50ug/50ul ,100ug/100ul	Human	WB IHC	200ug	59670
CLSDF9063	HUS1B Antibody	50ug/50ul ,100ug/100ul	Human	WB IHC	200ug	59670
CLSDF9064	RFC5 Antibody	50ug/50ul ,100ug/100ul	Human, Mouse	WB IHC	200ug	59670
CLSDF9065	STRN4 Antibody	50ug/50ul ,100ug/100ul	Human, Mouse	WB	200ug	59670
CLSDF9066	NFKBIL1 Antibody	50ug/50ul ,100ug/100ul	Human, Mouse, Rat	WB	200ug	59670
CLSDF9067	NKIRAS1 Antibody	50ug/50ul ,100ug/100ul	Human, Mouse	WB IHC	200ug	59670
CLSDF9068	MYCNOS Antibody	50ug/50ul ,100ug/100ul	Human	WB IHC	200ug	59670
CLSDF9069	NKAP Antibody	50ug/50ul ,100ug/100ul	Human	WB	200ug	59670
CLSDF9070	CREB3L4 Antibody	50ug/50ul ,100ug/100ul	Human, Mouse, Rat	WB	200ug	59670
CLSDF9071	GOLT1B Antibody	50ug/50ul ,100ug/100ul	Human, Mouse	WB	200ug	59670
CLSDF9072	ACTL6B Antibody	50ug/50ul ,100ug/100ul	Human, Mouse	WB	200ug	59670
CLSDF9073	ALKBH2 Antibody	50ug/50ul ,100ug/100ul	Human, Mouse	WB	200ug	59670
CLSDF9074	ALKBH7 Antibody	50ug/50ul ,100ug/100ul	Human, Mouse	WB IHC	200ug	59670
CLSDF9075	BCL6B Antibody	50ug/50ul ,100ug/100ul	Human, Mouse	WB	200ug	59670
CLSDF9076	ERCC2 Antibody	50ug/50ul ,100ug/100ul	Human, Mouse	WB	200ug	59670
CLSDF9077	GEMIN8 Antibody	50ug/50ul ,100ug/100ul	Human, Mouse, Rat	WB	200ug	59670
CLSDF9078	KLF16 Antibody	50ug/50ul ,100ug/100ul	Human, Mouse	WB	200ug	59670
CLSDF9079	MAF1 Antibody	50ug/50ul ,100ug/100ul	Human, Mouse, Rat	WB	200ug	59670
CLSDF9080	PER1 Antibody	50ug/50ul ,100ug/100ul	Human, Mouse, Rat	WB	200ug	59670
CLSDF9081	SP5 Antibody	50ug/50ul ,100ug/100ul	Human, Mouse	WB	200ug	59670
CLSDF9082	SP6 Antibody	50ug/50ul ,100ug/100ul	Human, Mouse	WB	200ug	59670
CLSDF9083	TNIP3 Antibody	50ug/50ul ,100ug/100ul	Human	WB IHC	200ug	59670
CLSDF9084	FMR1NB Antibody	50ug/50ul ,100ug/100ul	Human	WB IHC	200ug	59670
CLSDF9085	ORC2L Antibody	50ug/50ul ,100ug/100ul	Human	WB IHC	200ug	59670
CLSDF9086	ORC4L Antibody	50ug/50ul ,100ug/100ul	Human, Mouse, Rat	WB	200ug	59670
CLSDF9087	ORC6L Antibody	50ug/50ul ,100ug/100ul	Human, Mouse	WB	200ug	59670
CLSDF9088	POU3F3 Antibody	50ug/50ul ,100ug/100ul	Human, Mouse, Rat	WB IHC	200ug	59670
CLSDF9089	POU5F2 Antibody	50ug/50ul ,100ug/100ul	Human	WB IHC	200ug	59670
CLSDF9090	SOX17 Antibody	50ug/50ul ,100ug/100ul	Human, Mouse	WB	200ug	59670
CLSDF9091	AGPAT1 Antibody	50ug/50ul ,100ug/100ul	Human, Mouse, Rat	WB	200ug	59670
CLSDF9092	AGPAT7 Antibody	50ug/50ul ,100ug/100ul	Human	WB	200ug	59670
CLSDF9093	PSMD13 Antibody	50ug/50ul ,100ug/100ul	Human, Mouse, Rat	WB	200ug	59670
CLSDF9094	PSMD9 Antibody	50ug/50ul ,100ug/100ul	Human, Mouse, Rat	WB	200ug	59670
CLSDF9095	MRPS15 Antibody	50ug/50ul ,100ug/100ul	Human, Mouse	WB	200ug	59670

Antibodies
HSN : 38220090

Cat#	Product Description	MW	Reactivity	Application	Pack Size	Unit Price
CLSDF9096	MRPS18B Antibody	50ug/50ul ,100ug/100ul	Human, Mouse, Rat	WB IHC	200ug	59670
CLSDF9097	MRPS26 Antibody	50ug/50ul ,100ug/100ul	Human	WB	200ug	59670
CLSDF9098	MRPS31 Antibody	50ug/50ul ,100ug/100ul	Human	WB	200ug	59670
CLSDF9099	MOGAT3 Antibody	50ug/50ul ,100ug/100ul	Human	WB	200ug	59670
CLSDF9100	HSD3B1 Antibody	50ug/50ul ,100ug/100ul	Human	WB	200ug	59670
CLSDF9101	MRPL1 Antibody	50ug/50ul ,100ug/100ul	Human	WB	200ug	59670
CLSDF9102	MRPL17 Antibody	50ug/50ul ,100ug/100ul	Human	WB	200ug	59670
CLSDF9103	MRPL19 Antibody	50ug/50ul ,100ug/100ul	Human, Mouse	WB	200ug	59670
CLSDF9104	MRPL2 Antibody	50ug/50ul ,100ug/100ul	Human, Mouse, Rat	WB	200ug	59670
CLSDF9105	MRPL28 Antibody	50ug/50ul ,100ug/100ul	Human, Mouse	WB IHC	200ug	59670
CLSDF9106	MRPL30 Antibody	50ug/50ul ,100ug/100ul	Human, Mouse, Rat	WB IHC	200ug	59670
CLSDF9107	MRPL34 Antibody	50ug/50ul ,100ug/100ul	Human, Mouse	WB IHC	200ug	59670
CLSDF9108	MRPL37 Antibody	50ug/50ul ,100ug/100ul	Human	WB	200ug	59670
CLSDF9109	MRPL38 Antibody	50ug/50ul ,100ug/100ul	Human	WB	200ug	59670
CLSDF9110	MRPL43 Antibody	50ug/50ul ,100ug/100ul	Human	WB	200ug	59670
CLSDF9111	MRPL45 Antibody	50ug/50ul ,100ug/100ul	Human	WB	200ug	59670
CLSDF9112	MRPL52 Antibody	50ug/50ul ,100ug/100ul	Human	WB	200ug	59670
CLSDF9113	MRPL53 Antibody	50ug/50ul ,100ug/100ul	Human, Mouse, Rat	WB IHC	200ug	59670
CLSDF9114	MRPL55 Antibody	50ug/50ul ,100ug/100ul	Human, Mouse	WB	200ug	59670
CLSDF9115	HAAO Antibody	50ug/50ul ,100ug/100ul	Human, Mouse, Rat	WB	200ug	59670
CLSDF9116	RPS10 Antibody	50ug/50ul ,100ug/100ul	Human, Mouse, Rat	WB	200ug	59670
CLSDF9117	RPS15A Antibody	50ug/50ul ,100ug/100ul	Human, Mouse, Rat	WB	200ug	59670
CLSDF9118	RPS17 Antibody	50ug/50ul ,100ug/100ul	Human, Mouse, Rat	WB	200ug	59670
CLSDF9119	RPS21 Antibody	50ug/50ul ,100ug/100ul	Human, Mouse, Rat	WB	200ug	59670
CLSDF9120	RPS24 Antibody	50ug/50ul ,100ug/100ul	Human, Mouse, Rat	WB	200ug	59670
CLSDF9121	RPS26L1 Antibody	50ug/50ul ,100ug/100ul	Human	WB	200ug	59670
CLSDF9122	RPS27 Antibody	50ug/50ul ,100ug/100ul	Human, Mouse, Rat	WB IHC	200ug	59670
CLSDF9123	RPS3A Antibody	50ug/50ul ,100ug/100ul	Human, Mouse, Rat	WB IHC	200ug	59670
CLSDF9124	RPS4Y1/2 Antibody	50ug/50ul ,100ug/100ul	Human	WB IHC	200ug	59670
CLSDF9125	RPLP1 Antibody	50ug/50ul ,100ug/100ul	Human, Mouse, Rat	WB	200ug	59670
CLSDF9126	RPL13A Antibody	50ug/50ul ,100ug/100ul	Human, Mouse, Rat	WB	200ug	59670
CLSDF9127	RPL18A Antibody	50ug/50ul ,100ug/100ul	Human, Mouse, Rat	WB IHC	200ug	59670
CLSDF9128	RPL24 Antibody	50ug/50ul ,100ug/100ul	Human, Mouse, Rat	WB IHC	200ug	59670
CLSDF9129	RPL27 Antibody	50ug/50ul ,100ug/100ul	Human, Mouse, Rat	WB	200ug	59670
CLSDF9130	RPL29 Antibody	50ug/50ul ,100ug/100ul	Human, Mouse, Rat	WB	200ug	59670
CLSDF9131	RPL35A Antibody	50ug/50ul ,100ug/100ul	Human, Mouse, Rat	WB	200ug	59670
CLSDF9132	RPL36L Antibody	50ug/50ul ,100ug/100ul	Human	WB	200ug	59670
CLSDF9133	RPL37 Antibody	50ug/50ul ,100ug/100ul	Human, Mouse, Rat	WB	200ug	59670
CLSDF9134	RPL38 Antibody	50ug/50ul ,100ug/100ul	Human, Mouse, Rat	WB	200ug	59670

Antibodies
HSN : 38220090

Cat#	Product Description	MW	Reactivity	Application	Pack Size	Unit Price
CLSDF9135	RPL4 Antibody	50ug/50ul ,100ug/100ul	Human, Mouse, Rat	WB IHC	200ug	59670
CLSDF9136	RPL41 Antibody	50ug/50ul ,100ug/100ul	Human, Mouse, Rat	WB	200ug	59670
CLSDF9137	RPL7A Antibody	50ug/50ul ,100ug/100ul	Human, Mouse, Rat	WB	200ug	59670
CLSDF9138	NIP7 Antibody	50ug/50ul ,100ug/100ul	Human, Mouse, Rat	WB	200ug	59670
CLSDF9139	INPP5E Antibody	50ug/50ul ,100ug/100ul	Human, Mouse, Rat	WB	200ug	59670
CLSDF9140	ABHD1 Antibody	50ug/50ul ,100ug/100ul	Human, Mouse, Rat	WB	200ug	59670
CLSDF9141	ABHD10 Antibody	50ug/50ul ,100ug/100ul	Human, Rat	WB	200ug	59670
CLSDF9142	ABHD13 Antibody	50ug/50ul ,100ug/100ul	Human, Mouse	WB	200ug	59670
CLSDF9143	ABHD3 Antibody	50ug/50ul ,100ug/100ul	Human, Mouse	WB	200ug	59670
CLSDF9144	CHRNA Antibody	50ug/50ul ,100ug/100ul	Human, Mouse, Rat	WB IHC	200ug	59670
CLSDF9145	ABLIM1 Antibody	50ug/50ul ,100ug/100ul	Human, Mouse	WB IHC	200ug	59670
CLSDF9146	ACVR2B Antibody	50ug/50ul ,100ug/100ul	Human, Mouse, Rat	WB IHC	200ug	59670
CLSDF9147	ACAD11 Antibody	50ug/50ul ,100ug/100ul	Human	WB	200ug	59670
CLSDF9148	ACAD9 Antibody	50ug/50ul ,100ug/100ul	Human, Mouse, Rat	WB	200ug	59670
CLSDF9149	AWAT2 Antibody	50ug/50ul ,100ug/100ul	Human, Mouse	WB IHC	200ug	59670
CLSDF9150	LPGAT1 Antibody	50ug/50ul ,100ug/100ul	Human	WB IHC	200ug	59670
CLSDF9151	ACBD4 Antibody	50ug/50ul ,100ug/100ul	Human	WB	200ug	59670
CLSDF9152	ACBD5 Antibody	50ug/50ul ,100ug/100ul	Human, Mouse, Rat	WB	200ug	59670
CLSDF9153	ACBD7 Antibody	50ug/50ul ,100ug/100ul	Human, Mouse	WB	200ug	59670
CLSDF9154	ACOX2 Antibody	50ug/50ul ,100ug/100ul	Human, Mouse, Rat	WB	200ug	59670
CLSDF9155	ACOX3 Antibody	50ug/50ul ,100ug/100ul	Human	WB	200ug	59670
CLSDF9156	ACOT11 Antibody	50ug/50ul ,100ug/100ul	Human, Mouse	WB	200ug	59670
CLSDF9157	ACOT9 Antibody	50ug/50ul ,100ug/100ul	Human, Mouse	WB IHC	200ug	59670
CLSDF9158	AOAH Antibody	50ug/50ul ,100ug/100ul	Human, Mouse	WB	200ug	59670
CLSDF9159	ACYP2 Antibody	50ug/50ul ,100ug/100ul	Human, Rat	WB	200ug	59670
CLSDF9160	LYPLA2 Antibody	50ug/50ul ,100ug/100ul	Human, Mouse, Rat	WB	200ug	59670
CLSDF9161	ADAM19 Antibody	50ug/50ul ,100ug/100ul	Human, Mouse	WB	200ug	59670
CLSDF9162	ADAM23 Antibody	50ug/50ul ,100ug/100ul	Human, Mouse	WB	200ug	59670
CLSDF9163	ADAM28 Antibody	50ug/50ul ,100ug/100ul	Human, Rat	WB	200ug	59670
CLSDF9164	ADAM29 Antibody	50ug/50ul ,100ug/100ul	Human	WB	200ug	59670
CLSDF9165	ADAM30 Antibody	50ug/50ul ,100ug/100ul	Human	WB	200ug	59670
CLSDF9166	ADAM33 Antibody	50ug/50ul ,100ug/100ul	Human	WB IHC	200ug	59670
CLSDF9167	ADAMDEC1 Antibody	50ug/50ul ,100ug/100ul	Human	WB IHC	200ug	59670
CLSDF9168	ADAMTS1 Antibody	50ug/50ul ,100ug/100ul	Human	WB IHC	200ug	59670
CLSDF9169	ADAMTS10 Antibody	50ug/50ul ,100ug/100ul	Human, Mouse	WB	200ug	59670
CLSDF9170	ADAMTS12 Antibody	50ug/50ul ,100ug/100ul	Human	WB	200ug	59670
CLSDF9171	ADAMTS13 Antibody	50ug/50ul ,100ug/100ul	Human	WB IHC	200ug	59670
CLSDF9172	ADAMTS14 Antibody	50ug/50ul ,100ug/100ul	Human, Mouse	WB IHC	200ug	59670
CLSDF9173	ADAMTS16 Antibody	50ug/50ul ,100ug/100ul	Human, Mouse	WB	200ug	59670

Antibodies
HSN : 38220090

Cat#	Product Description	MW	Reactivity	Application	Pack Size	Unit Price
CLSDF9174	ADAMTS17 Antibody	50ug/50ul ,100ug/100ul	Human, Mouse	WB IHC	200ug	59670
CLSDF9175	ADAMTS2 Antibody	50ug/50ul ,100ug/100ul	Human	WB	200ug	59670
CLSDF9176	ADAMTS20 Antibody	50ug/50ul ,100ug/100ul	Human	WB	200ug	59670
CLSDF9177	ADAMTS7 Antibody	50ug/50ul ,100ug/100ul	Human	WB	200ug	59670
CLSDF9178	ADAMTS9 Antibody	50ug/50ul ,100ug/100ul	Human	WB	200ug	59670
CLSDF9179	SLC25A5 Antibody	50ug/50ul ,100ug/100ul	Human, Mouse, Rat	WB	200ug	59670
CLSDF9180	AFF4 Antibody	50ug/50ul ,100ug/100ul	Human, Mouse	WB IHC	200ug	59670
CLSDF9181	AGRN Antibody	50ug/50ul ,100ug/100ul	Human, Mouse, Rat	WB	200ug	59670
CLSDF9182	AAAS Antibody	50ug/50ul ,100ug/100ul	Human	WB	200ug	59670
CLSDF9183	GPT2 Antibody	50ug/50ul ,100ug/100ul	Human	WB	200ug	59670
CLSDF9184	AGXT2 Antibody	50ug/50ul ,100ug/100ul	Human, Mouse, Rat	WB	200ug	59670
CLSDF9185	AGXT2L1 Antibody	50ug/50ul ,100ug/100ul	Human, Mouse	WB	200ug	59670
CLSDF9186	C9orf23 Antibody	50ug/50ul ,100ug/100ul	Human, Mouse	WB	200ug	59670
CLSDF9187	ALDH1A3 Antibody	50ug/50ul ,100ug/100ul	Human, Mouse, Rat	WB	200ug	59670
CLSDF9188	ALDH3B2 Antibody	50ug/50ul ,100ug/100ul	Human	WB	200ug	59670
CLSDF9189	AKR1C1 Antibody	50ug/50ul ,100ug/100ul	Human	WB IHC	200ug	59670
CLSDF9190	AKR1C4 Antibody	50ug/50ul ,100ug/100ul	Human	WB IHC	200ug	59670
CLSDF9191	GALM Antibody	50ug/50ul ,100ug/100ul	Human, Mouse, Rat	WB IHC	200ug	59670
CLSDF9192	ASAH3 Antibody	50ug/50ul ,100ug/100ul	Human	WB	200ug	59670
CLSDF9193	SERPINA2 Antibody	50ug/50ul ,100ug/100ul	Human	WB	200ug	59670
CLSDF9194	SERPINF2 Antibody	50ug/50ul ,100ug/100ul	Human	WB IHC	200ug	59670
CLSDF9195	CTNNAL1 Antibody	50ug/50ul ,100ug/100ul	Human, Mouse	WB IHC	200ug	59670
CLSDF9196	ALS2 Antibody	50ug/50ul ,100ug/100ul	Human, Mouse, Rat	WB	200ug	59670
CLSDF9197	ALMS1 Antibody	50ug/50ul ,100ug/100ul	Human	WB IHC	200ug	59670
CLSDF9198	ACCN2 Antibody	50ug/50ul ,100ug/100ul	Human, Mouse, Rat	WB	200ug	59670
CLSDF9199	SCNN1A Antibody	50ug/50ul ,100ug/100ul	Human, Mouse, Rat	WB	200ug	59670
CLSDF9200	AMPD3 Antibody	50ug/50ul ,100ug/100ul	Human, Mouse, Rat	WB	200ug	59670
CLSDF9201	AAT1 Antibody	50ug/50ul ,100ug/100ul	Human	WB	200ug	59670
CLSDF9202	APBA1 Antibody	50ug/50ul ,100ug/100ul	Human, Mouse, Rat	WB	200ug	59670
CLSDF9203	APBA2 Antibody	50ug/50ul ,100ug/100ul	Human, Mouse, Rat	WB IHC	200ug	59670
CLSDF9204	ALS2CR12 Antibody	50ug/50ul ,100ug/100ul	Human	WB	200ug	59670
CLSDF9205	ALS2CR16 Antibody	50ug/50ul ,100ug/100ul	Human	WB	200ug	59670
CLSDF9206	PDS5B Antibody	50ug/50ul ,100ug/100ul	Human, Mouse, Rat	WB	200ug	59670
CLSDF9207	AAMP Antibody	50ug/50ul ,100ug/100ul	Human, Mouse	WB	200ug	59670
CLSDF9208	AMOT Antibody	50ug/50ul ,100ug/100ul	Human, Mouse	WB	200ug	59670
CLSDF9209	ANGPT4 Antibody	50ug/50ul ,100ug/100ul	Human	WB	200ug	59670
CLSDF9210	ANGPTL1 Antibody	50ug/50ul ,100ug/100ul	Human, Mouse	WB	200ug	59670
CLSDF9211	ANGPTL5 Antibody	50ug/50ul ,100ug/100ul	Human	WB	200ug	59670
CLSDF9212	SLC4A2 Antibody	50ug/50ul ,100ug/100ul	Human, Mouse	WB IHC	200ug	59670

Antibodies
HSN : 38220090

Cat#	Product Description	MW	Reactivity	Application	Pack Size	Unit Price
CLSDF9213	SLC4A3 Antibody	50ug/50ul ,100ug/100ul	Human, Mouse, Rat	WB IHC	200ug	59670
CLSDF9214	SLC4A9 Antibody	50ug/50ul ,100ug/100ul	Human	WB IHC	200ug	59670
CLSDF9215	ANXA11 Antibody	50ug/50ul ,100ug/100ul	Human, Mouse, Rat	WB	200ug	59670
CLSDF9216	APOC4 Antibody	50ug/50ul ,100ug/100ul	Human	WB	200ug	59670
CLSDF9217	APOL3 Antibody	50ug/50ul ,100ug/100ul	Human	WB IHC	200ug	59670
CLSDF9218	APOL5 Antibody	50ug/50ul ,100ug/100ul	Human	WB IHC	200ug	59670
CLSDF9219	APOL6 Antibody	50ug/50ul ,100ug/100ul	Human	WB	200ug	59670
CLSDF9220	BCL2L14 Antibody	50ug/50ul ,100ug/100ul	Human, Mouse	WB IHC	200ug	59670
CLSDF9221	AQP10 Antibody	50ug/50ul ,100ug/100ul	Human	WB	200ug	59670
CLSDF9222	AQP11 Antibody	50ug/50ul ,100ug/100ul	Human, Mouse, Rat	WB	200ug	59670
CLSDF9223	AQP6 Antibody	50ug/50ul ,100ug/100ul	Human	WB	200ug	59670
CLSDF9224	AQP8 Antibody	50ug/50ul ,100ug/100ul	Human, Mouse, Rat	WB IHC	200ug	59670
CLSDF9225	AQP9 Antibody	50ug/50ul ,100ug/100ul	Human, Mouse, Rat	WB	200ug	59670
CLSDF9226	ATE1 Antibody	50ug/50ul ,100ug/100ul	Human	WB	200ug	59670
CLSDF9227	ARSB Antibody	50ug/50ul ,100ug/100ul	Human, Mouse, Rat	WB	200ug	59670
CLSDF9228	ARSH Antibody	50ug/50ul ,100ug/100ul	Human	WB	200ug	59670
CLSDF9229	ARSJ Antibody	50ug/50ul ,100ug/100ul	Human, Mouse, Rat	WB	200ug	59670
CLSDF9230	SLC7A10 Antibody	50ug/50ul ,100ug/100ul	Human, Mouse, Rat	WB	200ug	59670
CLSDF9231	ATXN10 Antibody	50ug/50ul ,100ug/100ul	Human, Mouse, Rat	WB	200ug	59670
CLSDF9232	FOX1 Antibody	50ug/50ul ,100ug/100ul	Human	WB	200ug	59670
CLSDF9233	ATXN7 Antibody	50ug/50ul ,100ug/100ul	Human, Mouse	WB IHC	200ug	59670
CLSDF9234	ATXN7L1 Antibody	50ug/50ul ,100ug/100ul	Human, Mouse	WB IHC	200ug	59670
CLSDF9235	ATXN7L3 Antibody	50ug/50ul ,100ug/100ul	Human, Mouse	WB IHC	200ug	59670
CLSDF9236	ATXN7L1 isoform 2 Antibody	50ug/50ul ,100ug/100ul	Human	WB	200ug	59670
CLSDF9237	MT-ATP6 Antibody	50ug/50ul ,100ug/100ul	Human	WB	200ug	59670
CLSDF9238	ATP5E Antibody	50ug/50ul ,100ug/100ul	Human, Mouse, Rat	WB IHC	200ug	59670
CLSDF9239	ATP5G1 Antibody	50ug/50ul ,100ug/100ul	Human, Mouse, Rat	WB IHC	200ug	59670
CLSDF9240	MT-ATP8 Antibody	50ug/50ul ,100ug/100ul	Human	WB	200ug	59670
CLSDF9241	ATP5L Antibody	50ug/50ul ,100ug/100ul	Human, Mouse	WB	200ug	59670
CLSDF9242	ATP5O Antibody	50ug/50ul ,100ug/100ul	Human, Mouse, Rat	WB	200ug	59670
CLSDF9243	ABCA10 Antibody	50ug/50ul ,100ug/100ul	Human	WB	200ug	59670
CLSDF9244	ABCA12 Antibody	50ug/50ul ,100ug/100ul	Human	WB	200ug	59670
CLSDF9245	ABCA3 Antibody	50ug/50ul ,100ug/100ul	Human, Mouse	WB IHC	200ug	59670
CLSDF9246	ABCA5 Antibody	50ug/50ul ,100ug/100ul	Human, Mouse, Rat	WB	200ug	59670
CLSDF9247	ABCA7 Antibody	50ug/50ul ,100ug/100ul	Human	WB	200ug	59670
CLSDF9248	ABCA9 Antibody	50ug/50ul ,100ug/100ul	Human	WB	200ug	59670
CLSDF9249	ABCB8 Antibody	50ug/50ul ,100ug/100ul	Human, Mouse, Rat	WB	200ug	59670
CLSDF9250	ABCD2 Antibody	50ug/50ul ,100ug/100ul	Human	WB	200ug	59670
CLSDF9251	ABCF3 Antibody	50ug/50ul ,100ug/100ul	Human, Mouse, Rat	WB	200ug	59670

Antibodies
HSN : 38220090

Cat#	Product Description	MW	Reactivity	Application	Pack Size	Unit Price
CLSDF9252	ABCG4 Antibody	50ug/50ul ,100ug/100ul	Human	WB	200ug	59670
CLSDF9253	ABCC11 Antibody	50ug/50ul ,100ug/100ul	Human	WB	200ug	59670
CLSDF9254	ABCC8 Antibody	50ug/50ul ,100ug/100ul	Human, Mouse, Rat	WB IHC	200ug	59670
CLSDF9255	ABCC9 Antibody	50ug/50ul ,100ug/100ul	Human	WB IHC	200ug	59670
CLSDF9256	PIF1 Antibody	50ug/50ul ,100ug/100ul	Human, Mouse, Rat	WB IHC	200ug	59670
CLSDF9257	RECQL4 Antibody	50ug/50ul ,100ug/100ul	Human	WB	200ug	59670
CLSDF9258	DDX18 Antibody	50ug/50ul ,100ug/100ul	Human	WB	200ug	59670
CLSDF9259	DDX42 Antibody	50ug/50ul ,100ug/100ul	Human, Mouse	WB IHC	200ug	59670
CLSDF9260	KCNJ10 Antibody	50ug/50ul ,100ug/100ul	Human, Mouse, Rat	WB IHC	200ug	59670
CLSDF9261	KCNJ14 Antibody	50ug/50ul ,100ug/100ul	Human	WB	200ug	59670
CLSDF9262	KCNJ15 Antibody	50ug/50ul ,100ug/100ul	Human	WB	200ug	59670
CLSDF9263	KCNJ8 Antibody	50ug/50ul ,100ug/100ul	Human	WB	200ug	59670
CLSDF9264	AXIN1 Antibody	50ug/50ul ,100ug/100ul	Human, Mouse, Rat	WB	200ug	59670
CLSDF9265	BAGE5 Antibody	50ug/50ul ,100ug/100ul	Human, Mouse, Rat	WB	200ug	59670
CLSDF9266	BATF2 Antibody	50ug/50ul ,100ug/100ul	Human	WB	200ug	59670
CLSDF9267	BNIP1 Antibody	50ug/50ul ,100ug/100ul	Human	WB IHC	200ug	59670
CLSDF9268	GCNT4 Antibody	50ug/50ul ,100ug/100ul	Human	WB	200ug	59670
CLSDF9269	B3GALT2 Antibody	50ug/50ul ,100ug/100ul	Human, Mouse	WB	200ug	59670
CLSDF9270	B3GALT5 Antibody	50ug/50ul ,100ug/100ul	Human	WB	200ug	59670
CLSDF9271	B3GALT6 Antibody	50ug/50ul ,100ug/100ul	Human	WB	200ug	59670
CLSDF9272	B4GALNT2 Antibody	50ug/50ul ,100ug/100ul	Human	WB	200ug	59670
CLSDF9273	B4GALT2 Antibody	50ug/50ul ,100ug/100ul	Human, Mouse	WB	200ug	59670
CLSDF9274	B4GALT4 Antibody	50ug/50ul ,100ug/100ul	Human, Mouse, Rat	WB	200ug	59670
CLSDF9275	B4GALT6 Antibody	50ug/50ul ,100ug/100ul	Human, Mouse, Rat	WB	200ug	59670
CLSDF9276	B4GALT7 Antibody	50ug/50ul ,100ug/100ul	Human, Mouse, Rat	WB IHC	200ug	59670
CLSDF9277	BAAT Antibody	50ug/50ul ,100ug/100ul	Human	WB IHC	200ug	59670
CLSDF9278	ABC11 Antibody	50ug/50ul ,100ug/100ul	Human	WB IHC	200ug	59670
CLSDF9279	CEL Antibody	50ug/50ul ,100ug/100ul	Human	WB	200ug	59670
CLSDF9280	BMP1 Antibody	50ug/50ul ,100ug/100ul	Human, Mouse	WB	200ug	59670
CLSDF9281	BMP15 Antibody	50ug/50ul ,100ug/100ul	Human	WB	200ug	59670
CLSDF9282	BMP3B Antibody	50ug/50ul ,100ug/100ul	Human	WB	200ug	59670
CLSDF9283	SLC25A14 Antibody	50ug/50ul ,100ug/100ul	Human, Mouse, Rat	WB	200ug	59670
CLSDF9284	BRI3 Antibody	50ug/50ul ,100ug/100ul	Human, Mouse, Rat	WB IHC	200ug	59670
CLSDF9285	BSX Antibody	50ug/50ul ,100ug/100ul	Human, Mouse, Rat	WB	200ug	59670
CLSDF9286	PEP-19 Antibody	50ug/50ul ,100ug/100ul	Human, Mouse, Rat	WB	200ug	59670
CLSDF9287	PRSS22 Antibody	50ug/50ul ,100ug/100ul	Human	WB	200ug	59670
CLSDF9288	SLC22A17 Antibody	50ug/50ul ,100ug/100ul	Human, Mouse, Rat	WB	200ug	59670
CLSDF9289	BRAP Antibody	50ug/50ul ,100ug/100ul	Human	WB	200ug	59670
CLSDF9290	BCCIP Antibody	50ug/50ul ,100ug/100ul	Human	WB	200ug	59670

Antibodies
HSN : 38220090

Cat#	Product Description	MW	Reactivity	Application	Pack Size	Unit Price
CLSDF9291	BCAS3 Antibody	50ug/50ul ,100ug/100ul	Human, Mouse	WB	200ug	59670
CLSDF9292	PPP3R1 Antibody	50ug/50ul ,100ug/100ul	Human, Mouse, Rat	WB	200ug	59670
CLSDF9293	PPP3R2 Antibody	50ug/50ul ,100ug/100ul	Human, Rat	WB IHC	200ug	59670
CLSDF9294	CABIN1 Antibody	50ug/50ul ,100ug/100ul	Human, Mouse, Rat	WB IHC	200ug	59670
CLSDF9295	CIB4 Antibody	50ug/50ul ,100ug/100ul	Human	WB IHC	200ug	59670
CLSDF9296	CHERP Antibody	50ug/50ul ,100ug/100ul	Human, Mouse	WB	200ug	59670
CLSDF9297	CAMLG Antibody	50ug/50ul ,100ug/100ul	Human	WB	200ug	59670
CLSDF9298	PDE1A Antibody	50ug/50ul ,100ug/100ul	Human, Mouse, Rat	WB IHC	200ug	59670
CLSDF9299	PDE1B Antibody	50ug/50ul ,100ug/100ul	Human	WB IHC	200ug	59670
CLSDF9300	CAMK2D Antibody	50ug/50ul ,100ug/100ul	Human, Mouse, Rat	WB	200ug	59670
CLSDF9301	KCNMB1 Antibody	50ug/50ul ,100ug/100ul	Human, Mouse, Rat	WB	200ug	59670
CLSDF9302	KCNMB3 Antibody	50ug/50ul ,100ug/100ul	Human	WB	200ug	59670
CLSDF9303	SLC25A13 Antibody	50ug/50ul ,100ug/100ul	Human, Mouse	WB	200ug	59670
CLSDF9304	CABP1 Antibody	50ug/50ul ,100ug/100ul	Human, Mouse, Rat	WB	200ug	59670
CLSDF9305	CABP2 Antibody	50ug/50ul ,100ug/100ul	Human, Mouse	WB	200ug	59670
CLSDF9306	CABP3 Antibody	50ug/50ul ,100ug/100ul	Human	WB IHC	200ug	59670
CLSDF9307	CAB39L Antibody	50ug/50ul ,100ug/100ul	Human, Mouse, Rat	WB	200ug	59670
CLSDF9308	CABP4 Antibody	50ug/50ul ,100ug/100ul	Human, Mouse	WB	200ug	59670
CLSDF9309	CABP5 Antibody	50ug/50ul ,100ug/100ul	Human, Mouse	WB	200ug	59670
CLSDF9310	CABYR Antibody	50ug/50ul ,100ug/100ul	Human	WB	200ug	59670
CLSDF9311	CADPS2 Antibody	50ug/50ul ,100ug/100ul	Human	WB	200ug	59670
CLSDF9312	ATP2C2 Antibody	50ug/50ul ,100ug/100ul	Human	WB	200ug	59670
CLSDF9313	CAMTA1 Antibody	50ug/50ul ,100ug/100ul	Human, Mouse	WB	200ug	59670
CLSDF9314	CAMTA2 Antibody	50ug/50ul ,100ug/100ul	Human, Mouse	WB	200ug	59670
CLSDF9315	CALML3 Antibody	50ug/50ul ,100ug/100ul	Human, Mouse, Rat	WB IHC	200ug	59670
CLSDF9316	CALML5 Antibody	50ug/50ul ,100ug/100ul	Human	WB IHC	200ug	59670
CLSDF9317	CALML6 Antibody	50ug/50ul ,100ug/100ul	Human	WB IHC	200ug	59670
CLSDF9318	CAPNS2 Antibody	50ug/50ul ,100ug/100ul	Human, Mouse	WB	200ug	59670
CLSDF9319	CAPN13 Antibody	50ug/50ul ,100ug/100ul	Human	WB	200ug	59670
CLSDF9320	CAPN3 Antibody	50ug/50ul ,100ug/100ul	Human, Mouse, Rat	WB IHC	200ug	59670
CLSDF9321	CAPN6 Antibody	50ug/50ul ,100ug/100ul	Human, Mouse	WB IHC	200ug	59670
CLSDF9322	CAPN7 Antibody	50ug/50ul ,100ug/100ul	Human, Mouse, Rat	WB	200ug	59670
CLSDF9323	CNN3 Antibody	50ug/50ul ,100ug/100ul	Human, Mouse, Rat	WB	200ug	59670
CLSDF9324	CALR3 Antibody	50ug/50ul ,100ug/100ul	Human, Mouse, Rat	WB	200ug	59670
CLSDF9325	ARPP19 Antibody	50ug/50ul ,100ug/100ul	Human, Mouse, Rat	WB	200ug	59670
CLSDF9326	CTAG2 Antibody	50ug/50ul ,100ug/100ul	Human	WB	200ug	59670
CLSDF9327	CHST11 Antibody	50ug/50ul ,100ug/100ul	Human, Mouse, Rat	WB	200ug	59670
CLSDF9328	CHST12 Antibody	50ug/50ul ,100ug/100ul	Human	WB IHC	200ug	59670
CLSDF9329	CHST3 Antibody	50ug/50ul ,100ug/100ul	Human	WB	200ug	59670

Antibodies
HSN : 38220090

Cat#	Product Description	MW	Reactivity	Application	Pack Size	Unit Price
CLSDF9330	CHST5 Antibody	50ug/50ul ,100ug/100ul	Human	WB	200ug	59670
CLSDF9331	CHST14 Antibody	50ug/50ul ,100ug/100ul	Human, Mouse, Rat	WB	200ug	59670
CLSDF9332	CA7 Antibody	50ug/50ul ,100ug/100ul	Human, Mouse, Rat	WB	200ug	59670
CLSDF9333	CA8 Antibody	50ug/50ul ,100ug/100ul	Human, Mouse, Rat	WB	200ug	59670
CLSDF9334	CA10 Antibody	50ug/50ul ,100ug/100ul	Human, Mouse	WB	200ug	59670
CLSDF9335	CA11 Antibody	50ug/50ul ,100ug/100ul	Human, Mouse, Rat	WB	200ug	59670
CLSDF9336	CPA4 Antibody	50ug/50ul ,100ug/100ul	Human, Mouse	WB	200ug	59670
CLSDF9337	CPA6 Antibody	50ug/50ul ,100ug/100ul	Human, Mouse	WB IHC	200ug	59670
CLSDF9338	CPB1 Antibody	50ug/50ul ,100ug/100ul	Human	WB IHC	200ug	59670
CLSDF9339	CPD Antibody	50ug/50ul ,100ug/100ul	Human, Rat	WB IHC	200ug	59670
CLSDF9340	CPO Antibody	50ug/50ul ,100ug/100ul	Human	WB	200ug	59670
CLSDF9341	CPZ Antibody	50ug/50ul ,100ug/100ul	Human, Rat	WB	200ug	59670
CLSDF9342	CPXM2 Antibody	50ug/50ul ,100ug/100ul	Human	WB IHC	200ug	59670
CLSDF9343	CEACAM16 Antibody	50ug/50ul ,100ug/100ul	Human, Mouse	WB IHC	200ug	59670
CLSDF9344	CEACAM19 Antibody	50ug/50ul ,100ug/100ul	Human, Mouse	WB	200ug	59670
CLSDF9345	CEACAM20 Antibody	50ug/50ul ,100ug/100ul	Human	WB IHC	200ug	59670
CLSDF9346	CEACAM7 Antibody	50ug/50ul ,100ug/100ul	Human	WB	200ug	59670
CLSDF9347	CTNNA2 Antibody	50ug/50ul ,100ug/100ul	Human, Mouse	WB	200ug	59670
CLSDF9348	CTNND2 Antibody	50ug/50ul ,100ug/100ul	Human, Mouse	WB	200ug	59670
CLSDF9349	CATSPER1 Antibody	50ug/50ul ,100ug/100ul	Human	WB	200ug	59670
CLSDF9350	CATSPER3 Antibody	50ug/50ul ,100ug/100ul	Human	WB	200ug	59670
CLSDF9351	CATSPER4 Antibody	50ug/50ul ,100ug/100ul	Human	WB IHC	200ug	59670
CLSDF9352	CATSPERB Antibody	50ug/50ul ,100ug/100ul	Human	WB	200ug	59670
CLSDF9353	CHAC1 Antibody	50ug/50ul ,100ug/100ul	Human	WB	200ug	59670
CLSDF9354	M6PR Antibody	50ug/50ul ,100ug/100ul	Human, Mouse, Rat	WB	200ug	59670
CLSDF9355	SLC7A3 Antibody	50ug/50ul ,100ug/100ul	Human	WB	200ug	59670
CLSDF9356	BORG5 Antibody	50ug/50ul ,100ug/100ul	Human	WB	200ug	59670
CLSDF9357	CGRRF1 Antibody	50ug/50ul ,100ug/100ul	Human	WB	200ug	59670
CLSDF9358	CRABP1 Antibody	50ug/50ul ,100ug/100ul	Human, Mouse, Rat	WB	200ug	59670
CLSDF9359	ACAP2 Antibody	50ug/50ul ,100ug/100ul	Human, Mouse, Rat	WB	200ug	59670
CLSDF9360	CEP110 Antibody	50ug/50ul ,100ug/100ul	Human	WB IHC	200ug	59670
CLSDF9361	CEP27 Antibody	50ug/50ul ,100ug/100ul	Human	WB IHC	200ug	59670
CLSDF9362	CEP41 Antibody	50ug/50ul ,100ug/100ul	Human	WB IHC	200ug	59670
CLSDF9363	CEP63 Antibody	50ug/50ul ,100ug/100ul	Human	WB	200ug	59670
CLSDF9364	CEP68 Antibody	50ug/50ul ,100ug/100ul	Human	WB	200ug	59670
CLSDF9365	CEP72 Antibody	50ug/50ul ,100ug/100ul	Human, Mouse	WB IHC	200ug	59670
CLSDF9366	CSPP1 Antibody	50ug/50ul ,100ug/100ul	Human	WB IHC	200ug	59670
CLSDF9367	CEP250 Antibody	50ug/50ul ,100ug/100ul	Human	WB	200ug	59670
CLSDF9368	CDR1 Antibody	50ug/50ul ,100ug/100ul	Human	WB IHC	200ug	59670

Antibodies
HSN : 38220090

Cat#	Product Description	MW	Reactivity	Application	Pack Size	Unit Price
CLSDF9369	CP Antibody	50ug/50ul ,100ug/100ul	Human	WB	200ug	59670
CLSDF9370	PDE2A Antibody	50ug/50ul ,100ug/100ul	Human, Mouse, Rat	WB	200ug	59670
CLSDF9371	PDE3A Antibody	50ug/50ul ,100ug/100ul	Human	WB	200ug	59670
CLSDF9372	PDE3B Antibody	50ug/50ul ,100ug/100ul	Human	WB	200ug	59670
CLSDF9373	PDE5A Antibody	50ug/50ul ,100ug/100ul	Human, Mouse, Rat	WB	200ug	59670
CLSDF9374	CKLF Antibody	50ug/50ul ,100ug/100ul	Human	WB IHC	200ug	59670
CLSDF9375	CLCN2 Antibody	50ug/50ul ,100ug/100ul	Human, Mouse, Rat	WB	200ug	59670
CLSDF9376	CLCNKB Antibody	50ug/50ul ,100ug/100ul	Human	WB	200ug	59670
CLSDF9377	CLCN1 Antibody	50ug/50ul ,100ug/100ul	Human	WB	200ug	59670
CLSDF9378	CHSY3 Antibody	50ug/50ul ,100ug/100ul	Human, Mouse	WB	200ug	59670
CLSDF9379	SLC18A1 Antibody	50ug/50ul ,100ug/100ul	Human, Mouse, Rat	WB	200ug	59670
CLSDF9380	CBX2 Antibody	50ug/50ul ,100ug/100ul	Human, Mouse	WB	200ug	59670
CLSDF9381	CHD2 Antibody	50ug/50ul ,100ug/100ul	Human	WB	200ug	59670
CLSDF9382	CHD6 Antibody	50ug/50ul ,100ug/100ul	Human, Mouse	WB	200ug	59670
CLSDF9383	CHD8 Antibody	50ug/50ul ,100ug/100ul	Human	WB IHC	200ug	59670
CLSDF9384	CHD9 Antibody	50ug/50ul ,100ug/100ul	Human, Mouse	WB IHC	200ug	59670
CLSDF9385	KIF4B Antibody	50ug/50ul ,100ug/100ul	Human	WB IHC	200ug	59670
CLSDF9386	LUC7L3 Antibody	50ug/50ul ,100ug/100ul	Human, Mouse	WB	200ug	59670
CLSDF9387	CMTM5 Antibody	50ug/50ul ,100ug/100ul	Human	WB	200ug	59670
CLSDF9388	CKLF7 Antibody	50ug/50ul ,100ug/100ul	Human, Mouse	WB IHC	200ug	59670
CLSDF9389	CKLF8 Antibody	50ug/50ul ,100ug/100ul	Human	WB IHC	200ug	59670
CLSDF9390	CLDN12 Antibody	50ug/50ul ,100ug/100ul	Human, Mouse	WB	200ug	59670
CLSDF9391	CLDN14 Antibody	50ug/50ul ,100ug/100ul	Human, Mouse	WB IHC	200ug	59670
CLSDF9392	CLDN18 Antibody	50ug/50ul ,100ug/100ul	Human, Mouse, Rat	WB	200ug	59670
CLSDF9393	CLDN20 Antibody	50ug/50ul ,100ug/100ul	Human	WB	200ug	59670
CLSDF9394	CLDN22/24 Antibody	50ug/50ul ,100ug/100ul	Human	WB	200ug	59670
CLSDF9395	CLDN23 Antibody	50ug/50ul ,100ug/100ul	Human, Mouse, Rat	WB IHC	200ug	59670
CLSDF9396	CLDN9 Antibody	50ug/50ul ,100ug/100ul	Human, Mouse, Rat	WB	200ug	59670
CLSDF9397	CPSF6 Antibody	50ug/50ul ,100ug/100ul	Human, Mouse	WB	200ug	59670
CLSDF9398	CLASP2 Antibody	50ug/50ul ,100ug/100ul	Human	WB	200ug	59670
CLSDF9399	DENND4A Antibody	50ug/50ul ,100ug/100ul	Human	WB	200ug	59670
CLSDF9400	F11 Antibody	50ug/50ul ,100ug/100ul	Human	WB	200ug	59670
CLSDF9401	F13B Antibody	50ug/50ul ,100ug/100ul	Human	WB	200ug	59670
CLSDF9402	COPG Antibody	50ug/50ul ,100ug/100ul	Human, Mouse, Rat	WB	200ug	59670
CLSDF9403	CCDC109A Antibody	50ug/50ul ,100ug/100ul	Human, Mouse	WB	200ug	59670
CLSDF9404	CCDC131 Antibody	50ug/50ul ,100ug/100ul	Human, Mouse	WB IHC	200ug	59670
CLSDF9405	CCDC8 Antibody	50ug/50ul ,100ug/100ul	Human	WB IHC	200ug	59670
CLSDF9406	C1QTNF8 Antibody	50ug/50ul ,100ug/100ul	Human	WB IHC	200ug	59670
CLSDF9407	C1QTNF9B Antibody	50ug/50ul ,100ug/100ul	Human, Mouse	WB	200ug	59670

Antibodies
HSN : 38220090

Cat#	Product Description	MW	Reactivity	Application	Pack Size	Unit Price
CLSDF9408	C1QL3 Antibody	50ug/50ul ,100ug/100ul	Human, Mouse	WB	200ug	59670
CLSDF9409	C1QL4 Antibody	50ug/50ul ,100ug/100ul	Human, Mouse, Rat	WB IHC	200ug	59670
CLSDF9410	C7 Antibody	50ug/50ul ,100ug/100ul	Human	WB IHC	200ug	59670
CLSDF9411	CFD Antibody	50ug/50ul ,100ug/100ul	Human	WB	200ug	59670
CLSDF9412	CR1 Antibody	50ug/50ul ,100ug/100ul	Human	WB	200ug	59670
CLSDF9413	NCAPD3 Antibody	50ug/50ul ,100ug/100ul	Human	WB	200ug	59670
CLSDF9414	CNTN3 Antibody	50ug/50ul ,100ug/100ul	Human, Mouse, Rat	WB	200ug	59670
CLSDF9415	CNTNAP1 Antibody	50ug/50ul ,100ug/100ul	Human, Mouse	WB	200ug	59670
CLSDF9416	CNTNAP3 Antibody	50ug/50ul ,100ug/100ul	Human	WB IHC	200ug	59670
CLSDF9417	CNTNAP4 Antibody	50ug/50ul ,100ug/100ul	Human, Mouse	WB	200ug	59670
CLSDF9418	HSD11B2 Antibody	50ug/50ul ,100ug/100ul	Human	WB	200ug	59670
CLSDF9419	CNGA3 Antibody	50ug/50ul ,100ug/100ul	Human	WB	200ug	59670
CLSDF9420	CNGB3 Antibody	50ug/50ul ,100ug/100ul	Human	WB	200ug	59670
CLSDF9421	CTH Antibody	50ug/50ul ,100ug/100ul	Human, Mouse	WB	200ug	59670
CLSDF9422	CST8 Antibody	50ug/50ul ,100ug/100ul	Human, Mouse	WB	200ug	59670
CLSDF9423	CST9L2 Antibody	50ug/50ul ,100ug/100ul	Human	WB	200ug	59670
CLSDF9424	CST5 Antibody	50ug/50ul ,100ug/100ul	Human	WB	200ug	59670
CLSDF9425	CST7 Antibody	50ug/50ul ,100ug/100ul	Human	WB IHC	200ug	59670
CLSDF9426	CST6 Antibody	50ug/50ul ,100ug/100ul	Human	WB IHC	200ug	59670
CLSDF9427	DYNC112 Antibody	50ug/50ul ,100ug/100ul	Human, Mouse, Rat	WB IHC	200ug	59670
CLSDF9428	CNDP2 Antibody	50ug/50ul ,100ug/100ul	Human, Mouse, Rat	WB	200ug	59670
CLSDF9429	PLA2G4B Antibody	50ug/50ul ,100ug/100ul	Human, Mouse	WB	200ug	59670
CLSDF9430	PLA2G4F Antibody	50ug/50ul ,100ug/100ul	Human, Mouse	WB IHC	200ug	59670
CLSDF9431	NT5C2 Antibody	50ug/50ul ,100ug/100ul	Human, Mouse	WB IHC	200ug	59670
CLSDF9432	DOCK11 Antibody	50ug/50ul ,100ug/100ul	Human, Mouse, Rat	WB	200ug	59670
CLSDF9433	DOCK7 Antibody	50ug/50ul ,100ug/100ul	Human, Mouse	WB	200ug	59670
CLSDF9434	DHRS1 Antibody	50ug/50ul ,100ug/100ul	Human, Mouse, Rat	WB	200ug	59670
CLSDF9435	DHRS10 Antibody	50ug/50ul ,100ug/100ul	Human	WB	200ug	59670
CLSDF9436	DHRS11 Antibody	50ug/50ul ,100ug/100ul	Human, Mouse	WB	200ug	59670
CLSDF9437	DHRS7 Antibody	50ug/50ul ,100ug/100ul	Human	WB	200ug	59670
CLSDF9438	DHRS9 Antibody	50ug/50ul ,100ug/100ul	Human, Mouse, Rat	WB IHC	200ug	59670
CLSDF9439	DSG3 Antibody	50ug/50ul ,100ug/100ul	Human	WB	200ug	59670
CLSDF9440	DSG4 Antibody	50ug/50ul ,100ug/100ul	Human, Mouse, Rat	WB	200ug	59670
CLSDF9441	ASAP2 Antibody	50ug/50ul ,100ug/100ul	Human, Mouse	WB	200ug	59670
CLSDF9442	DGAT2 Antibody	50ug/50ul ,100ug/100ul	Human, Mouse, Rat	WB	200ug	59670
CLSDF9443	DLG3 Antibody	50ug/50ul ,100ug/100ul	Human, Mouse, Rat	WB	200ug	59670
CLSDF9444	DCLRE1B Antibody	50ug/50ul ,100ug/100ul	Human	WB	200ug	59670
CLSDF9445	APOBEC3H Antibody	50ug/50ul ,100ug/100ul	Human	WB	200ug	59670
CLSDF9446	POLE2 Antibody	50ug/50ul ,100ug/100ul	Human	WB	200ug	59670

Antibodies
HSN : 38220090

Cat#	Product Description	MW	Reactivity	Application	Pack Size	Unit Price
CLSDF9447	POLA2 Antibody	50ug/50ul ,100ug/100ul	Human	WB IHC	200ug	59670
CLSDF9448	POLD4 Antibody	50ug/50ul ,100ug/100ul	Human	WB IHC	200ug	59670
CLSDF9449	POLG1 Antibody	50ug/50ul ,100ug/100ul	Human, Mouse, Rat	WB IHC	200ug	59670
CLSDF9450	GINS1 Antibody	50ug/50ul ,100ug/100ul	Human	WB	200ug	59670
CLSDF9451	GINS2 Antibody	50ug/50ul ,100ug/100ul	Human, Mouse	WB	200ug	59670
CLSDF9452	TOP1MT Antibody	50ug/50ul ,100ug/100ul	Human, Mouse, Rat	WB	200ug	59670
CLSDF9453	DNA2L Antibody	50ug/50ul ,100ug/100ul	Human, Mouse	WB	200ug	59670
CLSDF9454	IGHMBP2 Antibody	50ug/50ul ,100ug/100ul	Human, Mouse, Rat	WB	200ug	59670
CLSDF9455	ZNRD1 Antibody	50ug/50ul ,100ug/100ul	Human, Mouse, Rat	WB IHC	200ug	59670
CLSDF9456	TWISTNB Antibody	50ug/50ul ,100ug/100ul	Human	WB	200ug	59670
CLSDF9457	RPA49 Antibody	50ug/50ul ,100ug/100ul	Human	WB	200ug	59670
CLSDF9458	RPB7 Antibody	50ug/50ul ,100ug/100ul	Human, Mouse, Rat	WB	200ug	59670
CLSDF9459	RPC10 Antibody	50ug/50ul ,100ug/100ul	Human, Mouse, Rat	WB	200ug	59670
CLSDF9460	RPC6 Antibody	50ug/50ul ,100ug/100ul	Human, Mouse	WB	200ug	59670
CLSDF9461	RPC7 Antibody	50ug/50ul ,100ug/100ul	Human	WB	200ug	59670
CLSDF9462	RPC9 Antibody	50ug/50ul ,100ug/100ul	Human	WB	200ug	59670
CLSDF9463	POLRMT Antibody	50ug/50ul ,100ug/100ul	Human	WB	200ug	59670
CLSDF9464	POLR1D Antibody	50ug/50ul ,100ug/100ul	Human	WB IHC	200ug	59670
CLSDF9465	RPAB2 Antibody	50ug/50ul ,100ug/100ul	Human, Mouse, Rat	WB IHC	200ug	59670
CLSDF9466	RPAB3 Antibody	50ug/50ul ,100ug/100ul	Human, Mouse, Rat	WB IHC	200ug	59670
CLSDF9467	RPAB4 Antibody	50ug/50ul ,100ug/100ul	Human, Mouse	WB	200ug	59670
CLSDF9468	DCTN4 Antibody	50ug/50ul ,100ug/100ul	Human, Mouse, Rat	WB	200ug	59670
CLSDF9469	DYNC1H1 Antibody	50ug/50ul ,100ug/100ul	Human, Mouse, Rat	WB IHC	200ug	59670
CLSDF9470	DNAL4 Antibody	50ug/50ul ,100ug/100ul	Human, Mouse	WB IHC	200ug	59670
CLSDF9471	DYNLRB1 Antibody	50ug/50ul ,100ug/100ul	Human, Mouse, Rat	WB	200ug	59670
CLSDF9472	DYNLRB2 Antibody	50ug/50ul ,100ug/100ul	Human, Mouse	WB	200ug	59670
CLSDF9473	DYNLT1 Antibody	50ug/50ul ,100ug/100ul	Human	WB	200ug	59670
CLSDF9474	DYNLT3 Antibody	50ug/50ul ,100ug/100ul	Human	WB	200ug	59670
CLSDF9475	NSMCE2 Antibody	50ug/50ul ,100ug/100ul	Human	WB	200ug	59670
CLSDF9476	FANCL Antibody	50ug/50ul ,100ug/100ul	Human, Mouse, Rat	WB	200ug	59670
CLSDF9477	HACE1 Antibody	50ug/50ul ,100ug/100ul	Human, Mouse, Rat	WB IHC	200ug	59670
CLSDF9478	HECTD1 Antibody	50ug/50ul ,100ug/100ul	Human, Mouse, Rat	WB	200ug	59670
CLSDF9479	HECW1 Antibody	50ug/50ul ,100ug/100ul	Human	WB	200ug	59670
CLSDF9480	LRSAM1 Antibody	50ug/50ul ,100ug/100ul	Human, Mouse, Rat	WB	200ug	59670
CLSDF9481	MARCH1 Antibody	50ug/50ul ,100ug/100ul	Human	WB	200ug	59670
CLSDF9482	MARCH6 Antibody	50ug/50ul ,100ug/100ul	Human, Mouse	WB	200ug	59670
CLSDF9483	MARCH7 Antibody	50ug/50ul ,100ug/100ul	Human	WB	200ug	59670
CLSDF9484	MARCH8 Antibody	50ug/50ul ,100ug/100ul	Human	WB	200ug	59670
CLSDF9485	MARCH9 Antibody	50ug/50ul ,100ug/100ul	Human, Mouse	WB	200ug	59670

Antibodies
HSN : 38220090

Cat#	Product Description	MW	Reactivity	Application	Pack Size	Unit Price
CLSDF9486	RNF41 Antibody	50ug/50ul ,100ug/100ul	Human, Mouse, Rat	WB IHC	200ug	59670
CLSDF9487	PJA1 Antibody	50ug/50ul ,100ug/100ul	Human	WB IHC	200ug	59670
CLSDF9488	RNF123 Antibody	50ug/50ul ,100ug/100ul	Human, Mouse	WB IHC	200ug	59670
CLSDF9489	RNF167 Antibody	50ug/50ul ,100ug/100ul	Human, Mouse, Rat	WB	200ug	59670
CLSDF9490	RNF5 Antibody	50ug/50ul ,100ug/100ul	Human, Mouse, Rat	WB	200ug	59670
CLSDF9491	UBR2 Antibody	50ug/50ul ,100ug/100ul	Human, Mouse	WB IHC	200ug	59670
CLSDF9492	ZNRF1 Antibody	50ug/50ul ,100ug/100ul	Human, Mouse	WB IHC	200ug	59670
CLSDF9493	EEF1A2 Antibody	50ug/50ul ,100ug/100ul	Human, Mouse, Rat	WB	200ug	59670
CLSDF9494	GFM1 Antibody	50ug/50ul ,100ug/100ul	Human	WB	200ug	59670
CLSDF9495	ELOVL2 Antibody	50ug/50ul ,100ug/100ul	Human	WB	200ug	59670
CLSDF9496	ELP3 Antibody	50ug/50ul ,100ug/100ul	Human, Mouse	WB	200ug	59670
CLSDF9497	ENDOD1 Antibody	50ug/50ul ,100ug/100ul	Human, Mouse	WB	200ug	59670
CLSDF9498	NTHL1 Antibody	50ug/50ul ,100ug/100ul	Human, Mouse	WB	200ug	59670
CLSDF9499	NEIL2 Antibody	50ug/50ul ,100ug/100ul	Human, Mouse	WB IHC	200ug	59670
CLSDF9500	CD248 Antibody	50ug/50ul ,100ug/100ul	Human, Mouse	WB	200ug	59670
CLSDF9501	EDC4 Antibody	50ug/50ul ,100ug/100ul	Human, Mouse, Rat	WB	200ug	59670
CLSDF9502	EDEM1 Antibody	50ug/50ul ,100ug/100ul	Human, Mouse	WB	200ug	59670
CLSDF9503	EDEM2 Antibody	50ug/50ul ,100ug/100ul	Human	WB	200ug	59670
CLSDF9504	EDEM3 Antibody	50ug/50ul ,100ug/100ul	Human, Mouse	WB	200ug	59670
CLSDF9505	HSD17B12 Antibody	50ug/50ul ,100ug/100ul	Human	WB	200ug	59670
CLSDF9506	HSD17B8 Antibody	50ug/50ul ,100ug/100ul	Human	WB	200ug	59670
CLSDF9507	EIF1B Antibody	50ug/50ul ,100ug/100ul	Human, Mouse, Rat	WB	200ug	59670
CLSDF9508	EIF2C3 Antibody	50ug/50ul ,100ug/100ul	Human, Mouse	WB IHC	200ug	59670
CLSDF9509	EIF3J Antibody	50ug/50ul ,100ug/100ul	Human, Mouse, Rat	WB IHC	200ug	59670
CLSDF9510	EIF3A Antibody	50ug/50ul ,100ug/100ul	Human, Mouse, Rat	WB IHC	200ug	59670
CLSDF9511	EIF5 Antibody	50ug/50ul ,100ug/100ul	Human, Mouse, Rat	WB	200ug	59670
CLSDF9512	ETAA1 Antibody	50ug/50ul ,100ug/100ul	Human	WB	200ug	59670
CLSDF9513	FANCM Antibody	50ug/50ul ,100ug/100ul	Human	WB IHC	200ug	59670
CLSDF9514	KHSRP Antibody	50ug/50ul ,100ug/100ul	Human, Mouse, Rat	WB IHC	200ug	59670
CLSDF9515	FAIM2 Antibody	50ug/50ul ,100ug/100ul	Human	WB	200ug	59670
CLSDF9516	FBLN1 Antibody	50ug/50ul ,100ug/100ul	Human, Mouse, Rat	WB IHC	200ug	59670
CLSDF9517	FIGNL1 Antibody	50ug/50ul ,100ug/100ul	Human	WB	200ug	59670
CLSDF9518	FOLR2 Antibody	50ug/50ul ,100ug/100ul	Human, Mouse	WB	200ug	59670
CLSDF9519	FOLR3 Antibody	50ug/50ul ,100ug/100ul	Human	WB	200ug	59670
CLSDF9520	FOXD4L5 Antibody	50ug/50ul ,100ug/100ul	Human	WB	200ug	59670
CLSDF9521	FNBP4 Antibody	50ug/50ul ,100ug/100ul	Human, Mouse	WB	200ug	59670
CLSDF9522	GPATCH8 Antibody	50ug/50ul ,100ug/100ul	Human	WB IHC	200ug	59670
CLSDF9523	FUT2 Antibody	50ug/50ul ,100ug/100ul	Human	WB	200ug	59670
CLSDF9524	GABRE Antibody	50ug/50ul ,100ug/100ul	Human	WB	200ug	59670

Antibodies

HSN : 38220090

Cat#	Product Description	MW	Reactivity	Application	Pack Size	Unit Price
CLSDF9525	GABRR1 Antibody	50ug/50ul ,100ug/100ul	Human	WB	200ug	59670
CLSDF9526	GABRR2 Antibody	50ug/50ul ,100ug/100ul	Human, Mouse, Rat	WB	200ug	59670
CLSDF9527	TUBGCP2 Antibody	50ug/50ul ,100ug/100ul	Human, Mouse, Rat	WB	200ug	59670
CLSDF9528	GJB5 Antibody	50ug/50ul ,100ug/100ul	Human, Mouse, Rat	WB	200ug	59670
CLSDF9529	GFCF1 Antibody	50ug/50ul ,100ug/100ul	Human, Mouse	WB	200ug	59670
CLSDF9530	GMDS Antibody	50ug/50ul ,100ug/100ul	Human, Mouse, Rat	WB	200ug	59670
CLSDF9531	GPHN Antibody	50ug/50ul ,100ug/100ul	Human	WB IHC	200ug	59670
CLSDF9532	FGF9 Antibody	50ug/50ul ,100ug/100ul	Human, Mouse, Rat	WB IHC	200ug	59670
CLSDF9533	QSER1 Antibody	50ug/50ul ,100ug/100ul	Human	WB IHC	200ug	59670
CLSDF9534	PTGDS2 Antibody	50ug/50ul ,100ug/100ul	Human	WB	200ug	59670
CLSDF9535	GAPDHS Antibody	50ug/50ul ,100ug/100ul	Human	WB	200ug	59670
CLSDF9536	GORASP1 Antibody	50ug/50ul ,100ug/100ul	Human, Mouse, Rat	WB IHC	200ug	59670
CLSDF9537	GON4L Antibody	50ug/50ul ,100ug/100ul	Human	WB IHC	200ug	59670
CLSDF9538	GASP2 Antibody	50ug/50ul ,100ug/100ul	Human	WB	200ug	59670
CLSDF9539	GPSP1 Antibody	50ug/50ul ,100ug/100ul	Human, Mouse, Rat	WB IHC	200ug	59670
CLSDF9540	GPSP2 Antibody	50ug/50ul ,100ug/100ul	Human, Mouse, Rat	WB	200ug	59670
CLSDF9541	GPSP3 Antibody	50ug/50ul ,100ug/100ul	Human, Mouse, Rat	WB	200ug	59670
CLSDF9542	CSF3 Antibody	50ug/50ul ,100ug/100ul	Human	WB	200ug	59670
CLSDF9543	CSF3R Antibody	50ug/50ul ,100ug/100ul	Human	WB	200ug	59670
CLSDF9544	GDF6 Antibody	50ug/50ul ,100ug/100ul	Human, Mouse, Rat	WB	200ug	59670
CLSDF9545	GAS8 Antibody	50ug/50ul ,100ug/100ul	Human, Mouse, Rat	WB IHC	200ug	59670
CLSDF9546	GCH1 Antibody	50ug/50ul ,100ug/100ul	Human, Mouse, Rat	WB	200ug	59670
CLSDF9547	GIMAP7 Antibody	50ug/50ul ,100ug/100ul	Human	WB	200ug	59670
CLSDF9548	RALGAPA1 Antibody	50ug/50ul ,100ug/100ul	Human, Mouse, Rat	WB	200ug	59670
CLSDF9549	GTPBP1 Antibody	50ug/50ul ,100ug/100ul	Human, Mouse, Rat	WB	200ug	59670
CLSDF9550	GTPBP5 Antibody	50ug/50ul ,100ug/100ul	Human, Mouse, Rat	WB	200ug	59670
CLSDF9551	TRIM23 Antibody	50ug/50ul ,100ug/100ul	Human, Mouse, Rat	WB	200ug	59670
CLSDF9552	DIRAS2 Antibody	50ug/50ul ,100ug/100ul	Human, Mouse, Rat	WB	200ug	59670
CLSDF9553	Antibody	50ug/50ul ,100ug/100ul	Human, Mouse, Rat	WB	200ug	59670
CLSDF9554	SAR1A Antibody	50ug/50ul ,100ug/100ul	Human, Mouse, Rat	WB IHC	200ug	59670
CLSDF9555	MSS4 Antibody	50ug/50ul ,100ug/100ul	Human, Mouse, Rat	WB IHC	200ug	59670
CLSDF9556	GNG12 Antibody	50ug/50ul ,100ug/100ul	Human, Mouse	WB IHC	200ug	59670
CLSDF9557	GNG13 Antibody	50ug/50ul ,100ug/100ul	Human, Mouse	WB	200ug	59670
CLSDF9558	GNG2 Antibody	50ug/50ul ,100ug/100ul	Human, Mouse	WB	200ug	59670
CLSDF9559	GNG3 Antibody	50ug/50ul ,100ug/100ul	Human, Mouse	WB	200ug	59670
CLSDF9560	GNG4 Antibody	50ug/50ul ,100ug/100ul	Human, Mouse	WB	200ug	59670
CLSDF9561	GNG5 Antibody	50ug/50ul ,100ug/100ul	Human, Mouse, Rat	WB IHC	200ug	59670
CLSDF9562	GNG7 Antibody	50ug/50ul ,100ug/100ul	Human, Mouse, Rat	WB	200ug	59670
CLSDF9563	GNG8 Antibody	50ug/50ul ,100ug/100ul	Human, Mouse, Rat	WB	200ug	59670

Antibodies
HSN : 38220090

Cat#	Product Description	MW	Reactivity	Application	Pack Size	Unit Price
CLSDF9564	GNB1 Antibody	50ug/50ul ,100ug/100ul	Human, Mouse, Rat	WB	200ug	59670
CLSDF9565	GNB3 Antibody	50ug/50ul ,100ug/100ul	Human, Mouse, Rat	WB	200ug	59670
CLSDF9566	GNL3 Antibody	50ug/50ul ,100ug/100ul	Human, Mouse, Rat	WB	200ug	59670
CLSDF9567	GUCA2B Antibody	50ug/50ul ,100ug/100ul	Human	WB	200ug	59670
CLSDF9568	GBP5 Antibody	50ug/50ul ,100ug/100ul	Human	WB	200ug	59670
CLSDF9569	HEATR1 Antibody	50ug/50ul ,100ug/100ul	Human	WB	200ug	59670
CLSDF9570	HGFAC Antibody	50ug/50ul ,100ug/100ul	Human, Mouse, Rat	WB IHC	200ug	59670
CLSDF9571	HNRPD Antibody	50ug/50ul ,100ug/100ul	Human, Mouse, Rat	WB IHC	200ug	59670
CLSDF9572	HLA-DMA Antibody	50ug/50ul ,100ug/100ul	Human	WB IHC	200ug	59670
CLSDF9573	HLA-DMB Antibody	50ug/50ul ,100ug/100ul	Human	WB	200ug	59670
CLSDF9574	HLA-DQB2 Antibody	50ug/50ul ,100ug/100ul	Human	WB	200ug	59670
CLSDF9575	HOXA11 Antibody	50ug/50ul ,100ug/100ul	Human, Mouse, Rat	WB IHC	200ug	59670
CLSDF9576	HOXB1 Antibody	50ug/50ul ,100ug/100ul	Human	WB IHC	200ug	59670
CLSDF9577	HOXB3 Antibody	50ug/50ul ,100ug/100ul	Human, Mouse, Rat	WB	200ug	59670
CLSDF9578	HOXB8 Antibody	50ug/50ul ,100ug/100ul	Human, Mouse, Rat	WB	200ug	59670
CLSDF9579	HOXC10 Antibody	50ug/50ul ,100ug/100ul	Human, Mouse	WB	200ug	59670
CLSDF9580	HOXC11 Antibody	50ug/50ul ,100ug/100ul	Human, Mouse, Rat	WB	200ug	59670
CLSDF9581	HOXC12 Antibody	50ug/50ul ,100ug/100ul	Human, Mouse, Rat	WB	200ug	59670
CLSDF9582	HOXC13 Antibody	50ug/50ul ,100ug/100ul	Human, Mouse, Rat	WB IHC	200ug	59670
CLSDF9583	HOXC9 Antibody	50ug/50ul ,100ug/100ul	Human, Mouse, Rat	WB	200ug	59670
CLSDF9584	HOXD11 Antibody	50ug/50ul ,100ug/100ul	Human, Mouse, Rat	WB	200ug	59670
CLSDF9585	HOXD13 Antibody	50ug/50ul ,100ug/100ul	Human, Mouse	WB	200ug	59670
CLSDF9586	HOXD9 Antibody	50ug/50ul ,100ug/100ul	Human, Mouse, Rat	WB	200ug	59670
CLSDF9587	NKX22 Antibody	50ug/50ul ,100ug/100ul	Human, Mouse, Rat	WB	200ug	59670
CLSDF9588	NKX23 Antibody	50ug/50ul ,100ug/100ul	Human, Mouse, Rat	WB	200ug	59670
CLSDF9589	NKX61 Antibody	50ug/50ul ,100ug/100ul	Human, Mouse, Rat	WB	200ug	59670
CLSDF9590	NKX62 Antibody	50ug/50ul ,100ug/100ul	Human, Mouse, Rat	WB	200ug	59670
CLSDF9591	SIX3 Antibody	50ug/50ul ,100ug/100ul	Human, Mouse, Rat	WB IHC	200ug	59670
CLSDF9592	SIX4 Antibody	50ug/50ul ,100ug/100ul	Human, Mouse, Rat	WB IHC	200ug	59670
CLSDF9593	TGIF2LX Antibody	50ug/50ul ,100ug/100ul	Human, Mouse, Rat	WB IHC	200ug	59670
CLSDF9594	VPREB1 Antibody	50ug/50ul ,100ug/100ul	Human	WB	200ug	59670
CLSDF9595	USP54 Antibody	50ug/50ul ,100ug/100ul	Human, Mouse, Rat	WB	200ug	59670
CLSDF9596	ICAM5 Antibody	50ug/50ul ,100ug/100ul	Human	WB IHC	200ug	59670
CLSDF9597	KCNJ13 Antibody	50ug/50ul ,100ug/100ul	Human	WB IHC	200ug	59670
CLSDF9598	KHDRBS3 Antibody	50ug/50ul ,100ug/100ul	Human, Mouse, Rat	WB	200ug	59670
CLSDF9599	KIR2DL2 Antibody	50ug/50ul ,100ug/100ul	Human	WB	200ug	59670
CLSDF9600	KIR2DL5A Antibody	50ug/50ul ,100ug/100ul	Human	WB	200ug	59670
CLSDF9601	KIR2DS5 Antibody	50ug/50ul ,100ug/100ul	Human	WB	200ug	59670
CLSDF9602	A4GALT Antibody	50ug/50ul ,100ug/100ul	Human, Mouse, Rat	WB	200ug	59670

Antibodies
HSN : 38220090

Cat#	Product Description	MW	Reactivity	Application	Pack Size	Unit Price
CLSDF9603	LILRB1 Antibody	50ug/50ul ,100ug/100ul	Human	WB	200ug	59670
CLSDF9604	LILRB2 Antibody	50ug/50ul ,100ug/100ul	Human, Mouse, Rat	WB IHC	200ug	59670
CLSDF9605	ACSL1 Antibody	50ug/50ul ,100ug/100ul	Human, Mouse, Rat	WB	200ug	59670
CLSDF9606	ACSL3 Antibody	50ug/50ul ,100ug/100ul	Human, Mouse, Rat	WB	200ug	59670
CLSDF9607	ACSL5 Antibody	50ug/50ul ,100ug/100ul	Human, Mouse, Rat	WB	200ug	59670
CLSDF9608	LRP12 Antibody	50ug/50ul ,100ug/100ul	Human	WB	200ug	59670
CLSDF9609	LRP1B Antibody	50ug/50ul ,100ug/100ul	Human, Mouse	WB	200ug	59670
CLSDF9610	LRP4 Antibody	50ug/50ul ,100ug/100ul	Human, Mouse, Rat	WB	200ug	59670
CLSDF9611	MARVELD2 Antibody	50ug/50ul ,100ug/100ul	Human, Mouse, Rat	WB	200ug	59670
CLSDF9612	MED11 Antibody	50ug/50ul ,100ug/100ul	Human, Mouse, Rat	WB	200ug	59670
CLSDF9613	MED15 Antibody	50ug/50ul ,100ug/100ul	Human, Mouse, Rat	WB IHC	200ug	59670
CLSDF9614	MED22 Antibody	50ug/50ul ,100ug/100ul	Human, Mouse, Rat	WB IHC	200ug	59670
CLSDF9615	MED28 Antibody	50ug/50ul ,100ug/100ul	Human, Mouse, Rat	WB IHC	200ug	59670
CLSDF9616	MED29 Antibody	50ug/50ul ,100ug/100ul	Human, Mouse	WB	200ug	59670
CLSDF9617	MED30 Antibody	50ug/50ul ,100ug/100ul	Human, Mouse, Rat	WB	200ug	59670
CLSDF9618	MED31 Antibody	50ug/50ul ,100ug/100ul	Human, Mouse, Rat	WB	200ug	59670
CLSDF9619	MED4 Antibody	50ug/50ul ,100ug/100ul	Human, Mouse, Rat	WB	200ug	59670
CLSDF9620	MED9 Antibody	50ug/50ul ,100ug/100ul	Human, Mouse	WB	200ug	59670
CLSDF9621	MRAP Antibody	50ug/50ul ,100ug/100ul	Human	WB IHC	200ug	59670
CLSDF9622	MIA3 Antibody	50ug/50ul ,100ug/100ul	Human, Mouse, Rat	WB	200ug	59670
CLSDF9623	MAP1A Antibody	50ug/50ul ,100ug/100ul	Human, Mouse, Rat	WB	200ug	59670
CLSDF9624	MID1IP1 Antibody	50ug/50ul ,100ug/100ul	Human, Mouse, Rat	WB	200ug	59670
CLSDF9625	MRPS28 Antibody	50ug/50ul ,100ug/100ul	Human, Mouse, Rat	WB	200ug	59670
CLSDF9626	MRPL23 Antibody	50ug/50ul ,100ug/100ul	Human, Mouse, Rat	WB	200ug	59670
CLSDF9627	MRPL27 Antibody	50ug/50ul ,100ug/100ul	Human, Mouse, Rat	WB	200ug	59670
CLSDF9628	MRPL33 Antibody	50ug/50ul ,100ug/100ul	Human	WB	200ug	59670
CLSDF9629	IMMP1L Antibody	50ug/50ul ,100ug/100ul	Human, Mouse	WB	200ug	59670
CLSDF9630	IMMP2L Antibody	50ug/50ul ,100ug/100ul	Human, Mouse	WB IHC	200ug	59670
CLSDF9631	C3orf31 Antibody	50ug/50ul ,100ug/100ul	Human, Mouse	WB IHC	200ug	59670
CLSDF9632	MOT11 Antibody	50ug/50ul ,100ug/100ul	Human, Mouse, Rat	WB IHC	200ug	59670
CLSDF9633	MOT2 Antibody	50ug/50ul ,100ug/100ul	Human, Mouse, Rat	WB	200ug	59670
CLSDF9634	MOT6 Antibody	50ug/50ul ,100ug/100ul	Human, Mouse, Rat	WB	200ug	59670
CLSDF9635	MOT7 Antibody	50ug/50ul ,100ug/100ul	Human, Mouse, Rat	WB IHC	200ug	59670
CLSDF9636	MOT9 Antibody	50ug/50ul ,100ug/100ul	Human	WB IHC	200ug	59670
CLSDF9637	MPHOSPH8 Antibody	50ug/50ul ,100ug/100ul	Human, Mouse, Rat	WB	200ug	59670
CLSDF9638	MUC4 Antibody	50ug/50ul ,100ug/100ul	Human	WB	200ug	59670
CLSDF9639	MUC5A Antibody	50ug/50ul ,100ug/100ul	Human	WB	200ug	59670
CLSDF9640	MUC5B Antibody	50ug/50ul ,100ug/100ul	Human	WB	200ug	59670
CLSDF9641	MUC6 Antibody	50ug/50ul ,100ug/100ul	Human, Mouse	WB	200ug	59670

Antibodies
HSN : 38220090

Cat#	Product Description	MW	Reactivity	Application	Pack Size	Unit Price
CLSDF9642	MUC7 Antibody	50ug/50ul ,100ug/100ul	Human	WB	200ug	59670
CLSDF9643	MRP6 Antibody	50ug/50ul ,100ug/100ul	Human, Mouse, Rat	WB IHC	200ug	59670
CLSDF9644	MEGF6 Antibody	50ug/50ul ,100ug/100ul	Human, Mouse, Rat	WB	200ug	59670
CLSDF9645	MAL Antibody	50ug/50ul ,100ug/100ul	Human, Mouse, Rat	WB	200ug	59670
CLSDF9646	MLL2 Antibody	50ug/50ul ,100ug/100ul	Human	WB	200ug	59670
CLSDF9647	MYH3 Antibody	50ug/50ul ,100ug/100ul	Human, Mouse, Rat	WB	200ug	59670
CLSDF9648	MYH8 Antibody	50ug/50ul ,100ug/100ul	Human	WB	200ug	59670
CLSDF9649	MYBPC2 Antibody	50ug/50ul ,100ug/100ul	Human	WB	200ug	59670
CLSDF9650	MYO1A Antibody	50ug/50ul ,100ug/100ul	Human, Mouse, Rat	WB	200ug	59670
CLSDF9651	MYO1B Antibody	50ug/50ul ,100ug/100ul	Human, Mouse, Rat	WB	200ug	59670
CLSDF9652	MYO3B Antibody	50ug/50ul ,100ug/100ul	Human	WB IHC	200ug	59670
CLSDF9653	MYO5C Antibody	50ug/50ul ,100ug/100ul	Human, Mouse, Rat	WB IHC	200ug	59670
CLSDF9654	MYO6 Antibody	50ug/50ul ,100ug/100ul	Human, Mouse, Rat	WB IHC	200ug	59670
CLSDF9655	MYO7A Antibody	50ug/50ul ,100ug/100ul	Human, Mouse, Rat	WB	200ug	59670
CLSDF9656	MYO16 Antibody	50ug/50ul ,100ug/100ul	Human	WB	200ug	59670
CLSDF9657	ESCO1 Antibody	50ug/50ul ,100ug/100ul	Human	WB IHC	200ug	59670
CLSDF9658	NNT Antibody	50ug/50ul ,100ug/100ul	Human, Mouse, Rat	WB IHC	200ug	59670
CLSDF9659	NDUFA1 Antibody	50ug/50ul ,100ug/100ul	Human, Mouse, Rat	WB	200ug	59670
CLSDF9660	NDUFA5 Antibody	50ug/50ul ,100ug/100ul	Human, Mouse	WB	200ug	59670
CLSDF9661	NDUFA6 Antibody	50ug/50ul ,100ug/100ul	Human, Mouse, Rat	WB	200ug	59670
CLSDF9662	NDUFA7 Antibody	50ug/50ul ,100ug/100ul	Human, Mouse, Rat	WB	200ug	59670
CLSDF9663	NDUFB3 Antibody	50ug/50ul ,100ug/100ul	Human, Mouse, Rat	WB	200ug	59670
CLSDF9664	NDUFB5 Antibody	50ug/50ul ,100ug/100ul	Human, Mouse, Rat	WB	200ug	59670
CLSDF9665	NDUFB7 Antibody	50ug/50ul ,100ug/100ul	Human, Mouse	WB IHC	200ug	59670
CLSDF9666	NDUFB8 Antibody	50ug/50ul ,100ug/100ul	Human, Mouse, Rat	WB	200ug	59670
CLSDF9667	NDUFC1 Antibody	50ug/50ul ,100ug/100ul	Human, Mouse	WB	200ug	59670
CLSDF9668	NDUFV1 Antibody	50ug/50ul ,100ug/100ul	Human, Mouse, Rat	WB	200ug	59670
CLSDF9669	NDUFS2 Antibody	50ug/50ul ,100ug/100ul	Human, Mouse, Rat	WB	200ug	59670
CLSDF9670	NDUFS4 Antibody	50ug/50ul ,100ug/100ul	Human, Mouse, Rat	WB	200ug	59670
CLSDF9671	NDUFS6 Antibody	50ug/50ul ,100ug/100ul	Human, Mouse, Rat	WB	200ug	59670
CLSDF9672	NDUFS8 Antibody	50ug/50ul ,100ug/100ul	Human, Mouse, Rat	WB	200ug	59670
CLSDF9673	CYB5R2 Antibody	50ug/50ul ,100ug/100ul	Human, Mouse, Rat	WB	200ug	59670
CLSDF9674	MT-ND2 Antibody	50ug/50ul ,100ug/100ul	Human	WB IHC	200ug	59670
CLSDF9675	MT-ND4L Antibody	50ug/50ul ,100ug/100ul	Human	WB IHC	200ug	59670
CLSDF9676	MT-ND6 Antibody	50ug/50ul ,100ug/100ul	Human, Mouse, Rat	WB IHC	200ug	59670
CLSDF9677	NCR2 Antibody	50ug/50ul ,100ug/100ul	Human	WB	200ug	59670
CLSDF9678	NPHP1 Antibody	50ug/50ul ,100ug/100ul	Human, Mouse	WB	200ug	59670
CLSDF9679	UNC5A Antibody	50ug/50ul ,100ug/100ul	Human, Mouse, Rat	WB IHC	200ug	59670
CLSDF9680	NGRN Antibody	50ug/50ul ,100ug/100ul	Human	WB IHC	200ug	59670

Antibodies
HSN : 38220090

Cat#	Product Description	MW	Reactivity	Application	Pack Size	Unit Price
CLSDF9681	NRSN2 Antibody	50ug/50ul ,100ug/100ul	Human	WB	200ug	59670
CLSDF9682	NRXN3 Antibody	50ug/50ul ,100ug/100ul	Human, Mouse, Rat	WB IHC	200ug	59670
CLSDF9683	NXP2 Antibody	50ug/50ul ,100ug/100ul	Human, Mouse	WB	200ug	59670
CLSDF9684	NBPF3 Antibody	50ug/50ul ,100ug/100ul	Human	WB	200ug	59670
CLSDF9685	NBPF6 Antibody	50ug/50ul ,100ug/100ul	Human	WB	200ug	59670
CLSDF9686	NBAS Antibody	50ug/50ul ,100ug/100ul	Human	WB	200ug	59670
CLSDF9687	NCALD Antibody	50ug/50ul ,100ug/100ul	Human, Mouse, Rat	WB	200ug	59670
CLSDF9688	SCG5 Antibody	50ug/50ul ,100ug/100ul	Human, Mouse, Rat	WB IHC	200ug	59670
CLSDF9689	NEUROD4 Antibody	50ug/50ul ,100ug/100ul	Human, Mouse, Rat	WB	200ug	59670
CLSDF9690	NLGN1 Antibody	50ug/50ul ,100ug/100ul	Human, Mouse, Rat	WB	200ug	59670
CLSDF9691	NLGN2 Antibody	50ug/50ul ,100ug/100ul	Human, Mouse, Rat	WB	200ug	59670
CLSDF9692	NLGN3 Antibody	50ug/50ul ,100ug/100ul	Human, Mouse, Rat	WB	200ug	59670
CLSDF9693	NMB Antibody	50ug/50ul ,100ug/100ul	Human, Mouse, Rat	WB	200ug	59670
CLSDF9694	NAV1 Antibody	50ug/50ul ,100ug/100ul	Human, Mouse	WB	200ug	59670
CLSDF9695	NAV2 Antibody	50ug/50ul ,100ug/100ul	Human	WB	200ug	59670
CLSDF9696	NAV3 Antibody	50ug/50ul ,100ug/100ul	Human	WB	200ug	59670
CLSDF9697	CHRN3 Antibody	50ug/50ul ,100ug/100ul	Human, Mouse, Rat	WB IHC	200ug	59670
CLSDF9698	CHRN4 Antibody	50ug/50ul ,100ug/100ul	Human, Mouse, Rat	WB IHC	200ug	59670
CLSDF9699	GPM6A Antibody	50ug/50ul ,100ug/100ul	Human, Mouse, Rat	WB IHC	200ug	59670
CLSDF9700	GPM6B Antibody	50ug/50ul ,100ug/100ul	Human, Mouse, Rat	WB	200ug	59670
CLSDF9701	NPAS2 Antibody	50ug/50ul ,100ug/100ul	Human	WB	200ug	59670
CLSDF9702	NPS Antibody	50ug/50ul ,100ug/100ul	Human	WB IHC	200ug	59670
CLSDF9703	NTS Antibody	50ug/50ul ,100ug/100ul	Human, Mouse, Rat	WB IHC	200ug	59670
CLSDF9704	NID2 Antibody	50ug/50ul ,100ug/100ul	Human	WB	200ug	59670
CLSDF9705	DFNA5 Antibody	50ug/50ul ,100ug/100ul	Human	WB IHC	200ug	59670
CLSDF9706	NUP133 Antibody	50ug/50ul ,100ug/100ul	Human, Mouse, Rat	WB	200ug	59670
CLSDF9707	NUP153 Antibody	50ug/50ul ,100ug/100ul	Human, Mouse, Rat	WB	200ug	59670
CLSDF9708	NUP155 Antibody	50ug/50ul ,100ug/100ul	Human, Mouse, Rat	WB	200ug	59670
CLSDF9709	NUP205 Antibody	50ug/50ul ,100ug/100ul	Human, Mouse, Rat	WB	200ug	59670
CLSDF9710	NUP214 Antibody	50ug/50ul ,100ug/100ul	Human, Mouse	WB	200ug	59670
CLSDF9711	NUP88 Antibody	50ug/50ul ,100ug/100ul	Human, Mouse	WB IHC	200ug	59670
CLSDF9712	NUP210L Antibody	50ug/50ul ,100ug/100ul	Human	WB	200ug	59670
CLSDF9713	TNP2 Antibody	50ug/50ul ,100ug/100ul	Human	WB	200ug	59670
CLSDF9714	NVL Antibody	50ug/50ul ,100ug/100ul	Human, Mouse, Rat	WB	200ug	59670
CLSDF9715	SC65 Antibody	50ug/50ul ,100ug/100ul	Human, Mouse, Rat	WB	200ug	59670
CLSDF9716	NOL11 Antibody	50ug/50ul ,100ug/100ul	Human, Mouse, Rat	WB	200ug	59670
CLSDF9717	NOL12 Antibody	50ug/50ul ,100ug/100ul	Human, Mouse, Rat	WB	200ug	59670
CLSDF9718	NOL14 Antibody	50ug/50ul ,100ug/100ul	Human, Mouse, Rat	WB	200ug	59670
CLSDF9719	NOL4 Antibody	50ug/50ul ,100ug/100ul	Human, Mouse, Rat	WB	200ug	59670

Antibodies
HSN : 38220090

Cat#	Product Description	MW	Reactivity	Application	Pack Size	Unit Price
CLSDF9720	NOL7 Antibody	50ug/50ul ,100ug/100ul	Human, Mouse, Rat	WB IHC	200ug	59670
CLSDF9721	NOL9 Antibody	50ug/50ul ,100ug/100ul	Human, Mouse, Rat	WB IHC	200ug	59670
CLSDF9722	ZCCHC17 Antibody	50ug/50ul ,100ug/100ul	Human, Mouse	WB IHC	200ug	59670
CLSDF9723	OR6N1 Antibody	50ug/50ul ,100ug/100ul	Human	WB	200ug	59670
CLSDF9724	SLC22A4 Antibody	50ug/50ul ,100ug/100ul	Human	WB	200ug	59670
CLSDF9725	OAZ2 Antibody	50ug/50ul ,100ug/100ul	Human, Mouse, Rat	WB IHC	200ug	59670
CLSDF9726	OAZ3 Antibody	50ug/50ul ,100ug/100ul	Human	WB	200ug	59670
CLSDF9727	SLC6A17 Antibody	50ug/50ul ,100ug/100ul	Human, Mouse, Rat	WB	200ug	59670
CLSDF9728	P2RX1 Antibody	50ug/50ul ,100ug/100ul	Human, Mouse, Rat	WB	200ug	59670
CLSDF9729	PRRX2 Antibody	50ug/50ul ,100ug/100ul	Human, Mouse, Rat	WB IHC	200ug	59670
CLSDF9730	PHOX2B Antibody	50ug/50ul ,100ug/100ul	Human, Mouse	WB	200ug	59670
CLSDF9731	PALLD Antibody	50ug/50ul ,100ug/100ul	Human, Mouse	WB	200ug	59670
CLSDF9732	ZDHHC18 Antibody	50ug/50ul ,100ug/100ul	Human, Mouse, Rat	WB	200ug	59670
CLSDF9733	CROT Antibody	50ug/50ul ,100ug/100ul	Human, Mouse, Rat	WB	200ug	59670
CLSDF9734	PEX11A Antibody	50ug/50ul ,100ug/100ul	Human, Mouse, Rat	WB	200ug	59670
CLSDF9735	HSD17B4 Antibody	50ug/50ul ,100ug/100ul	Human	WB	200ug	59670
CLSDF9736	PAOX Antibody	50ug/50ul ,100ug/100ul	Human	WB	200ug	59670
CLSDF9737	PEX5 Antibody	50ug/50ul ,100ug/100ul	Human, Mouse	WB	200ug	59670
CLSDF9738	PEX6 Antibody	50ug/50ul ,100ug/100ul	Human, Mouse, Rat	WB IHC	200ug	59670
CLSDF9739	PEX12 Antibody	50ug/50ul ,100ug/100ul	Human, Mouse, Rat	WB IHC	200ug	59670
CLSDF9740	PREX1 Antibody	50ug/50ul ,100ug/100ul	Human, Mouse, Rat	WB IHC	200ug	59670
CLSDF9741	INPP5J Antibody	50ug/50ul ,100ug/100ul	Human, Rat	WB	200ug	59670
CLSDF9742	PIGA Antibody	50ug/50ul ,100ug/100ul	Human, Mouse, Rat	WB	200ug	59670
CLSDF9743	PIGC Antibody	50ug/50ul ,100ug/100ul	Human, Mouse, Rat	WB IHC	200ug	59670
CLSDF9744	PIGP Antibody	50ug/50ul ,100ug/100ul	Human, Mouse	WB IHC	200ug	59670
CLSDF9745	PIGQ Antibody	50ug/50ul ,100ug/100ul	Human, Mouse, Rat	WB	200ug	59670
CLSDF9746	PITPNA Antibody	50ug/50ul ,100ug/100ul	Human, Mouse, Rat	WB	200ug	59670
CLSDF9747	INPPL1 Antibody	50ug/50ul ,100ug/100ul	Human, Mouse, Rat	WB	200ug	59670
CLSDF9748	PIGF Antibody	50ug/50ul ,100ug/100ul	Human, Mouse	WB	200ug	59670
CLSDF9749	PIGW Antibody	50ug/50ul ,100ug/100ul	Human	WB	200ug	59670
CLSDF9750	GPLD1 Antibody	50ug/50ul ,100ug/100ul	Human	WB IHC	200ug	59670
CLSDF9751	PIK3R6 Antibody	50ug/50ul ,100ug/100ul	Human	WB	200ug	59670
CLSDF9752	PLD2 Antibody	50ug/50ul ,100ug/100ul	Human, Mouse, Rat	WB	200ug	59670
CLSDF9753	PLD3 Antibody	50ug/50ul ,100ug/100ul	Human, Mouse, Rat	WB	200ug	59670
CLSDF9754	PLSCR1 Antibody	50ug/50ul ,100ug/100ul	Human	WB	200ug	59670
CLSDF9755	PLSCR2 Antibody	50ug/50ul ,100ug/100ul	Human	WB	200ug	59670
CLSDF9756	PLSCR4 Antibody	50ug/50ul ,100ug/100ul	Human	WB	200ug	59670
CLSDF9757	ATP2B2 Antibody	50ug/50ul ,100ug/100ul	Human, Rat	WB	200ug	59670
CLSDF9758	ATP2B1/2/3 Antibody	50ug/50ul ,100ug/100ul	Human, Mouse, Rat	WB	200ug	59670

Antibodies
HSN : 38220090

Cat#	Product Description	MW	Reactivity	Application	Pack Size	Unit Price
CLSDF9759	GP1BB Antibody	50ug/50ul ,100ug/100ul	Human, Mouse	WB IHC	200ug	59670
CLSDF9760	PLXNA2 Antibody	50ug/50ul ,100ug/100ul	Human, Mouse, Rat	WB IHC	200ug	59670
CLSDF9761	PABPC3 Antibody	50ug/50ul ,100ug/100ul	Human	WB IHC	200ug	59670
CLSDF9762	PABPC4 Antibody	50ug/50ul ,100ug/100ul	Human, Mouse, Rat	WB	200ug	59670
CLSDF9763	KCNE1L Antibody	50ug/50ul ,100ug/100ul	Human, Mouse, Rat	WB	200ug	59670
CLSDF9764	KCNE3 Antibody	50ug/50ul ,100ug/100ul	Human, Mouse, Rat	WB IHC	200ug	59670
CLSDF9765	KCNG4 Antibody	50ug/50ul ,100ug/100ul	Human, Mouse, Rat	WB IHC	200ug	59670
CLSDF9766	KCNH6 Antibody	50ug/50ul ,100ug/100ul	Human, Mouse, Rat	WB	200ug	59670
CLSDF9767	KCNH7 Antibody	50ug/50ul ,100ug/100ul	Human, Mouse, Rat	WB	200ug	59670
CLSDF9768	KCNS1 Antibody	50ug/50ul ,100ug/100ul	Human, Mouse, Rat	WB	200ug	59670
CLSDF9769	KCNS3 Antibody	50ug/50ul ,100ug/100ul	Human, Mouse	WB	200ug	59670
CLSDF9770	HCN3 Antibody	50ug/50ul ,100ug/100ul	Human, Mouse, Rat	WB	200ug	59670
CLSDF9771	HCN4 Antibody	50ug/50ul ,100ug/100ul	Human, Mouse, Rat	WB	200ug	59670
CLSDF9772	PRDM10 Antibody	50ug/50ul ,100ug/100ul	Human, Mouse	WB IHC	200ug	59670
CLSDF9773	PBX4 Antibody	50ug/50ul ,100ug/100ul	Human	WB	200ug	59670
CLSDF9774	CLP1 Antibody	50ug/50ul ,100ug/100ul	Human, Mouse, Rat	WB	200ug	59670
CLSDF9775	PRPF38B Antibody	50ug/50ul ,100ug/100ul	Human, Mouse, Rat	WB	200ug	59670
CLSDF9776	APOBEC3A/B Antibody	50ug/50ul ,100ug/100ul	Human	WB	200ug	59670
CLSDF9777	PART1 Antibody	50ug/50ul ,100ug/100ul	Human	WB	200ug	59670
CLSDF9778	PPP1R14B Antibody	50ug/50ul ,100ug/100ul	Human, Mouse, Rat	WB	200ug	59670
CLSDF9779	PPP1R1C Antibody	50ug/50ul ,100ug/100ul	Human, Mouse	WB	200ug	59670
CLSDF9780	PPP1R3D Antibody	50ug/50ul ,100ug/100ul	Human, Mouse, Rat	WB	200ug	59670
CLSDF9781	PPM1E Antibody	50ug/50ul ,100ug/100ul	Human, Mouse, Rat	WB IHC	200ug	59670
CLSDF9782	PPP1R2P3 Antibody	50ug/50ul ,100ug/100ul	Human	WB IHC	200ug	59670
CLSDF9783	S100A7 Antibody	50ug/50ul ,100ug/100ul	Human	WB IHC	200ug	59670
CLSDF9784	S100A7A Antibody	50ug/50ul ,100ug/100ul	Human	WB	200ug	59670
CLSDF9785	S100G Antibody	50ug/50ul ,100ug/100ul	Human, Mouse, Rat	WB	200ug	59670
CLSDF9786	SEC61B Antibody	50ug/50ul ,100ug/100ul	Human, Mouse, Rat	WB	200ug	59670
CLSDF9787	SERPINA10 Antibody	50ug/50ul ,100ug/100ul	Human, Rat	WB	200ug	59670
CLSDF9788	PAGE3 Antibody	50ug/50ul ,100ug/100ul	Human	WB	200ug	59670
CLSDF9789	CD164 Antibody	50ug/50ul ,100ug/100ul	Human, Mouse, Rat	WB IHC	200ug	59670
CLSDF9790	RBM16 Antibody	50ug/50ul ,100ug/100ul	Human, Mouse, Rat	WB	200ug	59670
CLSDF9791	SAA3P Antibody	50ug/50ul ,100ug/100ul	Human	WB	200ug	59670
CLSDF9792	SFRS14 Antibody	50ug/50ul ,100ug/100ul	Human	WB	200ug	59670
CLSDF9793	TIGA1 Antibody	50ug/50ul ,100ug/100ul	Human	WB	200ug	59670
CLSDF9794	PDP1 Antibody	50ug/50ul ,100ug/100ul	Human, Mouse, Rat	WB	200ug	59670
CLSDF9795	RAB11FIP1 Antibody	50ug/50ul ,100ug/100ul	Human, Mouse	WB	200ug	59670
CLSDF9796	RAB11FIP5 Antibody	50ug/50ul ,100ug/100ul	Human, Mouse, Rat	WB	200ug	59670
CLSDF9797	RABL2B Antibody	50ug/50ul ,100ug/100ul	Human, Mouse, Rat	WB	200ug	59670

Antibodies
HSN : 38220090

Cat#	Product Description	MW	Reactivity	Application	Pack Size	Unit Price
CLSDF9798	RABL5 Antibody	50ug/50ul ,100ug/100ul	Human	WB IHC	200ug	59670
CLSDF9799	RFTN2 Antibody	50ug/50ul ,100ug/100ul	Human, Mouse, Rat	WB IHC	200ug	59670
CLSDF9800	RGL1 Antibody	50ug/50ul ,100ug/100ul	Human, Mouse	WB IHC	200ug	59670
CLSDF9801	REPS2 Antibody	50ug/50ul ,100ug/100ul	Human, Mouse	WB	200ug	59670
CLSDF9802	RGPD5 Antibody	50ug/50ul ,100ug/100ul	Human	WB	200ug	59670
CLSDF9803	RASSF3 Antibody	50ug/50ul ,100ug/100ul	Human, Mouse	WB IHC	200ug	59670
CLSDF9804	RASSF8 Antibody	50ug/50ul ,100ug/100ul	Human	WB IHC	200ug	59670
CLSDF9805	RASA4 Antibody	50ug/50ul ,100ug/100ul	Human, Mouse	WB	200ug	59670
CLSDF9806	RAPH1 Antibody	50ug/50ul ,100ug/100ul	Human	WB	200ug	59670
CLSDF9807	RASGEF1A Antibody	50ug/50ul ,100ug/100ul	Human, Mouse, Rat	WB	200ug	59670
CLSDF9808	RASGEF1B Antibody	50ug/50ul ,100ug/100ul	Human, Mouse, Rat	WB	200ug	59670
CLSDF9809	RASGEF1C Antibody	50ug/50ul ,100ug/100ul	Human, Mouse, Rat	WB	200ug	59670
CLSDF9810	RASIP1 Antibody	50ug/50ul ,100ug/100ul	Human	WB	200ug	59670
CLSDF9811	RERG Antibody	50ug/50ul ,100ug/100ul	Human, Mouse	WB IHC	200ug	59670
CLSDF9812	RRAGD Antibody	50ug/50ul ,100ug/100ul	Human, Mouse, Rat	WB	200ug	59670
CLSDF9813	RAB13 Antibody	50ug/50ul ,100ug/100ul	Human, Mouse, Rat	WB	200ug	59670
CLSDF9814	RAB15 Antibody	50ug/50ul ,100ug/100ul	Human, Mouse, Rat	WB	200ug	59670
CLSDF9815	RAB17 Antibody	50ug/50ul ,100ug/100ul	Human, Mouse, Rat	WB	200ug	59670
CLSDF9816	RAB19 Antibody	50ug/50ul ,100ug/100ul	Human, Mouse, Rat	WB	200ug	59670
CLSDF9817	RAB1A Antibody	50ug/50ul ,100ug/100ul	Human, Mouse, Rat	WB	200ug	59670
CLSDF9818	RAB1B Antibody	50ug/50ul ,100ug/100ul	Human, Mouse, Rat	WB	200ug	59670
CLSDF9819	RAB21 Antibody	50ug/50ul ,100ug/100ul	Human, Mouse, Rat	WB	200ug	59670
CLSDF9820	RAB22A Antibody	50ug/50ul ,100ug/100ul	Human, Mouse, Rat	WB IHC	200ug	59670
CLSDF9821	RAB23 Antibody	50ug/50ul ,100ug/100ul	Human	WB IHC	200ug	59670
CLSDF9822	RAB24 Antibody	50ug/50ul ,100ug/100ul	Human, Mouse, Rat	WB IHC	200ug	59670
CLSDF9823	RAB28 Antibody	50ug/50ul ,100ug/100ul	Human, Mouse, Rat	WB	200ug	59670
CLSDF9824	RAB30 Antibody	50ug/50ul ,100ug/100ul	Human, Mouse, Rat	WB	200ug	59670
CLSDF9825	RAB32 Antibody	50ug/50ul ,100ug/100ul	Human, Mouse, Rat	WB IHC	200ug	59670
CLSDF9826	RAB33B Antibody	50ug/50ul ,100ug/100ul	Human, Mouse, Rat	WB IHC	200ug	59670
CLSDF9827	RAB36 Antibody	50ug/50ul ,100ug/100ul	Human, Mouse	WB	200ug	59670
CLSDF9828	RAB39A Antibody	50ug/50ul ,100ug/100ul	Human, Mouse, Rat	WB	200ug	59670
CLSDF9829	RAB39B Antibody	50ug/50ul ,100ug/100ul	Human, Mouse, Rat	WB	200ug	59670
CLSDF9830	RAB40A Antibody	50ug/50ul ,100ug/100ul	Human, Mouse, Rat	WB	200ug	59670
CLSDF9831	RAB40A/L Antibody	50ug/50ul ,100ug/100ul	Human	WB	200ug	59670
CLSDF9832	RAB40C Antibody	50ug/50ul ,100ug/100ul	Human, Mouse, Rat	WB	200ug	59670
CLSDF9833	RAB43 Antibody	50ug/50ul ,100ug/100ul	Human	WB IHC	200ug	59670
CLSDF9834	RAB5B Antibody	50ug/50ul ,100ug/100ul	Human, Mouse, Rat	WB	200ug	59670
CLSDF9835	RAB6B Antibody	50ug/50ul ,100ug/100ul	Human, Mouse, Rat	WB	200ug	59670
CLSDF9836	RAB8A Antibody	50ug/50ul ,100ug/100ul	Human, Mouse, Rat	WB	200ug	59670

Antibodies
HSN : 38220090

Cat#	Product Description	MW	Reactivity	Application	Pack Size	Unit Price
CLSDF9837	RAB8B Antibody	50ug/50ul ,100ug/100ul	Human, Mouse, Rat	WB	200ug	59670
CLSDF9838	RAB9B Antibody	50ug/50ul ,100ug/100ul	Human, Mouse, Rat	WB	200ug	59670
CLSDF9839	RALB Antibody	50ug/50ul ,100ug/100ul	Human, Mouse, Rat	WB	200ug	59670
CLSDF9840	RRAS2 Antibody	50ug/50ul ,100ug/100ul	Human, Mouse, Rat	WB	200ug	59670
CLSDF9841	PTPRB Antibody	50ug/50ul ,100ug/100ul	Human	WB	200ug	59670
CLSDF9842	PTPRK Antibody	50ug/50ul ,100ug/100ul	Human, Mouse	WB IHC	200ug	59670
CLSDF9843	RELN Antibody	50ug/50ul ,100ug/100ul	Human, Rat	WB IHC	200ug	59670
CLSDF9844	RGS17 Antibody	50ug/50ul ,100ug/100ul	Human, Mouse	WB IHC	200ug	59670
CLSDF9845	RGS19 Antibody	50ug/50ul ,100ug/100ul	Human, Mouse, Rat	WB	200ug	59670
CLSDF9846	RGS20 Antibody	50ug/50ul ,100ug/100ul	Human, Mouse	WB	200ug	59670
CLSDF9847	RGS21 Antibody	50ug/50ul ,100ug/100ul	Human, Mouse, Rat	WB IHC	200ug	59670
CLSDF9848	RGS22 Antibody	50ug/50ul ,100ug/100ul	Human, Mouse, Rat	WB IHC	200ug	59670
CLSDF9849	RGS4 Antibody	50ug/50ul ,100ug/100ul	Human, Mouse, Rat	WB	200ug	59670
CLSDF9850	RFPL2 Antibody	50ug/50ul ,100ug/100ul	Human, Mouse, Rat	WB IHC	200ug	59670
CLSDF9851	RFPL4B Antibody	50ug/50ul ,100ug/100ul	Human	WB	200ug	59670
CLSDF9852	ABCA4 Antibody	50ug/50ul ,100ug/100ul	Human, Mouse	WB	200ug	59670
CLSDF9853	RBBP6 Antibody	50ug/50ul ,100ug/100ul	Human, Mouse	WB	200ug	59670
CLSDF9854	RARRES3 Antibody	50ug/50ul ,100ug/100ul	Human	WB	200ug	59670
CLSDF9855	RHG12 Antibody	50ug/50ul ,100ug/100ul	Human, Mouse, Rat	WB	200ug	59670
CLSDF9856	RHG20 Antibody	50ug/50ul ,100ug/100ul	Human	WB IHC	200ug	59670
CLSDF9857	RHG23 Antibody	50ug/50ul ,100ug/100ul	Human	WB	200ug	59670
CLSDF9858	RHG24 Antibody	50ug/50ul ,100ug/100ul	Human, Mouse, Rat	WB	200ug	59670
CLSDF9859	RHG25 Antibody	50ug/50ul ,100ug/100ul	Human, Mouse, Rat	WB	200ug	59670
CLSDF9860	RHG28 Antibody	50ug/50ul ,100ug/100ul	Human, Mouse, Rat	WB	200ug	59670
CLSDF9861	RHG30 Antibody	50ug/50ul ,100ug/100ul	Human, Mouse, Rat	WB	200ug	59670
CLSDF9862	RHG4 Antibody	50ug/50ul ,100ug/100ul	Human, Mouse, Rat	WB	200ug	59670
CLSDF9863	RHG6 Antibody	50ug/50ul ,100ug/100ul	Human, Mouse, Rat	WB	200ug	59670
CLSDF9864	ARHGEF4 Antibody	50ug/50ul ,100ug/100ul	Human, Mouse, Rat	WB	200ug	59670
CLSDF9865	ARHGEF6 Antibody	50ug/50ul ,100ug/100ul	Human, Mouse, Rat	WB IHC	200ug	59670
CLSDF9866	RHOF Antibody	50ug/50ul ,100ug/100ul	Human, Mouse	WB IHC	200ug	59670
CLSDF9867	RND2 Antibody	50ug/50ul ,100ug/100ul	Human, Mouse, Rat	WB IHC	200ug	59670
CLSDF9868	RTKN Antibody	50ug/50ul ,100ug/100ul	Human, Mouse, Rat	WB	200ug	59670
CLSDF9869	RHOXF1 Antibody	50ug/50ul ,100ug/100ul	Human	WB	200ug	59670
CLSDF9870	RPL22/L1 Antibody	50ug/50ul ,100ug/100ul	Human, Mouse, Rat	WB IHC	200ug	59670
CLSDF9871	RPS6KL1 Antibody	50ug/50ul ,100ug/100ul	Human	WB IHC	200ug	59670
CLSDF9872	BMS1 Antibody	50ug/50ul ,100ug/100ul	Human	WB	200ug	59670
CLSDF9873	SERP1 Antibody	50ug/50ul ,100ug/100ul	Human, Mouse, Rat	WB IHC	200ug	59670
CLSDF9874	RPAP1 Antibody	50ug/50ul ,100ug/100ul	Human	WB	200ug	59670
CLSDF9875	RPAP3 Antibody	50ug/50ul ,100ug/100ul	Human, Mouse, Rat	WB	200ug	59670

Antibodies
HSN : 38220090

Cat#	Product Description	MW	Reactivity	Application	Pack Size	Unit Price
CLSDF9876	CROCC Antibody	50ug/50ul ,100ug/100ul	Human	WB	200ug	59670
CLSDF9877	ROBO1 Antibody	50ug/50ul ,100ug/100ul	Human, Mouse, Rat	WB	200ug	59670
CLSDF9878	SCARA3 Antibody	50ug/50ul ,100ug/100ul	Human, Rat	WB	200ug	59670
CLSDF9879	SFRP3 Antibody	50ug/50ul ,100ug/100ul	Human, Mouse, Rat	WB IHC	200ug	59670
CLSDF9880	SEPT11 Antibody	50ug/50ul ,100ug/100ul	Human, Mouse, Rat	WB	200ug	59670
CLSDF9881	SEPT5 Antibody	50ug/50ul ,100ug/100ul	Human, Mouse, Rat	WB	200ug	59670
CLSDF9882	SRR Antibody	50ug/50ul ,100ug/100ul	Human	WB	200ug	59670
CLSDF9883	STK25 Antibody	50ug/50ul ,100ug/100ul	Human, Mouse, Rat	WB	200ug	59670
CLSDF9884	STK31 Antibody	50ug/50ul ,100ug/100ul	Human	WB	200ug	59670
CLSDF9885	STK38L Antibody	50ug/50ul ,100ug/100ul	Human, Mouse, Rat	WB	200ug	59670
CLSDF9886	NEK4 Antibody	50ug/50ul ,100ug/100ul	Human, Mouse, Rat	WB	200ug	59670
CLSDF9887	PIM2 Antibody	50ug/50ul ,100ug/100ul	Human	WB	200ug	59670
CLSDF9888	RIOK1 Antibody	50ug/50ul ,100ug/100ul	Human, Mouse, Rat	WB IHC	200ug	59670
CLSDF9889	SRPK2 Antibody	50ug/50ul ,100ug/100ul	Human, Mouse, Rat	WB IHC	200ug	59670
CLSDF9890	ULK2 Antibody	50ug/50ul ,100ug/100ul	Human, Mouse, Rat	WB IHC	200ug	59670
CLSDF9891	ULK4 Antibody	50ug/50ul ,100ug/100ul	Human, Mouse, Rat	WB	200ug	59670
CLSDF9892	VRK1 Antibody	50ug/50ul ,100ug/100ul	Human, Mouse, Rat	WB	200ug	59670
CLSDF9893	PPP4R1 Antibody	50ug/50ul ,100ug/100ul	Human, Mouse, Rat	WB	200ug	59670
CLSDF9894	SERPINB10 Antibody	50ug/50ul ,100ug/100ul	Human, Mouse, Rat	WB	200ug	59670
CLSDF9895	SERPINB6 Antibody	50ug/50ul ,100ug/100ul	Human, Mouse, Rat	WB	200ug	59670
CLSDF9896	SCML2 Antibody	50ug/50ul ,100ug/100ul	Human	WB IHC	200ug	59670
CLSDF9897	SH2D4A Antibody	50ug/50ul ,100ug/100ul	Human	WB	200ug	59670
CLSDF9898	SH2B3 Antibody	50ug/50ul ,100ug/100ul	Human	WB	200ug	59670
CLSDF9899	NCKIPSD Antibody	50ug/50ul ,100ug/100ul	Human, Mouse	WB	200ug	59670
CLSDF9900	STAC3 Antibody	50ug/50ul ,100ug/100ul	Human, Mouse, Rat	WB	200ug	59670
CLSDF9901	SHANK3 Antibody	50ug/50ul ,100ug/100ul	Human, Mouse, Rat	WB	200ug	59670
CLSDF9902	SH3PXD2A Antibody	50ug/50ul ,100ug/100ul	Human, Mouse	WB	200ug	59670
CLSDF9903	SH3TC2 Antibody	50ug/50ul ,100ug/100ul	Human	WB	200ug	59670
CLSDF9904	SH3BGR2 Antibody	50ug/50ul ,100ug/100ul	Human, Mouse, Rat	WB	200ug	59670
CLSDF9905	SH3BGR3 Antibody	50ug/50ul ,100ug/100ul	Human, Mouse, Rat	WB IHC	200ug	59670
CLSDF9906	SH3BGR1 Antibody	50ug/50ul ,100ug/100ul	Human, Mouse, Rat	WB IHC	200ug	59670
CLSDF9907	SH3GL3 Antibody	50ug/50ul ,100ug/100ul	Human, Mouse, Rat	WB IHC	200ug	59670
CLSDF9908	SHOX Antibody	50ug/50ul ,100ug/100ul	Human	WB	200ug	59670
CLSDF9909	SLIT3 Antibody	50ug/50ul ,100ug/100ul	Human, Mouse, Rat	WB	200ug	59670
CLSDF9910	CCL1 Antibody	50ug/50ul ,100ug/100ul	Human	WB IHC	200ug	59670
CLSDF9911	CCL13 Antibody	50ug/50ul ,100ug/100ul	Human	WB IHC	200ug	59670
CLSDF9912	CCL16 Antibody	50ug/50ul ,100ug/100ul	Human	WB	200ug	59670
CLSDF9913	CCL17 Antibody	50ug/50ul ,100ug/100ul	Human	WB	200ug	59670
CLSDF9914	CCL18 Antibody	50ug/50ul ,100ug/100ul	Human	WB	200ug	59670

Antibodies
HSN : 38220090

Cat#	Product Description	MW	Reactivity	Application	Pack Size	Unit Price
CLSDF9915	CCL26 Antibody	50ug/50ul ,100ug/100ul	Human	WB	200ug	59670
CLSDF9916	CCL27 Antibody	50ug/50ul ,100ug/100ul	Human	WB	200ug	59670
CLSDF9917	CXCL11 Antibody	50ug/50ul ,100ug/100ul	Human	WB IHC	200ug	59670
CLSDF9918	CXCL13 Antibody	50ug/50ul ,100ug/100ul	Human	WB	200ug	59670
CLSDF9919	CXCL5 Antibody	50ug/50ul ,100ug/100ul	Human	WB	200ug	59670
CLSDF9920	CXCL9 Antibody	50ug/50ul ,100ug/100ul	Human	WB	200ug	59670
CLSDF9921	SLC6A12 Antibody	50ug/50ul ,100ug/100ul	Human	WB	200ug	59670
CLSDF9922	SLC6A13 Antibody	50ug/50ul ,100ug/100ul	Human, Mouse, Rat	WB	200ug	59670
CLSDF9923	SLC6A11 Antibody	50ug/50ul ,100ug/100ul	Human, Mouse, Rat	WB	200ug	59670
CLSDF9924	SLC6A14 Antibody	50ug/50ul ,100ug/100ul	Human	WB	200ug	59670
CLSDF9925	SLC6A18 Antibody	50ug/50ul ,100ug/100ul	Human	WB	200ug	59670
CLSDF9926	SLC6A20 Antibody	50ug/50ul ,100ug/100ul	Human, Mouse	WB IHC	200ug	59670
CLSDF9927	SLC4A7 Antibody	50ug/50ul ,100ug/100ul	Human, Mouse, Rat	WB IHC	200ug	59670
CLSDF9928	SCNM1 Antibody	50ug/50ul ,100ug/100ul	Human	WB IHC	200ug	59670
CLSDF9929	SCN11A Antibody	50ug/50ul ,100ug/100ul	Human	WB	200ug	59670
CLSDF9930	SCN1B Antibody	50ug/50ul ,100ug/100ul	Human, Mouse, Rat	WB	200ug	59670
CLSDF9931	SLC10A4 Antibody	50ug/50ul ,100ug/100ul	Human	WB IHC	200ug	59670
CLSDF9932	SLC8A1 Antibody	50ug/50ul ,100ug/100ul	Human, Mouse, Rat	WB IHC	200ug	59670
CLSDF9933	SLC9A1 Antibody	50ug/50ul ,100ug/100ul	Human, Mouse, Rat	WB	200ug	59670
CLSDF9934	SLC9A10 Antibody	50ug/50ul ,100ug/100ul	Human	WB	200ug	59670
CLSDF9935	SLC9A11 Antibody	50ug/50ul ,100ug/100ul	Human, Mouse, Rat	WB	200ug	59670
CLSDF9936	SLC9A2 Antibody	50ug/50ul ,100ug/100ul	Human, Mouse, Rat	WB	200ug	59670
CLSDF9937	SLC9A3 Antibody	50ug/50ul ,100ug/100ul	Human, Mouse, Rat	WB	200ug	59670
CLSDF9938	SLC9A5 Antibody	50ug/50ul ,100ug/100ul	Human, Mouse, Rat	WB	200ug	59670
CLSDF9939	SLC28A1 Antibody	50ug/50ul ,100ug/100ul	Human, Mouse	WB IHC	200ug	59670
CLSDF9940	SLC24A2 Antibody	50ug/50ul ,100ug/100ul	Human, Mouse	WB	200ug	59670
CLSDF9941	FXYD2 Antibody	50ug/50ul ,100ug/100ul	Human	WB	200ug	59670
CLSDF9942	ATP1A3 Antibody	50ug/50ul ,100ug/100ul	Human, Mouse, Rat	WB	200ug	59670
CLSDF9943	SLC2A2 Antibody	50ug/50ul ,100ug/100ul	Human	WB	200ug	59670
CLSDF9944	SPAG5 Antibody	50ug/50ul ,100ug/100ul	Human	WB	200ug	59670
CLSDF9945	SFRS12 Antibody	50ug/50ul ,100ug/100ul	Human, Mouse, Rat	WB	200ug	59670
CLSDF9946	SFRS16 Antibody	50ug/50ul ,100ug/100ul	Human, Mouse, Rat	WB	200ug	59670
CLSDF9947	SFRS18 Antibody	50ug/50ul ,100ug/100ul	Human, Mouse, Rat	WB	200ug	59670
CLSDF9948	SFRS9 Antibody	50ug/50ul ,100ug/100ul	Human, Mouse, Rat	WB IHC	200ug	59670
CLSDF9949	STMN2 Antibody	50ug/50ul ,100ug/100ul	Human, Mouse, Rat	WB IHC	200ug	59670
CLSDF9950	ZNF280B Antibody	50ug/50ul ,100ug/100ul	Human, Mouse	WB IHC	200ug	59670
CLSDF9951	ZNF280D Antibody	50ug/50ul ,100ug/100ul	Human	WB	200ug	59670
CLSDF9952	SV2C Antibody	50ug/50ul ,100ug/100ul	Human, Mouse, Rat	WB	200ug	59670
CLSDF9953	SYT10 Antibody	50ug/50ul ,100ug/100ul	Human, Mouse, Rat	WB	200ug	59670

Antibodies

HSN : 38220090

Cat#	Product Description	MW	Reactivity	Application	Pack Size	Unit Price
CLSDF9954	SYT4 Antibody	50ug/50ul ,100ug/100ul	Human	WB	200ug	59670
CLSDF9955	SYT8 Antibody	50ug/50ul ,100ug/100ul	Human	WB	200ug	59670
CLSDF9956	STX6 Antibody	50ug/50ul ,100ug/100ul	Human, Mouse, Rat	WB IHC	200ug	59670
CLSDF9957	TBC1D2 Antibody	50ug/50ul ,100ug/100ul	Human	WB	200ug	59670
CLSDF9958	TNXB Antibody	50ug/50ul ,100ug/100ul	Human	WB	200ug	59670
CLSDF9959	TIGD2 Antibody	50ug/50ul ,100ug/100ul	Human	WB	200ug	59670
CLSDF9960	TIGD4 Antibody	50ug/50ul ,100ug/100ul	Human, Mouse, Rat	WB	200ug	59670
CLSDF9961	TJP3 Antibody	50ug/50ul ,100ug/100ul	Human, Mouse, Rat	WB	200ug	59670
CLSDF9962	TM2D1 Antibody	50ug/50ul ,100ug/100ul	Human, Mouse, Rat	WB	200ug	59670
CLSDF9963	TRAK2 Antibody	50ug/50ul ,100ug/100ul	Human	WB	200ug	59670
CLSDF9964	TRAPPC1 Antibody	50ug/50ul ,100ug/100ul	Human, Mouse, Rat	WB	200ug	59670
CLSDF9965	TRAPPC5 Antibody	50ug/50ul ,100ug/100ul	Human, Mouse, Rat	WB IHC	200ug	59670
CLSDF9966	ELOF1 Antibody	50ug/50ul ,100ug/100ul	Human, Mouse, Rat	WB IHC	200ug	59670
CLSDF9967	TCEAL2 Antibody	50ug/50ul ,100ug/100ul	Human, Mouse, Rat	WB IHC	200ug	59670
CLSDF9968	TCEAL5 Antibody	50ug/50ul ,100ug/100ul	Human, Mouse, Rat	WB	200ug	59670
CLSDF9969	TCEAL7 Antibody	50ug/50ul ,100ug/100ul	Human, Mouse	WB	200ug	59670
CLSDF9970	TCEAL8 Antibody	50ug/50ul ,100ug/100ul	Human, Mouse, Rat	WB IHC	200ug	59670
CLSDF9971	TCF19 Antibody	50ug/50ul ,100ug/100ul	Human, Mouse, Rat	WB IHC	200ug	59670
CLSDF9972	BTF3L2 Antibody	50ug/50ul ,100ug/100ul	Human	WB	200ug	59670
CLSDF9973	BTF3L3 Antibody	50ug/50ul ,100ug/100ul	Human	WB	200ug	59670
CLSDF9974	BTF3L4 Antibody	50ug/50ul ,100ug/100ul	Human, Mouse	WB	200ug	59670
CLSDF9975	TMC7 Antibody	50ug/50ul ,100ug/100ul	Human, Mouse, Rat	WB	200ug	59670
CLSDF9976	TNNT1 Antibody	50ug/50ul ,100ug/100ul	Human, Mouse, Rat	WB	200ug	59670
CLSDF9977	MPHOSPH10 Antibody	50ug/50ul ,100ug/100ul	Human	WB	200ug	59670
CLSDF9978	SART1 Antibody	50ug/50ul ,100ug/100ul	Human, Mouse, Rat	WB IHC	200ug	59670
CLSDF9979	LSM2 Antibody	50ug/50ul ,100ug/100ul	Human, Mouse, Rat	WB	200ug	59670
CLSDF9980	UBQLN2 Antibody	50ug/50ul ,100ug/100ul	Human, Mouse, Rat	WB	200ug	59670
CLSDF9981	USP12 Antibody	50ug/50ul ,100ug/100ul	Human, Mouse, Rat	WB	200ug	59670
CLSDF9982	USP14 Antibody	50ug/50ul ,100ug/100ul	Human, Mouse, Rat	WB	200ug	59670
CLSDF9983	USP16 Antibody	50ug/50ul ,100ug/100ul	Human, Mouse, Rat	WB	200ug	59670
CLSDF9984	USP17L Antibody	50ug/50ul ,100ug/100ul	Human, Mouse, Rat	WB	200ug	59670
CLSDF9985	USP24 Antibody	50ug/50ul ,100ug/100ul	Human, Mouse	WB	200ug	59670
CLSDF9986	USP26 Antibody	50ug/50ul ,100ug/100ul	Human	WB	200ug	59670
CLSDF9987	USP29 Antibody	50ug/50ul ,100ug/100ul	Human, Mouse, Rat	WB IHC	200ug	59670
CLSDF9988	USP3 Antibody	50ug/50ul ,100ug/100ul	Human, Mouse, Rat	WB IHC	200ug	59670
CLSDF9989	USP31 Antibody	50ug/50ul ,100ug/100ul	Human, Mouse, Rat	WB IHC	200ug	59670
CLSDF9990	USP34 Antibody	50ug/50ul ,100ug/100ul	Human, Mouse	WB	200ug	59670
CLSDF9991	USP35 Antibody	50ug/50ul ,100ug/100ul	Human	WB	200ug	59670
CLSDF9992	USP46 Antibody	50ug/50ul ,100ug/100ul	Human, Mouse, Rat	WB IHC	200ug	59670

Antibodies
HSN : 38220090

Cat#	Product Description	MW	Reactivity	Application	Pack Size	Unit Price
CLSDF9993	USP49 Antibody	50ug/50ul ,100ug/100ul	Human, Mouse, Rat	WB IHC	200ug	59670
CLSDF9994	USP51 Antibody	50ug/50ul ,100ug/100ul	Human, Mouse, Rat	WB	200ug	59670
CLSDF9995	USP6 Antibody	50ug/50ul ,100ug/100ul	Human, Mouse, Rat	WB	200ug	59670
CLSDF9996	UBE4A Antibody	50ug/50ul ,100ug/100ul	Human, Mouse, Rat	WB	200ug	59670
CLSDF9997	UBE4B Antibody	50ug/50ul ,100ug/100ul	Human, Mouse	WB	200ug	59670
CLSDF9998	OTUB1 Antibody	50ug/50ul ,100ug/100ul	Human, Mouse, Rat	WB	200ug	59670
CLSDF9999	UBE2A/B Antibody	50ug/50ul ,100ug/100ul	Human, Mouse, Rat	WB	200ug	59670
CLSDF10000	UBE2E3 Antibody	50ug/50ul ,100ug/100ul	Human, Mouse	WB IHC	200ug	59670
CLSDF10001	UBE2G1 Antibody	50ug/50ul ,100ug/100ul	Human, Mouse, Rat	WB	200ug	59670
CLSDF10002	UBE2U Antibody	50ug/50ul ,100ug/100ul	Human	WB	200ug	59670
CLSDF10003	KIAA0087 Antibody	50ug/50ul ,100ug/100ul	Human	WB	200ug	59670
CLSDF10004	ATP6V1B2 Antibody	50ug/50ul ,100ug/100ul	Human, Mouse, Rat	WB	200ug	59670
CLSDF10005	ATP6V1G3 Antibody	50ug/50ul ,100ug/100ul	Human	WB	200ug	59670
CLSDF10006	ATP6V0A2 Antibody	50ug/50ul ,100ug/100ul	Human	WB	200ug	59670
CLSDF10007	VCAN Antibody	50ug/50ul ,100ug/100ul	Human	WB	200ug	59670
CLSDF10008	GOLT1A Antibody	50ug/50ul ,100ug/100ul	Human, Mouse	WB	200ug	59670
CLSDF10009	SFT2D3 Antibody	50ug/50ul ,100ug/100ul	Human	WB IHC	200ug	59670
CLSDF10010	SEC22B Antibody	50ug/50ul ,100ug/100ul	Human, Mouse, Rat	WB IHC	200ug	59670
CLSDF10011	TMEM37 Antibody	50ug/50ul ,100ug/100ul	Human	WB IHC	200ug	59670
CLSDF10012	CACNA1D Antibody	50ug/50ul ,100ug/100ul	Human, Mouse, Rat	WB	200ug	59670
CLSDF10013	CACNA1E Antibody	50ug/50ul ,100ug/100ul	Human, Mouse, Rat	WB	200ug	59670
CLSDF10014	CACNA1G Antibody	50ug/50ul ,100ug/100ul	Human, Mouse, Rat	WB IHC	200ug	59670
CLSDF10015	ZNHIT1 Antibody	50ug/50ul ,100ug/100ul	Human, Mouse	WB IHC	200ug	59670
CLSDF10016	ZFH4 Antibody	50ug/50ul ,100ug/100ul	Human, Mouse, Rat	WB	200ug	59670
CLSDF10017	ZNF295 Antibody	50ug/50ul ,100ug/100ul	Human, Mouse	WB IHC	200ug	59670
CLSDF10018	ZNF462 Antibody	50ug/50ul ,100ug/100ul	Human, Mouse, Rat	WB	200ug	59670
CLSDF10019	ZNF600 Antibody	50ug/50ul ,100ug/100ul	Human	WB	200ug	59670
CLSDF10020	SLC30A2 Antibody	50ug/50ul ,100ug/100ul	Human	WB	200ug	59670
CLSDF10021	SLC39A10 Antibody	50ug/50ul ,100ug/100ul	Human, Mouse, Rat	WB	200ug	59670
CLSDF10022	ZP2 Antibody	50ug/50ul ,100ug/100ul	Human	WB	200ug	59670
CLSDF10023	CD164L2 Antibody	50ug/50ul ,100ug/100ul	Human	WB IHC	200ug	59670
CLSDF10024	CC50A Antibody	50ug/50ul ,100ug/100ul	Human, Mouse, Rat	WB	200ug	59670
CLSDF10025	CCNI Antibody	50ug/50ul ,100ug/100ul	Human, Mouse	WB	200ug	59670
CLSDF10026	CD2L5 Antibody	50ug/50ul ,100ug/100ul	Human, Mouse	WB	200ug	59670
CLSDF10027	CD2L6 Antibody	50ug/50ul ,100ug/100ul	Human, Mouse	WB	200ug	59670
CLSDF10028	CD2L7 Antibody	50ug/50ul ,100ug/100ul	Human, Rat	WB	200ug	59670
CLSDF10029	MAGA2 Antibody	50ug/50ul ,100ug/100ul	Human	WB	200ug	59670
CLSDF10030	MAGA3 Antibody	50ug/50ul ,100ug/100ul	Human	WB	200ug	59670
CLSDF10031	MAGA6 Antibody	50ug/50ul ,100ug/100ul	Human	WB	200ug	59670

Antibodies
HSN : 38220090

Cat#	Product Description	MW	Reactivity	Application	Pack Size	Unit Price
CLSDF10032	MAGA8 Antibody	50ug/50ul ,100ug/100ul	Human	WB IHC	200ug	59670
CLSDF10033	MAGAB Antibody	50ug/50ul ,100ug/100ul	Human	WB IHC	200ug	59670
CLSDF10034	MAGAC Antibody	50ug/50ul ,100ug/100ul	Human	WB IHC	200ug	59670
CLSDF10035	MAGB2 Antibody	50ug/50ul ,100ug/100ul	Human	WB	200ug	59670
CLSDF10036	MAGB3 Antibody	50ug/50ul ,100ug/100ul	Human	WB	200ug	59670
CLSDF10037	MAGB6 Antibody	50ug/50ul ,100ug/100ul	Human	WB IHC	200ug	59670
CLSDF10038	MAGBA Antibody	50ug/50ul ,100ug/100ul	Human	WB IHC	200ug	59670
CLSDF10039	MAGBI Antibody	50ug/50ul ,100ug/100ul	Human	WB	200ug	59670
CLSDF10040	MAGD2 Antibody	50ug/50ul ,100ug/100ul	Human, Mouse, Rat	WB IHC	200ug	59670
CLSDF10041	MAGE2 Antibody	50ug/50ul ,100ug/100ul	Human	WB	200ug	59670
CLSDF10042	MAGG1 Antibody	50ug/50ul ,100ug/100ul	Human, Mouse, Rat	WB	200ug	59670
CLSDF10043	MAGH1 Antibody	50ug/50ul ,100ug/100ul	Human, Mouse, Rat	WB	200ug	59670
CLSDF10044	KITH_HHV1E Antibody	50ug/50ul ,100ug/100ul	Human	WB	200ug	59670
CLSDF10045	CNBP Antibody	50ug/50ul ,100ug/100ul	Human, Mouse, Rat	WB	200ug	59670
CLSDF10046	HEN2 Antibody	50ug/50ul ,100ug/100ul	Human, Mouse	WB IHC	200ug	59670
CLSDF10047	ATOH8 Antibody	50ug/50ul ,100ug/100ul	Human	WB	200ug	59670
CLSDF10048	AKAP4 Antibody	50ug/50ul ,100ug/100ul	Human	WB	200ug	59670
CLSDF10049	GF11B Antibody	50ug/50ul ,100ug/100ul	Human	WB	200ug	59670
CLSDF10050	DMRTA1 Antibody	50ug/50ul ,100ug/100ul	Human	WB	200ug	59670
CLSDF10051	ZNF25 Antibody	50ug/50ul ,100ug/100ul	Human	WB	200ug	59670
CLSDF10052	TSH3 Antibody	50ug/50ul ,100ug/100ul	Human	WB	200ug	59670
CLSDF10053	LARP2 Antibody	50ug/50ul ,100ug/100ul	Human, Mouse, Rat	WB	200ug	59670
CLSDF10054	UL97 Antibody	50ug/50ul ,100ug/100ul	Human	WB	200ug	59670
CLSDF10055	TRIM68 Antibody	50ug/50ul ,100ug/100ul	Human	WB IHC	200ug	59670
CLSDF10056	TCF2 Antibody	50ug/50ul ,100ug/100ul	Human, Mouse, Rat	WB IHC	200ug	59670
CLSDF10057	ZNF839 Antibody	50ug/50ul ,100ug/100ul	Human	WB IHC	200ug	59670
CLSDF10058	PTRF Antibody	50ug/50ul ,100ug/100ul	Human, Mouse, Rat	WB	200ug	59670
CLSDF10059	CYFIP1 Antibody	50ug/50ul ,100ug/100ul	Human	WB	200ug	59670
CLSDF10060	TRMT11 Antibody	50ug/50ul ,100ug/100ul	Human	WB	200ug	59670
CLSDF10061	ZNF227 Antibody	50ug/50ul ,100ug/100ul	Human	WB IHC	200ug	59670
CLSDF10062	DMRTC2 Antibody	50ug/50ul ,100ug/100ul	Human	WB	200ug	59670
CLSDF10063	YAF2 Antibody	50ug/50ul ,100ug/100ul	Human	WB	200ug	59670
CLSDF10064	ASPM Antibody	50ug/50ul ,100ug/100ul	Human	WB	200ug	59670
CLSDF10065	ZNF786 Antibody	50ug/50ul ,100ug/100ul	Human	WB	200ug	59670
CLSDF10066	C16orf44 Antibody	50ug/50ul ,100ug/100ul	Human	WB	200ug	59670
CLSDF10067	LZTR1 Antibody	50ug/50ul ,100ug/100ul	Human, Mouse	WB	200ug	59670
CLSDF10068	ZNF441 Antibody	50ug/50ul ,100ug/100ul	Human	WB	200ug	59670
CLSDF10069	TUSC4 Antibody	50ug/50ul ,100ug/100ul	Human, Mouse, Rat	WB	200ug	59670
CLSDF10070	TP73 Antibody	50ug/50ul ,100ug/100ul	Human	WB IHC	200ug	59670

Antibodies
HSN : 38220090

Cat#	Product Description	MW	Reactivity	Application	Pack Size	Unit Price
CLSDF10071	MINA Antibody	50ug/50ul ,100ug/100ul	Human	WB IHC	200ug	59670
CLSDF10072	C1098 Antibody	50ug/50ul ,100ug/100ul	Human	WB IHC	200ug	59670
CLSDF10073	DUX5 Antibody	50ug/50ul ,100ug/100ul	Human	WB	200ug	59670
CLSDF10074	CIC Antibody	50ug/50ul ,100ug/100ul	Human, Mouse, Rat	WB	200ug	59670
CLSDF10075	NEB2 Antibody	50ug/50ul ,100ug/100ul	Human, Mouse, Rat	WB IHC	200ug	59670
CLSDF10076	MYCBP Antibody	50ug/50ul ,100ug/100ul	Human, Mouse	WB IHC	200ug	59670
CLSDF10077	TSC-22R Antibody	50ug/50ul ,100ug/100ul	Human	WB	200ug	59670
CLSDF10078	ZNF577 Antibody	50ug/50ul ,100ug/100ul	Human	WB	200ug	59670
CLSDF10079	HIPK3 Antibody	50ug/50ul ,100ug/100ul	Human	WB	200ug	59670
CLSDF10080	POLM Antibody	50ug/50ul ,100ug/100ul	Human	WB	200ug	59670
CLSDF10081	NOLA1 Antibody	50ug/50ul ,100ug/100ul	Human, Mouse, Rat	WB	200ug	59670
CLSDF10082	TF2L1 Antibody	50ug/50ul ,100ug/100ul	Human, Mouse, Rat	WB IHC	200ug	59670
CLSDF10083	VPS54 Antibody	50ug/50ul ,100ug/100ul	Human	WB	200ug	59670
CLSDF10084	RHCG Antibody	50ug/50ul ,100ug/100ul	Human	WB	200ug	59670
CLSDF10085	STAP-2 Antibody	50ug/50ul ,100ug/100ul	Human	WB	200ug	59670
CLSDF10086	RTDR1 Antibody	50ug/50ul ,100ug/100ul	Human	WB	200ug	59670
CLSDF10087	JDP2 Antibody	50ug/50ul ,100ug/100ul	Human, Mouse, Rat	WB	200ug	59670
CLSDF10088	CDYL1 Antibody	50ug/50ul ,100ug/100ul	Human	WB	200ug	59670
CLSDF10089	DUET Antibody	50ug/50ul ,100ug/100ul	Human, Mouse, Rat	WB	200ug	59670
CLSDF10090	CDY1 Antibody	50ug/50ul ,100ug/100ul	Human	WB	200ug	59670
CLSDF10091	Cytochrome P450 11B2 Antibody	50ug/50ul ,100ug/100ul	Human, Mouse, Rat	WB IHC	200ug	59670
CLSDF10092	CCBE1 Antibody	50ug/50ul ,100ug/100ul	Human	WB IHC	200ug	59670
CLSDF10093	COX7B Antibody	50ug/50ul ,100ug/100ul	Human	WB IHC	200ug	59670
CLSDF10094	COX7A2L Antibody	50ug/50ul ,100ug/100ul	Human, Mouse, Rat	WB	200ug	59670
CLSDF10095	COX82 Antibody	50ug/50ul ,100ug/100ul	Human	WB	200ug	59670
CLSDF10096	COX6A2 Antibody	50ug/50ul ,100ug/100ul	Human	WB IHC	200ug	59670
CLSDF10097	COX6B2 Antibody	50ug/50ul ,100ug/100ul	Human	WB IHC	200ug	59670
CLSDF10098	COX7A1 Antibody	50ug/50ul ,100ug/100ul	Human	WB	200ug	59670
CLSDF10099	CYBA Antibody	50ug/50ul ,100ug/100ul	Human	WB	200ug	59670
CLSDF10100	DEDD Antibody	50ug/50ul ,100ug/100ul	Human, Mouse, Rat	WB	200ug	59670
CLSDF10101	DNAJB2 Antibody	50ug/50ul ,100ug/100ul	Human	WB	200ug	59670
CLSDF10102	EMID2 Antibody	50ug/50ul ,100ug/100ul	Human, Mouse	WB	200ug	59670
CLSDF10103	FBF1 Antibody	50ug/50ul ,100ug/100ul	Human, Mouse	WB	200ug	59670
CLSDF10104	GRIK5 Antibody	50ug/50ul ,100ug/100ul	Human	WB IHC	200ug	59670
CLSDF10105	GRIP2 Antibody	50ug/50ul ,100ug/100ul	Human	WB	200ug	59670
CLSDF10106	IL20L2 Antibody	50ug/50ul ,100ug/100ul	Human	WB	200ug	59670
CLSDF10107	IL22RA2 Antibody	50ug/50ul ,100ug/100ul	Human	WB	200ug	59670
CLSDF10108	IL28RA Antibody	50ug/50ul ,100ug/100ul	Human	WB	200ug	59670
CLSDF10109	IFNW1 Antibody	50ug/50ul ,100ug/100ul	Human	WB	200ug	59670

Antibodies
HSN : 38220090

Cat#	Product Description	MW	Reactivity	Application	Pack Size	Unit Price
CLSDF10110	IGFL2 Antibody	50ug/50ul ,100ug/100ul	Human	WB	200ug	59670
CLSDF10111	IGFL4 Antibody	50ug/50ul ,100ug/100ul	Human	WB	200ug	59670
CLSDF10112	IL1F7 Antibody	50ug/50ul ,100ug/100ul	Human	WB	200ug	59670
CLSDF10113	IL1F9 Antibody	50ug/50ul ,100ug/100ul	Human	WB IHC	200ug	59670
CLSDF10114	IL31R Antibody	50ug/50ul ,100ug/100ul	Human	WB IHC	200ug	59670
CLSDF10115	IFI6 Antibody	50ug/50ul ,100ug/100ul	Human	WB IHC	200ug	59670
CLSDF10116	KRT84 Antibody	50ug/50ul ,100ug/100ul	Human, Mouse, Rat	WB	200ug	59670
CLSDF10117	KRT81/86 Antibody	50ug/50ul ,100ug/100ul	Human	WB	200ug	59670
CLSDF10118	SETMAR Antibody	50ug/50ul ,100ug/100ul	Human	WB	200ug	59670
CLSDF10119	XCL1/2 Antibody	50ug/50ul ,100ug/100ul	Human	WB	200ug	59670
CLSDF10120	CCNB3 Antibody	50ug/50ul ,100ug/100ul	Human	WB	200ug	59670
CLSDF10121	CDC14B/C Antibody	50ug/50ul ,100ug/100ul	Human, Mouse	WB IHC	200ug	59670
CLSDF10122	MCM8 Antibody	50ug/50ul ,100ug/100ul	Human, Rat	WB	200ug	59670
CLSDF10123	STRN Antibody	50ug/50ul ,100ug/100ul	Human, Mouse, Rat	WB	200ug	59670
CLSDF10124	KLF17 Antibody	50ug/50ul ,100ug/100ul	Human	WB	200ug	59670
CLSDF10125	SMARCD1/3 Antibody	50ug/50ul ,100ug/100ul	Human, Mouse	WB	200ug	59670
CLSDF10126	ORC3 Antibody	50ug/50ul ,100ug/100ul	Human	WB	200ug	59670
CLSDF10127	Cytochrome P450 2C9 Antibody	50ug/50ul ,100ug/100ul	Human	WB	200ug	59670
CLSDF10128	Cytochrome P450 4Z1/2 Antibody	50ug/50ul ,100ug/100ul	Human	WB	200ug	59670
CLSDF10129	Cytochrome P450 2A6/7/13 Antibody	50ug/50ul ,100ug/100ul	Human	WB	200ug	59670
CLSDF10130	Truncated steroid 21-hydroxylase Antibody	50ug/50ul ,100ug/100ul	Human	WB IHC	200ug	59670
CLSDF10131	PIK3C2G Antibody	50ug/50ul ,100ug/100ul	Human	WB IHC	200ug	59670
CLSDF10132	NPR1 Antibody	50ug/50ul ,100ug/100ul	Human, Mouse, Rat	WB IHC	200ug	59670
CLSDF10133	NPR2 Antibody	50ug/50ul ,100ug/100ul	Human, Mouse, Rat	WB	200ug	59670
CLSDF10134	CAMKK1 Antibody	50ug/50ul ,100ug/100ul	Human, Mouse, Rat	WB	200ug	59670
CLSDF10135	CSNK1G3 Antibody	50ug/50ul ,100ug/100ul	Human, Mouse, Rat	WB IHC	200ug	59670
CLSDF10136	DYRK2 Antibody	50ug/50ul ,100ug/100ul	Human, Mouse	WB IHC	200ug	59670
CLSDF10137	NEK3 Antibody	50ug/50ul ,100ug/100ul	Human, Mouse, Rat	WB	200ug	59670
CLSDF10138	PAK6 Antibody	50ug/50ul ,100ug/100ul	Human, Mouse, Rat	WB	200ug	59670
CLSDF10139	PCK2 Antibody	50ug/50ul ,100ug/100ul	Human, Mouse, Rat	WB	200ug	59670
CLSDF10140	SNF1LK2 Antibody	50ug/50ul ,100ug/100ul	Human, Mouse, Rat	WB	200ug	59670
CLSDF10141	RIPK3 Antibody	50ug/50ul ,100ug/100ul	Human	WB	200ug	59670
CLSDF10142	TSSK6 Antibody	50ug/50ul ,100ug/100ul	Human, Mouse, Rat	WB	200ug	59670
CLSDF10143	KALRN Antibody	50ug/50ul ,100ug/100ul	Human, Mouse, Rat	WB IHC	200ug	59670
CLSDF10144	TSSK1 Antibody	50ug/50ul ,100ug/100ul	Human, Mouse, Rat	WB	200ug	59670
CLSDF10145	TXK Antibody	50ug/50ul ,100ug/100ul	Human	WB	200ug	59670
CLSDF10146	NRBP1 Antibody	50ug/50ul ,100ug/100ul	Human, Mouse, Rat	WB	200ug	59670
CLSDF10147	APOB48R Antibody	50ug/50ul ,100ug/100ul	Human	WB	200ug	59670
CLSDF10148	APOC1 Antibody	50ug/50ul ,100ug/100ul	Human	WB	200ug	59670

Antibodies
HSN : 38220090

Cat#	Product Description	MW	Reactivity	Application	Pack Size	Unit Price
CLSDF10149	Tubulin β Antibody	50ug/50ul ,100ug/100ul	Human, Mouse, Rat	WB	200ug	59670
CLSDF10150	CD1B Antibody	50ug/50ul ,100ug/100ul	Human	WB	200ug	59670
CLSDF10151	CEACAM8 Antibody	50ug/50ul ,100ug/100ul	Human	WB	200ug	59670
CLSDF10152	LILRB5 Antibody	50ug/50ul ,100ug/100ul	Human	WB IHC	200ug	59670
CLSDF10153	ADAM8 Antibody	50ug/50ul ,100ug/100ul	Human	WB IHC	200ug	59670
CLSDF10154	KLRC2/4 Antibody	50ug/50ul ,100ug/100ul	Human	WB IHC	200ug	59670
CLSDF10155	CD200 Antibody	50ug/50ul ,100ug/100ul	Human	WB	200ug	59670
CLSDF10156	TNFRSF13C Antibody	50ug/50ul ,100ug/100ul	Human	WB	200ug	59670
CLSDF10157	CD300LB Antibody	50ug/50ul ,100ug/100ul	Human	WB IHC	200ug	59670
CLSDF10158	GABARAPL2 Antibody	50ug/50ul ,100ug/100ul	Human, Mouse, Rat	WB IHC	200ug	59670
CLSDF10159	IL28A Antibody	50ug/50ul ,100ug/100ul	Human	WB	200ug	59670
CLSDF10160	IL27RA Antibody	50ug/50ul ,100ug/100ul	Human	WB	200ug	59670
CLSDF10161	PSD4 Antibody	50ug/50ul ,100ug/100ul	Human	WB	200ug	59670
CLSDF10162	RGMB Antibody	50ug/50ul ,100ug/100ul	Human	WB	200ug	59670
CLSDF10163	ECM1 Antibody	50ug/50ul ,100ug/100ul	Human	WB	200ug	59670
CLSDF10164	HBQ1 Antibody	50ug/50ul ,100ug/100ul	Human	WB	200ug	59670
CLSDF10165	COLEC12 Antibody	50ug/50ul ,100ug/100ul	Human, Mouse, Rat	WB IHC	200ug	59670
CLSDF10166	SOST Antibody	50ug/50ul ,100ug/100ul	Human	WB	200ug	59670
CLSDF10167	CXCL17 Antibody	50ug/50ul ,100ug/100ul	Human	WB	200ug	59670
CLSDF10168	PODN Antibody	50ug/50ul ,100ug/100ul	Human	WB	200ug	59670
CLSDF10169	OPTC Antibody	50ug/50ul ,100ug/100ul	Human	WB	200ug	59670
CLSDF10170	GYPA Antibody	50ug/50ul ,100ug/100ul	Human	WB IHC	200ug	59670
CLSDF10171	PODXL2 Antibody	50ug/50ul ,100ug/100ul	Human	WB	200ug	59670
CLSDF10172	SFRP1 Antibody	50ug/50ul ,100ug/100ul	Human, Mouse, Rat	WB	200ug	59670
CLSDF10173	FCRL4 Antibody	50ug/50ul ,100ug/100ul	Human	WB	200ug	59670
CLSDF10174	CDO1 Antibody	50ug/50ul ,100ug/100ul	Human, Mouse, Rat	WB	200ug	59670
CLSDF10175	CDC37L1 Antibody	50ug/50ul ,100ug/100ul	Human, Rat	WB	200ug	59670
CLSDF10176	SEMA6D Antibody	50ug/50ul ,100ug/100ul	Human, Mouse, Rat	WB	200ug	59670
CLSDF10177	RLN3 Antibody	50ug/50ul ,100ug/100ul	Human	WB	200ug	59670
CLSDF10178	LINGO2 Antibody	50ug/50ul ,100ug/100ul	Human, Mouse	WB	200ug	59670
CLSDF10179	PSG3 Antibody	50ug/50ul ,100ug/100ul	Human	WB IHC	200ug	59670
CLSDF10180	RLN2 Antibody	50ug/50ul ,100ug/100ul	Human	WB IHC	200ug	59670
CLSDF10181	DNER Antibody	50ug/50ul ,100ug/100ul	Human, Mouse, Rat	WB IHC	200ug	59670
CLSDF10182	CLEC6A Antibody	50ug/50ul ,100ug/100ul	Human	WB	200ug	59670
CLSDF10183	REG4 Antibody	50ug/50ul ,100ug/100ul	Human	WB	200ug	59670
CLSDF10184	MFGE8 Antibody	50ug/50ul ,100ug/100ul	Human	WB IHC	200ug	59670
CLSDF10185	PLUNC Antibody	50ug/50ul ,100ug/100ul	Human	WB IHC	200ug	59670
CLSDF10186	TRPV3 Antibody	50ug/50ul ,100ug/100ul	Human, Mouse	WB	200ug	59670
CLSDF10187	FDCSP Antibody	50ug/50ul ,100ug/100ul	Human	WB	200ug	59670

Antibodies
HSN : 38220090

Cat#	Product Description	MW	Reactivity	Application	Pack Size	Unit Price
CLSDF10188	GH1 Antibody	50ug/50ul ,100ug/100ul	Human	WB	200ug	59670
CLSDF10189	TXN2 Antibody	50ug/50ul ,100ug/100ul	Human, Mouse, Rat	WB	200ug	59670
CLSDF10190	ENOSF1 Antibody	50ug/50ul ,100ug/100ul	Human	WB	200ug	59670
CLSDF10191	LTBP1 Antibody	50ug/50ul ,100ug/100ul	Human, Mouse, Rat	WB IHC	200ug	59670
CLSDF10192	SCGN Antibody	50ug/50ul ,100ug/100ul	Human, Mouse, Rat	WB	200ug	59670
CLSDF10193	TNFRSF17 Antibody	50ug/50ul ,100ug/100ul	Human	WB	200ug	59670
CLSDF10194	CREG1 Antibody	50ug/50ul ,100ug/100ul	Human	WB	200ug	59670
CLSDF10195	HTR3B Antibody	50ug/50ul ,100ug/100ul	Human	WB	200ug	59670
CLSDF10196	HTR3C Antibody	50ug/50ul ,100ug/100ul	Human	WB	200ug	59670
CLSDF10197	HTR3D Antibody	50ug/50ul ,100ug/100ul	Human, Mouse, Rat	WB	200ug	59670
CLSDF10198	C3AR1 Antibody	50ug/50ul ,100ug/100ul	Human	WB	200ug	59670
CLSDF10199	BDKRB1 Antibody	50ug/50ul ,100ug/100ul	Human	WB	200ug	59670
CLSDF10200	BAI2 Antibody	50ug/50ul ,100ug/100ul	Human, Mouse	WB IHC	200ug	59670
CLSDF10201	BAI3 Antibody	50ug/50ul ,100ug/100ul	Human, Mouse	WB IHC	200ug	59670
CLSDF10202	CALCR Antibody	50ug/50ul ,100ug/100ul	Human	WB IHC	200ug	59670
CLSDF10203	CALCRL Antibody	50ug/50ul ,100ug/100ul	Human, Mouse, Rat	WB	200ug	59670
CLSDF10204	CCR10 Antibody	50ug/50ul ,100ug/100ul	Human, Mouse	WB	200ug	59670
CLSDF10205	CCR3 Antibody	50ug/50ul ,100ug/100ul	Human, Mouse, Rat	WB IHC	200ug	59670
CLSDF10206	CCR4 Antibody	50ug/50ul ,100ug/100ul	Human, Mouse	WB IHC	200ug	59670
CLSDF10207	CCR6 Antibody	50ug/50ul ,100ug/100ul	Human, Mouse	WB	200ug	59670
CLSDF10208	CCR8 Antibody	50ug/50ul ,100ug/100ul	Human, Mouse	WB	200ug	59670
CLSDF10209	CELSR1 Antibody	50ug/50ul ,100ug/100ul	Human	WB	200ug	59670
CLSDF10210	C5AR1 Antibody	50ug/50ul ,100ug/100ul	Human	WB	200ug	59670
CLSDF10211	DRD2 Antibody	50ug/50ul ,100ug/100ul	Human, Rat	WB	200ug	59670
CLSDF10212	DRD3 Antibody	50ug/50ul ,100ug/100ul	Human, Mouse, Rat	WB	200ug	59670
CLSDF10213	PE2R1 Antibody	50ug/50ul ,100ug/100ul	Human	WB IHC	200ug	59670
CLSDF10214	Seven Transmembrane Helix Receptor Antibody	50ug/50ul ,100ug/100ul	Human	WB	200ug	59670
CLSDF10215	GPR182 Antibody	50ug/50ul ,100ug/100ul	Human	WB	200ug	59670
CLSDF10216	GLP2R Antibody	50ug/50ul ,100ug/100ul	Human, Rat	WB	200ug	59670
CLSDF10217	GPR112 Antibody	50ug/50ul ,100ug/100ul	Human	WB	200ug	59670
CLSDF10218	GPR125 Antibody	50ug/50ul ,100ug/100ul	Human	WB	200ug	59670
CLSDF10219	GPR179 Antibody	50ug/50ul ,100ug/100ul	Human	WB	200ug	59670
CLSDF10220	GPR85 Antibody	50ug/50ul ,100ug/100ul	Human, Mouse, Rat	WB	200ug	59670
CLSDF10221	GPR98 Antibody	50ug/50ul ,100ug/100ul	Human, Mouse	WB	200ug	59670
CLSDF10222	GRM2 Antibody	50ug/50ul ,100ug/100ul	Human, Mouse, Rat	WB IHC	200ug	59670
CLSDF10223	LT4R1 Antibody	50ug/50ul ,100ug/100ul	Human, Mouse, Rat	WB IHC	200ug	59670
CLSDF10224	OR10H5 Antibody	50ug/50ul ,100ug/100ul	Human	WB IHC	200ug	59670
CLSDF10225	OR13J1 Antibody	50ug/50ul ,100ug/100ul	Human	WB	200ug	59670
CLSDF10226	OR4C46 Antibody	50ug/50ul ,100ug/100ul	Human	WB	200ug	59670

Antibodies
HSN : 38220090

Cat#	Product Description	MW	Reactivity	Application	Pack Size	Unit Price
CLSDF10227	OR4F15 Antibody	50ug/50ul ,100ug/100ul	Human	WB	200ug	59670
CLSDF10228	OR52B6 Antibody	50ug/50ul ,100ug/100ul	Human	WB	200ug	59670
CLSDF10229	OR52E6/52E8 Antibody	50ug/50ul ,100ug/100ul	Human	WB	200ug	59670
CLSDF10230	OR52J3 Antibody	50ug/50ul ,100ug/100ul	Human	WB IHC	200ug	59670
CLSDF10231	OR56B2 Antibody	50ug/50ul ,100ug/100ul	Human	WB	200ug	59670
CLSDF10232	OR5AT1 Antibody	50ug/50ul ,100ug/100ul	Human	WB	200ug	59670
CLSDF10233	OR5AV1 Antibody	50ug/50ul ,100ug/100ul	Human	WB	200ug	59670
CLSDF10234	OPSB Antibody	50ug/50ul ,100ug/100ul	Human	WB	200ug	59670
CLSDF10235	OR10P1 Antibody	50ug/50ul ,100ug/100ul	Human	WB	200ug	59670
CLSDF10236	OR10W1 Antibody	50ug/50ul ,100ug/100ul	Human	WB	200ug	59670
CLSDF10237	OR12D2 Antibody	50ug/50ul ,100ug/100ul	Human	WB	200ug	59670
CLSDF10238	OR1A2 Antibody	50ug/50ul ,100ug/100ul	Human	WB	200ug	59670
CLSDF10239	OR1E1 Antibody	50ug/50ul ,100ug/100ul	Human	WB IHC	200ug	59670
CLSDF10240	OR1E2 Antibody	50ug/50ul ,100ug/100ul	Human	WB IHC	200ug	59670
CLSDF10241	OR1K1 Antibody	50ug/50ul ,100ug/100ul	Human	WB IHC	200ug	59670
CLSDF10242	OR1L8 Antibody	50ug/50ul ,100ug/100ul	Human	WB	200ug	59670
CLSDF10243	OR1M1 Antibody	50ug/50ul ,100ug/100ul	Human	WB	200ug	59670
CLSDF10244	OR2B3 Antibody	50ug/50ul ,100ug/100ul	Human	WB IHC	200ug	59670
CLSDF10245	OR2B6 Antibody	50ug/50ul ,100ug/100ul	Human	WB IHC	200ug	59670
CLSDF10246	OR2G6 Antibody	50ug/50ul ,100ug/100ul	Human	WB	200ug	59670
CLSDF10247	OR2L13 Antibody	50ug/50ul ,100ug/100ul	Human	WB	200ug	59670
CLSDF10248	OR2T4 Antibody	50ug/50ul ,100ug/100ul	Human	WB	200ug	59670
CLSDF10249	OR3A4 Antibody	50ug/50ul ,100ug/100ul	Human	WB	200ug	59670
CLSDF10250	OR Antibody	50ug/50ul ,100ug/100ul	Human, Mouse, Rat	WB	200ug	59670
CLSDF10251	OR4D2 Antibody	50ug/50ul ,100ug/100ul	Human, Mouse, Rat	WB	200ug	59670
CLSDF10252	OR4D5 Antibody	50ug/50ul ,100ug/100ul	Human, Mouse, Rat	WB IHC	200ug	59670
CLSDF10253	OR4D9 Antibody	50ug/50ul ,100ug/100ul	Human, Mouse, Rat	WB	200ug	59670
CLSDF10254	OR5L1/2 Antibody	50ug/50ul ,100ug/100ul	Human, Mouse, Rat	WB	200ug	59670
CLSDF10255	OR5T1 Antibody	50ug/50ul ,100ug/100ul	Human	WB	200ug	59670
CLSDF10256	OR5T3 Antibody	50ug/50ul ,100ug/100ul	Human	WB	200ug	59670
CLSDF10257	OR6B1 Antibody	50ug/50ul ,100ug/100ul	Human	WB	200ug	59670
CLSDF10258	P2RY1 Antibody	50ug/50ul ,100ug/100ul	Human, Mouse, Rat	WB	200ug	59670
CLSDF10259	P2RY2 Antibody	50ug/50ul ,100ug/100ul	Human, Mouse, Rat	WB	200ug	59670
CLSDF10260	P2RY5 Antibody	50ug/50ul ,100ug/100ul	Human, Mouse, Rat	WB	200ug	59670
CLSDF10261	P2RY9 Antibody	50ug/50ul ,100ug/100ul	Human, Mouse, Rat	WB IHC	200ug	59670
CLSDF10262	P2RY10 Antibody	50ug/50ul ,100ug/100ul	Human, Mouse, Rat	WB IHC	200ug	59670
CLSDF10263	P2RY12 Antibody	50ug/50ul ,100ug/100ul	Human, Mouse, Rat	WB IHC	200ug	59670
CLSDF10264	PKR2 Antibody	50ug/50ul ,100ug/100ul	Human, Mouse, Rat	WB	200ug	59670
CLSDF10265	RXFP1 Antibody	50ug/50ul ,100ug/100ul	Human, Mouse, Rat	WB	200ug	59670

Antibodies
HSN : 38220090

Cat#	Product Description	MW	Reactivity	Application	Pack Size	Unit Price
CLSDF10266	TAS2R12 Antibody	50ug/50ul ,100ug/100ul	Human, Mouse, Rat	WB IHC	200ug	59670
CLSDF10267	TAS2R38 Antibody	50ug/50ul ,100ug/100ul	Human, Mouse, Rat	WB IHC	200ug	59670
CLSDF10268	TAS2R40 Antibody	50ug/50ul ,100ug/100ul	Human, Mouse, Rat	WB	200ug	59670
CLSDF10269	TAS2R50 Antibody	50ug/50ul ,100ug/100ul	Human, Mouse, Rat	WB	200ug	59670
CLSDF10270	TAS2R60 Antibody	50ug/50ul ,100ug/100ul	Human	WB	200ug	59670
CLSDF10271	TAS2R Antibody	50ug/50ul ,100ug/100ul	Human, Mouse, Rat	WB	200ug	59670
CLSDF10272	TAS2R4 Antibody	50ug/50ul ,100ug/100ul	Human, Mouse, Rat	WB	200ug	59670
CLSDF10273	TAS2R9 Antibody	50ug/50ul ,100ug/100ul	Human, Mouse, Rat	WB	200ug	59670
CLSDF10274	TAAR1 Antibody	50ug/50ul ,100ug/100ul	Human, Mouse, Rat	WB IHC	200ug	59670
CLSDF10275	TAAR2 Antibody	50ug/50ul ,100ug/100ul	Human, Mouse, Rat	WB	200ug	59670
CLSDF10276	TAAR6 Antibody	50ug/50ul ,100ug/100ul	Human, Mouse, Rat	WB	200ug	59670
CLSDF10277	TAAR9 Antibody	50ug/50ul ,100ug/100ul	Human, Mouse, Rat	WB	200ug	59670
CLSDF10278	TAS1R1 Antibody	50ug/50ul ,100ug/100ul	Human, Mouse, Rat	WB	200ug	59670
CLSDF10279	TAS1R2 Antibody	50ug/50ul ,100ug/100ul	Human, Mouse, Rat	WB	200ug	59670
CLSDF10280	VN1R1 Antibody	50ug/50ul ,100ug/100ul	Human	WB	200ug	59670
CLSDF10281	GPR109A/B Antibody	50ug/50ul ,100ug/100ul	Human	WB	200ug	59670
CLSDF10282	OR11A1 Antibody	50ug/50ul ,100ug/100ul	Human	WB	200ug	59670
CLSDF10283	OR13C5 Antibody	50ug/50ul ,100ug/100ul	Human	WB IHC	200ug	59670
CLSDF10284	OR52H1 Antibody	50ug/50ul ,100ug/100ul	Human	WB IHC	200ug	59670
CLSDF10285	OR52K2 Antibody	50ug/50ul ,100ug/100ul	Human	WB IHC	200ug	59670
CLSDF10286	OR52L2 Antibody	50ug/50ul ,100ug/100ul	Human	WB	200ug	59670
CLSDF10287	OR52M1 Antibody	50ug/50ul ,100ug/100ul	Human	WB	200ug	59670
CLSDF10288	OR52N2 Antibody	50ug/50ul ,100ug/100ul	Human	WB IHC	200ug	59670
CLSDF10289	OR52N5 Antibody	50ug/50ul ,100ug/100ul	Human	WB IHC	200ug	59670
CLSDF10290	OR52P1 Antibody	50ug/50ul ,100ug/100ul	Human	WB	200ug	59670
CLSDF10291	OR52R1 Antibody	50ug/50ul ,100ug/100ul	Human	WB IHC	200ug	59670
CLSDF10292	OR56A4/5 Antibody	50ug/50ul ,100ug/100ul	Human	WB	200ug	59670
CLSDF10293	OR13A1 Antibody	50ug/50ul ,100ug/100ul	Human	WB	200ug	59670
CLSDF10294	OR1C1 Antibody	50ug/50ul ,100ug/100ul	Human	WB	200ug	59670
CLSDF10295	OR2L2 Antibody	50ug/50ul ,100ug/100ul	Human	WB	200ug	59670
CLSDF10296	OR4A47 Antibody	50ug/50ul ,100ug/100ul	Human	WB	200ug	59670
CLSDF10297	OR4N2 Antibody	50ug/50ul ,100ug/100ul	Human	WB IHC	200ug	59670
CLSDF10298	OR5M1 Antibody	50ug/50ul ,100ug/100ul	Human	WB	200ug	59670
CLSDF10299	OR5R1 Antibody	50ug/50ul ,100ug/100ul	Human	WB	200ug	59670
CLSDF10300	TAS2R41 Antibody	50ug/50ul ,100ug/100ul	Human, Mouse, Rat	WB	200ug	59670
CLSDF10301	TAS2R42 Antibody	50ug/50ul ,100ug/100ul	Human, Mouse, Rat	WB	200ug	59670
CLSDF10302	TAS2R44 Antibody	50ug/50ul ,100ug/100ul	Human, Mouse, Rat	WB	200ug	59670
CLSDF10303	TAS2R46 Antibody	50ug/50ul ,100ug/100ul	Human, Mouse, Rat	WB	200ug	59670
CLSDF10304	TAS2R47 Antibody	50ug/50ul ,100ug/100ul	Human, Mouse, Rat	WB	200ug	59670

Antibodies
HSN : 38220090

Cat#	Product Description	MW	Reactivity	Application	Pack Size	Unit Price
CLSDF10305	U12 Antibody	50ug/50ul ,100ug/100ul	Human, Mouse, Rat	WB	200ug	59670
CLSDF10306	HCG39951 Antibody	50ug/50ul ,100ug/100ul	Human	WB IHC	200ug	59670
CLSDF10307	HCG2040518 Antibody	50ug/50ul ,100ug/100ul	Human	WB IHC	200ug	59670
CLSDF10308	BMAL1 antibody	50ug/50ul ,100ug/100ul	Human, Mouse, Rat	WB IHC	200ug	59670
CLSDF10309	Klotho Antibody	50ug/50ul ,100ug/100ul	Human, Mouse, Rat	WB	200ug	59670
CLSDF10310	CFTR Antibody	50ug/50ul ,100ug/100ul	Human, Mouse, Rat	WB	200ug	59670
CLSAF8002	TYK2 (Phospho-Tyr1054) Antibody	133650	Human , Mouse	WB	200ug	59670
CLSAF8003	BACE (Phospho-Ser498) Antibody	55764	Human, Mouse, Rat	WB	200ug	59670
CLSAF8004	CTIP (Phospho-Ser327) Antibody	101942	Human, Mouse	WB	200ug	59670
CLSAF8005	DNA-PK (Phospho-Thr2609) Antibody	469089	Human	WB	200ug	59670
CLSAF8006	CBL (Phospho-Tyr731) Antibody	99647	Human, Mouse, Rat	WB	200ug	59670
CLSAF8007	CDK4 (Phospho-Thr172) Antibody	33730	Human, Mouse, Rat	WB	200ug	59670
CLSAF8008	IR (Phospho-Tyr999) Antibody	156307	Human, Mouse, Rat	WB	200ug	59670
CLSAF8009	IRAK1 (Phospho-Thr387) Antibody	76537	Human, Mouse, Rat	WB	200ug	59670
CLSAF8010	MLC-2 (Phospho-Thr17+Ser18) Antibody	19794/19779/19827	Human, Mouse, Rat,	WB	200ug	59670
CLSAF8011	NFAT1 (Phospho-Ser326) Antibody	100146	Human, Mouse	WB	200ug	59670
CLSAF8012	NFAT2 (Phospho-Ser294) Antibody	101243	Human, Mouse	WB	200ug	59670
CLSAF8013	NF-κB p105 (Phospho-Ser903) Antibody	105356	Human	WB	200ug	59670
CLSAF8014	NF-κB p105 (Phospho-Ser923) Antibody	105356	Human, Mouse, Rat	WB	200ug	59670
CLSAF8015	PDGFRB (Phospho-Tyr1009) Antibody	123968	Human , Mouse , Rat	WB	200ug	59670
CLSAF8016	PECAM-1 (Phospho-Tyr690) Antibody	82536	Human	WB	200ug	59670
CLSAF8017	PKAα CAT (Phospho-Ser338) Antibody	40590	Human, Mouse, Rat	WB	200ug	59670
CLSAF8018	PLCG2 (Phospho-Tyr759) Antibody	147918	Human, Mouse, Rat	WB	200ug	59670
CLSAF8019	RAD9 (Phospho-Ser272) Antibody	42547	Human	WB	200ug	59670
CLSAF8020	RhoA (Phospho-Ser188) Antibody	21768	Human, Mouse, Rat	WB	200ug	59670
CLSAF8021	VAV1 (Phospho-Tyr160) Antibody	98314	Human, Mouse, Rat	WB	200ug	59670
CLSAF8022	VEGFR2 (Phospho-Tyr996) Antibody	151527	Human, Mouse, Rat,	WB	200ug	59670
CLSAF8023	Chk2 (Phospho-Ser19) Antibody	60915	Human	WB	200ug	59670
CLSAF8024	Chk2 (Phospho-Thr432) Antibody	60915	Human	WB	200ug	59670
CLSAF8025	Doublecortin (Phospho-Ser378) Antibody	44925	Human, Mouse, Rat	WB	200ug	59670
CLSAF8026	HSL (Phospho-Ser660) Antibody	116568/84128	Human, Mouse, Rat	WB	200ug	59670
CLSAF8027	PAK4/5/6 (Phospho-Ser474) Antibody	64072	Human, Mouse, Rat	WB	200ug	59670
CLSAF8028	PKC β (Phospho-Ser660) Antibody	76894	Mouse	WB	200ug	59670
CLSAF8029	TLK1 (Phospho-Ser764) Antibody	86700	Human, Mouse	WB	200ug	59670
CLSAF8030	AMPK β1 (Phospho-Ser181) Antibody	30382	Human, Mouse, Rat	WB	200ug	59670
CLSAF8031	B-Myb (Phospho-Thr494/497) Antibody	78764	Human, Mouse, Rat,	WB	200ug	59670
CLSAF8032	Chk2 (Phospho-Thr26+Ser28) Antibody	60915	Human	WB	200ug	59670
CLSAF8033	Histone H2B (Phospho-Ser14) Antibody	13950	Human Mouse	WB	200ug	59670
CLSAF8034	MAX (Phospho-Ser11) Antibody	18275	Human Mouse Rat	WB	200ug	59670
CLSAF8035	MEK1/2 (Phospho-Ser217+Ser221) Antibody	43439	Human Mouse Rat	WB	200ug	59670
CLSAF8036	RBL2 (Phospho-Ser952) Antibody	128367	Human, Mouse, Rat	WB	200ug	59670
CLSAF8037	C/EBP-α (Phospho-Ser193) Antibody	37430	Mouse, Rat,	WB	200ug	59670
CLSAF8038	CD130/gp130 (Phospho-Ser782) Antibody	103523	Human, Mouse,	WB	200ug	59670
CLSAF8039	CD150 (Phospho-Tyr327) Antibody	37231	Human, Mouse,	WB	200ug	59670
CLSAF8040	CD66/CEACAM1 (Phospho-Ser508) Antibody	57560	Human	WB	200ug	59670
CLSAF8041	c-Fes (Phospho-Tyr713) Antibody	93497	Human	WB	200ug	59670
CLSAF8042	CFTR (Phospho-Ser737) Antibody	168142	Human, Mouse, Rat	WB	200ug	59670
CLSAF8043	c-Jun (Phospho-Ser249) Antibody	35676	Human, Mouse, Rat	WB	200ug	59670
CLSAF8044	Cyclin D1 (Phospho-Ser90) Antibody	33729	Human Mouse Rat	WB	200ug	59670
CLSAF8045	4E-BP1 (Phospho-Thr36) Antibody	12580	Human Mouse Rat	WB	200ug	59670
CLSAF8046	DAPK1 (Phospho-Ser308) Antibody	160286	Human, Mouse,	WB	200ug	59670
CLSAF8047	DNA-PK (Phospho-Ser2612) Antibody	469089	Human	WB	200ug	59670
CLSAF8048	HER2 (Phospho-Thr686) Antibody	137910	Human, Mouse, Rat,	WB	200ug	59670
CLSAF8049	HER2 (Phospho-Tyr1139) Antibody	137910	Human , Mouse , Rat,	WB	200ug	59670
CLSAF8050	HER3 (Phospho-Tyr1328) Antibody	148098	Human , Mouse , Rat,	WB	200ug	59670
CLSAF8051	p27 Kip1 (Phospho-Thr157) Antibody	22073	Human	WB	200ug	59670
CLSAF8052	p27 Kip1 (Phospho-Ser178) Antibody	22073	Human, Mouse	WB	200ug	59670
CLSAF8053	PDGFR α (Phospho-Tyr762) Antibody	122670	Human, Mouse, Rat	WB	200ug	59670
CLSAF8054	PPAR α (Phospho-Ser21) Antibody	52225	Human Mouse Rat	WB	200ug	59670
CLSAF8055	Ret (Phospho-Tyr905) Antibody	124319	Human, Mouse, Rat,	WB	200ug	59670
CLSAF8056	Ret (Phospho-Tyr1096) Antibody	124319	Human , Mouse , Rat,	WB	200ug	59670
CLSAF8057	Retinoblastoma (Phospho-Ser612) Antibody	106159	Human	WB	200ug	59670
CLSAF8058	Smad1 (Phospho-Ser214) Antibody	52260	Human, Mouse, Rat	WB	200ug	59670
CLSAF8059	Smad2 (Phospho-Ser255) Antibody	52306	Human, Mouse, Rat	WB	200ug	59670



Antibodies

HSN : 38220090

Cat#	Product Description	MW	Reactivity	Application	Pack Size	Unit Price
CLSAF8060	Smad2 (Phospho-Ser245) Antibody	52306	Human, Mouse, Rat,	WB	200ug	59670
CLSAF8061	Syndecan4 (Phospho-Ser179) Antibody	21642	Human, Mouse, Rat, ,	WB	200ug	59670
CLSAF8062	Gz-α (Phospho-Ser16) Antibody	40924	Human Mouse Rat	WB	200ug	59670
CLSAF8063	HAND1 (Phospho-Ser98) Antibody	23627	Human Mouse Rat	WB	200ug	59670
CLSAF8064	Hic-5 (Phospho-Tyr60) Antibody	49814	Human Mouse Rat	WB	200ug	59670
CLSAF8065	HMG17 (Phospho-Ser29) Antibody	9393	Human Mouse Rat	WB	200ug	59670
CLSAF8066	HSF1 (Phospho-Ser307) Antibody	57260	Human	WB	200ug	59670
CLSAF8067	Huntingtin (Phospho-Ser421) Antibody	347860	Human, Mouse, Rat	WB	200ug	59670
CLSAF8068	IGF2R (Phospho-Ser2484) Antibody	274308	Human , Mouse , Rat	WB	200ug	59670
CLSAF8069	IL-1Ra/CD121α (Phospho-Tyr496) Antibody	65402	Human, Mouse, Rat	WB	200ug	59670
CLSAF8070	ILK-1 (Phospho-Ser343) Antibody	51419	Human, Mouse, Rat	WB	200ug	59670
CLSAF8071	Integrin α4 (Phospho-Ser1027) Antibody	115333	Human , Mouse	WB	200ug	59670
CLSAF8072	ITK (Phospho-Tyr512) Antibody	71831	Human, Mouse	WB	200ug	59670
CLSAF8073	Kv3.4/KCNC4 (Phospho-Ser15) Antibody	69767	Human Mouse Rat	WB	200ug	59670
CLSAF8074	Kv4.2/KCND2 (Phospho-Ser616) Antibody	70577	Human, Mouse, Rat	WB	200ug	59670
CLSAF8075	MAP4 (Phospho-Ser696) Antibody	121019	Human, Mouse, Rat	WB	200ug	59670
CLSAF8076	MARK1/2/3/4 (Phospho-Thr215) Antibody	89003	Human, Mouse, Rat	WB	200ug	59670
CLSAF8077	MARK2 (Phospho-Thr596) Antibody	87911	Human, Mouse, Rat	WB	200ug	59670
CLSAF8078	MAX (Phospho-Ser2) Antibody	18275	Human	WB	200ug	59670
CLSAF8079	MLK3 (Phospho-Thr277+Ser281) Antibody	92688	Human, Mouse, Rat	WB	200ug	59670
CLSAF8080	TGF β Receptor I (Phospho-Ser165) Antibody	55960	Human, Mouse, Rat	WB	200ug	59670
CLSAF8081	TGF β Receptor III (Phospho-Thr842) Antibody	93428	Human, Mouse, Rat	WB	200ug	59670
CLSAF8082	Catenin-α1 (Phospho-Ser641) Antibody	100071	Human, Mouse, Rat,	WB	200ug	59670
CLSAF8083	Centaurin-β1 (Phospho-Ser554) Antibody	81536	Human	WB	200ug	59670
CLSAF8084	Desmoyokin (Phospho-Ser5782) Antibody	629101	Human , Mouse	WB	200ug	59670
CLSAF8085	E1A-associated Protein p300 (Phospho-Ser1834) Antibody	264144	Human , Mouse , Rat	WB	200ug	59670
CLSAF8086	eNOS (Phospho-Ser1179) Antibody	133289	Human , Mouse , Rat	WB	200ug	59670
CLSAF8087	L-plastin (Phospho-Ser5) Antibody	70289	Human	WB	200ug	59670
CLSAF8088	POU2F1/OCT1 (Phospho-Ser385) Antibody	76472	Human, Mouse, Rat	WB	200ug	59670
CLSAF8089	DNA Ligase 4 (Phospho-Thr650) Antibody	103971	Human	WB	200ug	59670
CLSAF8090	TOP2A (Phospho-Ser1213) Antibody	174385	Human , Mouse	WB	200ug	59670
CLSAF8091	Kinesin-like Protein KIF1C (Phospho-Ser1092) Antibody	122947	Human , Mouse , Rat	WB	200ug	59670
CLSAF8092	PKD2 (Phospho-Ser812) Antibody	96722	Human, Mouse, Rat	WB	200ug	59670
CLSAF8093	Presenilin 2 (Phospho-Ser330) Antibody	50140	Human, Mouse, Rat	WB	200ug	59670
CLSAF8094	RBBP8 (Phospho-Ser664) Antibody	101942	Human, Mouse	WB	200ug	59670
CLSAF8095	VAMP4 (Phospho-Ser30) Antibody	16397	Human Mouse Rat	WB	200ug	59670
CLSAF8096	ASK1 (Phospho-Thr838) Antibody	154537	Human, Mouse	WB	200ug	59670
CLSAF8097	ATF-4 (Phospho-Ser219) Antibody	38590	Human, Mouse, Rat	WB	200ug	59670
CLSAF8098	ATF-4 (Phospho-Ser224) Antibody	38590	Human, Mouse, Rat	WB	200ug	59670
CLSAF8099	ATM (Phospho-Ser367) Antibody	350644	Human, Mouse	WB	200ug	59670
CLSAF8100	ATM (Phospho-Ser183) Antibody	350644	Human	WB	200ug	59670
CLSAF8101	Catenin-β (Phospho-Tyr142) Antibody	85497	Human, Mouse, Rat	WB	200ug	59670
CLSAF8102	Catenin-β (Phospho-Ser675) Antibody	85497	Human, Mouse, Rat	WB	200ug	59670
CLSAF8103	Caspase 8 (Phospho-Tyr448) Antibody	55391	Human	WB	200ug	59670
CLSAF8104	Caveolin 2 (Phospho-Ser23) Antibody	18291	Human Mouse Rat	WB	200ug	59670
CLSAF8105	Caveolin 2 (Phospho-Ser36) Antibody	18291	Human	WB	200ug	59670
CLSAF8106	Caveolin 2 (Phospho-Tyr19) Antibody	18291	Human Mouse Rat	WB	200ug	59670
CLSAF8107	CDC25A (Phospho-Ser82) Antibody	59087	Human Mouse Rat	WB	200ug	59670
CLSAF8108	CHK2 (Phospho-Ser33+Ser35) Antibody	60915	Human	WB	200ug	59670
CLSAF8109	CREB (Phospho-Ser111) Antibody	36688	Human, Mouse, Rat	WB	200ug	59670
CLSAF8110	EGFR (Phospho-Tyr998) Antibody	134277	Human Mouse , Rat	WB	200ug	59670
CLSAF8111	eNOS (Phospho-Ser114) Antibody	133289	Human	WB	200ug	59670
CLSAF8112	eNOS (Phospho-Ser633) Antibody	133289	Human, Mouse, Rat	WB	200ug	59670
CLSAF8113	Estrogen Receptor-α (Phospho-Thr311) Antibody	66216	Human, Mouse, Rat	WB	200ug	59670
CLSAF8114	FAK (Phospho-Tyr577) Antibody	119233	Human, Mouse, Rat	WB	200ug	59670
CLSAF8115	FKHRL1 (Phospho-Ser315) Antibody	71277	Human, Mouse, Rat	WB	200ug	59670
CLSAF8116	FKHRL1 (Phospho-Ser644) Antibody	71277	Human, Mouse, Rat	WB	200ug	59670
CLSAF8117	AFX1 (Phospho-Thr455) Antibody	53684	Human	WB	200ug	59670
CLSAF8118	IGF1R (Phospho-Tyr980) Antibody	154793	Human, Mouse, Rat	WB	200ug	59670
CLSAF8119	LIMK1 (Phospho-Ser323) Antibody	72585	Human, Mouse, Rat	WB	200ug	59670
CLSAF8120	Met (Phospho-Tyr1235) Antibody	155527	Human , Mouse , Rat	WB	200ug	59670
CLSAF8121	Met (Phospho-Ser985) Antibody	155527	Human, Mouse, Rat	WB	200ug	59670
CLSAF8122	p53 (Phospho-Thr55) Antibody	43653	Human	WB	200ug	59670
CLSAF8123	PKD1 (Phospho-Tyr376) Antibody	63152	Human, Mouse, Rat	WB	200ug	59670
CLSAF8124	Retinoblastoma (Phospho-Thr252) Antibody	106159	Human, Mouse, Rat	WB	200ug	59670
CLSAF8125	Retinoblastoma (Phospho-Ser788) Antibody	106159	Human, Mouse, Rat	WB	200ug	59670

Antibodies
HSN : 38220090

Cat#	Product Description	MW	Reactivity	Application	Pack Size	Unit Price
CLSAF8126	Rel (Phospho-Ser492/460) Antibody	68520/65225	Human	WB	200ug	59670
CLSAF8127	STAT2 (Phospho-Tyr631) Antibody	97916	Human, Mouse, Rat	WB	200ug	59670
CLSAF8128	STAT4 (Phospho-Ser721) Antibody	85941	Human, Mouse, Rat	WB	200ug	59670
CLSAF8129	Tau (Phospho-Ser717/400) Antibody	78878	Human, Mouse, Rat	WB	200ug	59670
CLSAF8130	VEGFR1 (Phospho-Tyr1242) Antibody	150769	Human	WB	200ug	59670
CLSAF8131	ABL1/2 (Phospho-Tyr89/Tyr70) Antibody	122873/128343	Human Mouse Rat	WB	200ug	59670
CLSAF8132	A-RAF (Phospho-Ser299) Antibody	67585	Human, Mouse, Rat	WB	200ug	59670
CLSAF8133	BLK (Phospho-Tyr389) Antibody	57706	Human, Mouse, Rat	WB	200ug	59670
CLSAF8134	BRK (Phospho-Tyr342) Antibody	51834	Human	WB	200ug	59670
CLSAF8135	BRSK2 (Phospho-Thr260) Antibody	81633	Human, Mouse	WB	200ug	59670
CLSAF8136	CAMKK1/2 (Phospho-Ser458/495) Antibody	55735/64732	Human Mouse Rat	WB	200ug	59670
CLSAF8137	CDK1/CDC2 (Phospho-Thr161) Antibody	34095	Human, Mouse, Rat	WB	200ug	59670
CLSAF8138	CSK (Phospho-Tyr304) Antibody	50704	Human, Mouse, Rat	WB	200ug	59670
CLSAF8139	DAPK1 (Phospho-Ser736) Antibody	160286	Human, Mouse	WB	200ug	59670
CLSAF8140	DAPK1 (Phospho-Ser289) Antibody	160286	Human, Mouse	WB	200ug	59670
CLSAF8141	DYRK1A/B (Phospho-Tyr321/273) Antibody	85584/69198	Human Mouse Rat	WB	200ug	59670
CLSAF8142	DYRK2/4 (Phospho-Tyr386/268) Antibody	66652/59608	Human Mouse Rat	WB	200ug	59670
CLSAF8143	EPHA8 (Phospho-Tyr838) Antibody	111003	Human, Mouse	WB	200ug	59670
CLSAF8144	EPHA8 (Phospho-Tyr615) Antibody	111003	Human, Mouse	WB	200ug	59670
CLSAF8145	EPHB1/2/3/4 (Phospho-Tyr600/602/614/596) Antibody	109885/117493/110330/108270	Human Mouse Rat	WB	200ug	59670
CLSAF8146	ERK5 (Phospho-Thr218+Tyr220) Antibody	88637	Human Mouse Rat	WB	200ug	59670
CLSAF8147	FER (Phospho-Tyr714) Antibody	94638	Human, Mouse, Rat	WB	200ug	59670
CLSAF8148	FGFR2 (Phospho-Tyr769) Antibody	92025	Human, Mouse	WB	200ug	59670
CLSAF8149	FGFR3 (Phospho-Tyr760) Antibody	87710	Human, Mouse, Rat	WB	200ug	59670
CLSAF8150	FGFR4 (Phospho-Tyr754) Antibody	87954	Human, Mouse, Rat	WB	200ug	59670
CLSAF8151	FGFR (Phospho-Tyr412) Antibody	59479	Human	WB	200ug	59670
CLSAF8152	FLT3 (Phospho-Tyr591) Antibody	112903	Human, Mouse	WB	200ug	59670
CLSAF8153	FLT3 (Phospho-Tyr589) Antibody	112903	Human, Mouse	WB	200ug	59670
CLSAF8154	GCN2 (Phospho-Thr899) Antibody	186838	Human, Mouse	WB	200ug	59670
CLSAF8155	HIPK1/2/3 (Phospho-Tyr352/361/359) Antibody	130843/130966/133743	Human Mouse Rat	WB	200ug	59670
CLSAF8156	IKK-ε (Phospho-Ser172) Antibody	80462	Human, Mouse	WB	200ug	59670
CLSAF8157	JAK2 (Phospho-Tyr119) Antibody	130674	Human, Mouse, Rat	WB	200ug	59670
CLSAF8158	JAK2/3 (Phospho-Tyr966/939) Antibody	130674/125099	Human Mouse Rat	WB	200ug	59670
CLSAF8159	JAK3 (Phospho-Tyr904) Antibody	125099	Human, Mouse, Rat	WB	200ug	59670
CLSAF8160	JAK3 (Phospho-Tyr981) Antibody	125099	Human, Mouse	WB	200ug	59670
CLSAF8161	KIT (Phospho-Tyr568) Antibody	109865	Human, Mouse, Rat	WB	200ug	59670
CLSAF8162	KIT (Phospho-Ser746) Antibody	109865	Human	WB	200ug	59670
CLSAF8163	LATS1/2 (Phospho-Ser909/872) Antibody	126870/120194	Human Mouse Rat	WB	200ug	59670
CLSAF8164	LKB1 (Phospho-Ser334) Antibody	48636	Human, Mouse	WB	200ug	59670
CLSAF8165	MAP2K1/2 (Phospho-Ser212/216) Antibody	43439/44424	Human Mouse Rat	WB	200ug	59670
CLSAF8166	MAP3K2 (Phospho-Ser520) Antibody	69741	Human, Mouse	WB	200ug	59670
CLSAF8167	MAP2K5 (Phospho-Thr315) Antibody	50112	Human, Mouse, Rat	WB	200ug	59670
CLSAF8168	MAP2K5 (Phospho-Ser311) Antibody	50112	Human, Mouse, Rat	WB	200ug	59670
CLSAF8169	MNK1 (Phospho-Thr250) Antibody	51342	Human, Mouse, Rat	WB	200ug	59670
CLSAF8170	MNK2 (Phospho-Thr24) Antibody	51875	Human, Mouse, Rat	WB	200ug	59670
CLSAF8171	MOK (Phospho-Tyr161) Antibody	48014	Human, Mouse, Rat	WB	200ug	59670
CLSAF8172	MSK2 (Phospho-Ser196) Antibody	85606	Human, Mouse	WB	200ug	59670
CLSAF8173	MST3 (Phospho-Thr18) Antibody	49308	Human	WB	200ug	59670
CLSAF8174	NDR1/2 (Phospho-Thr444/442) Antibody	54190/54003	Human Mouse Rat	WB	200ug	59670
CLSAF8175	NuaK1 (Phospho-Ser600) Antibody	74305	Human, Mouse	WB	200ug	59670
CLSAF8176	p38-γ/δ (Phospho-Tyr185/182) Antibody	42090/41940	Human Mouse Rat	WB	200ug	59670
CLSAF8177	p70 S6 Kinase (Phospho-Ser427) Antibody	59140	Human, Mouse, Rat	WB	200ug	59670
CLSAF8178	PAK1 (Phospho-Ser21) Antibody	60647	Human Mouse Rat	WB	200ug	59670
CLSAF8179	PASK (Phospho-Thr1165) Antibody	142929	Human, Mouse, Rat	WB	200ug	59670
CLSAF8180	PDGFRb (Phospho-Tyr579+Tyr581) Antibody	123968	Human Mouse Rat	WB	200ug	59670
CLSAF8181	PDGFRb (Phospho-Tyr857) Antibody	123968	Human, Mouse, Rat	WB	200ug	59670
CLSAF8182	PKCD (Phospho-Ser664) Antibody	77477	Human, Mouse	WB	200ug	59670
CLSAF8183	PKCT (Phospho-Tyr90) Antibody	81865	Human Mouse Rat	WB	200ug	59670
CLSAF8184	PKG2 (Phospho-Ser126) Antibody	87432	Human, Mouse, Rat	WB	200ug	59670
CLSAF8185	QIK/QSK (Phospho-Thr175/163) Antibody	84902/103915/139980	Human Mouse Rat	WB	200ug	59670
CLSAF8186	ROS (Phospho-Tyr2274) Antibody	263915	Human, Mouse, Rat	WB	200ug	59670
CLSAF8187	RSK3 (Phospho-Thr356) Antibody	83239	Human, Mouse	WB	200ug	59670
CLSAF8188	RSK3 (Phospho-Ser360) Antibody	83239	Human, Mouse	WB	200ug	59670
CLSAF8189	SIK (Phospho-Thr182) Antibody	84902	Human Rat	WB	200ug	59670
CLSAF8190	TBK1 (Phospho-Ser172) Antibody	83642	Human, Mouse	WB	200ug	59670
CLSAF8191	TGFBR2 (Phospho-Tyr284) Antibody	64568	Human, Mouse, Rat	WB	200ug	59670
CLSAF8192	TIE1 (Phospho-Tyr1117) Antibody	125090	Human, Mouse, Rat	WB	200ug	59670

Antibodies
HSN : 38220090

Cat#	Product Description	MW	Reactivity	Application	Pack Size	Unit Price
CLSAF8193	TIE2 (Phospho-Ser1119) Antibody	125811	Human, Mouse	WB	200ug	59670
CLSAF8194	TTK (Phospho-Thr676) Antibody	97072	Human, Mouse	WB	200ug	59670
CLSAF8195	ZAK (Phospho-Ser165) Antibody	91181	Human, Mouse	WB	200ug	59670
CLSAF8196	PDGFRa (Phospho-Tyr720) Antibody	122670	Human, Mouse, Rat	WB	200ug	59670
CLSAF8197	FRS2 (Phospho-Tyr196) Antibody	57528	Human, Mouse	WB	200ug	59670
CLSAF8198	BIM (Phospho-Ser59) Antibody	22171	Human Mouse Rat	WB	200ug	59670
CLSAF8199	Androgen Receptor (Phospho-Ser81) Antibody	98989	Human	WB	200ug	59670
CLSAF8200	LAT (Phospho-Tyr161) Antibody	27930	Human	WB	200ug	59670
CLSAF8201	c-Ret (Phospho-Tyr981) Antibody	124319	Human, Mouse, Rat	WB	200ug	59670
CLSAF8202	BRCA1 (Phospho-Ser1387) Antibody	207721	Human	WB	200ug	59670
CLSAF8203	eIF2B-ε (Phospho-Ser540) Antibody	80380	Human	WB	200ug	59670
CLSAF8204	BRCA1 (Phospho-Ser1497) Antibody	207721	Human	WB	200ug	59670
CLSAF8205	Retinoic Acid Receptor αβ (Phospho-Ser96) Antibody	50771	Human Mouse Rat	WB	200ug	59670
CLSAF8206	VE-Cadherin (Phospho-Tyr658) Antibody	87516	Human, Mouse	WB	200ug	59670
CLSAF8207	CD91 (Phospho-Ser4520) Antibody	504575	Human, Mouse	WB	200ug	59670
CLSAF8208	ERK1/2 (Phospho-Thr202+Tyr204/Thr185+Tyr187) Antibody	43136/41390	Human Mouse Rat	WB	200ug	59670
CLSAF8209	TRF2 (Phospho-Thr188) Antibody	55551	Human, Mouse, Rat	WB	200ug	59670
CLSAF8210	FGFR1/2/3/4 (Phospho-Tyr653+Tyr654) Antibody	91868	Human Mouse Rat	WB	200ug	59670
CLSAF8211	eIF2B-ε (Phospho-Ser525) Antibody	80380	Human Rat	WB	200ug	59670
CLSAF8212	GRB2 (Phospho-Tyr614) Antibody	74458	Human, Mouse, Rat	WB	200ug	59670
CLSAF8213	CD45 (Phospho-Tyr1216) Antibody	147254	Human	WB	200ug	59670
CLSAF8214	RXR-α (Phospho-Ser260) Antibody	50811	Human, Mouse, Rat	WB	200ug	59670
CLSAF8215	BCL-10 (Phospho-Ser138) Antibody	26252	Human Rat	WB	200ug	59670
CLSAF8216	DAG1 (Phospho-Tyr892) Antibody	97581	Human, Mouse	WB	200ug	59670
CLSAF8217	BL-CAM (Phospho-Tyr842) Antibody	95348	Human	WB	200ug	59670
CLSAF8218	Androgen Receptor (Phospho-Tyr267) Antibody	98989	Human	WB	200ug	59670
CLSAF8219	Leptin Receptor (Phospho-Tyr986) Antibody	132494	Human	WB	200ug	59670
CLSAF8220	C-RAF (Phospho-Tyr340) Antibody	73052	Human, Mouse, Rat	WB	200ug	59670
CLSAF8221	PDGFRa (Phospho-Tyr1018) Antibody	122670	Human, Mouse, Rat	WB	200ug	59670
CLSAF8222	EPH B1/3/4 (Phospho-Tyr778/792/774) Antibody	109885	Human Mouse Rat	WB	200ug	59670
CLSAF8223	Histone H2A (Phospho-Ser2) Antibody	14091	Human Mouse Rat	WB	200ug	59670
CLSAF8224	Leptin Receptor (Phospho-Tyr1141) Antibody	132494	Human, Mouse	WB	200ug	59670
CLSAF8225	ATM (Phospho-Ser1981) Antibody	350644	Human	WB	200ug	59670
CLSAF8226	FGFR1/2 (Phospho-Tyr730/733) Antibody	91868	Human Mouse Rat	WB	200ug	59670
CLSAF8227	FAK (Phospho-Ser732) Antibody	119233	Human, Mouse, Rat	WB	200ug	59670
CLSAF8228	Connexin 43 (Phospho-Ser279) Antibody	43008	Human, Mouse, Rat	WB	200ug	59670
CLSAF8229	IFNAR1 (Phospho-Ser535) Antibody	63525	Human, Mouse	WB	200ug	59670
CLSAF8230	Connexin 43 (Phospho-Ser282) Antibody	43008	Human, Mouse, Rat	WB	200ug	59670
CLSAF8231	nNOS (Phospho-Ser1417) Antibody	160970	Human, Mouse, Rat	WB	200ug	59670
CLSAF8232	SHC (Phospho-Ser36) Antibody	62822	Human	WB	200ug	59670
CLSAF8233	Vimentin (Phospho-Ser39) Antibody	53652	Human	WB	200ug	59670
CLSAF8234	Androgen Receptor (Phospho-Tyr534) Antibody	98989	Human, Mouse, Rat	WB	200ug	59670
CLSAF8235	Estrogen Receptor-β (Phospho-Ser87) Antibody	59216	Human	WB	200ug	59670
CLSAF8236	53BP1 (Phospho-Ser29) Antibody	213574	Human	WB	200ug	59670
CLSAF8237	Acinus (Phospho-Ser1180) Antibody	151888/125869/92577/59380	Human, Mouse, Rat	WB	200ug	59670
CLSAF8238	AMPKB1 (Phospho-Ser108) Antibody	30382	Human, Mouse, Rat	WB	200ug	59670
CLSAF8239	ANKRD28 (Phospho-Ser1040) Antibody	116543	Human, Mouse	WB	200ug	59670
CLSAF8240	ANXA1 (Phospho-Tyr21) Antibody	38714	Human	WB	200ug	59670
CLSAF8241	APLF (Phospho-Ser116) Antibody	56956	Human, Mouse	WB	200ug	59670
CLSAF8242	Ataxin-3 (Phospho-Ser256) Antibody	43450	Human, Mouse, Rat	WB	200ug	59670
CLSAF8243	BAG3 (Phospho-Tyr457) Antibody	61595	Human, Mouse, Rat	WB	200ug	59670
CLSAF8244	Bcl-6 (Phospho-Ser343) Antibody	78846	Human, Mouse	WB	200ug	59670
CLSAF8245	BCLAF1 (Phospho-Ser531) Antibody	106122	Human, Mouse, Rat	WB	200ug	59670
CLSAF8246	BLK (Phospho-Ser35) Antibody	18016	Human	WB	200ug	59670
CLSAF8247	Bim (Phospho-Thr56/116) Antibody	22171	Human Mouse Rat	WB	200ug	59670
CLSAF8248	Bim (Phospho-Ser44/104) Antibody	22171	Human Mouse Rat	WB	200ug	59670
CLSAF8249	BORA (Phospho-Ser497) Antibody	61203	Human Rat	WB	200ug	59670
CLSAF8250	Caldesmon (Phospho-Ser759) Antibody	93250	Human, Mouse, Rat	WB	200ug	59670
CLSAF8251	Calpain 2 (Phospho-Ser50) Antibody	80009	Human	WB	200ug	59670
CLSAF8252	CdGAP (Phospho-Thr789) Antibody	157015	Human, Mouse, Rat	WB	200ug	59670
CLSAF8253	CDX2 (Phospho-Ser283) Antibody	33510	Human, Mouse, Rat	WB	200ug	59670
CLSAF8254	CEP55 (Phospho-Ser425) Antibody	54124	Human	WB	200ug	59670

Antibodies
HSN : 38220090

Cat#	Product Description	MW	Reactivity	Application	Pack Size	Unit Price
CLSAF8255	Claspin (Phospho-Ser30) Antibody	150368	Human	WB	200ug	59670
CLSAF8256	Claudin 1 (Phospho-Tyr210) Antibody	22744	Human, Mouse, Rat	WB	200ug	59670
CLSAF8257	Claudin 4 (Phospho-Tyr208) Antibody	22077	Human	WB	200ug	59670
CLSAF8258	CRMP-1 (Phospho-Tyr504) Antibody	62184	Human, Mouse, Rat	WB	200ug	59670
CLSAF8259	CIBP1/2 (Phospho-Ser158/164) Antibody	47535/48945	Human	WB	200ug	59670
CLSAF8260	CTNND1 (Phospho-Tyr257) Antibody	108170	Human, Mouse	WB	200ug	59670
CLSAF8261	CTNND1 (Phospho-Tyr904) Antibody	108170	Human, Mouse	WB	200ug	59670
CLSAF8262	CUTL1 (Phospho-Ser1215) Antibody	164273	Human, Mouse, Rat	WB	200ug	59670
CLSAF8263	CUTL1 (Phospho-Ser1237) Antibody	164273	Human, Mouse, Rat	WB	200ug	59670
CLSAF8264	Connexin 43 (Phospho-Ser373) Antibody	43008	Human, Mouse, Rat	WB	200ug	59670
CLSAF8265	Cyclin B1 (Phospho-Ser128) Antibody	48337	Human, Mouse, Rat	WB	200ug	59670
CLSAF8266	Cyclin B1 (Phospho-Ser133) Antibody	48337	Human, Mouse, Rat	WB	200ug	59670
CLSAF8267	Cyclin D1 (Phospho-Thr288) Antibody	33729	Human, Mouse, Rat	WB	200ug	59670
CLSAF8268	DSCR1 (Phospho-Ser108) Antibody	22637	Human, Mouse, Rat	WB	200ug	59670
CLSAF8269	eEF2K (Phospho-Ser359) Antibody	82172	Human, Mouse, Rat	WB	200ug	59670
CLSAF8270	Fos (Phospho-Ser374) Antibody	40695	Human, Mouse, Rat	WB	200ug	59670
CLSAF8271	FKHR (Phospho-Ser249) Antibody	69662	Human, Mouse, Rat	WB	200ug	59670
CLSAF8272	FKHRL1 (Phospho-Ser318) Antibody	71277	Human, Mouse, Rat	WB	200ug	59670
CLSAF8273	FKHRL1 (Phospho-Ser321) Antibody	71277	Human, Mouse, Rat	WB	200ug	59670
CLSAF8274	GAIP (Phospho-Ser151) Antibody	24636	Human, Mouse, Rat	WB	200ug	59670
CLSAF8275	HtrA2 (Phospho-Ser212) Antibody	48841	Human, Mouse, Rat	WB	200ug	59670
CLSAF8276	JDP-2 (Phospho-Thr148) Antibody	18704	Human, Mouse, Rat	WB	200ug	59670
CLSAF8277	Kizuna (Phospho-Thr379) Antibody	75072	Human	WB	200ug	59670
CLSAF8278	LAB (Phospho-Tyr136) Antibody	26550	Human, Mouse, Rat	WB	200ug	59670
CLSAF8279	LIMK1 (Phospho-Ser310) Antibody	72585	Human, Mouse, Rat	WB	200ug	59670
CLSAF8280	MAP2 (Phospho-Thr1616) Antibody	199539	Human, Mouse, Rat	WB	200ug	59670
CLSAF8281	MAP2 (Phospho-Ser136) Antibody	199539	Human, Mouse, Rat	WB	200ug	59670
CLSAF8282	MAZ (Phospho-Thr72) Antibody	48608	Human Mouse Rat	WB	200ug	59670
CLSAF8283	MBP (Phospho-Thr232) Antibody	33117	Human, Mouse, Rat	WB	200ug	59670
CLSAF8284	MCL1 (Phospho-Thr163) Antibody	37337/28662	Human, Mouse, Rat	WB	200ug	59670
CLSAF8285	MKP-1 (Phospho-Ser323) Antibody	39298	Human, Mouse, Rat	WB	200ug	59670
CLSAF8286	MKP-3 (Phospho-Ser197) Antibody	42320	Human, Mouse, Rat	WB	200ug	59670
CLSAF8287	MKP-7 (Phospho-Ser446) Antibody	73102	Human, Mouse	WB	200ug	59670
CLSAF8288	MLK3 (Phospho-Ser674) Antibody	92688	Human, Mouse, Rat	WB	200ug	59670
CLSAF8289	MUC1 (Phospho-Ser1227) Antibody	122072	Human	WB	200ug	59670
CLSAF8290	NACA (Phospho-Ser43) Antibody	23384	Human Mouse Rat	WB	200ug	59670
CLSAF8291	NACA (Phospho-Thr159) Antibody	23384	Human, Mouse, Rat	WB	200ug	59670
CLSAF8292	NDRG2 (Phospho-Thr348) Antibody	40798	Human, Mouse, Rat	WB	200ug	59670
CLSAF8293	NFAT2 (Phospho-Ser172) Antibody	101243	Human, Mouse	WB	200ug	59670
CLSAF8294	p21 Cip1 (Phospho-Ser129) Antibody	18119	Human	WB	200ug	59670
CLSAF8295	p53 (Phospho-Ser392) Antibody	43653	Human	WB	200ug	59670
CLSAF8296	p73 (Phospho-Thr86) Antibody	69623	Human	WB	200ug	59670
CLSAF8297	PAK6 (Phospho-Ser165) Antibody	74869	Human, Mouse	WB	200ug	59670
CLSAF8298	PDE4D (Phospho-Ser578) Antibody	91115	Human, Mouse, Rat	WB	200ug	59670
CLSAF8299	PDE6G (Phospho-Thr22) Antibody	9643	Human Mouse Rat	WB	200ug	59670
CLSAF8300	PDX1 (Phospho-Ser61) Antibody	30771	Human	WB	200ug	59670
CLSAF8301	PDX1 (Phospho-Ser66) Antibody	30771	Human Mouse Rat	WB	200ug	59670
CLSAF8302	PPARBP (Phospho-Thr1032) Antibody	168478	Human, Mouse	WB	200ug	59670
CLSAF8303	Progesterone Receptor (Phospho-Ser345) Antibody	98981/82295	Human	WB	200ug	59670
CLSAF8304	PSEN1 (Phospho-Ser353) Antibody	52668	Human, Mouse, Rat	WB	200ug	59670
CLSAF8305	PTP1B (Phospho-Tyr66) Antibody	49967	Human Mouse Rat	WB	200ug	59670
CLSAF8306	RAD17 (Phospho-Ser646) Antibody	77055	Human, Mouse, Rat	WB	200ug	59670
CLSAF8307	RAD23 (Phospho-Ser357) Antibody	39609	Human, Mouse	WB	200ug	59670
CLSAF8308	RAD50 (Phospho-Ser635) Antibody	153892	Human, Mouse, Rat	WB	200ug	59670
CLSAF8309	RAD51 (Phospho-Thr309) Antibody	36966	Human, Mouse	WB	200ug	59670
CLSAF8310	S6 Ribosomal Protein (Phospho-Ser244) Antibody	28681	Human, Mouse, Rat	WB	200ug	59670
CLSAF8311	SGO1 (Phospho-Ser14) Antibody	64190	Human	WB	200ug	59670
CLSAF8312	Shc3 (Phospho-Tyr424) Antibody	64056	Human, Mouse, Rat	WB	200ug	59670
CLSAF8313	Smad1/5/9 (Phospho-Ser463+Ser465) Antibody	52260	Human	WB	200ug	59670
CLSAF8314	Smad2 (Phospho-Ser465+Ser467) Antibody	52306	Human	WB	200ug	59670
CLSAF8315	Smad3 (Phospho-Ser423+Ser425) Antibody	48081	Human	WB	200ug	59670
CLSAF8316	Smad4 (Phospho-Thr276) Antibody	60439	Human, Mouse, Rat	WB	200ug	59670
CLSAF8317	SP1 (Phospho-Thr278) Antibody	80693	Human, Mouse, Rat	WB	200ug	59670
CLSAF8318	SPHK1 (Phospho-Ser225) Antibody	42518	Human	WB	200ug	59670
CLSAF8319	SRC-1 (Phospho-Thr1179) Antibody	156757	Human, Mouse	WB	200ug	59670
CLSAF8320	SREBP-2 (Phospho-Ser455) Antibody	123688	Human, Mouse, Rat	WB	200ug	59670
CLSAF8321	SRF (Phospho-Thr159) Antibody	51593	Human, Mouse	WB	200ug	59670
CLSAF8322	STF-1 (Phospho-Ser203) Antibody	51636	Human, Mouse, Rat	WB	200ug	59670

Antibodies
HSN : 38220090

Cat#	Product Description	MW	Reactivity	Application	Pack Size	Unit Price
CLSAF8323	STMN2 (Phospho-Ser73) Antibody	20828	Human Mouse Rat	WB	200ug	59670
CLSAF8324	TAB1 (Phospho-Ser438) Antibody	54644	Human, Mouse	WB	200ug	59670
CLSAF8325	Tel (Phospho-Ser257) Antibody	53000	Human	WB	200ug	59670
CLSAF8326	TLR3 (Phospho-Tyr759) Antibody	103829	Human, Mouse, Rat	WB	200ug	59670
CLSAF8327	TLR5 (Phospho-Tyr798) Antibody	97800	Human, Mouse	WB	200ug	59670
CLSAF8328	TORC2 (Phospho-Ser171) Antibody	73302	Human, Mouse, Rat	WB	200ug	59670
CLSAF8329	TPPP (Phospho-Ser18) Antibody	23694	Human Mouse Rat	WB	200ug	59670
CLSAF8330	Tuberin (Phospho-Ser981) Antibody	200749	Human, Mouse, Rat	WB	200ug	59670
CLSAF8331	USF1 (Phospho-Thr153) Antibody	33538	Human, Mouse, Rat	WB	200ug	59670
CLSAF8332	USP28 (Phospho-Ser67) Antibody	122491	Human	WB	200ug	59670
CLSAF8333	USP28 (Phospho-Ser714) Antibody	122491	Human	WB	200ug	59670
CLSAF8334	VHL (Phospho-Ser68) Antibody	24153	Human Mouse Rat	WB	200ug	59670
CLSAF8335	XPA (Phospho-Ser196) Antibody	31368	Human, Mouse	WB	200ug	59670
CLSAF8336	XRCC4 (Phospho-Ser260) Antibody	38287	Human	WB	200ug	59670
CLSAF8337	53BP1 (Phospho-Ser1778) Antibody	213574	Human	WB	200ug	59670
CLSAF8338	Ack1 (Phospho-Tyr857+Tyr858) Antibody	114327	Human	WB	200ug	59670
CLSAF8339	ALK (Phospho-Tyr1586) Antibody	176428	Human , Mouse	WB	200ug	59670
CLSAF8340	Catenin-β (Phospho-Ser552) Antibody	85497	Human, Mouse, Rat	WB	200ug	59670
CLSAF8341	Cyclin E1 (Phospho-Ser399) Antibody	47077	Human	WB	200ug	59670
CLSAF8342	IP3 Receptor (Phospho-Tyr353) Antibody	313945	Human, Mouse, Rat	WB	200ug	59670
CLSAF8343	LRP6 (Phospho-Thr1479) Antibody	180443	Human , Mouse	WB	200ug	59670
CLSAF8344	LRP6 (Phospho-Ser1490) Antibody	180443	Human , Mouse	WB	200ug	59670
CLSAF8345	p56 Dok-2 (Phospho-Tyr345) Antibody	45379	Human, Mouse	WB	200ug	59670
CLSAF8346	PFKFB2 (Phospho-Ser466) Antibody	58477	Human, Mouse, Rat	WB	200ug	59670
CLSAF8347	PKC γ (Phospho-Thr514) Antibody	78448	Human	WB	200ug	59670
CLSAF8348	POLR2A (Phospho-Ser1616) Antibody	217206	Human , Mouse	WB	200ug	59670
CLSAF8349	PRK1/2 (Phospho-Thr774/816) Antibody	103990	Human	WB	200ug	59670
CLSAF8350	Raptor (Phospho-Ser792) Antibody	149038	Human	WB	200ug	59670
CLSAF8351	SGK1 (Phospho-Thr256) Antibody	48942	Human	WB	200ug	59670
CLSAF8352	TIF1-β (Phospho-Ser824) Antibody	88550	Human, Mouse, Rat	WB	200ug	59670
CLSAF8353	Troponin I Cardiac (Phospho-Ser23+Ser24) Antibody	24008	Human	WB	200ug	59670
CLSAF8354	TSC2 (Phospho-Ser1254) Antibody	200749	Human , Rat	WB	200ug	59670
CLSAF8355	AKT1 (Phospho-Ser473) Antibody	55686	Human, Mouse, Rat	WB	200ug	59670
CLSAF8356	AKT1 (Phospho-Ser473) Antibody	55686	Human, Mouse, Rat	WB	200ug	59670
CLSAF8357	AKT1 (Phospho-Ser473+Tyr474) Antibody	55686	Human	WB	200ug	59670
CLSAF8358	ABI1 (Phospho-Tyr212) Antibody	55081	Human, Mouse, Rat	WB	200ug	59670
CLSAF8359	ALOX5 (Phospho-Ser663) Antibody	77983	Human, Mouse, Rat	WB	200ug	59670
CLSAF8360	AQP2 (Phospho-Ser261) Antibody	28837	Human, Mouse, Rat	WB	200ug	59670
CLSAF8361	BTK (Phospho-Ser179) Antibody	76281	Human, Mouse, Rat	WB	200ug	59670
CLSAF8362	C5AR1 (Phospho-Ser334) Antibody	39321	Human Rat	WB	200ug	59670
CLSAF8363	CACNA1C (Phospho-Ser1927) Antibody	248887	Human , Mouse , Rat	WB	200ug	59670
CLSAF8364	Caspase 3 (Phospho-Ser26) Antibody	31608	Mouse, Rat	WB	200ug	59670
CLSAF8365	CDH1 (Phospho-Ser844) Antibody	97456	Human, Mouse, Rat	WB	200ug	59670
CLSAF8366	CDK5 (Phospho-Ser159) Antibody	33304	Human, Mouse, Rat	WB	200ug	59670
CLSAF8367	DDEF2 (Phospho-Ser701) Antibody	111651	Human, Mouse	WB	200ug	59670
CLSAF8368	p56 Dok-2 (Phospho-Tyr139) Antibody	45379	Human, Mouse	WB	200ug	59670
CLSAF8369	E2F1 (Phospho-Ser364) Antibody	46920	Human	WB	200ug	59670
CLSAF8370	HER4 (Phospho-Tyr1056) Antibody	146808	Human , Mouse , Rat	WB	200ug	59670
CLSAF8371	ETS1 (Phospho-Ser251) Antibody	50408	Human, Mouse, Rat	WB	200ug	59670
CLSAF8372	ETS1 (Phospho-Ser282) Antibody	50408	Human, Mouse, Rat	WB	200ug	59670
CLSAF8373	FAK (Phospho-Ser722) Antibody	119233	Human, Mouse, Rat	WB	200ug	59670
CLSAF8374	GABBR2 (Phospho-Ser884) Antibody	105821	Human, Mouse, Rat	WB	200ug	59670
CLSAF8375	GABBR2 (Phospho-Ser893) Antibody	105821	Human, Mouse, Rat	WB	200ug	59670
CLSAF8376	GRK1/2 (Phospho-Tyr13) Antibody	79574	Human Mouse Rat	WB	200ug	59670
CLSAF8377	GRK2 (Phospho-Tyr86) Antibody	79574	Human Mouse Rat	WB	200ug	59670
CLSAF8378	HDAC7A (Phospho-Ser486) Antibody	102927	Human, Mouse	WB	200ug	59670
CLSAF8379	HNRPA0 (Phospho-Ser84) Antibody	30841	Human	WB	200ug	59670
CLSAF8380	HSPB1 (Phospho-Ser15) Antibody	22783	Human	WB	200ug	59670
CLSAF8381	HtrA2 (Phospho-Ser142) Antibody	48841	Human, Mouse, Rat	WB	200ug	59670
CLSAF8382	IRF5 (Phospho-Ser437) Antibody	56044	Human, Mouse	WB	200ug	59670
CLSAF8383	IRS2 (Phospho-Ser1100) Antibody	137334	Human , Mouse	WB	200ug	59670
CLSAF8384	ITGB1 (Phospho-Tyr783) Antibody	88465	Human, Mouse, Rat	WB	200ug	59670
CLSAF8385	MDM2 (Phospho-Tyr394) Antibody	55233	Human, Mouse	WB	200ug	59670
CLSAF8386	MET (Phospho-Tyr1365) Antibody	155527	Human , Mouse , Rat	WB	200ug	59670
CLSAF8387	MLCK (Phospho-Tyr464) Antibody	210774	Human	WB	200ug	59670
CLSAF8388	MLCK (Phospho-Tyr471) Antibody	210774	Human	WB	200ug	59670
CLSAF8389	Trk B (Phospho-Tyr817) Antibody	91999	Human, Mouse, Rat	WB	200ug	59670
CLSAF8390	PLCG1 (Phospho-Ser1248) Antibody	148532	Human , Mouse , Rat	WB	200ug	59670
CLSAF8391	PLCG2 (Phospho-Tyr1197) Antibody	147918	Human , Mouse , Rat	WB	200ug	59670

Antibodies
HSN : 38220090

Cat#	Product Description	MW	Reactivity	Application	Pack Size	Unit Price
CLSAF8392	PPARA (Phospho-Ser12) Antibody	52225	Human Mouse Rat	WB	200ug	59670
CLSAF8393	PRC1 (Phospho-Thr470) Antibody	71665	Human, Mouse	WB	200ug	59670
CLSAF8394	PRC1 (Phospho-Thr481) Antibody	71665	Human	WB	200ug	59670
CLSAF8395	PRKCA (Phospho-Thr497) Antibody	76764	Human, Mouse, Rat	WB	200ug	59670
CLSAF8396	PRKCA (Phospho-Ser657) Antibody	76764	Human, Mouse, Rat	WB	200ug	59670
CLSAF8397	PRKCB1 (Phospho-Thr500) Antibody	76869	Human, Mouse, Rat	WB	200ug	59670
CLSAF8398	PRKCG (Phospho-Thr655) Antibody	78448	Human, Mouse, Rat	WB	200ug	59670
CLSAF8399	Retinoblastoma (Phospho-Thr373) Antibody	106159	Human, Mouse, Rat	WB	200ug	59670
CLSAF8400	RBL2 (Phospho-Thr642) Antibody	128367	Human, Mouse, Rat	WB	200ug	59670
CLSAF8401	RBL2 (Phospho-Ser639) Antibody	128367	Human, Mouse, Rat	WB	200ug	59670
CLSAF8402	ROCK2 (Phospho-Tyr722) Antibody	160913	Human, Mouse, Rat	WB	200ug	59670
CLSAF8403	SHC1 (Phospho-Tyr349+Tyr350) Antibody	62822	Human Mouse Rat	WB	200ug	59670
CLSAF8404	SYK (Phospho-Tyr525+Tyr526) Antibody	72066	Human Mouse Rat	WB	200ug	59670
CLSAF8405	VASP (Phospho-Thr278) Antibody	39830	Human, Mouse, Rat	WB	200ug	59670
CLSAF8406	VCL (Phospho-Tyr1133/1065) Antibody	123799	Human , Mouse , Rat	WB	200ug	59670
CLSAF8407	Androgen Receptor (Phospho-Ser791) Antibody	98989/44643	Human, Mouse, Rat	WB	200ug	59670
CLSAF8408	Androgen Receptor (Phospho-Ser308) Antibody	98989	Human	WB	200ug	59670
CLSAF8409	ATM (Phospho-Ser1981) Antibody	350714	Human	WB	200ug	59670
CLSAF8410	ATM (Phospho-Ser1987) Antibody	350714	Mouse	WB	200ug	59670
CLSAF8411	ATM (Phospho-Ser794) Antibody	350714	Human	WB	200ug	59670
CLSAF8412	AXL Antibody	98336	Human, Mouse, Rat	WB	200ug	59670
CLSAF8413	CD45 (Phospho-Tyr1216) Antibody	147254/130898	Human	WB	200ug	59670
CLSAF8414	CD66 (Phospho-Ser508) Antibody	57560/50349/46910/27431	Human	WB	200ug	59670
CLSAF8415	Chk2 (Phospho-Ser379) Antibody	60915/50203/65419/57526	Human, Mouse, Rat	WB	200ug	59670
CLSAF8416	Connexin 43 (Phospho-Ser279) Antibody	43008	Human, Mouse, Rat	WB	200ug	59670
CLSAF8417	CRMP-1 (Phospho-Thr509) Antibody	62184	Human, Mouse, Rat	WB	200ug	59670
CLSAF8418	CSFR (Phospho-Tyr921) Antibody	107984	Mouse, Rat	WB	200ug	59670
CLSAF8419	DAPK1 (Phospho-Ser308) Antibody	160046/56138	Human, Mouse	WB	200ug	59670
CLSAF8420	DDR1 (Phospho-Tyr796) Antibody	101128/97174	Human, Mouse, Rat	WB	200ug	59670
CLSAF8421	EPHA1 (Phospho-Tyr599) Antibody	108127	Human, Mouse	WB	200ug	59670
CLSAF8422	EPHA1 (Phospho-Tyr605) Antibody	108127	Human, Mouse	WB	200ug	59670
CLSAF8423	EPHA1 (Phospho-Tyr781) Antibody	108127	Human, Mouse	WB	200ug	59670
CLSAF8424	EPHA2 (Phospho-Tyr930) Antibody	108266	Human, Mouse	WB	200ug	59670
CLSAF8425	EPHA3 (Phospho-Tyr602) Antibody	110131	Human, Mouse, Rat	WB	200ug	59670
CLSAF8426	EPHA5 (Phospho-Tyr650) Antibody	114803	Human, Mouse, Rat	WB	200ug	59670
CLSAF8427	EPHA6 (Phospho-Tyr977) Antibody	116116	Human, Mouse, Rat	WB	200ug	59670
CLSAF8428	EPHA7 (Phospho-Tyr608) Antibody	112097	Human, Mouse, Rat	WB	200ug	59670
CLSAF8429	EPHB1 (Phospho-Tyr928) Antibody	109885	Human, Mouse, Rat	WB	200ug	59670
CLSAF8430	EPHB1/2 (Phospho-Tyr778/Tyr780) Antibody	109885/117493	Human Mouse Rat	WB	200ug	59670
CLSAF8431	EPHB3 (Phospho-Tyr608) Antibody	110330	Human, Mouse	WB	200ug	59670
CLSAF8432	EPHB4 (Phospho-Tyr987) Antibody	108270	Human	WB	200ug	59670
CLSAF8433	EPHB6 (Phospho-Tyr630) Antibody	110700/81211	Human, Mouse, Rat	WB	200ug	59670
CLSAF8434	EPHB6 (Phospho-Tyr636) Antibody	110700/81211	Human, Mouse, Rat	WB	200ug	59670
CLSAF8435	Epo-R (Phospho-Tyr426) Antibody	55065	Human, Mouse, Rat	WB	200ug	59670
CLSAF8436	Epo-R (Phospho-Tyr456) Antibody	55065	Human, Mouse, Rat	WB	200ug	59670
CLSAF8437	FGFR2 (Phospho-Ser782) Antibody	92025	Human, Mouse	WB	200ug	59670
CLSAF8438	FGFR3 (Phospho-Tyr577) Antibody	87710	Human	WB	200ug	59670
CLSAF8439	FGFR3 (Phospho-Tyr724) Antibody	87710	Human, Mouse, Rat	WB	200ug	59670
CLSAF8440	HER4 (Phospho-Tyr1242) Antibody	146808	Human , Mouse , Rat	WB	200ug	59670
CLSAF8441	LAT (Phospho-Tyr255) Antibody	27930	Human, Mouse, Rat	WB	200ug	59670
CLSAF8442	LTK/ALK (Phospho-Tyr672/Tyr1278) Antibody	91681/176442	Human	WB	200ug	59670
CLSAF8443	MER/TYRO3 (Phospho-Tyr753/Tyr685) Antibody	110249/96905	Human Mouse Rat	WB	200ug	59670
CLSAF8444	Met (Phospho-Tyr1313) Antibody	155527	Human , Mouse , Rat	WB	200ug	59670
CLSAF8445	Mre11 (Phospho-Ser676) Antibody	80593/77642	Human	WB	200ug	59670
CLSAF8446	MYPT1 (Phospho-Ser507) Antibody	115281	Human, Mouse	WB	200ug	59670
CLSAF8447	MYPT1/2 (Phospho-Ser668/Ser618) Antibody	115281/110404	Human Mouse Rat	WB	200ug	59670
CLSAF8448	PECAM-1 (Phospho-Tyr690) Antibody	82536	Human	WB	200ug	59670
CLSAF8449	RET (Phospho-Tyr1096) Antibody	124319	Human , Mouse , Rat,	WB	200ug	59670
CLSAF8450	ROR1 (Phospho-Tyr786) Antibody	104283/42833	Human	WB	200ug	59670
CLSAF8451	ROR2 (Phospho-Ser449) Antibody	104757	Human, Mouse	WB	200ug	59670
CLSAF8452	ROS (Phospho-Tyr2114) Antibody	263915	Human , Mouse , Rat	WB	200ug	59670
CLSAF8453	ROS (Phospho-Tyr2274) Antibody	263915	Human , Mouse , Rat	WB	200ug	59670
CLSAF8454	Smad1/9 (Phospho-Ser463/Ser465) Antibody	52260/52493	Human Mouse Rat	WB	200ug	59670
CLSAF8455	Smad3 (Phospho-Ser423) Antibody	48081	Human, Mouse, Rat	WB	200ug	59670



Antibodies

HSN : 38220090

Cat#	Product Description	MW	Reactivity	Application	Pack Size	Unit Price
CLSAF8456	TGFBR1 (Phospho-Thr204) Antibody	55960	Human, Mouse, Rat	WB	200ug	59670
CLSAF8457	SRPK1 (Phospho-Thr601) Antibody	74325	Human, Mouse	WB	200ug	59670
CLSAF8458	14-3-3ζ (Phospho-Ser186) Antibody	27774	Human, Mouse	WB	200ug	59670
CLSAF8459	ALK (Phospho-Tyr1078) Antibody	176442	Human , Mouse	WB	200ug	59670
CLSAF8460	AP-2mu (Phospho-Thr156) Antibody	49655	Human, Mouse, Rat	WB	200ug	59670
CLSAF8461	Amyloid-βA4 (Phospho-Thr729) Antibody	86943	Human, Mouse, Rat	WB	200ug	59670
CLSAF8462	ATP1A1 (Phospho-Tyr260) Antibody	112896/74140	Human, Mouse, Rat	WB	200ug	59670
CLSAF8463	Bamacan (Phospho-Ser1067) Antibody	141542	Human , Mouse , Rat	WB	200ug	59670
CLSAF8464	Bamacan (Phospho-Ser1083) Antibody	141542	Human , Mouse , Rat	WB	200ug	59670
CLSAF8465	BCL-2 (Phospho-Thr74) Antibody	26266/22141	Human	WB	200ug	59670
CLSAF8466	BCL-3 (Phospho-Ser402) Antibody	47584	Human	WB	200ug	59670
CLSAF8467	CD19 (Phospho-Tyr500) Antibody	61128	Human, Mouse	WB	200ug	59670
CLSAF8468	CD88 (Phospho-Ser327) Antibody	39336	Human	WB	200ug	59670
CLSAF8469	Cot (Phospho-Ser400) Antibody	52925/49620	Human, Mouse, Rat	WB	200ug	59670
CLSAF8470	DRP1 (Phospho-Ser616) Antibody	81877	Human, Mouse, Rat	WB	200ug	59670
CLSAF8471	eIF2B (Phospho-Ser2) Antibody	38388	Human	WB	200ug	59670
CLSAF8472	eIF2B (Phospho-Ser67) Antibody	38388	Human	WB	200ug	59670
CLSAF8473	EIF5 (Phospho-Ser389+Ser390) Antibody		Human	WB	200ug	59670
CLSAF8474	EIF6 (Phospho-Ser235) Antibody		Human, Mouse, Rat	WB	200ug	59670
CLSAF8475	FANCD2 (Phospho-Ser717) Antibody		Human	WB	200ug	59670
CLSAF8476	FANCD2 (Phospho-Thr691) Antibody		Human	WB	200ug	59670
CLSAF8477	FLT3 (Phospho-Tyr955) Antibody		Human	WB	200ug	59670
CLSAF8478	G3BP-1 (Phospho-Ser149) Antibody		Human, Mouse, Rat	WB	200ug	59670
CLSAF8479	GFAP (Phospho-Ser13) Antibody		Human	WB	200ug	59670
CLSAF8480	Glur2 (Phospho-Tyr876) Antibody		Human, Mouse, Rat	WB	200ug	59670
CLSAF8481	gp130 (Phospho-Tyr759) Antibody		Human Rat	WB	200ug	59670
CLSAF8482	H2AX (Phospho-Tyr143) Antibody		Human, Mouse, Rat	WB	200ug	59670
CLSAF8483	HP1-β (Phospho-Thr51) Antibody		Human Mouse Rat	WB	200ug	59670
CLSAF8484	HSP105 (Phospho-Ser809) Antibody		Human, Mouse, Rat	WB	200ug	59670
CLSAF8485	INCENP (Phospho-Thr59) Antibody		Human Mouse Rat	WB	200ug	59670
CLSAF8486	IRF-7 (Phospho-Ser477) Antibody		Human, Mouse, Rat	WB	200ug	59670
CLSAF8487	MCM2 (Phospho-Ser139) Antibody		Human, Mouse, Rat	WB	200ug	59670
CLSAF8488	MCM2 (Phospho-Ser27) Antibody		Human Mouse Rat	WB	200ug	59670
CLSAF8489	MCM2 (Phospho-Ser53) Antibody		Human Mouse Rat	WB	200ug	59670
CLSAF8490	Myd88 (Phospho-Tyr257) Antibody		Human, Mouse, Rat	WB	200ug	59670
CLSAF8491	NCoA3 (Phospho-Ser857) Antibody		Human, Mouse	WB	200ug	59670
CLSAF8492	NDEL1 (Phospho-Thr219) Antibody		Human, Mouse, Rat	WB	200ug	59670
CLSAF8493	NDRG1 (Phospho-Ser330) Antibody		Human, Mouse, Rat	WB	200ug	59670
CLSAF8494	NDRG1 (Phospho-Thr346) Antibody		Human, Mouse, Rat	WB	200ug	59670
CLSAF8495	NHE-3 (Phospho-Ser555) Antibody		Human Rat	WB	200ug	59670
CLSAF8496	NPM (Phospho-Ser4) Antibody		Human sR:S4	WB	200ug	59670
CLSAF8497	NPM (Phospho-Ser70) Antibody		Human Mouse Rat	WB	200ug	59670
CLSAF8498	NPM (Phospho-Thr237) Antibody		Human, Mouse, Rat	WB	200ug	59670
CLSAF8499	p21Cip1 (Phospho-Thr57) Antibody		Human Mouse Rat	WB	200ug	59670
CLSAF8500	p73 (Phospho-Ser388) Antibody		Human, Mouse	WB	200ug	59670
CLSAF8501	PDE3A (Phospho-Ser312) Antibody		Human, Mouse, Rat	WB	200ug	59670
CLSAF8502	PDHA1/2 (Phospho-Ser293/291) Antibody		Human Mouse Rat	WB	200ug	59670
CLSAF8503	PNKP (Phospho-Ser114) Antibody		Human	WB	200ug	59670
CLSAF8504	PTRF (Phospho-Tyr156) Antibody		Human, Mouse, Rat	WB	200ug	59670
CLSAF8505	Rad2/FEN1 (Phospho-Ser187) Antibody		Human, Mouse, Rat	WB	200ug	59670
CLSAF8506	Raptor (Phospho-Ser863) Antibody		Human, Mouse, Rat	WB	200ug	59670
CLSAF8507	RCC1 (Phospho-Ser11) Antibody		Human Mouse Rat	WB	200ug	59670
CLSAF8508	RON (Phospho-Tyr1353) Antibody		Human , Mouse	WB	200ug	59670
CLSAF8509	R-Ras (Phospho-Tyr66) Antibody		Human Mouse Rat	WB	200ug	59670
CLSAF8510	RSK2 (Phospho-Tyr529) Antibody		Human, Mouse	WB	200ug	59670
CLSAF8511	S100A9 (Phospho-Thr113) Antibody		Human	WB	200ug	59670
CLSAF8512	SLAM/CD150 (Phospho-Tyr281) Antibody		Human, Mouse	WB	200ug	59670
CLSAF8513	STYK1/NOK (Phospho-Tyr327) Antibody		Human, Mouse	WB	200ug	59670
CLSAF8514	SYN2 (Phospho-Ser425) Antibody		Human, Mouse, Rat	WB	200ug	59670
CLSAF8515	TALIN1 (Phospho-Ser425) Antibody		Human, Mouse	WB	200ug	59670
CLSAF8516	TOP2A (Phospho-Ser1337) Antibody		Human	WB	200ug	59670
CLSAF8517	TOPBP1 (Phospho-Ser1159) Antibody		Human , Mouse , Rat	WB	200ug	59670
CLSAF8518	Torc1/Crtc1 (Phospho-Ser151) Antibody		Human, Mouse	WB	200ug	59670
CLSAF8519	TRF2 (Phospho-Ser323) Antibody		Human	WB	200ug	59670
CLSAF8520	VR1 (Phospho-Ser503) Antibody		Mouse, Rat	WB	200ug	59670
CLSAF8521	XRCC1 (Phospho-Thr284) Antibody		Human	WB	200ug	59670
CLSAF8522	AXL (Phospho-Tyr691) Antibody		Human , Mouse , Rat	WB	200ug	59670
CLSAF8523	AXL (Phospho-Tyr702) Antibody		Human , Mouse , Rat	WB	200ug	59670
CLSAF8524	MUC1 Antibody	170kDa	Human,	WB IHC IF/ICC	200ug	59670
CLSAF8525	Phospho-YB1 (Ser102) Antibody	55kDa	Human , Mouse , Rat	WB	200ug	59670

Antibodies
HSN : 38220090

Cat#	Product Description	MW	Reactivity	Application	Pack Size	Unit Price
CLSAF9001	A Cyclase 1 Antibody	130kDa	WB	Human	200ug	59670
CLSAF9002	A1Up Antibody	54kDa	WB	Human, Mouse, Rat	200ug	59670
CLSAF9003	Acrosin Antibody	45kDa	WB IHC	Human	200ug	59670
CLSAF9004	Actin-alpha/gamma Antibody	45kDa	WB IHC	Human	200ug	59670
CLSAF9005	AIFL Antibody	67kDa	WB	Human	200ug	59670
CLSAF9006	AMPKgamma2 Antibody	65kDa	WB	Human, Mouse, Rat	200ug	59670
CLSAF9007	A-Myb Antibody	85kDa	WB	Human, Mouse, Rat	200ug	59670
CLSAF9008	ANKRD20 Antibody	95kDa	WB	Human, Mouse, Rat	200ug	59670
CLSAF9009	APOBEC3A Antibody	26kDa	WB	Human, Mouse	200ug	59670
CLSAF9010	ApoOL Antibody	30kDa	WB	Human, Mouse, Rat	200ug	59670
CLSAF9011	ARHGAP1 Antibody	50kDa	WB IHC	Human, Mouse	200ug	59670
CLSAF9012	ARHGAP22 Antibody	77kDa	WB	Human, Mouse	200ug	59670
CLSAF9013	ARHGEF19 Antibody	90kDa	WB	Human	200ug	59670
CLSAF9014	ARMCX1 Antibody	49kDa	WB	Human, Rat	200ug	59670
CLSAF9015	ARP-1 Antibody	45kDa	WB	Human	200ug	59670
CLSAF9016	Arrdc1 Antibody	48kDa	WB	Human, Rat	200ug	59670
CLSAF9017	ARRDC2 Antibody	44kDa	WB	Human	200ug	59670
CLSAF9018	Arrdc4 Antibody	45kDa	WB	Human, Mouse	200ug	59670
CLSAF9019	Arrestin-C Antibody	40kDa	WB	Human, Mouse	200ug	59670
CLSAF9020	Arylsulfatase K Antibody	61kDa	WB IHC	Human	200ug	59670
CLSAF9021	AR-beta3 Antibody	36kDa	WB IHC	Human	200ug	59670
CLSAF9022	ASF1B Antibody	26kDa	WB IHC	Human, Mouse	200ug	59670
CLSAF9023	BAM32 Antibody	32kDa	WB	Human, Mouse	200ug	59670
CLSAF9024	BEGAIN Antibody	65kDa	WB	Human	200ug	59670
CLSAF9025	BRD3 Antibody	90kDa	WB IHC	Human	200ug	59670
CLSAF9026	BTBD6 Antibody	45kDa	WB IHC	Human	200ug	59670
CLSAF9027	C/EBP δ/ε Antibody	28kDa	WB	Human	200ug	59670
CLSAF9028	C/EBP δ Antibody	120kDa	WB IHC	Human	200ug	59670
CLSAF9029	Cables2 Antibody	60kDa	WB	Human, Mouse, Rat	200ug	59670
CLSAF9030	CaMKIIbeta/gamma Antibody	62kDa	WB	Human	200ug	59670
CLSAF9031	CaMKIbeta Antibody	38kDa	WB	Human	200ug	59670
CLSAF9032	CAS Antibody	110kDa	WB	Human	200ug	59670
CLSAF9033	Casein Kinase Igamma1 Antibody	49kDa	WB	Human, Mouse, Rat	200ug	59670
CLSAF9034	Casein Kinase Igamma2 Antibody	47kDa	WB IHC	Human, Mouse, Rat	200ug	59670
CLSAF9035	Caspase-14 Antibody	27kDa	WB	Human	200ug	59670
CLSAF9036	CTNNA1/CTNNA2 Antibody	100kDa	WB	Human	200ug	59670
CLSAF9037	CD158f2 Antibody	40kDa	WB	Human	200ug	59670
CLSAF9038	CD32 Antibody	34kDa	WB	Human	200ug	59670
CLSAF9039	Cdc16 Antibody	72kDa	WB	Human	200ug	59670
CLSAF9040	Centrobins Antibody	100kDa	WB	Human, Mouse	200ug	59670
CLSAF9041	CEP152 Antibody	140kDa	WB	Human	200ug	59670
CLSAF9042	CMTM4 Antibody	25kDa	WB	Human	200ug	59670
CLSAF9043	CNOT2 Antibody	46kDa	WB	Human	200ug	59670
CLSAF9044	COL19A1 Antibody	120kDa	WB IHC	Human	200ug	59670
CLSAF9045	COL4A6 Antibody	160kDa	WB IHC	Human, Mouse, Rat	200ug	59670
CLSAF9046	COL5A3 Antibody	170kDa	WB	Human	200ug	59670
CLSAF9047	Copine 8 Antibody	65kDa	WB	Human	200ug	59670
CLSAF9048	COX7a2/3 Antibody	12kDa	WB	Human, Mouse, Rat	200ug	59670
CLSAF9049	CRSP130 Antibody	150kDa	WB	Human	200ug	59670
CLSAF9050	CYB561D1 Antibody	23kDa	WB	Human, Mouse, Rat	200ug	59670
CLSAF9051	CYP4F2 Antibody	60kDa	WB	Human	200ug	59670
CLSAF9052	DCL-1 Antibody	26kDa	WB IHC	Human	200ug	59670
CLSAF9053	DEF-3 Antibody	160kDa	WB	Human, Mouse	200ug	59670
CLSAF9054	DHHC-9 Antibody	41kDa	WB	Human, Mouse, Rat	200ug	59670
CLSAF9055	DNA pol λ Antibody	63kDa	WB	Human, Mouse	200ug	59670
CLSAF9056	Dynein IC1 Antibody	79kDa	WB	Human	200ug	59670
CLSAF9057	EF-Tu Antibody	50kDa	WB	Human, Mouse	200ug	59670
CLSAF9058	Eg5 Antibody	119kDa	WB	Human	200ug	59670
CLSAF9059	Elongin A1 Antibody	87kDa	WB	Human, Mouse	200ug	59670
CLSAF9060	Ephrin-B3 Antibody	36kDa	WB	Human	200ug	59670
CLSAF9061	Eps8L3 Antibody	67kDa	WB IHC	Human, Mouse	200ug	59670
CLSAF9062	eRF3a Antibody	55kDa	WB IHC	Human	200ug	59670
CLSAF9063	ETL Antibody	77kDa	WB IHC	Human, Mouse	200ug	59670
CLSAF9064	FAM80B Antibody	42kDa	WB	Human	200ug	59670
CLSAF9065	FBP3 Antibody	60kDa	WB	Human, Mouse	200ug	59670
CLSAF9066	FGF-22 Antibody	20kDa	WB IHC	Human, Mouse	200ug	59670
CLSAF9067	FoxR1 Antibody	35kDa	WB IHC	Human, Mouse, Rat	200ug	59670
CLSAF9068	GAAP Antibody	23kDa	WB	Human	200ug	59670
CLSAF9069	GALR3 Antibody	40kDa	WB IHC	Human	200ug	59670
CLSAF9070	GAS3 Antibody	22kDa	WB	Human, Mouse, Rat	200ug	59670

Antibodies
HSN : 38220090

Cat#	Product Description	MW	Reactivity	Application	Pack Size	Unit Price
CLSAF9071	GBP4 Antibody	73kDa	WB	Human, Mouse, Rat	200ug	59670
CLSAF9072	Glucosidase II alpha Antibody	107kDa	WB	Human, Mouse	200ug	59670
CLSAF9073	GPR124 Antibody	145kDa	WB	Human	200ug	59670
CLSAF9074	GPR139 Antibody	40kDa	WB	Human	200ug	59670
CLSAF9075	GPR41 Antibody	38kDa	WB IHC	Human	200ug	59670
CLSAF9076	GPR50 Antibody	68kDa	WB	Human	200ug	59670
CLSAF9077	GPRC5C Antibody	48kDa	WB	Human, Mouse, Rat	200ug	59670
CLSAF9078	Granzyme H Antibody	23kDa	WB IHC	Human, Mouse	200ug	59670
CLSAF9079	Grp Antibody	28kDa	WB IHC	Human, Mouse	200ug	59670
CLSAF9080	GRB10 Antibody	67kDa	WB	Human	200ug	59670
CLSAF9081	GRIN2 Antibody	47kDa	WB	Human	200ug	59670
CLSAF9082	GS28 Antibody	37kDa	WB	Human, Mouse	200ug	59670
CLSAF9083	HABP2 Antibody	63kDa	WB	Human, Mouse	200ug	59670
CLSAF9084	HC-II Antibody	57kDa	WB	Human, Mouse, Rat	200ug	59670
CLSAF9085	HEN1/2 Antibody	19kDa	WB	Human	200ug	59670
CLSAF9086	Histamine H4 Receptor Antibody	45kDa	WB IHC	Human	200ug	59670
CLSAF9087	Histone deacetylase 9 Polyclonal Antibody	110kDa	WB	Human, Mouse, Rat	200ug	59670
CLSAF9088	HORMAD1 Antibody	45kDa	WB	Human	200ug	59670
CLSAF9089	HoxD10 Antibody	32kDa	WB	Human	200ug	59670
CLSAF9090	HoxD8 Antibody	32kDa	WB	Human	200ug	59670
CLSAF9091	HP1gamma Antibody	22kDa	WB	Human, Mouse, Rat	200ug	59670
CLSAF9092	HRT2 Antibody	36kDa	WB	Human, Mouse, Rat	200ug	59670
CLSAF9093	IFI-56K Antibody	55kDa	WB	Human, Mouse, Rat	200ug	59670
CLSAF9094	IFN-gammaRalpha Antibody	83kDa	WB	Human, Mouse	200ug	59670
CLSAF9095	IL-13Ralpha1 Antibody	49kDa	WB IHC	Human, Mouse, Rat	200ug	59670
CLSAF9096	IL-1R9 Antibody	79kDa	WB IHC	Human, Mouse	200ug	59670
CLSAF9097	InsP5 2-kinase Antibody	56kDa	WB IHC	Human, Mouse	200ug	59670
CLSAF9098	INTS2 Antibody	140kDa	WB	Human	200ug	59670
CLSAF9099	KCNT1 Antibody	140kDa	WB	Human, Rat	200ug	59670
CLSAF9100	KIF13B Antibody	202kDa	WB IHC	Human	200ug	59670
CLSAF9101	KIR3.1 Antibody	43kDa	WB IHC	Human, Rat	200ug	59670
CLSAF9102	KIR3.4 Antibody	48kDa	WB	Human	200ug	59670
CLSAF9103	KVbeta.3 Antibody	45kDa	WB IHC	Human, Mouse	200ug	59670
CLSAF9104	LHR Antibody	80kDa	WB	Human, Mouse	200ug	59670
CLSAF9105	LONP2 Antibody	95kDa	WB	Human	200ug	59670
CLSAF9106	LRP10 Antibody	76kDa	WB	Human	200ug	59670
CLSAF9107	LUC7L2 Antibody	47kDa	WB	Human, Mouse	200ug	59670
CLSAF9108	mACHR M4 Antibody	53kDa	WB	Human, Mouse	200ug	59670
CLSAF9109	Matriptase Antibody	95kDa	WB IHC	Human	200ug	59670
CLSAF9110	MCT12 Antibody	53kDa	WB	Human	200ug	59670
CLSAF9111	ME2 Antibody	65kDa	WB	Human	200ug	59670
CLSAF9112	MINK1 Antibody	150kDa	WB	Human	200ug	59670
CLSAF9113	MKP-2 Antibody	44kDa	WB	Human	200ug	59670
CLSAF9114	Mob3C Antibody	22kDa	WB	Human, Mouse, Rat	200ug	59670
CLSAF9115	MPP1 Antibody	210kDa	WB	Human	200ug	59670
CLSAF9116	MRCKbeta Antibody	194kDa	WB IHC	Human	200ug	59670
CLSAF9117	MRGF Antibody	40kDa	WB IHC	Human	200ug	59670
CLSAF9118	MRLC2 Antibody	18kDa	WB	Human, Mouse, Rat	200ug	59670
CLSAF9119	MRP-L48 Antibody	23kDa	WB	Human, Mouse, Rat	200ug	59670
CLSAF9120	Na+ CP type IXalpha Antibody	220kDa	WB	Human	200ug	59670
CLSAF9121	Na+ CP type VIIalpha Antibody	200kDa	WB	Human	200ug	59670
CLSAF9122	Nanog P8 Antibody	35kDa	WB	Human	200ug	59670
CLSAF9123	NCAM-L1 Antibody	180kDa	WB	Human	200ug	59670
CLSAF9124	NDUFS5 Antibody	15kDa	WB IHC	Human	200ug	59670
CLSAF9125	Nek9 Antibody	107kDa	WB	Human, Mouse	200ug	59670
CLSAF9126	Neuralized-1 Antibody	62kDa	WB	Human	200ug	59670
CLSAF9127	Neurexin I Antibody	150kDa	WB	Human	200ug	59670
CLSAF9128	NFATc2IP Antibody	48kDa	WB	Human	200ug	59670
CLSAF9129	NFRkB Antibody	110kDa	WB	Human	200ug	59670
CLSAF9130	Nicalin Antibody	63kDa	WB	Human, Mouse, Rat	200ug	59670
CLSAF9131	Nidogen Antibody	136kDa	WB	Human	200ug	59670
CLSAF9132	NIPA Antibody	55kDa	WB	Human	200ug	59670
CLSAF9133	NMUR1 Antibody	48kDa	WB IHC	Human, Mouse, Rat	200ug	59670
CLSAF9134	Nox3 Antibody	65kDa	WB IHC	Human	200ug	59670
CLSAF9135	NRIP3 Antibody	27kDa	WB IHC	Human, Mouse, Rat	200ug	59670
CLSAF9136	Oct-6 Antibody	45kDa	WB	Human	200ug	59670
CLSAF9137	Olfactory receptor 13C8 Antibody	35kDa	WB	Human	200ug	59670
CLSAF9138	Olfactory receptor 2A42 Antibody	34kDa	WB IHC	Human, Mouse	200ug	59670
CLSAF9139	Olfactory receptor 2C3 Antibody	36kDa	WB IHC	Human, Mouse, Rat	200ug	59670
CLSAF9140	Olfactory receptor 4N4 Antibody	36kDa	WB	Human, Mouse	200ug	59670

Antibodies
HSN : 38220090

Cat#	Product Description	MW	Reactivity	Application	Pack Size	Unit Price
CLSAF9141	Olfactory receptor 51F2 Antibody	37kDa	WB IHC	Human	200ug	59670
CLSAF9142	Olfactory receptor 51I1 Antibody	35kDa	WB	Human, Mouse	200ug	59670
CLSAF9143	Olfactory receptor 52K1 Antibody	40kDa	WB	Human	200ug	59670
CLSAF9144	Olfactory receptor 5AP2 Antibody	35kDa	WB	Human, Mouse	200ug	59670
CLSAF9145	Olfactory receptor 5B12 Antibody	35kDa	WB	Human	200ug	59670
CLSAF9146	OMG Antibody	48kDa	WB	Human, Mouse	200ug	59670
CLSAF9147	OTUB2 Antibody	27kDa	WB IHC	Human	200ug	59670
CLSAF9148	Oxr1 Antibody	85kDa	WB	Human, Mouse	200ug	59670
CLSAF9149	PAK5/6 Antibody	75kDa	WB	Human	200ug	59670
CLSAF9150	PDE10A Antibody	75kDa	WB	Human, Mouse	200ug	59670
CLSAF9151	PDE4B/C/D Antibody	76kDa	WB IHC	Human, Mouse	200ug	59670
CLSAF9152	PEG3 Antibody	181kDa	WB IHC	Human, Mouse, Rat	200ug	59670
CLSAF9153	Peropsin Antibody	37kDa	WB	Human	200ug	59670
CLSAF9154	PHF3 Antibody	230kDa	WB	Human	200ug	59670
CLSAF9155	PHKA1/2 Antibody	137kDa	WB	Human, Mouse, Rat	200ug	59670
CLSAF9156	PHKB Antibody	124kDa	WB	Human, Mouse, Rat	200ug	59670
CLSAF9157	Photomedin-2 Antibody	84kDa	WB	Human, Mouse	200ug	59670
CLSAF9158	PI 3-kinase p101 Antibody	100kDa	WB	Human	200ug	59670
CLSAF9159	PIG3 Antibody	36kDa	WB IHC	Human	200ug	59670
CLSAF9160	PIPOX Antibody	44kDa	WB	Human	200ug	59670
CLSAF9161	PKAalpha/beta/gamma cat Antibody	40kDa	WB	Human	200ug	59670
CLSAF9162	PLA1A Antibody	50kDa	WB	Human, Mouse, Rat	200ug	59670
CLSAF9163	Pmp24 Antibody	24kDa	WB	Human, Mouse	200ug	59670
CLSAF9164	PNPase Antibody	85kDa	WB	Human, Mouse	200ug	59670
CLSAF9165	POLR3B Antibody	128kDa	WB	Human	200ug	59670
CLSAF9166	POLR3E Antibody	80kDa	WB	Human	200ug	59670
CLSAF9167	POTE14/22 Antibody	67kDa	WB	Human, Mouse	200ug	59670
CLSAF9168	POTE-14/22 Antibody	61kDa	WB IHC	Human, Mouse	200ug	59670
CLSAF9169	PRPF31 Antibody	55kDa	WB IHC	Human, Mouse, Rat	200ug	59670
CLSAF9170	PSK-H1 Antibody	48kDa	WB IHC	Human	200ug	59670
CLSAF9171	PTP IA-2beta Antibody	111kDa	WB	Human	200ug	59670
CLSAF9172	QSK Antibody	140kDa	WB	Human, Mouse, Rat	200ug	59670
CLSAF9173	Rab 11B Antibody	28kDa	WB IHC	Human	200ug	59670
CLSAF9174	Rab 34 Antibody	29kDa	WB IHC	Human	200ug	59670
CLSAF9175	Rab11-FIP4 Antibody	72kDa	WB	Human	200ug	59670
CLSAF9176	RAB31P Antibody	53kDa	WB IHC	Human, Mouse, Rat	200ug	59670
CLSAF9177	Rabr Antibody	49kDa	WB	Human, Mouse, Rat	200ug	59670
CLSAF9178	Rac1/2/3/CDC42 Antibody	28kDa	WB	Human, Mouse, Rat	200ug	59670
CLSAF9179	RBM34 Antibody	50kDa	WB	Human, Mouse	200ug	59670
CLSAF9180	RCC2 Antibody	56kDa	WB	Human, Mouse, Rat	200ug	59670
CLSAF9181	RFX3 Antibody	84kDa	WB	Human, Mouse	200ug	59670
CLSAF9182	Rho G Antibody	23kDa	WB IHC	Human, Mouse	200ug	59670
CLSAF9183	RHOBTB3 Antibody	70kDa	WB IHC	Human	200ug	59670
CLSAF9184	Ribosomal Protein S13 Antibody	17kDa	WB	Human, Rat	200ug	59670
CLSAF9185	Ribosomal Protein S2 Antibody	31kDa	WB	Human	200ug	59670
CLSAF9186	Rim4 Antibody	30kDa	WB	Human, Rat	200ug	59670
CLSAF9187	RREB1 Antibody	180kDa	WB	Human	200ug	59670
CLSAF9188	Rsk-4 Antibody	84kDa	WB	Human, Mouse	200ug	59670
CLSAF9189	Rsu-1 Antibody	36kDa	WB	Human, Mouse	200ug	59670
CLSAF9190	RTCD1 Antibody	34kDa	WB IHC	Human	200ug	59670
CLSAF9191	RXRgamma Antibody	50kDa	WB	Human	200ug	59670
CLSAF9192	SAF-A2 Antibody	85kDa	WB	Human, Mouse	200ug	59670
CLSAF9193	SCAF1 Antibody	139kDa	WB	Human, Mouse	200ug	59670
CLSAF9194	SCAND1 Antibody	70+25kDa	WB	Human	200ug	59670
CLSAF9195	Separase Antibody	230kDa	WB	Human	200ug	59670
CLSAF9196	Septin 1 Antibody	41kDa	WB	Human	200ug	59670
CLSAF9197	Septin 8 Antibody	50kDa	WB	Human	200ug	59670
CLSAF9198	SH3BGR Antibody	26kDa	WB	Human	200ug	59670
CLSAF9199	Sin3B Antibody	130kDa	WB IHC	Human, Mouse, Rat	200ug	59670
CLSAF9200	Sp3/4 Antibody	82kDa	WB IHC	Human	200ug	59670
CLSAF9201	SphK2 Antibody	70 - 80kDa	WB IHC	Human	200ug	59670
CLSAF9202	Splicing factor 1 Antibody	68kDa	WB	Human	200ug	59670
CLSAF9203	STAM2 Antibody	58kDa	WB	Human, Mouse, Rat	200ug	59670
CLSAF9204	Stip1 Antibody	93kDa	WB IHC	Human, Mouse, Rat	200ug	59670
CLSAF9205	SUHW1 Antibody	50kDa	WB IHC	Human	200ug	59670
CLSAF9206	SYT Antibody	45kDa	WB	Human	200ug	59670
CLSAF9207	TAB182 Antibody	150kDa	WB	Human	200ug	59670
CLSAF9208	TAUT Antibody	70kDa	WB	Human	200ug	59670
CLSAF9209	TBL2 Antibody	50kDa	WB	Human	200ug	59670
CLSAF9210	TBX2 Antibody	74kDa	WB	Human, Mouse	200ug	59670

Antibodies

HSN : 38220090

Cat#	Product Description	MW	Reactivity	Application	Pack Size	Unit Price
CLSAF9211	TCFL5 Antibody	48kDa	WB	Human	200ug	59670
CLSAF9212	TDE1 Antibody	52kDa	WB IHC	Human	200ug	59670
CLSAF9213	TIS11B Antibody	36kDa	WB	Human	200ug	59670
CLSAF9214	TLE4 Antibody	83kDa	WB	Human	200ug	59670
CLSAF9215	TMC8 Antibody	81kDa	WB	Human, Mouse, Rat	200ug	59670
CLSAF9216	TOB1 Antibody	40kDa	WB	Human	200ug	59670
CLSAF9217	TRF1 Antibody	50kDa	WB	Human	200ug	59670
CLSAF9218	TRalpha Antibody	55kDa	WB	Human, Mouse, Rat	200ug	59670
CLSAF9219	TUTase Antibody	95kDa	WB	Human	200ug	59670
CLSAF9220	Uba5 Antibody	45kDa	WB	Human, Mouse, Rat	200ug	59670
CLSAF9221	UBE3B Antibody	123kDa	WB IHC	Human	200ug	59670
CLSAF9222	UMP-CMP Kinase Antibody	22kDa	WB IHC	Human	200ug	59670
CLSAF9223	USP36 Antibody	125kDa	WB IHC	Human, Mouse	200ug	59670
CLSAF9224	USP40 Antibody	140kDa	WB	Human, Mouse, Rat	200ug	59670
CLSAF9225	USP50 Antibody	38kDa	WB	Human, Mouse	200ug	59670
CLSAF9226	V1RL3 Antibody	35kDa	WB IHC	Human	200ug	59670
CLSAF9227	V-ATPase H Antibody	55kDa	WB IHC	Human, Mouse	200ug	59670
CLSAF9228	Vav2 Antibody	101kDa	WB	Human	200ug	59670
CLSAF9229	WAVE1 Antibody	70kDa	WB IHC	Human, Mouse	200ug	59670
CLSAF9230	WAVE4 Antibody	68kDa	WB	Human	200ug	59670
CLSAF9231	WBSR11 Antibody	106kDa	WB	Human, Mouse	200ug	59670
CLSAF9232	WDHD1 Antibody	126kDa	WB	Human	200ug	59670
CLSAF9233	YEATS2 Antibody	150kDa	WB	Human, Mouse	200ug	59670
CLSAF9234	ZIP2 Antibody	36kDa	WB	Human	200ug	59670
CLSAF9235	ZNF262 Antibody	175kDa	WB IHC	Human, Mouse	200ug	59670
CLSAF9236	ZNF608 Antibody	160kDa	WB	Human, Mouse	200ug	59670
CLSAF9237	ZNF785 Antibody	87kDa	WB	Human, Mouse, Rat	200ug	59670
CLSAF9238	CSGALNACT1 Antibody	61kDa	WB	Human	200ug	59670

Reach us out



Telephone +91-120-4968617

E-mail sales@compositelabline.com

Website www.compositelabline.com

Cat.No.	Product Description	Pack Size	HSN	Unit Price
CLSPM001	BLUltra Prestained Protein Ladder	500ul	38220090	8,250.00
CLSBK001	CLS, LED Transilluminator	Set	38220090	52,000.00
CLS-G10	Tissue Grinder	0.2kg	38220090	28,000.00
CLS-G20	Tissue Grinder	0.2kg	38220090	25,500.00
CLS-G50	Tissue Grinder	145g	38220090	42,000.00
CLS01-125	CLS 5 Minute Protein Stain Kit	1Kit	38220090	5,500.00
CLS01-500	CLS 5 Minute Protein Stain Kit	1Kit	38220090	23,250.00
CLS05-125	CLS 5 Minute Protein Stain Kit (5X)	1Kit	38220090	23,250.00
CLS05-500	CLS 5 Minute Protein Stain Kit (5X)	1Kit	38220090	80,250.00
CLS10-IL	CLS 5 Minute Protein Stain Kit (10X)	1Kit	38220090	317,500.00
CLS-1001	CLS LE Agarose	500G	38220090	12,500.00
CLS-203	CLS LOW MELTING Agarose	500G	38220090	99,000.00
CLS0001HU	Human Interleukin 1,IL-1 ELISA Kit	96 Test	38220090	24,500.00
CLS0002HU	Human cholecystokinin,CCK ELISA Kit	96 Test	38220090	24,500.00
CLS0003HU	Human chemerin ELISA Kit	96 Test	38220090	24,500.00
CLS0004HU	Human carcinoembryonic antigen,CEA ELISA Kit	96 Test	38220090	24,500.00
CLS0005HU	Human calmodulin,CAM ELISA Kit	96 Test	38220090	24,500.00
CLS0006HU	Human C-type natriuretic peptide,CNP ELISA Kit	96 Test	38220090	24,500.00
CLS0007HU	Human Bone morphogenetic protein 4,BMP-4 ELISA Kit	96 Test	38220090	24,500.00
CLS0008HU	Human BH3 interacting domain death agonist,Bid ELISA Kit	96 Test	38220090	24,500.00
CLS0009HU	Human B lymphocyte stimulator,BLyS ELISA Kit	96 Test	38220090	24,500.00
CLS0010HU	Human B cell activating factor of TNF family,BAFF ELISA Kit	96 Test	38220090	24,500.00
CLS0011HU	Human androgen ELISA Kit	96 Test	38220090	24,500.00
CLS0012HU	Human Androgen Binding Protein,ABP ELISA Kit	96 Test	38220090	24,500.00
CLS0013HU	Human fatty acid binding protein,FABP4/A-FABP ELISA Kit	96 Test	38220090	24,500.00
CLS0014HU	Human adenosine deaminase,ADA ELISA Kit	96 Test	38220090	24,500.00
CLS0015HU	Human acetylcholine Receptor(ACHR) ELISA Kit	96 Test	38220090	24,500.00
CLS0016HU	Human 8-Hydroxy-desoxyguanosine,8-OHdG ELISA Kit	96 Test	38220090	24,500.00
CLS0017HU	Human colon cancer-specific antigen-4,CCSA-4 ELISA kit	96 Test	38220090	24,500.00
CLS0018HU	Human cholest erolester transfer protein/lipid transfer protein,CETP/LTP ELISA Kit	96 Test	38220090	24,500.00
CLS0019HU	Human Adropin,AD ELISA kit	96 Test	38220090	24,500.00
CLS0020HU	Human Adrenergic Receptor Beta 3(ADRB3)ELISA Kit	96 Test	38220090	24,500.00
CLS0021HU	Human adrenal cortex antibody,ACA ELISA Kit	96 Test	38220090	24,500.00
CLS0022HU	Human A Disintegrin And Metalloprotease 28 (ADAM28)ELISA Kit	96 Test	38220090	24,500.00
CLS0023HU	Human Adipose Triglyceride Lipase(ATGL)ELISA Kit	96 Test	38220090	24,500.00
CLS0024HU	Human adiponectin,C1Q and collagen domain containing(ADIPOQ)ELISA Kit	96 Test	38220090	24,500.00
CLS0025HU	Human Adenosine triphosphate(ATP) ELISA Kit	96 Test	38220090	24,500.00
CLS0026HU	Human Adenosine diphosphate,ADP ELISA Kit	96 Test	38220090	24,500.00
CLS0027HU	Human apoprotein A5,apo-A5 ELISA Kit	96 Test	38220090	24,500.00
CLS0028HU	Human Apolipoprotein M,Apo-M ELISA Kit	96 Test	38220090	24,500.00
CLS0029HU	Human Apolipoprotein H/Beta-2-glycoprotein 1,apo-H ELISA Kit	96 Test	38220090	24,500.00
CLS0030HU	Human Apelin 36,AP36 ELISA Kit	96 Test	38220090	24,500.00
CLS0031HU	Human Anti-Type II Collagen Antibody,Anti-CIIAb ELISA Kit	96 Test	38220090	24,500.00
CLS0032HU	Human Anti-tissue transglutaminase IgA,tTG-IgA ELISA kit	96 Test	38220090	24,500.00
CLS0033HU	Human anti-Thyroid-Peroxidase antibody,TPO-Ab ELISA Kit	96 Test	38220090	24,500.00
CLS0034HU	human Anti-Thyroid Microsome Antibody,ATMA/TMAB ELISA KIT	96 Test	38220090	24,500.00
CLS0035HU	Human anti-teichoic acid antibody,TA ELISA Kit	96 Test	38220090	24,500.00
CLS0036HU	Human anti-sperm antibody,AsAb ELISA Kit	96 Test	38220090	24,500.00
CLS0037HU	Human anti-scl70 antibody,SCL70/topo I ELISA Kit	96 Test	38220090	24,500.00

Cat.No.	Product Description	Pack Size	HSN	Unit Price
CLS0038HU	Human Anti-Oxidized Low Density Lipoprotein Antibody (OLAb)ELISA kit	96 Test	38220090	24,500.00
CLS0039HU	Human anti-OJ-antibody,OJ/IleRS ELISA Kit	96 Test	38220090	24,500.00
CLS0040HU	Human anti-nuclear factor Antibody,ANF ELISA Kit	96 Test	38220090	24,500.00
CLS0041HU	Human anti-neutrophil granules antibody,ANGA ELISA Kit	96 Test	38220090	24,500.00
CLS0042HU	Human anti-neutrophil antibody,ANA ELISA Kit	96 Test	38220090	24,500.00
CLS0043HU	Human anti-IgE receptor antibody(anti-IgE receptor antibody)ELISA Kit	96 Test	38220090	24,500.00
CLS0044HU	Human anti-Granulocyte-Macrophage Colony Stimulating Factor antibody,GM-CSF Ab ELISA Kit	96 Test	38220090	24,500.00
CLS0045HU	Human anti-golgi apparatus antibody,AGAA ELISA Kit	96 Test	38220090	24,500.00
CLS0046HU	Human anti-Glucose transporter 4 antibody,anti-GLUT4 ELISA Kit	96 Test	38220090	24,500.00
CLS0047HU	Human anti-gliadin antibody,AGA ELISA Kit	96 Test	38220090	24,500.00
CLS0048HU	Human anti-ganglioside antibody,GM4 ELISA Kit	96 Test	38220090	24,500.00
CLS0049HU	Human anti-ganglioside antibody,GM3 ELISA Kit	96 Test	38220090	24,500.00
CLS0050HU	Human anti-follicle-stimulating hormone(FSH-AB)ELISA Kit	96 Test	38220090	24,500.00
CLS0051HU	Human anti-endothelial cell antibody,AECA ELISA Kit	96 Test	38220090	24,500.00
CLS0052HU	Human anti-Endomysial Antibody IgG,EMA IgG ELISA Kit	96 Test	38220090	24,500.00
CLS0053HU	Human anti-Endomysial Antibody IgA,EMA IgA ELISA Kit	96 Test	38220090	24,500.00
CLS0054HU	Human anti-deoxyribonuclease B,anti-DNase B ELISA Kit	96 Test	38220090	24,500.00
CLS0055HU	Human Anti-Complement 1q antibody,C1q ELISA Kit	96 Test	38220090	24,500.00
CLS0056HU	Human anti-cartilage-antibody(anti-cartilage-Ab) ELISA Kit	96 Test	38220090	24,500.00
CLS0057HU	Human anti-cardiolipin antibody IgM,ACA-IgM ELISA Kit	96 Test	38220090	24,500.00
CLS0058HU	Human Annexin A2,Anxa2 ELISA Kit	96 Test	38220090	24,500.00
CLS0059HU	Human Annexin A1 (ANXA1)ELISA Kit	96 Test	38220090	24,500.00
CLS0060HU	Human Annexin V ,ANX- V ELISA Kit	96 Test	38220090	24,500.00
CLS0061HU	Human angiotensin I ,Ang- I ELISA Kit	96 Test	38220090	24,500.00
CLS0062HU	Human angiotensinogen,aGT ELISA Kit	96 Test	38220090	24,500.00
CLS0063HU	Human Angiotensin II Receptor 2 antibody,AT2R-Ab ELISA Kit	96 Test	38220090	24,500.00
CLS0064HU	Human Angiotensin I Converting Enzyme,ACE I ELISA Kit	96 Test	38220090	24,500.00
CLS0065HU	Human Angiotensin converting enzyme,ACE ELISA Kit	96 Test	38220090	24,500.00
CLS0066HU	Human Angiotensin 1-9 (Ang1-9)ELISA Kit	96 Test	38220090	24,500.00
CLS0067HU	Human Angiopoietin-like protein 8,ANGPTL8 ELISA Kit	96 Test	38220090	24,500.00
CLS0068HU	Human Angiopoietin Like Protein 6 (ANGPTL6)ELISA kit	96 Test	38220090	24,500.00
CLS0069HU	Human Angiopoietin 2,ANG-2 ELISA Kit	96 Test	38220090	24,500.00
CLS0070HU	Human amyloid beta peptide 1-42,Aβ1-42 ELISA Kit	96 Test	38220090	24,500.00
CLS0071HU	Human Alpha-Synuclein,SNCA ELISA Kit	96 Test	38220090	24,500.00
CLS0072HU	Human alpha-linolenic acid(ALA) ELISA Kit	96 Test	38220090	24,500.00
CLS0073HU	Human α-glutathione S-transferases,α-GST ELISA Kit	96 Test	38220090	24,500.00
CLS0074HU	Human α-Glucosidase,a-Glu ELISA Kit	96 Test	38220090	24,500.00
CLS0075HU	Human Alpha-fetoprotein,AFP ELISA Kit	96 Test	38220090	24,500.00
CLS0076HU	Human alpha-fetoprotein Lens culinaris agglutinin 2,AFP-L2 ELISA Kit	96 Test	38220090	24,500.00
CLS0077HU	Human alpha-fetoprotein Lens culinaris agglutinin 1,AFP-L1 ELISA Kit	96 Test	38220090	24,500.00
CLS0078HU	Human alpha-1-microglobulin bikunin precursor,AMBP ELISA Kit	96 Test	38220090	24,500.00
CLS0079HU	human aldosterone,ALD ELISA Kit	96 Test	38220090	24,500.00
CLS0080HU	Human aldehyde dehydrogenase 2,ALDH2 ELISA kit	96 Test	38220090	24,500.00
CLS0081HU	Human albumin(ALB)ELISA Kit	96 Test	38220090	24,500.00
CLS0082HU	Human Alanine Aminotransferase,ALT/GPT ELISA Kit	96 Test	38220090	24,500.00
CLS0083HU	Human Agouti Related Protein,AGRP ELISA Kit	96 Test	38220090	24,500.00
CLS0084HU	Human Agmatine ureohydrolase,AGMAT ELISA Kit	96 Test	38220090	24,500.00

Cat.No.	Product Description	Pack Size	HSN	Unit Price
CLS0085HU	Human advanced oxidation protein products,AOPP ELISA Kit	96 Test	38220090	24,500.00
CLS0086HU	Human arginine vasopressin,AVP ELISA Kit	96 Test	38220090	24,500.00
CLS0087HU	Human Arginine decarboxylase,ADC ELISA Kit	96 Test	38220090	24,500.00
CLS0088HU	Human Arachidonic Acid,AA ELISA Kit	96 Test	38220090	24,500.00
CLS0089HU	Human apoptosis protease activating factor-1,Apaf-1 ELISA Kit	96 Test	38220090	24,500.00
CLS0090HU	Human apoptosis inducing factor,AIF ELISA Kit	96 Test	38220090	24,500.00
CLS0091HU	Human calnexin,CNX ELISA Kit	96 Test	38220090	24,500.00
CLS0092HU	Human Calcitonin,CT ELISA Kit	96 Test	38220090	24,500.00
CLS0093HU	Human calcitonin gene related peptide,CGRP ELISA Kit	96 Test	38220090	24,500.00
CLS0094HU	Human Calbindin (CALB)ELISA Kit	96 Test	38220090	24,500.00
CLS0095HU	Human Cadherin 11 (CDH11/CAD11)ELISA Kit	96 Test	38220090	24,500.00
CLS0096HU	Human Ceruloplasmin,CP/CER ELISA Kit	96 Test	38220090	24,500.00
CLS0097HU	Human Cerebral Dopamine Neurotrophic Factor (CDNF)ELISA Kit	96 Test	38220090	24,500.00
CLS0098HU	human CD163 antigen,CD163 ELISA kit	96 Test	38220090	24,500.00
CLS0099HU	Human CC-chemokine receptor 1,CCR-1 ELISA Kit	96 Test	38220090	24,500.00
CLS0100HU	Human CCAAT/enhancer binding protein beta,C/EBPβ ELISA Kit	96 Test	38220090	24,500.00
CLS0101HU	Human CCAAT/enhancer binding protein alpha,C/EBPα ELISA Kit	96 Test	38220090	24,500.00
CLS0102HU	Human CC Chemokine receptor 7,CCR-7 ELISA Kit	96 Test	38220090	24,500.00
CLS0103HU	Human Caveolin-1,Cav-1 ELISA KIT	96 Test	38220090	24,500.00
CLS0104HU	Human Cathepsin L,Cath-L ELISA Kit	96 Test	38220090	24,500.00
CLS0105HU	Human cathepsin antibody,cath-Ab ELISA Kit	96 Test	38220090	24,500.00
CLS0106HU	Human Catenin Beta 1 (CTNNb1)ELISA Kit	96 Test	38220090	24,500.00
CLS0107HU	Human Catalase (CAT)ELISA Kit	96 Test	38220090	24,500.00
CLS0108HU	Human Caspase cleaved cytokeratin-18(CCCK-18)ELISA Kit	96 Test	38220090	24,500.00
CLS0109HU	Human Caspase 8 (CASP8)ELISA kit	96 Test	38220090	24,500.00
CLS0110HU	Human Caspase 1 (CASP1)ELISA kit	96 Test	38220090	24,500.00
CLS0111HU	Human cartilage oligomeric protein,COMP ELISA Kit	96 Test	38220090	24,500.00
CLS0112HU	Human cartilage oligomeric matrix protein,COMP ELISA Kit	96 Test	38220090	24,500.00
CLS0113HU	Human Carnitine Transporter 2 (CT2)ELISA Kit	96 Test	38220090	24,500.00
CLS0114HU	Human cardiotrophin 1,CT-1 ELISA Kit	96 Test	38220090	24,500.00
CLS0115HU	Human cardiac troponin I ,cTn- I ELISA Kit	96 Test	38220090	24,500.00
CLS0116HU	Human Cardiac myosin-light chains 1,CMLC-1 ELISA Kit	96 Test	38220090	24,500.00
CLS0117HU	Human Carboxyterminal propeptide of type II procollagen,P II CP ELISA Kit	96 Test	38220090	24,500.00
CLS0118HU	Human Carboxyterminal propeptide of type III procollagen,P III CP ELISA Kit	96 Test	38220090	24,500.00
CLS0119HU	Human Carboxyterminal propeptide of type I procollagen,P I CP ELISA Kit	96 Test	38220090	24,500.00
CLS0120HU	Human Carboxymethyl lysine,CML ELISA Kit	96 Test	38220090	24,500.00
CLS0121HU	Human carbonic anhydrase1,CA1 ELISA Kit	96 Test	38220090	24,500.00
CLS0122HU	Human Carbonic Anhydrase VI (CA6)ELISA kit	96 Test	38220090	24,500.00
CLS0123HU	Human Carbonic Anhydrase III, Muscle Specific (CA3)ELISA kit	96 Test	38220090	24,500.00
CLS0124HU	Human carbonic anhydrase 2,CA-2 ELISA Kit	96 Test	38220090	24,500.00
CLS0125HU	Human carbohydrate antigen724, CA724 ELISA Kit	96 Test	38220090	24,500.00
CLS0126HU	Human Carbohydrate Antigen 125 (CA125)ELISA kit	96 Test	38220090	24,500.00
CLS0127HU	Human Carbohydrate Antigen 50(CA50)ELISA Kit	96 Test	38220090	24,500.00
CLS0128HU	Human Calreticulin,CRT ELISA Kit	96 Test	38220090	24,500.00
CLS0129HU	Human Calpastatin/Calpain inhibitor,CAST ELISA Kit	96 Test	38220090	24,500.00
CLS0130HU	Human Campylobacter Jejuni,PEB1 ELISA Kit	96 Test	38220090	24,500.00
CLS0131HU	Human Collagenase I(CLG1)ELISA Kit	96 Test	38220090	24,500.00
CLS0132HU	Human Collagen, type III, alpha 1,COL3A1 ELISA Kit	96 Test	38220090	24,500.00
CLS0133HU	Human Collagen Type IV,Col IV ELISA Kit	96 Test	38220090	24,500.00

Cat.No.	Product Description	Pack Size	HSN	Unit Price
CLS0134HU	Human Collagen Type III,Col III ELISA KIT	96 Test	38220090	24,500.00
CLS0135HU	Human Collagen Type II,Col II ELISA Kit	96 Test	38220090	24,500.00
CLS0136HU	Human Collagen alpha-1(XVIII) chain,COL18A1 ELISA kit	96 Test	38220090	24,500.00
CLS0137HU	Human Coll2-1(Coll2-1)ELISA Kit	96 Test	38220090	24,500.00
CLS0138HU	Human Coenzyme Q10 (CoQ10)ELISA Kit	96 Test	38220090	24,500.00
CLS0139HU	Human coagulation factor X III,F X III ELISA Kit	96 Test	38220090	24,500.00
CLS0140HU	Human coagulation factor II,F II ELISA Kit	96 Test	38220090	24,500.00
CLS0141HU	Human cluster Of differentiation,CD4 ELISA Kit	96 Test	38220090	24,500.00
CLS0142HU	Human cluster Of differentiation,CD14 ELISA Kit	96 Test	38220090	24,500.00
CLS0143HU	Human cluster Of differentiation,CD44 ELISA Kit	96 Test	38220090	24,500.00
CLS0144HU	Human cluster of differentiation 146,sCD146 ELISA Kit	96 Test	38220090	24,500.00
CLS0145HU	Human Cluster of differentiation 19,CD19 ELISA Kit	96 Test	38220090	24,500.00
CLS0146HU	Human Claudin 5 (CLDN5)ELISA kit	96 Test	38220090	24,500.00
CLS0147HU	Human Claudin 3 (CLDN3)ELISA kit	96 Test	38220090	24,500.00
CLS0148HU	Human Clara cell protein,CC16 ELISA Kit	96 Test	38220090	24,500.00
CLS0149HU	Human Chymase 1, Mast Cell (CMA1)ELISA Kit	96 Test	38220090	24,500.00
CLS0150HU	Human Chromosome 19 open reading frame 80 (C19orf80) ELISA kit	96 Test	38220090	24,500.00
CLS0151HU	Human Chromogranin-A,CgA ELISA Kit	96 Test	38220090	24,500.00
CLS0152HU	Human Chorionic Gonadotrophin,HCG ELISA Kit	96 Test	38220090	24,500.00
CLS0153HU	Human corticotropin-releasing factor,CRF ELISA Kit	96 Test	38220090	24,500.00
CLS0154HU	Human Corticosterone,CORT ELISA Kit	96 Test	38220090	24,500.00
CLS0155HU	Human concanavalin A,ConA ELISA Kit	96 Test	38220090	24,500.00
CLS0156HU	Human complex edprostate specific antigen,cPSA ELISA Kit	96 Test	38220090	24,500.00
CLS0157HU	Human Complement fragment 4a,C4a ELISA Kit	96 Test	38220090	24,500.00
CLS0158HU	Human Complement fragment 3b,C3b ELISA Kit	96 Test	38220090	24,500.00
CLS0159HU	Human Complement fragment 3a,C3a ELISA Kit	96 Test	38220090	24,500.00
CLS0160HU	Human complement factor H precursor,pre-CFH ELISA Kit	96 Test	38220090	24,500.00
CLS0161HU	Human Complement factor D/Adipsin,CFD ELISA Kit	96 Test	38220090	24,500.00
CLS0162HU	Human complement factor B precursor,pre-CFB ELISA Kit	96 Test	38220090	24,500.00
CLS0163HU	Human Complement C1q tumor necrosis factor related protein 5,C1qtnf5/Ctrp5 ELISA Kit	96 Test	38220090	24,500.00
CLS0164HU	Human Complement 1q,C1q ELISA Kit	96 Test	38220090	24,500.00
CLS0165HU	Human Complement 1 inhibitor,C1INH ELISA Kit	96 Test	38220090	24,500.00
CLS0166HU	Human colon cancer-specific antigen-2,CCSA-2 ELISA kit	96 Test	38220090	24,500.00
CLS0167HU	Human Creatine Kinase MB isoenzyme,CK-MB ELISA Kit	96 Test	38220090	24,500.00
CLS0168HU	Human creatine kinase BB isoenzymes · CK-BB ELISA Kit	96 Test	38220090	24,500.00
CLS0169HU	Human Cortisol(COR) ELISA Kit	96 Test	38220090	24,500.00
CLS0170HU	Human fibroblast growth factor-20,FGF-20 ELISA Kit	96 Test	38220090	24,500.00
CLS0171HU	Human fibrinopeptide B,FPB ELISA Kit	96 Test	38220090	24,500.00
CLS0172HU	Human fibrinopeptide A,FPA ELISA Kit	96 Test	38220090	24,500.00
CLS0173HU	Human Fibrinogen,Fbg ELISA Kit	96 Test	38220090	24,500.00
CLS0174HU	Human Fibrinogen Degradation Product,FDP ELISA Kit	96 Test	38220090	24,500.00
CLS0175HU	Human Fibrillin-1,FBN1 ELISA Kit	96 Test	38220090	24,500.00
CLS0176HU	Human fetal hemoglobin,HBf ELISA Kit	96 Test	38220090	24,500.00
CLS0177HU	Human ferritin,FE ELISA Kit	96 Test	38220090	24,500.00
CLS0178HU	Human Estrogen Receptor,ER ELISA Kit	96 Test	38220090	24,500.00
CLS0179HU	Human Estrogen Receptor beta,ER-beta ELISA Kit	96 Test	38220090	24,500.00
CLS0180HU	Human Estrogen Receptor Alpha,ERa ELISA Kit	96 Test	38220090	24,500.00
CLS0181HU	Human Estradiol,E2 ELISA Kit	96 Test	38220090	24,500.00
CLS0182HU	Human Estradiol 17-beta-dehydrogenase 1,HSD17B1 ELISA Kit	96 Test	38220090	24,500.00
CLS0183HU	Human Erythropoietin,EPO ELISA Kit	96 Test	38220090	24,500.00
CLS0184HU	Human Erythropoietin receptor,EPOR ELISA Kit	96 Test	38220090	24,500.00
CLS0185HU	Human Erythropoietin antibody,EPO-antibody ELISA Kit	96 Test	38220090	24,500.00
CLS0186HU	Human erythropoiesis stimulating factor,ESF ELISA Kit	96 Test	38220090	24,500.00

Cat.No.	Product Description	Pack Size	HSN	Unit Price
CLS0187HU	Human Erythrocyte Protoporphyrin (EP)ELISA Kit	96 Test	38220090	24,500.00
CLS0188HU	Human epiligrin,EP ELISA Kit	96 Test	38220090	24,500.00
CLS0189HU	Human Epididymal protein 4,HE4 ELISA Kit	96 Test	38220090	24,500.00
CLS0190HU	Human epidermal Fatty acid binding protein 5,eFABP5 ELISA kit	96 Test	38220090	24,500.00
CLS0191HU	Human eosinophil cationic protein,ECP ELISA Kit	96 Test	38220090	24,500.00
CLS0192HU	Human Enhancer Of Zeste Homolog 2 (EZH2)ELISA Kit	96 Test	38220090	24,500.00
CLS0193HU	Human Endothelin-converting enzyme 1,ECE1 ELISA Kit	96 Test	38220090	24,500.00
CLS0194HU	Human Growth Differentiation Factor 11 (GDF11)ELISA kit	96 Test	38220090	24,500.00
CLS0195HU	Human Gremlin 1 (GREM1)ELISA Kit	96 Test	38220090	24,500.00
CLS0196HU	Human granulysin,GNLY ELISA Kit	96 Test	38220090	24,500.00
CLS0197HU	Human Granulocyte-Macrophage Colony Stimulating Factor,GM-CSF ELISA Kit	96 Test	38220090	24,500.00
CLS0198HU	Human G-protein coupled receptor kinase 2,GRK2 ELISA Kit	96 Test	38220090	24,500.00
CLS0199HU	Human Golgi Phosphoprotein 3 (GOLPH3)ELISA Kit	96 Test	38220090	24,500.00
CLS0200HU	Human GM2 Ganglioside Activator (GM2A)ELISA Kit	96 Test	38220090	24,500.00
CLS0201HU	Human Glypican-3,GPC-3 ELISA Kit	96 Test	38220090	24,500.00
CLS0202HU	Human Glypican 4 (GPC4)ELISA Kit	96 Test	38220090	24,500.00
CLS0203HU	Human Glypican 1 (GPC1)ELISA Kit	96 Test	38220090	24,500.00
CLS0204HU	Human glycosylated serum protein,GSP ELISA Kit	96 Test	38220090	24,500.00
CLS0205HU	human glycoprotein 49A,Gp49a ELISA Kit	96 Test	38220090	24,500.00
CLS0206HU	Human glycogen synthase kinase,GSK ELISA Kit	96 Test	38220090	24,500.00
CLS0207HU	Human glyceraldehyde-3-phosphate dehydrogenase,GAPDH ELISA Kit	96 Test	38220090	24,500.00
CLS0208HU	Human Glutathione peroxidase,GSH-Px ELISA Kit	96 Test	38220090	24,500.00
CLS0209HU	Human Glutamate dehydrogenase;GDH/GLDH ELISA Kit	96 Test	38220090	24,500.00
CLS0210HU	Human Glucose-6-phosphate 1-dehydrogenase(G6PD)ELISA kit	96 Test	38220090	24,500.00
CLS0211HU	Human Glucagon-like peptide 1,GLP-1 ELISA Kit	96 Test	38220090	24,500.00
CLS0212HU	Human Gliadin IGA(GI-IGA)ELISA Kit	96 Test	38220090	24,500.00
CLS0213HU	Human Ghrelin receptor,GR/GHSR ELISA Kit	96 Test	38220090	24,500.00
CLS0214HU	Human Gelsolin,GS ELISA Kit	96 Test	38220090	24,500.00
CLS0215HU	Human gamma glutamyl transpeptidase,GGT ELISA Kit	96 Test	38220090	24,500.00
CLS0216HU	Human Galectin-3(Galectin-3)ELISA Kit	96 Test	38220090	24,500.00
CLS0217HU	Human Galactomannan(GM)ELISA Kit	96 Test	38220090	24,500.00
CLS0218HU	Human G1/S-specific Cyclin-D1,Cyclin-D1 ELISA Kit	96 Test	38220090	24,500.00
CLS0219HU	Human G protein-activated inward rectifier potassium channel 1,KCNJ3/GIRK1 ELISA Kit	96 Test	38220090	24,500.00
CLS0220HU	Human G Protein Coupled Receptor 120 (GPR120)ELISA Kit	96 Test	38220090	24,500.00
CLS0221HU	Human Frizzled Homolog 4 (FZD4)ELISA Kit	96 Test	38220090	24,500.00
CLS0222HU	Human Free Tri-iodothyronine Indes,Free-T3 ELISA Kit	96 Test	38220090	24,500.00
CLS0223HU	Human Free Thyroxine,FT4 ELISA Kit	96 Test	38220090	24,500.00
CLS0224HU	Human free fatty acids,FFA ELISA Kit	96 Test	38220090	24,500.00
CLS0225HU	Human free cholesterol,fCHOL ELISA kit	96 Test	38220090	24,500.00
CLS0226HU	Human Free carnitine (F-C) ELISA kit	96 Test	38220090	24,500.00
CLS0227HU	Human formylmethionine,fMet ELISA Kit	96 Test	38220090	24,500.00
CLS0228HU	Human forkhead box P3,Foxp3 ELISA Kit	96 Test	38220090	24,500.00
CLS0229HU	Human forkhead box O3,FOXO3 ELISA Kit	96 Test	38220090	24,500.00
CLS0230HU	Human forkhead box O1,FOXO1 ELISA Kit	96 Test	38220090	24,500.00
CLS0231HU	Human follicle-stimulating hormone,FSH ELISA Kit	96 Test	38220090	24,500.00
CLS0232HU	Human Folic acid polyglutamate (FPGS)ELISA Kit	96 Test	38220090	24,500.00
CLS0233HU	Human FMS-like tyrosine kinase 3,Flt3 ELISA Kit	96 Test	38220090	24,500.00
CLS0234HU	Human ficolin 2,FCN2 ELISA Kit	96 Test	38220090	24,500.00
CLS0235HU	Human Fibulin5,FBLN5 ELISA Kit	96 Test	38220090	24,500.00
CLS0236HU	Human Fibulin2,FBLN2 ELISA Kit	96 Test	38220090	24,500.00
CLS0237HU	Human Fibronectin,FN ELISA Kit	96 Test	38220090	24,500.00

Cat.No.	Product Description	Pack Size	HSN	Unit Price
CLS0238HU	Human fibroblast growth factor-21,FGF-21 ELISA Kit	96 Test	38220090	24,500.00
CLS0239HU	Human H-ras(H-ras)ELISA Kit	96 Test	38220090	24,500.00
CLS0240HU	Human Hemopexin,HPX ELISA kit	96 Test	38220090	24,500.00
CLS0241HU	Human Hemojuvelin (HJV)ELISA Kit	96 Test	38220090	24,500.00
CLS0242HU	Human Heat Shock Protein 90kDa Alpha A1 (HSP90aA1)ELISA kit	96 Test	38220090	24,500.00
CLS0243HU	Human Heat Shock Protein 65(HSP-65)ELISA Kit	96 Test	38220090	24,500.00
CLS0244HU	Human Heat Shock 70kDa Protein 1 Like Protein (HSPA1L)ELISA kit	96 Test	38220090	24,500.00
CLS0245HU	Human Heat Shock 10kDa Protein 1 (HSP10)ELISA kit	96 Test	38220090	24,500.00
CLS0246HU	Human H-Cadherin,H-Cad/CDH13 ELISA Kit	96 Test	38220090	24,500.00
CLS0247HU	Human Haptoglobin,Hpt/HP ELISA KIT	96 Test	38220090	24,500.00
CLS0248HU	Human Guanine nucleotide exchange factor VAV3,VAV3 ELISA Kit	96 Test	38220090	24,500.00
CLS0249HU	Human growth hormone releasing peptide-Ghrelin,GHRP-Ghrelin ELISA Kit	96 Test	38220090	24,500.00
CLS0250HU	Human growth differentiation factor 15,GDF15 ELISA Kit	96 Test	38220090	24,500.00
CLS0251HU	Human growth differentiation factor 2,GDF2 ELISA Kit	96 Test	38220090	24,500.00
CLS0252HU	Human Hepcidin-25(HEPC25) ELISA Kit	96 Test	38220090	24,500.00
CLS0253HU	human Hepcidin,Hepc ELISA Kit	96 Test	38220090	24,500.00
CLS0254HU	human Hepcidin Prohormone/Pro-Hepcidin,Pro-Hepc ELISA Kit	96 Test	38220090	24,500.00
CLS0255HU	Human heparin cofactor II,HC II ELISA Kit	96 Test	38220090	24,500.00
CLS0256HU	Human Heparanase,HPA ELISA kit	96 Test	38220090	24,500.00
CLS0257HU	Human oxidized lowdensity lipoprotein,OxLDL ELISA Kit	96 Test	38220090	24,500.00
CLS0258HU	Human killer cell immnoglobulin-like receptor,KIR ELISA Kit	96 Test	38220090	24,500.00
CLS0259HU	Human Keratinocyte Growth Factor,KGF ELISA Kit	96 Test	38220090	24,500.00
CLS0260HU	Human keratan sulfate,KS ELISA Kit	96 Test	38220090	24,500.00
CLS0261HU	Human Kallikrein 7,KLK7 ELISA Kit	96 Test	38220090	24,500.00
CLS0262HU	Human Kallikrein 8,KLK8 ELISA Kit	96 Test	38220090	24,500.00
CLS0263HU	Human Kallikrein 5,KLK5 ELISA Kit	96 Test	38220090	24,500.00
CLS0264HU	Human Kallikrein 4,KLK4 ELISA Kit	96 Test	38220090	24,500.00
CLS0265HU	Human Kallikrein 1,KLK1 ELISA Kit	96 Test	38220090	24,500.00
CLS0266HU	Human Isocitrate dehydrogenase [NADP] mitochondrial(IDH2) ELISA Kit	96 Test	38220090	24,500.00
CLS0267HU	Human Isocitrate dehydrogenase [NADP] cytoplasmic(IDH1) ELISA Kit	96 Test	38220090	24,500.00
CLS0268HU	Human IPO-38(IPO-38)ELISA Kit	96 Test	38220090	24,500.00
CLS0269HU	Human Inward rectifier potassium channel 16,KCNJ16 ELISA Kit	96 Test	38220090	24,500.00
CLS0270HU	Human Interleukin-1 Family Member 10(IL1F10)ELISA Kit	96 Test	38220090	24,500.00
CLS0271HU	Human Interleukin 38,IL-38 ELISA Kit	96 Test	38220090	24,500.00
CLS0272HU	Human Interleukin 37,IL-37 ELISA KIT	96 Test	38220090	24,500.00
CLS0273HU	Human Interleukin 31,IL-31 ELISA Kit	96 Test	38220090	24,500.00
CLS0274HU	Human Interleukin 4 receptor,IL4R/CD124 ELISA Kit	96 Test	38220090	24,500.00
CLS0275HU	Human Interleukin 4 Induced Protein 1 (IL4I1)ELISA Kit	96 Test	38220090	24,500.00
CLS0276HU	Human low density lipoprotein,LDL ELISA Kit	96 Test	38220090	24,500.00
CLS0277HU	Human Low Density Lipoprotein Receptor Related Protein 5(LRP5)ELISA Kit	96 Test	38220090	24,500.00
CLS0278HU	Human L-Lactate Dehydrogenase,L-LDH ELISA Kit	96 Test	38220090	24,500.00
CLS0279HU	Human Liver X receptor alpha,LXR-alpha ELISA Kit	96 Test	38220090	24,500.00
CLS0280HU	Human lipoteichoic acids,LTA ELISA Kit	96 Test	38220090	24,500.00
CLS0281HU	Human lipoprotein-associated phospholipase A2,Lp-PLA2 ELISA Kit	96 Test	38220090	24,500.00
CLS0282HU	Human lipopolysaccharide binding protein,LBP ELISA Kit	96 Test	38220090	24,500.00
CLS0283HU	Human Lipocalin 6 (LCN6)ELISA Kit	96 Test	38220090	24,500.00
CLS0284HU	Human Lipoarabinomannan,LAM ELISA Kit	96 Test	38220090	24,500.00
CLS0285HU	Human lipid -bound sialic acid,LSA ELISA Kit	96 Test	38220090	24,500.00
CLS0286HU	Human linolenic acid(LA) ELISA Kit	96 Test	38220090	24,500.00

Cat.No.	Product Description	Pack Size	HSN	Unit Price
CLS0287HU	Human leukotriene D4,LT-D4 ELISA Kit	96 Test	38220090	24,500.00
CLS0288HU	Human Leukotriene C4,LT-C4 ELISA Kit	96 Test	38220090	24,500.00
CLS0289HU	Human Leukotriene B4,LT-B4 ELISA Kit	96 Test	38220090	24,500.00
CLS0290HU	Human Leukotriene B4 receptor 2,LTB4R2 ELISA Kit	96 Test	38220090	24,500.00
CLS0291HU	Human leukocyte common antigen,LCA/CD45 ELISA Kit	96 Test	38220090	24,500.00
CLS0292HU	Human Leukocyte Cell Derived Chemotaxin 1 (LECT1)ELISA kit	96 Test	38220090	24,500.00
CLS0293HU	Human Leukocyte Associated Immunoglobulin Like Receptor 2 (LAIR2)ELISA kit	96 Test	38220090	24,500.00
CLS0294HU	Human Leukemia inhibitory factor,LIF ELISA kit	96 Test	38220090	24,500.00
CLS0295HU	Human leukemia inhibitory factor receptor,LIFR ELISA Kit	96 Test	38220090	24,500.00
CLS0296HU	Human leucine-rich alpha-2 glycoprotein 1,LRG1 ELISA Kit	96 Test	38220090	24,500.00
CLS0297HU	Human Leucine aminopeptidase,LAP ELISA Kit	96 Test	38220090	24,500.00
CLS0298HU	Human Leptin Receptor,LEPR ELISA Kit	96 Test	38220090	24,500.00
CLS0299HU	Human Leiomodin 1 (LMOD1)ELISA Kit	96 Test	38220090	24,500.00
CLS0300HU	Human Large Multifunctional Peptidase 7 (LMP7)ELISA Kit	96 Test	38220090	24,500.00
CLS0301HU	Human Klotho Beta (KLb)ELISA Kit	96 Test	38220090	24,500.00
CLS0302HU	Human Kisspeptin 1(KISS-1) ELISA Kit	96 Test	38220090	24,500.00
CLS0303HU	Human Kininogen-1,KN1G1/HMWK ELISA Kit	96 Test	38220090	24,500.00
CLS0304HU	Human Kinesin Family, Member 18A (KIF18A)ELISA Kit	96 Test	38220090	24,500.00
CLS0305HU	Human macrophage chemotactic factor,MCF ELISA Kit	96 Test	38220090	24,500.00
CLS0306HU	Human macrophage activating factor,MAF ELISA Kit	96 Test	38220090	24,500.00
CLS0307HU	Human Lysyl oxidase-like protein 1,LOXL1 ELISA kit	96 Test	38220090	24,500.00
CLS0308HU	Human lysosomal-associated membrane protein 2,HLAMP-2 ELISA Kit	96 Test	38220090	24,500.00
CLS0309HU	Human lymphocyte function associated antigen 1,LFA-1 ELISA Kit	96 Test	38220090	24,500.00
CLS0310HU	Human Motilin,MTL ELISA Kit	96 Test	38220090	24,500.00
CLS0311HU	Human Mothers Against Decapentaplegic Homolog 2 (Smad2)ELISA Kit	96 Test	38220090	24,500.00
CLS0312HU	Human Mothers against decapentaplegic homolog 1,Smad1 ELISA Kit	96 Test	38220090	24,500.00
CLS0313HU	Human monokine induced by interferon-gamma,MIG/CXCL9 ELISA Ki	96 Test	38220090	24,500.00
CLS0314HU	Human monoamine oxidase,MAO ELISA Kit	96 Test	38220090	24,500.00
CLS0315HU	Human Mixed Lymphocyte Reaction Blocking Factor (MLR-Bf) ELISA kit	96 Test	38220090	24,500.00
CLS0316HU	Human mid-regional pro-adrenomedullin,MR-ProADM ELISA Kit	96 Test	38220090	24,500.00
CLS0317HU	Human microtransferrinuria,MTF ELISA Kit	96 Test	38220090	24,500.00
CLS0318HU	Human microalbuminuria,MAU/ALB ELISA Kit	96 Test	38220090	24,500.00
CLS0319HU	Human metanephrine,MN ELISA Kit	96 Test	38220090	24,500.00
CLS0320HU	Human Metallothionein 2,MT2 ELISA Kit	96 Test	38220090	24,500.00
CLS0321HU	Human Melatonin,MT ELISA Kit	96 Test	38220090	24,500.00
CLS0322HU	Human Melanotransferrin (MFI2)ELISA Kit	96 Test	38220090	24,500.00
CLS0323HU	Human melanocyte stimulating hormone Alpha(Alpha-MSH)ELISA Kit	96 Test	38220090	24,500.00
CLS0324HU	Human maturation promoting factor,MF/MPF ELISA Kit	96 Test	38220090	24,500.00
CLS0325HU	Human Matrix metalloproteinase 13,MMP-13 ELISA kit	96 Test	38220090	24,500.00
CLS0326HU	Human matrix metalloproteinase 12,MMP-12 ELISA kit	96 Test	38220090	24,500.00
CLS0327HU	Human matrix metalloproteinase 11,MMP-11 ELISA Kit	96 Test	38220090	24,500.00
CLS0328HU	Human Matrix metalloproteinase 8/Neutrophil collagenase,MMP-8 ELISA kit	96 Test	38220090	24,500.00
CLS0329HU	Human Matrix metalloproteinase 3,MMP-3 ELISA kit	96 Test	38220090	24,500.00
CLS0330HU	Human Matrix metalloproteinase 1,MMP-1 ELISA kit	96 Test	38220090	24,500.00
CLS0331HU	Human matrix extracellular phosphoglycoprotein,MEPE ELISA Kit	96 Test	38220090	24,500.00
CLS0332HU	Human mast cell tryptase,MCT ELISA Kit	96 Test	38220090	24,500.00

Cat.No.	Product Description	Pack Size	HSN	Unit Price
CLS0333HU	Human Mannose Associated Serine Protease 1 (MASP1)ELISA Kit	96 Test	38220090	24,500.00
CLS0334HU	Human Mannma binding lectin receptor,MBLR ELISA Kit	96 Test	38220090	24,500.00
CLS0335HU	Human malondialchehyche,MDA ELISA Kit	96 Test	38220090	24,500.00
CLS0336HU	Human Macrophage-Derived Chemokine,MDC ELISA kit	96 Test	38220090	24,500.00
CLS0337HU	Human Macrophage Migration Inhibitory Factor,MIF ELISA Kit	96 Test	38220090	24,500.00
CLS0338HU	Human Macrophage Inflammatory Protein-1 β ,MIP-1 β ELISA kit	96 Test	38220090	24,500.00
CLS0339HU	Human macrophage inflammatory protein 5,MIP-5 ELISA Kit	96 Test	38220090	24,500.00
CLS0340HU	Human macrophage inflammatory protein 2,MIP-2 ELISA Kit	96 Test	38220090	24,500.00
CLS0341HU	Human Osteoprotegerin Ligand,OPGL ELISA Kit	96 Test	38220090	24,500.00
CLS0342HU	Human Osteopontin,OPN ELISA Kit	96 Test	38220090	24,500.00
CLS0343HU	Human Ornithine decarboxylase,ODC1 ELISA Kit	96 Test	38220090	24,500.00
CLS0344HU	Human Opsin 5 (OPN5)ELISA Kit	96 Test	38220090	24,500.00
CLS0345HU	Human Opioid Peptide (OP)ELISA kit	96 Test	38220090	24,500.00
CLS0346HU	Human Intelectin-1,ITLN1/Omentin ELISA Kit	96 Test	38220090	24,500.00
CLS0347HU	Human oligodendrocyte transcription factor 1,Olig1 ELISA kit	96 Test	38220090	24,500.00
CLS0348HU	Human Oleic Acid(OA) ELISA Kit	96 Test	38220090	24,500.00
CLS0349HU	Human Octamer binding transcription factor 4(OCT4) ELISA ELISA	96 Test	38220090	24,500.00
CLS0350HU	Human Phospholipase C,PLC ELISA Kit	96 Test	38220090	24,500.00
CLS0351HU	Human Phospholipase A2, Group IIA (PLA2G2A)ELISA kit	96 Test	38220090	24,500.00
CLS0352HU	Human Phospholipase A1 (PLA1)ELISA kit	96 Test	38220090	24,500.00
CLS0353HU	Human Phosphoglucomutase 1 (PGM1)ELISA kit	96 Test	38220090	24,500.00
CLS0354HU	Human phospho-extracellular signal-regulated kinase,pERK ELISA Kit	96 Test	38220090	24,500.00
CLS0355HU	Human phospho Tau Protein,pr ELISA kit	96 Test	38220090	24,500.00
CLS0356HU	Human phosphatidylserine receptor,PSR ELISA Kit	96 Test	38220090	24,500.00
CLS0357HU	Human Peroxisome Proliferator-activated receptor gamma,PPAR-gamma ELISA Kit	96 Test	38220090	24,500.00
CLS0358HU	Human Peroxiredoxin 6 (PRDX6)ELISA Kit	96 Test	38220090	24,500.00
CLS0359HU	Human Peptidoglycan Recognition protein 2(PGLYRP2)ELISA Kit	96 Test	38220090	24,500.00
CLS0360HU	human Pepsinogen A,PG-A ELISA Kit	96 Test	38220090	24,500.00
CLS0361HU	Human Pentraxin 3 ,PTX3 ELISA Kit	96 Test	38220090	24,500.00
CLS0362HU	Human parathyroid hormone-like protein,PLP ELISA Kit	96 Test	38220090	24,500.00
CLS0363HU	human Parathyroid hormone,PTH ELISA Kit	96 Test	38220090	24,500.00
CLS0364HU	Human paraoxonase,PON ELISA Kit	96 Test	38220090	24,500.00
CLS0365HU	Human Pancreastatin(Pancreastatin)ELISA Kit	96 Test	38220090	24,500.00
CLS0366HU	Human p53/tumor protein,p53/TP53 ELISA Kit	96 Test	38220090	24,500.00
CLS0367HU	Human p16 ELISA Kit	96 Test	38220090	24,500.00
CLS0368HU	Human Oxysterol-binding protein-related protein 3,OSBPL3 ELISA Kit	96 Test	38220090	24,500.00
CLS0369HU	Human Oxysterol-binding protein 2,OSBP2 ELISA Kit	96 Test	38220090	24,500.00
CLS0370HU	Human Oxysterol Binding Protein Like Protein 11,OSBPL11 ELISA Kit	96 Test	38220090	24,500.00
CLS0371HU	Human Oxysterol Binding Protein Like Protein 10,OSBPL10 ELISA Kit	96 Test	38220090	24,500.00
CLS0372HU	Human Oxysterol Binding Protein Like Protein 9,OSBPL9 ELISA Kit	96 Test	38220090	24,500.00
CLS0373HU	Human Oxysterol Binding Protein Like Protein 7,OSBPL7 ELISA Kit	96 Test	38220090	24,500.00
CLS0374HU	Human Oxysterol Binding Protein Like Protein 6,OSBPL6 ELISA Kit	96 Test	38220090	24,500.00
CLS0375HU	Human Oxysterol Binding Protein Like Protein 5,OSBPL5 ELISA Kit	96 Test	38220090	24,500.00

Cat.No.	Product Description	Pack Size	HSN	Unit Price
CLS0376HU	Human Oxysterol Binding Protein Like Protein 2,OSBPL2 ELISA Kit	96 Test	38220090	24,500.00
CLS0377HU	Human oxidized lowdensity lipoprotein antibody,OLAb ELISA Kit	96 Test	38220090	24,500.00
CLS0378HU	Human oxalic acid ,OA ELISA Kit	96 Test	38220090	24,500.00
CLS0379HU	Human ovalbumin specific IgG1,OVA sIgG1 ELISA Kit	96 Test	38220090	24,500.00
CLS0380HU	Human ovalbumin specific IgG,OVA sIgG ELISA Kit	96 Test	38220090	24,500.00
CLS0381HU	Human ovalbumin specific IgE,OVA sIgE ELISA Kit	96 Test	38220090	24,500.00
CLS0382HU	Human Protease Activated Receptor 1(PAR1) ELISA Kit	96 Test	38220090	24,500.00
CLS0383HU	Human Protamine 1,PRM1 ELISA Kit	96 Test	38220090	24,500.00
CLS0384HU	Human Protachykinin-1 (TAC1)ELISA Kit	96 Test	38220090	24,500.00
CLS0385HU	Human prostaglandin G/H synthase 2(PTGS2)ELISA Kit	96 Test	38220090	24,500.00
CLS0386HU	Human Prostaglandin E2,PG-E2 ELISA Kit	96 Test	38220090	24,500.00
CLS0387HU	human Prostaglandin E1,PG-E1 ELISA Kit	96 Test	38220090	24,500.00
CLS0388HU	Human prostacycline,PGI2 ELISA Kit	96 Test	38220090	24,500.00
CLS0389HU	Human Proprotein Convertase Subtilisin/Kexin Type 9 (PCSK9)ELISA kit	96 Test	38220090	24,500.00
CLS0390HU	Human Proline dipeptidase,PEPD ELISA Kit	96 Test	38220090	24,500.00
CLS0391HU	Human pro-islet amyloid polypeptide/Pro-amylin,proIAPP ELISA Kit	96 Test	38220090	24,500.00
CLS0392HU	Human Proinsulin,PI ELISA Kit	96 Test	38220090	24,500.00
CLS0393HU	Human Progranulin(PGRN) ELISA Kit	96 Test	38220090	24,500.00
CLS0394HU	Human Programmed Death 1 (PD-1)ELISA Kit	96 Test	38220090	24,500.00
CLS0395HU	Human Programmed cell death protein 1,PDCD1 ELISA Kit	96 Test	38220090	24,500.00
CLS0396HU	Human Programed Death Ligand-1,PDL1/B7-H1/CD274 ELISA Kit	96 Test	38220090	24,500.00
CLS0397HU	Human progesterone receptor,PGR ELISA Kit	96 Test	38220090	24,500.00
CLS0398HU	Human Proenkephalin (PENK)ELISA kit	96 Test	38220090	24,500.00
CLS0399HU	Human Procollagen II C-terminal peptide(PIICP)ELISA Kit	96 Test	38220090	24,500.00
CLS0400HU	Human procollagen I N-terminal peptide,P I NP ELISA Kit	96 Test	38220090	24,500.00
CLS0401HU	Human Procalcitonin,PCT ELISA Kit	96 Test	38220090	24,500.00
CLS0402HU	Human Proadrenomedullin ,Pro-ADM ELISA Kit	96 Test	38220090	24,500.00
CLS0403HU	Human Pro Atrial Natriuretic Peptide,Pro-ANP ELISA Kit	96 Test	38220090	24,500.00
CLS0404HU	Human Potassium channel subfamily K member 9,KCNK9 ELISA Kit	96 Test	38220090	24,500.00
CLS0405HU	Human polymeric immunoglobulin receptor/secretory component,PIGR/SC ELISA Kit	96 Test	38220090	24,500.00
CLS0406HU	Human podocin(PDCN) ELISA Kit	96 Test	38220090	24,500.00
CLS0407HU	Human pleiotrophin,PTN ELISA Kit	96 Test	38220090	24,500.00
CLS0408HU	Human Platelet Factor 4,PF-4 ELISA Kit	96 Test	38220090	24,500.00
CLS0409HU	Human placenta protein13,PP13 Elisa Kit	96 Test	38220090	24,500.00
CLS0410HU	Human placenta growth factor,PLGF ELISA kit	96 Test	38220090	24,500.00
CLS0411HU	Human pituitary adenylate cyclase activating polypeptide,PACAP ELISA Kit	96 Test	38220090	24,500.00
CLS0412HU	Human pigment epithelium-derived factor,PEDF ELISA Kit	96 Test	38220090	24,500.00
CLS0413HU	Human Pigment epithelium-derived factor precursor,Pre-PEDF ELISA kit	96 Test	38220090	24,500.00
CLS0414HU	Human Phosphorylated adenosine monophosphate activated protein kinase,AMPK ELISA ki	96 Test	38220090	24,500.00
CLS0415HU	Human Phospholipidase A2,PL-A2 ELISA Kit	96 Test	38220090	24,500.00
CLS0416HU	Human Phospholipase D4 (PLD4)ELISA Kit	96 Test	38220090	24,500.00
CLS0417HU	Human Phospholipase D3 (PLD3)ELISA Kit	96 Test	38220090	24,500.00
CLS0418HU	Human Sonic Hedgehog Homolog(SHH)ELISA Kit	96 Test	38220090	24,500.00
CLS0419HU	Human soluble tumor necrosis factor receptor 2,sTNF-R2 ELISA Kit	96 Test	38220090	24,500.00
CLS0420HU	Human soluble Triggering Receptor Expresses on Myeloid Cells-1,sTREM-1 ELISA Kit	96 Test	38220090	24,500.00

Cat.No.	Product Description	Pack Size	HSN	Unit Price
CLS0421HU	Human soluble protein 185,sp185/HER-2 ELISA Kit	96 Test	38220090	24,500.00
CLS0422HU	Human soluble platelet endothelial cell adhesion molecule 1,sPECAM-1 ELISA Kit	96 Test	38220090	24,500.00
CLS0423HU	Human soluble Phospholipase A2,sPL-A2 ELISA Kit	96 Test	38220090	24,500.00
CLS0424HU	Human Soluble Mesothelin Related Peptide,SMRP ELISA Kit	96 Test	38220090	24,500.00
CLS0425HU	Human soluble Liver X Receptor beta,sLXR-beta ELISA Kit	96 Test	38220090	24,500.00
CLS0426HU	Human soluble Liver X Receptor alpha,sLXR-alpha ELISA Kit	96 Test	38220090	24,500.00
CLS0427HU	Human T-lymphocyte activation antigen CD86,CD86 ELISA Kit	96 Test	38220090	24,500.00
CLS0428HU	Human T-H glycoprotein,THP ELISA Kit	96 Test	38220090	24,500.00
CLS0429HU	Human T-cell surface glycoprotein CD3 zeta chain (CD247) ELISA Kit	96 Test	38220090	24,500.00
CLS0430HU	Human T-cell acute lymphoblastic leukemia antigen,TALLA-1 ELISA Kit	96 Test	38220090	24,500.00
CLS0431HU	Human T cell growth factor III,TCGF-III ELISA Kit	96 Test	38220090	24,500.00
CLS0432HU	Human Synuclein-gamma,SNCG ELISA Kit	96 Test	38220090	24,500.00
CLS0433HU	Human Syndecan 1(SDC1)ELISA Kit	96 Test	38220090	24,500.00
CLS0434HU	Human Suppressors Of Cytokine Signaling 1 (SOCS1)ELISA Kit	96 Test	38220090	24,500.00
CLS0435HU	Human Superoxide Dismutase, Copper Chaperone (SOD4)ELISA Kit	96 Test	38220090	24,500.00
CLS0436HU	Human Super Oxidase Dimutase,SOD ELISA Kit	96 Test	38220090	24,500.00
CLS0437HU	Human sulfatide,SFT ELISA Kit	96 Test	38220090	24,500.00
CLS0438HU	Human Sulfated-glycosaminoglycan,S-GAG ELISA Kit	96 Test	38220090	24,500.00
CLS0439HU	Human Succinyl coenzyme A synthetase (SCS) ELISA Kit	96 Test	38220090	24,500.00
CLS0440HU	Human substance P receptor,SP-R ELISA Kit	96 Test	38220090	24,500.00
CLS0441HU	Human Stromelysin-1,ST1 ELISA K	96 Test	38220090	24,500.00
CLS0442HU	Human Stromal cell derived factor 1beta,SDF-1beta ELISA kit	96 Test	38220090	24,500.00
CLS0443HU	Human Stress-associated endoplasmic reticulum protein 1,SERP1 ELISA Kit	96 Test	38220090	24,500.00
CLS0444HU	Human Statherin (STATH)ELISA Kit	96 Test	38220090	24,500.00
CLS0445HU	Human sreum albumin,HSA ELISA Kit	96 Test	38220090	24,500.00
CLS0446HU	Human sphingosine 1 phosphate,S1P ELISA Kit	96 Test	38220090	24,500.00
CLS0447HU	Human Sorcin (SRI)ELISA Kit	96 Test	38220090	24,500.00
CLS0448HU	Human Transcobalamin II, Macrocytic Anemia (TCN2)ELISA Kit	96 Test	38220090	24,500.00
CLS0449HU	Human total Procollagen Type I Intact N-terminal Propeptide,total-P1NP ELISA Kit	96 Test	38220090	24,500.00
CLS0450HU	Human total cholesterol,TC ELISA Kit	96 Test	38220090	24,500.00
CLS0451HU	Human Total Carnitine,TC ELISA Kit	96 Test	38220090	24,500.00
CLS0452HU	Human Toll-like receptor 10,TLR10 ELISA Kit	96 Test	38220090	24,500.00
CLS0453HU	Human Toll-like receptor 9,TLR-9 ELISA kit	96 Test	38220090	24,500.00
CLS0454HU	Human Toll-like receptor 1,TLR1 ELISA Kit	96 Test	38220090	24,500.00
CLS0455HU	Human TNF alpha converting enzyme,TACE ELISA Kit	96 Test	38220090	24,500.00
CLS0456HU	Human TNF related activation induced cytokine,TRANCE ELISA Kit	96 Test	38220090	24,500.00
CLS0457HU	Human TNF receptor-associated factor 2,TRAF2 ELISA Kit	96 Test	38220090	24,500.00
CLS0458HU	Human tissue polypeptide specific antigen,TPS ELISA Kit	96 Test	38220090	24,500.00
CLS0459HU	Human Tissue Polypeptide Antigen,TPA ELISA Kit	96 Test	38220090	24,500.00
CLS0460HU	Human tissue inhibitors of metalloproteinase 2,TIMP-2 ELISA Kit	96 Test	38220090	24,500.00
CLS0461HU	Human tissue inhibitors of metalloproteinase 1,TIMP-1 ELISA Kit	96 Test	38220090	24,500.00
CLS0462HU	Human Tissue factor pathway inhibitor,TFPI ELISA Kit	96 Test	38220090	24,500.00
CLS0463HU	Human Thyroxine-Binding Globulin,TBG ELISA Kit	96 Test	38220090	24,500.00
CLS0464HU	Human thyrotropin-releasing hormone,TRH ELISA KIT	96 Test	38220090	24,500.00

Cat.No.	Product Description	Pack Size	HSN	Unit Price
CLS0465HU	Human thymus activation regulated chemokine,TARC ELISA Kit	96 Test	38220090	24,500.00
CLS0466HU	Human Thymosin alpha1(Thymosin alpha1)ELISA Kit	96 Test	38220090	24,500.00
CLS0467HU	Human thymidylate synthetase,TS ELISA Kit	96 Test	38220090	24,500.00
CLS0468HU	Human thymidinephosphorylase,TP ELISA Kit	96 Test	38220090	24,500.00
CLS0469HU	Human Thymidine Kinase 1,Soluble(TK1) ELISA Kit	96 Test	38220090	24,500.00
CLS0470HU	Human thymic stromal lymphopoietin, TSLP ELISA Kit	96 Test	38220090	24,500.00
CLS0471HU	Human Thrombospondin 4 (TSP-4)ELISA Kit	96 Test	38220090	24,500.00
CLS0472HU	Human Thrombospondin 3 (TSP-3)ELISA Kit	96 Test	38220090	24,500.00
CLS0473HU	Human thrombinthrombomodulin compound,T-TM ELISA Kit	96 Test	38220090	24,500.00
CLS0474HU	Human thrombin receptor,TR ELISA Kit	96 Test	38220090	24,500.00
CLS0475HU	Human Thrombin activatable fibrinolysis inhibitor,TAFI ELISA Kit	96 Test	38220090	24,500.00
CLS0476HU	Human TGF-beta receptor type-1,TGFBR1 ELISA Kit	96 Test	38220090	24,500.00
CLS0477HU	Human Teratocarcinoma Derived Growth Factor 1 (TDGF1)ELISA Kit	96 Test	38220090	24,500.00
CLS0478HU	Human tartrate-resistant acid phosphatase 5b,TRACP-5b ELISA Kit	96 Test	38220090	24,500.00
CLS0479HU	Human TAR DNA binding protein 43,TARDBP/TDP-43 ELISA Kit	96 Test	38220090	24,500.00
CLS0480HU	Human talin(TLN)ELISA Kit	96 Test	38220090	24,500.00
CLS0481HU	Human Tumor necrosis factor ligand superfamily member 10,Tnfsf10/Trail ELISA Kit	96 Test	38220090	24,500.00
CLS0482HU	Human Tumor Marker CA724,TM-CA724 ELISA Kit	96 Test	38220090	24,500.00
CLS0483HU	Human Tumor Marker CA50,TM-CA50 ELISA Kit	96 Test	38220090	24,500.00
CLS0484HU	Human Trypsinogen-2,Try- II ELISA Kit	96 Test	38220090	24,500.00
CLS0485HU	Human trypsinogen activation peptide,TAP ELISA Kit	96 Test	38220090	24,500.00
CLS0486HU	Human True insulin,TI ELISA Kit	96 Test	38220090	24,500.00
CLS0487HU	Human Troponin T,Tn-T ELISA Kit	96 Test	38220090	24,500.00
CLS0488HU	Human transthyretin,TTR ELISA Kit	96 Test	38220090	24,500.00
CLS0489HU	Human Transmembrane Protease, Serine 2 (TMPRSS2)ELISA Kit	96 Test	38220090	24,500.00
CLS0490HU	Human Transient Receptor Potential Cation Channel Subfamily V, Member 1 (TRPV1)ELISA Kit	96 Test	38220090	24,500.00
CLS0491HU	Human Transglutaminase-3,TGM3 ELISA Kit	96 Test	38220090	24,500.00
CLS0492HU	Human Transforming Growth factor beta,TGF-beta ELISA kit	96 Test	38220090	24,500.00
CLS0493HU	Human Transferrin(TRF)ELISA Kit	96 Test	38220090	24,500.00
CLS0494HU	Human transferrin receptor,TFR ELISA Kit	96 Test	38220090	24,500.00
CLS0495HU	Human Transferrin receptor 2,TFR2 ELISA Kit	96 Test	38220090	24,500.00
CLS0496HU	Human Transcription factor GATA-5,GATA5 ELISA Kit	96 Test	38220090	24,500.00
CLS0497HU	Human Tumour necrosis factor related weak inducer of apoptosis,TWEAK ELISA Kit	96 Test	38220090	24,500.00
CLS0498HU	Human Tumor necrosis factor receptor superfamily member 5,CD40/TNFRSF5 ELISA Kit	96 Test	38220090	24,500.00
CLS0499HU	Human platelet-derived growth factor receptor,PDGFR ELISA Kit	96 Test	38220090	24,500.00
CLS0500HU	Human C-telopeptide of type I collagen,CTX- I ELISA Kit	96 Test	38220090	24,500.00
CLS0501HU	Human 50% complement hemolysis,CH50 ELISA Kit	96 Test	38220090	24,500.00
CLS0502HU	Human Atrial Natriuretic Peptide,ANP ELISA Kit	96 Test	38220090	24,500.00
CLS0503HU	Human beta-lipotropic hormone,beta-LPH ELISA Kit	96 Test	38220090	24,500.00
CLS0504HU	Human beta-glucuronidase,beta-GD ELISA Kit	96 Test	38220090	24,500.00
CLS0505HU	Human beta-glucosidase,beta-GLU ELISA Kit	96 Test	38220090	24,500.00
CLS0506HU	Human beta2 macroglobulin,beta2-MG ELISA	96 Test	38220090	24,500.00
CLS0507HU	Human Cluster of differentiation 3,CD3 ELISA Kit	96 Test	38220090	24,500.00
CLS0508HU	Human Cholic acid,CA ELISA Kit	96 Test	38220090	24,500.00
CLS0509HU	Human Isoform 2 of Prostatic acid phosphatase(I2PAP)ELISA Kit	96 Test	38220090	24,500.00

Cat.No.	Product Description	Pack Size	HSN	Unit Price
CLS0510HU	Human Complement fragment 5a,C5a ELISA Kit	96 Test	38220090	24,500.00
CLS0511HU	Human colon cancer-specific antigen-3,CCSA-3 ELISA kit	96 Test	38220090	24,500.00
CLS0512HU	Human Nuclear factor-kappa B,NF-kB ELISA Kit	96 Test	38220090	24,500.00
CLS0513HU	Human Lipoxin A4,LXA4 ELISA Kit	96 Test	38220090	24,500.00
CLS0514HU	human Resistin(Retn) ELISA KIT	96 Test	38220090	24,500.00
CLS0515HU	Human Podocalyxin,PCX ELISA Kit	96 Test	38220090	24,500.00
CLS0516HU	Human Stem cell factor/mast cell growth factor,SCF/MGF ELISA kit	96 Test	38220090	24,500.00
CLS0517HU	Human S100 Calcium Binding Protein A15 ,S100A15 ELISA Kit	96 Test	38220090	24,500.00
CLS0518HU	Human S100 Calcium Binding Protein A12 ,S100A12 ELISA Kit	96 Test	38220090	24,500.00
CLS0519HU	Human Tissue factor pathway inhibitor 1,TFPI-1 ELISA Kit	96 Test	38220090	24,500.00
CLS0520HU	Human Telomerase,TE ELISA Kit	96 Test	38220090	24,500.00
CLS0521HU	Human anti-Survivin antibody,Surv ELISA Kit	96 Test	38220090	24,500.00
CLS0522HU	Human 1,25-dihydroxyvitamin D(3) 24-hydroxylase,CYP24A1 ELISA Kit	96 Test	38220090	24,500.00
CLS0523HU	Human 1,25-hydroxyvitamin D (1,25- (OH)D) ELISA Kit	96 Test	38220090	24,500.00
CLS0524HU	Human 17-alpha-hydroxylase,17-alpha-OH ELISA Kit	96 Test	38220090	24,500.00
CLS0525HU	Human 11-Deoxycortisol ELISA Kit	96 Test	38220090	24,500.00
CLS0526HU	Human 25-Dihydroxy vitamin D (25-OH-D) ELISA Kit	96 Test	38220090	24,500.00
CLS0527HU	Human 5-Hydroxytryptamine,5HT ELISA Kit	96 Test	38220090	24,500.00
CLS0528HU	Human 5-hydroxyindoleacetic acid,5-HIAA ELISA Kit	96 Test	38220090	24,500.00
CLS0529HU	Human 4-Hydroxynonenal,4HNE ELISA Kit	96 Test	38220090	24,500.00
CLS0530HU	Human 5-Nucleotidase,5-NT ELISA Kit	96 Test	38220090	24,500.00
CLS0531HU	Human A Disintegrin And Metalloprotease 10,ADAM10 ELISA Kit	96 Test	38220090	24,500.00
CLS0532HU	Human 8-iso prostaglandin(8-iso-PG) ELISA Kit	96 Test	38220090	24,500.00
CLS0533HU	Human 8-iso prostaglandin F2α,8-iso-PGF2a ELISA Kit	96 Test	38220090	24,500.00
CLS0534HU	Human Acetyl Coenzyme A,A-COA ELISA Kit	96 Test	38220090	24,500.00
CLS0535HU	Human A Disintegrin And Metalloprotease 33,ADAM33 ELISA Kit	96 Test	38220090	24,500.00
CLS0536HU	Human Acid Phosphatase 5, TartRate Resistant(ACP5)ELISA Kit	96 Test	38220090	24,500.00
CLS0537HU	Human Acetylcholinesterase,AChE ELISA Kit	96 Test	38220090	24,500.00
CLS0538HU	Human Activin receptor-like kinase 1,ALK1 ELISA Kit	96 Test	38220090	24,500.00
CLS0539HU	Human activated protein C,APC ELISA Kit	96 Test	38220090	24,500.00
CLS0540HU	Human acidic fibroblast growth factor 1,aFGF-1 ELISA Kit	96 Test	38220090	24,500.00
CLS0541HU	Human ADAM metallopeptidase with thrombospondin type 1 motif4,ADAMTS4 ELISA kit	96 Test	38220090	24,500.00
CLS0542HU	Human Acyloxyacyl Hydrolase (AOAH)ELISA Kit	96 Test	38220090	24,500.00
CLS0543HU	Human Aryl Hydrocarbon Receptor Repressor (AHRR)ELISA Kit	96 Test	38220090	24,500.00
CLS0544HU	Human Artemin (ARTN)ELISA Kit	96 Test	38220090	24,500.00
CLS0545HU	Human Aromatase(ARO)ELISA Kit	96 Test	38220090	24,500.00
CLS0546HU	Human Adenomatosis Polyposis Coli Protein (APC)ELISA kit	96 Test	38220090	24,500.00
CLS0547HU	Human Astrotactin 2 (ASTN2)ELISA Kit	96 Test	38220090	24,500.00
CLS0548HU	Human aspergillus galactomannan,GM ELISA Kit	96 Test	38220090	24,500.00
CLS0549HU	Human Aspartate aminotransferase,AST ELISA Kit	96 Test	38220090	24,500.00
CLS0550HU	Human ATP-sensitive inward rectifier potassium channel 10,KCNJ10/Kir4.1 ELISA Kit	96 Test	38220090	24,500.00
CLS0551HU	Human ATP-binding cassette transporter G2,ABCG2 ELISA Kit	96 Test	38220090	24,500.00
CLS0552HU	Human ATP-binding cassette transporter A1,ABCA1 ELISA Kit	96 Test	38220090	24,500.00
CLS0553HU	Human Azurocidin,AZU ELISA Kit	96 Test	38220090	24,500.00
CLS0554HU	Human Atrial natriuretic peptide-converting enzyme,CORIN ELISA Kit	96 Test	38220090	24,500.00

Cat.No.	Product Description	Pack Size	HSN	Unit Price
CLS0555HU	Human Atrial natriuretic peptide,h-ANP ELISA kit	96 Test	38220090	24,500.00
CLS0556HU	Human B-Lymphocyte Chemoattractant 1,BLC-1 ELISA Kit	96 Test	38220090	24,500.00
CLS0557HU	Human B-Cell Linker Protein,BLNC ELISA Kit	96 Test	38220090	24,500.00
CLS0558HU	Human B cell differentiation factor,BCDF ELISA Kit	96 Test	38220090	24,500.00
CLS0559HU	Human B-type natriuretic peptide(BNP)ELISA Kit	96 Test	38220090	24,500.00
CLS0560HU	Human basic fibroblast growth factor 9,bFGF-9 ELISA Kit	96 Test	38220090	24,500.00
CLS0561HU	Human Bactericidal permeability-increasing protein,BPI ELISA Kit	96 Test	38220090	24,500.00
CLS0562HU	Human beta 2 transferrin (beta2TF) ELISA kit	96 Test	38220090	24,500.00
CLS0563HU	Human Beta 2 Cardioplin 1(β 2-GP1)ELISA Kit	96 Test	38220090	24,500.00
CLS0564HU	Human Beclin1,BECN1 ELISAkit	96 Test	38220090	24,500.00
CLS0565HU	Human beta-chain of high-affinity Receptor I for the Fc region of immunoglobulin E ,Fc ϵ R1beta ELISA Kit	96 Test	38220090	24,500.00
CLS0566HU	Human beta-arrestin 1,ARRB1 ELISA Kit	96 Test	38220090	24,500.00
CLS0567HU	Human beta-catenin,beta-Cat ELISA Kit	96 Test	38220090	24,500.00
CLS0568HU	Human Beta-defensin 3,DEFB3 ELISA kit	96 Test	38220090	24,500.00
CLS0569HU	Human Beta-defensin 2, DEFB2 ELISA kit	96 Test	38220090	24,500.00
CLS0570HU	Human Beta-defensin 1,DEFB1 ELISA kit	96 Test	38220090	24,500.00
CLS0571HU	Human Beta-Hydroxybutyric Acid,Beta-OHB ELISA Kit	96 Test	38220090	24,500.00
CLS0572HU	Human beta-galactosidase(beta-GAL)ELISA Kit	96 Test	38220090	24,500.00
CLS0573HU	Human Bladder tumor antigen,BTA ELISA Kit	96 Test	38220090	24,500.00
CLS0574HU	Human Biopyrrin(BPn) ELISA Kit	96 Test	38220090	24,500.00
CLS0575HU	Human Bone Morphogenetic Protein 15 (BMP15)ELISA kit	96 Test	38220090	24,500.00
CLS0576HU	Human Bone Morphogenetic Protein 4 (BMP4)ELISA kit	96 Test	38220090	24,500.00
CLS0577HU	Human bone alkaline phosphatase,BALP ELISA Kit	96 Test	38220090	24,500.00
CLS0578HU	Human Bone Morphogenetic Protein 8b (BMP8b)ELISA kit	96 Test	38220090	24,500.00
CLS0579HU	Human Bone Morphogenetic Protein 6,BMP-6 ELISA Kit	96 Test	38220090	24,500.00
CLS0580HU	Human Brain derived neurotrophic factor,BDNF ELISA Kit	96 Test	38220090	24,500.00
CLS0581HU	Human bone sialoprotein,BSP ELISA Kit	96 Test	38220090	24,500.00
CLS0582HU	Human Butyrylcholinesterase (BCHE)ELISA Kit	96 Test	38220090	24,500.00
CLS0583HU	Human Bruton tyrosine kinase,Btk ELISA Kit	96 Test	38220090	24,500.00
CLS0584HU	Human Breast and kidney expressed chemokine,BRAK ELISA Kit	96 Test	38220090	24,500.00
CLS0585HU	Human brain natriuretic peptide,BNP ELISA Kit	96 Test	38220090	24,500.00
CLS0586HU	Human c-fos(c-fos)ELISA Kit	96 Test	38220090	24,500.00
CLS0587HU	Human C-C motif chemokine 26(CCL26) ELISA Kit	96 Test	38220090	24,500.00
CLS0588HU	Human monocyte chemotactic protein 1,MCP-1/MCAF/CCCL2 ELISA kit	96 Test	38220090	24,500.00
CLS0589HU	Human C-Raf Proto Oncogene Serine/Threonine Protein Kinase (CRAF)ELISA Kit	96 Test	38220090	24,500.00
CLS0590HU	Human Inhibin,INH-A ELISA Kit	96 Test	38220090	24,500.00
CLS0591HU	Human CX3C-chemokine/Fractalkine,FKN/CX3CL1 ELISA Kit	96 Test	38220090	24,500.00
CLS0592HU	Human C-Reactive Protein,CRP ELISA Kit	96 Test	38220090	24,500.00
CLS0593HU	Human C1q/TNF-related protein-3,Cartonectin/CTRP3/CORS-26 ELISA Kit	96 Test	38220090	24,500.00
CLS0594HU	Human cross linked N-telopeptide of type I collagen,NTX ELISA Kit	96 Test	38220090	24,500.00
CLS0595HU	Human Creatine Kinase MM isoenzyme,CK-MM ELISA Kit	96 Test	38220090	24,500.00
CLS0596HU	Human Cuticular Active Peptide Factor,CAPF ELISA Kit	96 Test	38220090	24,500.00
CLS0597HU	Human cutaneous T cell-attracting chemokine,CTACK ELISA Kit	96 Test	38220090	24,500.00
CLS0598HU	Human Cross-linked Carboxy-terminal telopeptide of type I collagen, I CTP ELISA Kit	96 Test	38220090	24,500.00
CLS0599HU	Human Cyclic AMP-dependent transcription factor ATF-6,ATF-6 ELISA Kit	96 Test	38220090	24,500.00
CLS0600HU	Human CXC-chemokine ligand 16,CXCL16 ELISA Kit	96 Test	38220090	24,500.00

Cat.No.	Product Description	Pack Size	HSN	Unit Price
CLS0601HU	Human CX3C-chemokine receptor 1,CX3CR1 ELISA Kit	96 Test	38220090	24,500.00
CLS0602HU	Human Cyclin-D2(Cyclin-D2)ELISA Kit	96 Test	38220090	24,500.00
CLS0603HU	Human Cysteine Rich Transmembrane BMP Regulator 1 (CRIM1)ELISA kit	96 Test	38220090	24,500.00
CLS0604HU	Human cyclooxygenase-receptor2,COX-2R ELISA Kit	96 Test	38220090	24,500.00
CLS0605HU	Human Cytochrome P450 19A1,CYP19A1 ELISA Kit	96 Test	38220090	24,500.00
CLS0606HU	Human cytochrome P450 3A4,CYP3A4 ELISA Kit	96 Test	38220090	24,500.00
CLS0607HU	Human cysteinyl leukotrienes,CysLTs ELISA Kit	96 Test	38220090	24,500.00
CLS0608HU	Human cytokeratin 18,CK-18 ELISA Kit	96 Test	38220090	24,500.00
CLS0609HU	Human Cytoglobin (CYGB)ELISA Kit	96 Test	38220090	24,500.00
CLS0610HU	Human Cytochrome-C,Cyt-C ELISA Kit	96 Test	38220090	24,500.00
CLS0611HU	Human cytokeratin 19,CK-19 ELISA Kit	96 Test	38220090	24,500.00
CLS0612HU	Human cytokeratin 18-M65,CK-18-M65 ELISA Kit	96 Test	38220090	24,500.00
CLS0613HU	Human Cytokeratin 18-M30,CK 18-M30 ELISA kit	96 Test	38220090	24,500.00
CLS0614HU	Human decay-accelerating factor,DAF ELISA Kit	96 Test	38220090	24,500.00
CLS0615HU	Human D-amino Acid Oxidase Activator (DAOA)ELISA Kit	96 Test	38220090	24,500.00
CLS0616HU	Human cytokinin MB,CKMB ELISA Kit	96 Test	38220090	24,500.00
CLS0617HU	Human deoxyribonucleic protein antibody,DNP-Ab ELISA Kit	96 Test	38220090	24,500.00
CLS0618HU	Human Deiodinase Iodothyronine Type II (DIO2)ELISA Kit	96 Test	38220090	24,500.00
CLS0619HU	Human deubiquitinating enzyme,DUB ELISA Kit	96 Test	38220090	24,500.00
CLS0620HU	Human desmogleins 1,Dsg-1 ELISA Kit	96 Test	38220090	24,500.00
CLS0621HU	Human dermatan sulfate,DS ELISA Kit	96 Test	38220090	24,500.00
CLS0622HU	Human Dickkopf-1,DKK1 ELISA Kit	96 Test	38220090	24,500.00
CLS0623HU	Human Dickkopf Related Protein 2 (DKK2)ELISA Kit	96 Test	38220090	24,500.00
CLS0624HU	Human Diacylglycerol-O-Acyltransferase Homolog 1 (DGAT1)ELISA Kit	96 Test	38220090	24,500.00
CLS0625HU	Human diacyl glycerol,DAG/DG ELISA kit	96 Test	38220090	24,500.00
CLS0626HU	Human Dickkopf-4,DKK4 ELISA Kit	96 Test	38220090	24,500.00
CLS0627HU	Human Dickkopf-3,DKK3 ELISA Kit	96 Test	38220090	24,500.00
CLS0628HU	Human dipeptidyl peptidase 4,DPP4 ELISA Kit	96 Test	38220090	24,500.00
CLS0629HU	Human Dihydrotestosterone,DHT ELISA Kit	96 Test	38220090	24,500.00
CLS0630HU	Human Dihydropyrimidine Dehydrogenase,DPYD ELISA Kit	96 Test	38220090	24,500.00
CLS0631HU	Human E1/ubiquitin-activating enzyme,E1/UBAE ELISA Kit	96 Test	38220090	24,500.00
CLS0632HU	Human Dystrophin(DMD)ELISA Kit	96 Test	38220090	24,500.00
CLS0633HU	Human Dual Specificity Phosphatase 1 (DUSP1)ELISA kit	96 Test	38220090	24,500.00
CLS0634HU	Human Early prostate cancer antigen 2,EPCA2 ELISA Kit	96 Test	38220090	24,500.00
CLS0635HU	Human E3/ubiquitin-protein ligase,E3/UBPL ELISA Kit	96 Test	38220090	24,500.00
CLS0636HU	Human E2/ubiquitin-conjugating enzyme,E2/UBCE ELISA Kit	96 Test	38220090	24,500.00
CLS0637HU	Human Endometrium Antibody,EMAb ELISA Kit	96 Test	38220090	24,500.00
CLS0638HU	human Heterogeneous Nuclear Ribonucleoprotein L (HNRNPL) ELISA	96 Test	38220090	24,500.00
CLS0639HU	human Endothelin 1,ET-1 ELISA Kit	96 Test	38220090	24,500.00
CLS0640HU	Human Endothelial cell-specific molecule 1,ESM-1 ELISA kit	96 Test	38220090	24,500.00
CLS0641HU	Human High mobility group protein B1,HMGB-1 ELISA Kit	96 Test	38220090	24,500.00
CLS0642HU	Human High density lipoprotein,HDL ELISA Kit	96 Test	38220090	24,500.00
CLS0643HU	Human High density lipoprotein cholesterol,HDL-C ELISA Kit	96 Test	38220090	24,500.00
CLS0644HU	Human histone deacetylase 6,HDAC6 ELISA KIT	96 Test	38220090	24,500.00
CLS0645HU	human Histocompatibility 2-K1-K region,H2-K1 ELISA Kit	96 Test	38220090	24,500.00
CLS0646HU	Human High sensitive cardiac troponin,hs-cTn ELISA	96 Test	38220090	24,500.00
CLS0647HU	Human Homocysteine,Hcy ELISA Kit	96 Test	38220090	24,500.00
CLS0648HU	Human Homeobox protein Nkx-2.1,NKX2-1 ELISA Kit	96 Test	38220090	24,500.00
CLS0649HU	Human Hyaluronan synthase 2,HAS2 ELISA Kit	96 Test	38220090	24,500.00
CLS0650HU	Human Ig-like transcripts Receptor,ILTsR ELISA Kit	96 Test	38220090	24,500.00

Cat.No.	Product Description	Pack Size	HSN	Unit Price
CLS0651HU	Human Hypoxia Inducible Factor 2 Alpha (HIF2a)ELISA Kit	96 Test	38220090	24,500.00
CLS0652HU	Human Hydroxyproline-Rich Glycoprotein,HRGP ELISA Kit	96 Test	38220090	24,500.00
CLS0653HU	Human Hyaluronidase,HAase ELISA Kit	96 Test	38220090	24,500.00
CLS0654HU	Human Immunoglobulin D,IgD ELISA Kit	96 Test	38220090	24,500.00
CLS0655HU	Human immunosuppressive acidic protein,IAP ELISA Kit	96 Test	38220090	24,500.00
CLS0656HU	Human Immunoglobulin G3,IgG3 ELISA Kit	96 Test	38220090	24,500.00
CLS0657HU	Human Immunoglobulin G2,IgG2 ELISA Kit	96 Test	38220090	24,500.00
CLS0658HU	Human Immunoglobulin G1,IgG1 ELISA Kit	96 Test	38220090	24,500.00
CLS0659HU	Human Insulin receptor substrate 1,IRS-1 ELISA Kit	96 Test	38220090	24,500.00
CLS0660HU	Human inosine 5-monophosphate(IMPDH)ELISA Kit	96 Test	38220090	24,500.00
CLS0661HU	Human Insulin Receptor beta,ISR-beta ELISA KIT	96 Test	38220090	24,500.00
CLS0662HU	Human Insulin receptor substrate 4,IRS-4 ELISA Kit	96 Test	38220090	24,500.00
CLS0663HU	Human Insulin receptor substrate 2,IRS-2 ELISA Kit	96 Test	38220090	24,500.00
CLS0664HU	Human insulin-like growth factors 2,IGF-2 ELISA Kit	96 Test	38220090	24,500.00
CLS0665HU	Human insulin-like growth factors 1,IGF-1 ELISA Kit	96 Test	38220090	24,500.00
CLS0666HU	Human Interferon ω,IFN-ω ELISA Kit	96 Test	38220090	24,500.00
CLS0667HU	human interferon regulatory factor 3,IRF3 ELISA Kit	96 Test	38220090	24,500.00
CLS0668HU	Human intercellular adhesion molecule 2,ICAM-2 ELISA Kit	96 Test	38220090	24,500.00
CLS0669HU	Human Interleukin 1 Family, Member 9 (IL1F9)ELISA Kit	96 Test	38220090	24,500.00
CLS0670HU	Human Interleukin 12,IL-12 ELISA Kit	96 Test	38220090	24,500.00
CLS0671HU	Human Interleukin 12 Receptor beta 2(IL12Rb2)ELISA Kit	96 Test	38220090	24,500.00
CLS0672HU	Human Interleukin 1 Receptor Accessory Protein (IL1RAP)ELISA Kit	96 Test	38220090	24,500.00
CLS0673HU	Human Interleukin 17C,IL-17C ELISA Kit	96 Test	38220090	24,500.00
CLS0674HU	Human Interleukin 17B,IL-17B ELISA Kit	96 Test	38220090	24,500.00
CLS0675HU	Human Interleukin 17A,IL-17A ELISA Kit	96 Test	38220090	24,500.00
CLS0676HU	Human Interleukin 13,IL-13 ELISA KIT	96 Test	38220090	24,500.00
CLS0677HU	Human Interleukin 17F,IL-17F ELISA Kit	96 Test	38220090	24,500.00
CLS0678HU	Human Interleukin 17D,IL-17D ELISA Kit	96 Test	38220090	24,500.00
CLS0679HU	Human Interleukin 2,IL-2 ELISA kit	96 Test	38220090	24,500.00
CLS0680HU	Human Interleukin 25,IL-25 ELISA Kit	96 Test	38220090	24,500.00
CLS0681HU	Human Interleukin 23,IL-23 ELISA Kit	96 Test	38220090	24,500.00
CLS0682HU	Human Interleukin 22,IL-22 ELISA kit	96 Test	38220090	24,500.00
CLS0683HU	Human Interleukin 28A,IL-28A/IFN-λ2 ELISA Kit	96 Test	38220090	24,500.00
CLS0684HU	human Interleukin 27,IL-27 ELISA Kit	96 Test	38220090	24,500.00
CLS0685HU	Human Interleukin 26,IL-26 ELISA Kit	96 Test	38220090	24,500.00
CLS0686HU	Human Mucin-7,MUC7 ELISA Kit	96 Test	38220090	24,500.00
CLS0687HU	Human mucin-5 subtype B,MUC5B ELISA kit	96 Test	38220090	24,500.00
CLS0688HU	Human Mucin-5 subtype AC,MUC5AC ELISA Kit	96 Test	38220090	24,500.00
CLS0689HU	Human multidrug resistance-associated protein,MRP ELISA Kit	96 Test	38220090	24,500.00
CLS0690HU	Human mucosal addressin cell adhesion molecule-1,MAcCAM-1 ELISA Kit	96 Test	38220090	24,500.00
CLS0691HU	Human Mucin-8,MUC8 ELISA Kit	96 Test	38220090	24,500.00
CLS0692HU	Human Muscarinic receptor1(CHRM1)ELISA Kit	96 Test	38220090	24,500.00
CLS0693HU	Human muscarinic acetylcholine receptor M4,M-AChR M4 ELISA Kit	96 Test	38220090	24,500.00
CLS0694HU	Human Multiple myeloma tumor-associated protein 2(C1orf35) ELISA kit	96 Test	38220090	24,500.00
CLS0695HU	Human Myelin-oligodendrocyte glycoprotein(MOG)ELISA Kit	96 Test	38220090	24,500.00
CLS0696HU	Human Myelin associated glycoprotein,MAG ELISA Kit	96 Test	38220090	24,500.00
CLS0697HU	Human Muscle-specific RING finger protein 1,MuRF1 ELISA Kit	96 Test	38220090	24,500.00
CLS0698HU	Human Myeloperoxidase-antineutrophil cytoplasmic antibody IgG,MPO-ANCA IgG ELISA kit	96 Test	38220090	24,500.00
CLS0699HU	Human myeloperoxidase,MPO ELISA Kit	96 Test	38220090	24,500.00

Cat.No.	Product Description	Pack Size	HSN	Unit Price
CLS0700HU	Human Myeloid Progenitor Inhibitory Factor 1,MPIF-1 ELISA Kit	96 Test	38220090	24,500.00
CLS0701HU	human myeloid differentiation primary response gene 88,MYD88 ELISA Kit	96 Test	38220090	24,500.00
CLS0702HU	Human N-Acetyl Beta-D-Glucosaminidase,NAGase ELISA Kit	96 Test	38220090	24,500.00
CLS0703HU	Human Myo-inositol oxygenase,MIOX ELISA Kit	96 Test	38220090	24,500.00
CLS0704HU	Human Myocilin (MYOC)ELISA Kit	96 Test	38220090	24,500.00
CLS0705HU	Human N-methyl-d-aspartic acid,NMDA ELISA Kit	96 Test	38220090	24,500.00
CLS0706HU	Human N-Methyl-D-Aspartate Receptor 2,NMDAR2 ELISA Kit	96 Test	38220090	24,500.00
CLS0707HU	Human N-acetyl-β-D-glucosaminidase,NAG ELISA Kit	96 Test	38220090	24,500.00
CLS0708HU	Human N-terminal procollagen III propeptide,PⅢNP ELISA Kit	96 Test	38220090	24,500.00
CLS0709HU	Human N-terminal pro-brain natriuretic peptide,NT-proBNP ELISA KIT	96 Test	38220090	24,500.00
CLS0710HU	Human Na ⁺ /H ⁺ exchanger 3,NHE3 ELISA Kit	96 Test	38220090	24,500.00
CLS0711HU	Human Neopterin(NEOP) ELISA Kit	96 Test	38220090	24,500.00
CLS0712HU	Human Neogenin 1 (NEO1)ELISA Kit	96 Test	38220090	24,500.00
CLS0713HU	Human NAD-dependent deacetylase sirtuin-1(SIRT1/SIR2L1)ELISA Kit	96 Test	38220090	24,500.00
CLS0714HU	Human Nestin(NES) ELISA Kit	96 Test	38220090	24,500.00
CLS0715HU	Human Nesfatin1(Nes-1)ELISA kit	96 Test	38220090	24,500.00
CLS0716HU	Human neurofilament protein,NF ELISA Kit	96 Test	38220090	24,500.00
CLS0717HU	Human neurofilament protein L(NF-L)ELISA Kit	96 Test	38220090	24,500.00
CLS0718HU	Human Neural cell adhesion molecule ligand 1,NCAM-L1 ELISA Kit	96 Test	38220090	24,500.00
CLS0719HU	Human Neurogenic locus notch homolog protein 3,NOTCH3 ELISA Kit	96 Test	38220090	24,500.00
CLS0720HU	Human Neurogenic locus notch homolog protein 2,NOTCH2 ELISA Kit	96 Test	38220090	24,500.00
CLS0721HU	Human Neurogenic locus notch homolog protein 1,NOTCH1 ELISA Kit	96 Test	38220090	24,500.00
CLS0722HU	Human Neuron-specific enolase,NSE ELISA Kit	96 Test	38220090	24,500.00
CLS0723HU	Human Neurogenic locus notch homolog protein 4,NOTCH4 ELISA Kit	96 Test	38220090	24,500.00
CLS0724HU	Human neutrophil gelatinase-associated lipocalin,NGAL ELISA Kit	96 Test	38220090	24,500.00
CLS0725HU	Human neutrophil elastase,NE ELISA Kit	96 Test	38220090	24,500.00
CLS0726HU	Human Neuropilin-1(NRP1)ELISA kit	96 Test	38220090	24,500.00
CLS0727HU	Human Ninein/GSK3B interacting protein,NIN ELISA Kit	96 Test	38220090	24,500.00
CLS0728HU	Human Noggin,NOG ELISA Kit	96 Test	38220090	24,500.00
CLS0729HU	Human NOD-like receptor9,NLR ELISA Kit	96 Test	38220090	24,500.00
CLS0730HU	Human inducible nitric oxide synthase,iNOS ELISA KIT	96 Test	38220090	24,500.00
CLS0731HU	Human Protease Activated Receptor 2(PAR2) ELISA Kit	96 Test	38220090	24,500.00
CLS0732HU	Human Nuclear factor-κB p65(NF-κB p65)ELISA Kit	96 Test	38220090	24,500.00
CLS0733HU	Human Non-esterified fatty acid(NEFA)ELISA Kit	96 Test	38220090	24,500.00
CLS0734HU	Human Protein C,P-C ELISA Kit	96 Test	38220090	24,500.00
CLS0735HU	Human Protease Activated Receptor 4(PAR4) ELISA Kit	96 Test	38220090	24,500.00
CLS0736HU	Human Protease Activated Receptor 3(PAR3) ELISA Kit	96 Test	38220090	24,500.00
CLS0737HU	Human proteinase-antineutrophil cytoplasmic antibody,PR3-ANCA ELISA Kit	96 Test	38220090	24,500.00
CLS0738HU	Human Protein Z,P-Z ELISA Kit	96 Test	38220090	24,500.00
CLS0739HU	Human Protein Tyrosine Phosphatase Receptor Type S (PTPRS)ELISA Kit	96 Test	38220090	24,500.00
CLS0740HU	Human Protein S,P-S ELISA Kit	96 Test	38220090	24,500.00
CLS0741HU	Human prothrombin fragment 1+2,F1+2 ELISA kit	96 Test	38220090	24,500.00
CLS0742HU	Human proteolipid protein,PLP ELISA Kit	96 Test	38220090	24,500.00
CLS0743HU	Human RalA Binding Protein 1 (RALBP1)ELISA Kit	96 Test	38220090	24,500.00

Cat.No.	Product Description	Pack Size	HSN	Unit Price
CLS0744HU	Human pulmonary activation regulated chemokine,PARC ELISA Kit	96 Test	38220090	24,500.00
CLS0745HU	Human Prothymosin Alpha (PTMAAlpha)ELISA kit	96 Test	38220090	24,500.00
CLS0746HU	Human Receptor tyrosine-protein kinase erbB-2(ERBB2)ELISA Kit	96 Test	38220090	24,500.00
CLS0747HU	Human Receptor III for the Fc region of immunoglobulin G,FcgammaRIII/CD16 ELISA Kit	96 Test	38220090	24,500.00
CLS0748HU	Human Reactive oxygen species modulator 1(ROMO1)ELISA Kit	96 Test	38220090	24,500.00
CLS0749HU	Human Regenerating islet-derived protein 3-alpha,REG-3-alpha ELISA Kit	96 Test	38220090	24,500.00
CLS0750HU	Human Regenerating Islet Derived Protein 1 Alpha (REG1Alpha)ELISA Kit	96 Test	38220090	24,500.00
CLS0751HU	Human Reelin(RELN)ELISA Kit	96 Test	38220090	24,500.00
CLS0752HU	Human Rhodopsin (RHO)ELISA Kit	96 Test	38220090	24,500.00
CLS0753HU	Human Reverse Tri-iodothyronine,rT3 ELISA Kit	96 Test	38220090	24,500.00
CLS0754HU	Human Runt-Related Transcription Factor 2(RUNX2) ELISA Kit	96 Test	38220090	24,500.00
CLS0755HU	Human RIO Kinase 3 (RIOK3)ELISA Kit	96 Test	38220090	24,500.00
CLS0756HU	Human ribosome RNP antibody,rRNP-Ab ELISA Kit	96 Test	38220090	24,500.00
CLS0757HU	Human S100 Calcium Binding Protein A7 ,S100A7 ELISA Kit	96 Test	38220090	24,500.00
CLS0758HU	Human Ryanodine receptor 1,RyR1 ELISA kit	96 Test	38220090	24,500.00
CLS0759HU	Human Secreted Frizzled Related Protein 2 (SFRP2)ELISA kit	96 Test	38220090	24,500.00
CLS0760HU	Human Sclerostin domain-containing protein 1(SOSTDC1)ELISA Kit	96 Test	38220090	24,500.00
CLS0761HU	Human scavenger receptor B,SRB ELISA Kit	96 Test	38220090	24,500.00
CLS0762HU	Human secretory immunoglobulin A,SIgA ELISA Kit	96 Test	38220090	24,500.00
CLS0763HU	Human secretory leukocyte protease inhibitor,SLPI ELISA Kit	96 Test	38220090	24,500.00
CLS0764HU	Human Secretin(SCT) ELISA Kit	96 Test	38220090	24,500.00
CLS0765HU	Human Semaphorin 4D (SEMA4D)ELISA Kit	96 Test	38220090	24,500.00
CLS0766HU	Human Semaphorin 3F (SEMA3F)ELISA Kit	96 Test	38220090	24,500.00
CLS0767HU	Human Selenoprotein-S ,Se-S ELISA Kit	96 Test	38220090	24,500.00
CLS0768HU	Human Endoglin(ENG)ELISA Kit	96 Test	38220090	24,500.00
CLS0769HU	Human Semenogelin-1,SEMG1 ELISA Kit	96 Test	38220090	24,500.00
CLS0770HU	Human Semaphorin 7A (SEMA7A)ELISA Kit	96 Test	38220090	24,500.00
CLS0771HU	Human Signal peptide, CUB and EGF-like domain-containing protein 1(SCUBE1) ELISA Kit	96 Test	38220090	24,500.00
CLS0772HU	Human sex hormone-binding globulin,SHBG ELISA Kit	96 Test	38220090	24,500.00
CLS0773HU	Human Sex Determining Region Y Box Protein 2 (SOX2)ELISA kit	96 Test	38220090	24,500.00
CLS0774HU	Human Sirtuin 2 (SIRT2)ELISA Kit	96 Test	38220090	24,500.00
CLS0775HU	human signal transducer and activator of transcription 4,STAT4 ELISA Kit	96 Test	38220090	24,500.00
CLS0776HU	human soluble cluster of differentiation 28,sCD28 ELISA Kit	96 Test	38220090	24,500.00
CLS0777HU	Human soluble CD163 (sCD163)ELISA Kit	96 Test	38220090	24,500.00
CLS0778HU	Human soluble amyloid precursor protein beta,sAPP beta ELISA Kit	96 Test	38220090	24,500.00
CLS0779HU	Human soluble amyloid precursor protein alpha,sAPP alpha ELISA Kit	96 Test	38220090	24,500.00
CLS0780HU	Human soluble Interleukin 6 receptor,sIL-6R/CD126 ELISA Kit	96 Test	38220090	24,500.00
CLS0781HU	Human soluble Interleukin 2 receptor,IL-2sR ELISA Kit	96 Test	38220090	24,500.00
CLS0782HU	Human soluble Cluster of differentiation 86,sCD86 ELISA Kit	96 Test	38220090	24,500.00
CLS0783HU	Human Twisted Gastrulation Protein Homolog 1 (TWSG1)ELISA Kit	96 Test	38220090	24,500.00

Cat.No.	Product Description	Pack Size	HSN	Unit Price
CLS0784HU	Human Tumour Type M2 Pyruvate Kinase,TU M2PK ELISA Kit	96 Test	38220090	24,500.00
CLS0785HU	Human Soluble Lectin-like oxidized low density lipoprotein receptor-1,sLOX-1 ELISA Kit	96 Test	38220090	24,500.00
CLS0786HU	Human Tyrosinase antibody(Tyrosinase-Ab)ELISA Kit	96 Test	38220090	24,500.00
CLS0787HU	Human type II collagen helical peptide,HELIX-II ELISA Kit	96 Test	38220090	24,500.00
CLS0788HU	Human Ultrasensitivity Tri-iodothyronine,u-T3 ELISA Kit	96 Test	38220090	24,500.00
CLS0789HU	Human ultra Estriol,uE3 ELISA KIT	96 Test	38220090	24,500.00
CLS0790HU	Human Ubiquitin Carboxyl Terminal Hydrolase L1 (UCHL1)ELISA kit	96 Test	38220090	24,500.00
CLS0791HU	Human Undercarboxylated Osteocalcin (ucOC) ELISA Kit	96 Test	38220090	24,500.00
CLS0792HU	Human uncoupling protein 1, UCP1 ELISA Kit	96 Test	38220090	24,500.00
CLS0793HU	Human Urokinase-type Plasminogen Activator Receptor,PLAUR/uPAR ELISA kit	96 Test	38220090	24,500.00
CLS0794HU	Human urinary free cortisol,UFC ELISA Kit	96 Test	38220090	24,500.00
CLS0795HU	Human Urate Transporter 1,URAT1 ELISA Kit	96 Test	38220090	24,500.00
CLS0796HU	Human vanillylmandelic acid,VMA ELISA Kit	96 Test	38220090	24,500.00
CLS0797HU	Human Urotensin II(UII) ELISA Kit	96 Test	38220090	24,500.00
CLS0798HU	Human Vascular Endothelial cell Growth Factor C,VEGF-C ELISA KIT	96 Test	38220090	24,500.00
CLS0799HU	Human Vascular Endothelial cell Growth Factor B,VEGF-B ELISA KIT	96 Test	38220090	24,500.00
CLS0800HU	Human Vascular Endothelial cell Growth Factor,VEGF165 ELISA KIT	96 Test	38220090	24,500.00
CLS0801HU	Human Vascular Endothelial cell Growth Factor D,VEGF-D ELISA KIT	96 Test	38220090	24,500.00
CLS0802HU	human versican/Pg-M/Pg-350,VS ELISA kit	96 Test	38220090	24,500.00
CLS0803HU	Human Vasoactive Intestinal Peptide,VIP ELISA Kit	96 Test	38220090	24,500.00
CLS0804HU	Human Vascuoar endothelial cell growth factor receptor 2,VEGFR-2/Flk-1 ELISA kit	96 Test	38220090	24,500.00
CLS0805HU	Human vinculin,VCL ELISA Ki	96 Test	38220090	24,500.00
CLS0806HU	Human vimentin,VIM ELISA Kit	96 Test	38220090	24,500.00
CLS0807HU	Human very late appearing antigen 4,VLA4 ELISA Kit	96 Test	38220090	24,500.00
CLS0808HU	Human Visfatin(Visfatin)ELISA Kit	96 Test	38220090	24,500.00
CLS0809HU	Human Vitamin K,VK ELISA Kit	96 Test	38220090	24,500.00
CLS0810HU	Human Vitamin B12,VB12 ELISA Kit	96 Test	38220090	24,500.00
CLS0811HU	Human Vitamin B2,VB2 ELISA Kit	96 Test	38220090	24,500.00
CLS0812HU	Human Wingless Type MMTV Integration Site Family, Member 5B (WNT5B)ELISA Kit	96 Test	38220090	24,500.00
CLS0813HU	Human WNT1 Inducible Signaling Pathway Protein 2 (WISP2)ELISA Kit	96 Test	38220090	24,500.00
CLS0814HU	Human Wingless Type MMTV Integration Site Family, Member 7B (WNT7B)ELISA Kit	96 Test	38220090	24,500.00
CLS0815HU	Human Zinc-Alpha-2-Glycoprotein(ZAG) ELISA kit	96 Test	38220090	24,500.00
CLS0816HU	human Z-DNA binding protein 1,ZBP1 ELISA KIT	96 Test	38220090	24,500.00
CLS0817HU	Human X-box binding protein1 antibody (XBP1) ELISA Kit	96 Test	38220090	24,500.00
CLS0818HU	Human alpha-L-iduronidase,IDUA ELISA Kit	96 Test	38220090	24,500.00
CLS0819HU	Human alpha-Amylase,AMS/AMY ELISA Kit	96 Test	38220090	24,500.00
CLS0820HU	Human alpha-Smooth muscle actin,alpha-SMA ELISA Kit	96 Test	38220090	24,500.00
CLS0821HU	Human beta-Defensins,beta-DF ELISA Kit	96 Test	38220090	24,500.00
CLS0822HU	Human nitric oxide,NO ELISA Kit	96 Test	38220090	24,500.00
CLS0823HU	Human acetylcholine,ACH ELISA Kit	96 Test	38220090	24,500.00
CLS0824HU	Human cholesterol,CH ELISA Kit	96 Test	38220090	24,500.00
CLS0825HU	Human Ischemia Modified Albumin,IMA ELISA Kit	96 Test	38220090	24,500.00
CLS0826HU	Human Interleukin 1alpha,IL-1alpha ELISA Kit	96 Test	38220090	24,500.00
CLS0827HU	Human Retinal dehydrogenase 1,ALDH1A1 ELISA Kit	96 Test	38220090	24,500.00
CLS0828HU	Human Interleukin 6,IL-6 ELISA Kit	96 Test	38220090	24,500.00
CLS0829HU	Human Phospholipase D1 (PLD1)ELISA Kit	96 Test	38220090	24,500.00

Cat.No.	Product Description	Pack Size	HSN	Unit Price
CLS0830HU	Human 2,3-Disphosphoglycerate,2,3-DPG ELISA Kit	96 Test	38220090	24,500.00
CLS0831HU	Human placenta lactogen,HPL ELISA Kit	96 Test	38220090	24,500.00
CLS0832HU	Human Glycated hemoglobin A1c,GHbA1c ELISA Kit	96 Test	38220090	24,500.00
CLS0833HU	Human purine nucleoside phosphorylase(PNP)ELISA Kit	96 Test	38220090	24,500.00
CLS0834HU	Human hydroxyphenylpyruvate dioxygenase(HPD)ELISA Kit	96 Test	38220090	24,500.00
CLS0835HU	Human Malate Dehydrogenase(MDH)ELISA Kit	96 Test	38220090	24,500.00
CLS0836HU	Human Serotonin,ST ELISA Kit	96 Test	38220090	24,500.00
CLS0837HU	Human Epinephrine/Adrenaline,EPI ELISA Kit	96 Test	38220090	24,500.00
CLS0838HU	Human Noradrenaline,NA ELISA Kit	96 Test	38220090	24,500.00
CLS0839HU	Human Dopamine,DA ELISA Kit	96 Test	38220090	24,500.00
CLS0840HU	Human cytochrome P450 2E1,CYP2E1 ELISA Kit	96 Test	38220090	24,500.00
CLS0841HU	Human Hemoglobin (HB)ELISA kit	96 Test	38220090	24,500.00
CLS0842HU	Human heme oxygenase 2,HO-2 ELISA Kit	96 Test	38220090	24,500.00
CLS0843HU	Human matrix metalloproteinase 22(MMP-22)ELISA Kit	96 Test	38220090	24,500.00
CLS0844HU	Human Alpha-methylacyl-CoA recemase(AMACR)ELISA Kit	96 Test	38220090	24,500.00
CLS0845HU	Human Protein Kinase AMP activated alpha 1(PRKAa1)ELISA Kit	96 Test	38220090	24,500.00
CLS0846HU	Human Angiopoietin-like protein 4,ANGPTL4 ELISA Kit	96 Test	38220090	24,500.00
CLS0847HU	Human von Willebrand Factor antigen,vWF:Ag ELISA Kit	96 Test	38220090	24,500.00
CLS0848HU	Human Angiotensin converting enzyme 2,ACE2 ELISA Kit	96 Test	38220090	24,500.00
CLS0849HU	Human Wingless Type MMTV Integration Site Family, Member 10B (WNT10B)ELISA Kit	96 Test	38220090	24,500.00
CLS0850HU	Human Wingless Type MMTV Integration Site Family, Member 5A (WNT5A)ELISA Kit	96 Test	38220090	24,500.00
CLS0851HU	Human Macrophage scavenger receptor 1(MSR1)ELISA Kit	96 Test	38220090	24,500.00
CLS0852HU	Human Somatostatin Receptor 5,SSTR5 ELISA Kit	96 Test	38220090	24,500.00
CLS0853HU	Human Somatostatin Receptor 2,SSTR2 ELISA Kit	96 Test	38220090	24,500.00
CLS0854HU	Human Kallistatin (SERPINA4)ELISA Kit	96 Test	38220090	24,500.00
CLS0855HU	Human SAA/LDL Complex(SAA/LDL Complex)ELISA Kit	96 Test	38220090	24,500.00
CLS0856HU	Human Glucagon-like peptide 2(GLP-2)ELISA Kit	96 Test	38220090	24,500.00
CLS0857HU	Human Visceral adipose-specific serine protease inhibitor,vaspin ELISA Kit	96 Test	38220090	24,500.00
CLS0858HU	Human apoprotein B100,apo-B100 ELISA Kit	96 Test	38220090	24,500.00
CLS0859HU	Human Oxidized low-density lipoprotein receptor 1,OLR1/LOX1 ELISA kit	96 Test	38220090	24,500.00
CLS0860HU	Human Spondin-2(Spondin-2)ELISA Kit	96 Test	38220090	24,500.00
CLS0861HU	Human Apolipoprotein B-48,ApoB48 ELISA Kit	96 Test	38220090	24,500.00
CLS0862HU	Human Interleukin 32,IL-32 ELISA Kit	96 Test	38220090	24,500.00
CLS0863HU	Human Heat Shock Protein 72,HSP-72 ELISA Kit	96 Test	38220090	24,500.00
CLS0864HU	Human Desmosine(DES)ELISA Kit	96 Test	38220090	24,500.00
CLS0865HU	Human Cytochrome P450 1B1(CYP1B1)ELISA Kit	96 Test	38220090	24,500.00
CLS0866HU	human pyridoxal/pyridoxine vitamin B6-phosphatase,PDXP ELISA Kit	96 Test	38220090	24,500.00
CLS0867HU	Human Angiogenin(ANG)ELISA Kit	96 Test	38220090	24,500.00
CLS0868HU	Human Insulin Receptor,INSR ELISA Kit	96 Test	38220090	24,500.00
CLS0869HU	Human plasminogen activator inhibitor 1,PAI-1 ELISA Kit	96 Test	38220090	24,500.00
CLS0870HU	Human Phospholipase A2 Receptor 1 (PLA2R1)ELISA kit	96 Test	38220090	24,500.00
CLS0871HU	Human Slit2(Slit2)ELISA Kit	96 Test	38220090	24,500.00
CLS0872HU	Human Aldo-Keto Reductase Family 1, Member B1(AKR1B1)ELISA Kit	96 Test	38220090	24,500.00
CLS0873HU	Human Aldo-keto reductase family 1 member B10(AKR1B10)ELISA Kit	96 Test	38220090	24,500.00
CLS0874HU	Human Aprotinin,AP ELISA Kit	96 Test	38220090	24,500.00
CLS0875HU	Human platelet Selectin,P-Selectin/CD62P ELISA kit	96 Test	38220090	24,500.00
CLS0876HU	Human Granulins,GRN ELISA KIT	96 Test	38220090	24,500.00
CLS0877HU	Human angiotensin II ,ANG- II ELISA Kit	96 Test	38220090	24,500.00
CLS0878HU	Human anti-ganglioside antibody,GM2 ELISA Kit	96 Test	38220090	24,500.00

Cat.No.	Product Description	Pack Size	HSN	Unit Price
CLS0879HU	Human Interleukin 34,IL-34 ELISA Kit	96 Test	38220090	24,500.00
CLS0880HU	Human fatty acid binding protein 1,FABP1 ELISA Kit	96 Test	38220090	24,500.00
CLS0881HU	Human High Molecular Weight Adiponectin(HMW Adiponectin)ELISA Kit	96 Test	38220090	24,500.00
CLS0882HU	Human apoprotein B,apo-B ELISA Kit	96 Test	38220090	24,500.00
CLS0883HU	Human apoprotein A1,apo-A1 ELISA Kit	96 Test	38220090	24,500.00
CLS0884HU	Human 24(S)-Hydroxycholesterol(24-OHC)ELISA Kit	96 Test	38220090	24,500.00
CLS0885HU	Human glucokinase, GCK ELISA Kit	96 Test	38220090	24,500.00
CLS0886HU	Human Transforming Growth factor beta1,TGF-beta1 ELISA kit	96 Test	38220090	24,500.00
CLS0887HU	Human Apolipoprotein E,Apo-E ELISA Kit	96 Test	38220090	24,500.00
CLS0888HU	Human angiopoietin-like protein 3,ANGPTL3 ELISA Kit	96 Test	38220090	24,500.00
CLS0889HU	Human Angiopoietin-like protein 2,ANGPTL2 ELISA Kit	96 Test	38220090	24,500.00
CLS0890HU	Human triglyceride, TG ELISA Kit	96 Test	38220090	24,500.00
CLS0891HU	Human Deoxypridinoline crosslinks,DPD ELISA Kit	96 Test	38220090	24,500.00
CLS0892HU	Human Thromboxane A2,TX-A2 ELISA Kit	96 Test	38220090	24,500.00
CLS0893HU	Human hepatocyte growth factor receptor,HGFR ELISA Kit	96 Test	38220090	24,500.00
CLS0894HU	Human coagulation factor IX, FIX ELISA Kit	96 Test	38220090	24,500.00
CLS0895HU	Human Heat Shock Protein Beta 2 (HSPb2)ELISA kit	96 Test	38220090	24,500.00
CLS0896HU	Human sphingomyelin, SM ELISA Kit	96 Test	38220090	24,500.00
CLS0897HU	Human anti-streptolysin O,ASO ELISA Kit	96 Test	38220090	24,500.00
CLS0898HU	Human Defensin Beta 103 (DEFb103)ELISA Kit	96 Test	38220090	24,500.00
CLS0899HU	Human lysophosphatidic acid(LPA)ELISA Kit	96 Test	38220090	24,500.00
CLS0900HU	Human Histone deacetylase 1,HDAC1 ELISA KIT	96 Test	38220090	24,500.00
CLS0901HU	Human soluble Factor-related Apoptosis ligand,sFASL/Apo-1 ELISA Kit	96 Test	38220090	24,500.00
CLS0902HU	Human Vitamin D-binding protein,DBP ELISA Kit	96 Test	38220090	24,500.00
CLS0903HU	Human Xaa-Pro Dipeptidase/Prolidase(PEPD)ELISA Kit	96 Test	38220090	24,500.00
CLS0904HU	Human c-Jun N-terminal kinases/stress-activated protein kinase(JNK/SAPK)ELISA Kit	96 Test	38220090	24,500.00
CLS0905HU	Human C-Peptide(C-Peptide)ELISA Kit	96 Test	38220090	24,500.00
CLS0906HU	Human 14-3-3 protein eta(YWHAH)ELISA Kit	96 Test	38220090	24,500.00
CLS0907HU	Human Amine oxidase [flavin-containing] B(MAOB)ELISA Kit	96 Test	38220090	24,500.00
CLS0908HU	Human monoamine oxidase A,MAOA ELISA Kit	96 Test	38220090	24,500.00
CLS0909HU	Human Ki-67 protein,ki67P ELISA kit	96 Test	38220090	24,500.00
CLS0910HU	Human Prominin 2(PROM2)ELISA Kit	96 Test	38220090	24,500.00
CLS0911HU	Human Melanocortin receptor 5(MC5R)ELISA Kit	96 Test	38220090	24,500.00
CLS0912HU	Human Fibroblast Growth Factor 4(FGF4)ELISA Kit	96 Test	38220090	24,500.00
CLS0913HU	Human Lymphotoxin-alpha,LTA ELISA Kit	96 Test	38220090	24,500.00
CLS0914HU	Human Cyclic guanosine monophosphate,cGMP ELISA Kit	96 Test	38220090	24,500.00
CLS0915HU	Human Alpha-Crosslaps(aCTx)ELISA Kit	96 Test	38220090	24,500.00
CLS0916HU	Human Bone-specific alkaline phosphatase(BAP)ELISA Kit	96 Test	38220090	24,500.00
CLS0917HU	Human Caspase 10 (CASP10)ELISA kit	96 Test	38220090	24,500.00
CLS0918HU	human anti-neutrophil cytoplasmic antibody,cANCA ELISA Kit	96 Test	38220090	24,500.00
CLS0919HU	Human Perinuclear anti-neutrophil cytoplasmic antibody,pANCA ELISA Kit	96 Test	38220090	24,500.00
CLS0920HU	Human Myosin light chain 4(MYL4)ELISA Kit	96 Test	38220090	24,500.00
CLS0921HU	Human CD5 antigen-like, CD5L ELISA Kit	96 Test	38220090	24,500.00
CLS0922HU	Human Ig gamma-1 chain C region(IGHG1)ELISA Kit	96 Test	38220090	24,500.00
CLS0923HU	Human Ig gamma-3 chain C region(IGHG3)ELISA Kit	96 Test	38220090	24,500.00
CLS0924HU	Human Immunoglobulin J chain(IGJ)ELISA Kit	96 Test	38220090	24,500.00
CLS0925HU	Human diamine oxidase,DAO ELISA Kit	96 Test	38220090	24,500.00
CLS0926HU	Human Dopamine D1 receptor,D1R ELISA Kit	96 Test	38220090	24,500.00
CLS0927HU	Human aggrecan,Agc ELISA Kit	96 Test	38220090	24,500.00

Cat.No.	Product Description	Pack Size	HSN	Unit Price
CLS0928HU	Human Aflatoxin B1 aldehyde reductase member 4(AKR7L)ELISA Kit	96 Test	38220090	24,500.00
CLS0929HU	Human Galactose-1-phosphate uridylyltransferase(GALT)ELISA Kit	96 Test	38220090	24,500.00
CLS0930HU	Human Proteolysis Inducing Factor/Dermcidin(PIF/DCD)ELISA Kit	96 Test	38220090	24,500.00
CLS0931HU	Human pro-opiomelanocortin(POMC)ELISA Kit	96 Test	38220090	24,500.00
CLS0932HU	Human Squamous Cell Carcinoma Antigen 2,SCCAg 2 ELISA Kit	96 Test	38220090	24,500.00
CLS0933HU	Human Telomerase reverse transcriptase,TERT ELISA Kit	96 Test	38220090	24,500.00
CLS0934HU	Human Insulin Like Protein 3(INSL3) ELISA KIT	96 Test	38220090	24,500.00
CLS0935HU	Human heme oxygenase 1,HO-1 ELISA Kit	96 Test	38220090	24,500.00
CLS0936HU	Human Semaphorin 3B,SEMA3B ELISA kit	96 Test	38220090	24,500.00
CLS0937HU	Human Bone Morphogenetic Protein 3 (BMP3)ELISA kit	96 Test	38220090	24,500.00
CLS0938HU	Human squamous cell carcinoma related antigen,SCCAg ELISA Kit	96 Test	38220090	24,500.00
CLS0939HU	Human 11-dehydro-thromboxane B2,11-DH-TXB2 ELISA Kit	96 Test	38220090	24,500.00
CLS0940HU	Human anti-chorionic gonadotropin-antibody,AhCGAb ELISA Kit	96 Test	38220090	24,500.00
CLS0941HU	Human Very Low Density Lipoprotein(VLDL)ELISA Kit	96 Test	38220090	24,500.00
CLS0942HU	Human Transcription factor 4,TCF-4 ELISA Kit	96 Test	38220090	24,500.00
CLS0943HU	Human Islet Antigen-2 Antibody/Protein-tyrosine phosphatase,IA-2A/PTP ELISA Kit	96 Test	38220090	24,500.00
CLS0944HU	Human zinc transporter 8(ZNT8)ELISA Kit	96 Test	38220090	24,500.00
CLS0945HU	Human Septin-7(SEPT7)ELISA Kit	96 Test	38220090	24,500.00
CLS0946HU	Human Sex Determining Region Y Box Protein 3 (SOX3)ELISA kit	96 Test	38220090	24,500.00
CLS0947HU	Human Transcription factor 7(TCF7)ELISA Kit	96 Test	38220090	24,500.00
CLS0948HU	Human DNA repair protein XRCC1(XRCC1)ELISA Kit	96 Test	38220090	24,500.00
CLS0949HU	Human mycophenolic acid,MPA ELISA Kit	96 Test	38220090	24,500.00
CLS0950HU	Human cellular fibronectin,cFn ELISA kit	96 Test	38220090	24,500.00
CLS0951HU	Human Tyrosine Protein Phosphate non-receptor type 22(PTPN22)ELISA Kit	96 Test	38220090	24,500.00
CLS0952HU	Human granzymes B,Gzms-B ELISA Kit	96 Test	38220090	24,500.00
CLS0953HU	Human Sestrin 1 (SESN1)ELISA kit	96 Test	38220090	24,500.00
CLS0954HU	Human Sestrin 2 (SESN2)ELISA kit	96 Test	38220090	24,500.00
CLS0955HU	Human Sestrin 3 (SESN3)ELISA kit	96 Test	38220090	24,500.00
CLS0956HU	Human Laminin Alpha 4(LAMa4)ELISA Kit	96 Test	38220090	24,500.00
CLS0957HU	Human Nicotinamide N-methyltransferase(NNMT)ELISA Kit	96 Test	38220090	24,500.00
CLS0958HU	Human Low Density Lipoprotein Receptor Related Protein 8 (LRP8)ELISA kit	96 Test	38220090	24,500.00
CLS0959HU	Human melatonin sulfate,MS ELISA Kit	96 Test	38220090	24,500.00
CLS0960HU	Human vesicle-fusing ATPase(NSF)ELISA Kit	96 Test	38220090	24,500.00
CLS0961HU	Human Total protein S,TPS ELISA Kit	96 Test	38220090	24,500.00
CLS0962HU	Human Caspase 4 (CASP4)ELISA kit	96 Test	38220090	24,500.00
CLS0963HU	Human Eosinophil Peroxidase(EPO)ELISA Kit	96 Test	38220090	24,500.00
CLS0964HU	Human matrilysin,MAT ELISA Kit	96 Test	38220090	24,500.00
CLS0965HU	Human Reticulocalbin 1 (RCN1)ELISA Kit	96 Test	38220090	24,500.00
CLS0966HU	Human Reticulocalbin 3 (RCN3)ELISA Kit	96 Test	38220090	24,500.00
CLS0967HU	Human CXC-chemokine ligand 5(CXCL5)ELISA Kit	96 Test	38220090	24,500.00
CLS0968HU	Human Gamma-aminobutyric acid,GABA ELISA Kit	96 Test	38220090	24,500.00
CLS0969HU	Human cystathionine-gamma-lyase,CSE ELISA Kit	96 Test	38220090	24,500.00
CLS0970HU	Human soluble tumor necrosis factor-related apoptosis inducing ligand,sTRAIL ELISA KIT	96 Test	38220090	24,500.00
CLS0971HU	Human a proliferation inducing ligand(APRIL)ELISA Kit	96 Test	38220090	24,500.00
CLS0972HU	Human Cystathionine beta-synthase(CBS)ELISA Kit	96 Test	38220090	24,500.00
CLS0973HU	Human Bromodeoxyuridine,BrdU ELISA Kit	96 Test	38220090	24,500.00

Cat.No.	Product Description	Pack Size	HSN	Unit Price
CLS0974HU	Human Scavenger receptor cysteine-rich type 1 protein M130(C163A)ELISA Kit	96 Test	38220090	24,500.00
CLS0975HU	Human Galectin-3-binding protein(LG3BP)ELISA Kit	96 Test	38220090	24,500.00
CLS0976HU	Human Sulfhydryl oxidase 1(QSOX1)ELISA Kit	96 Test	38220090	24,500.00
CLS0977HU	Human tumor necrosis factor-related apoptosis-inducing ligand receptor 2(TRAIL-R2)ELISA Kit	96 Test	38220090	24,500.00
CLS0978HU	Human Thrombospondin type 1 domain containing protein 7A(THSD7A)ELISA Kit	96 Test	38220090	24,500.00
CLS0979HU	Human melanoma-associated antigen 1,MAGEA1 ELISA Kit	96 Test	38220090	24,500.00
CLS0980HU	Human Prolyl 4-Hydroxylase, alpha Polypeptide I (P4HA1)ELISA Kit	96 Test	38220090	24,500.00
CLS0981HU	Human Microalbumin(MALB)ELISA Kit	96 Test	38220090	24,500.00
CLS0982HU	Human clusterin,CLU ELISA Kit	96 Test	38220090	24,500.00
CLS0983HU	Human 11-Beta-Hydroxysteroid Dehydrogenase Type 2 (11BetaHSD2) ELISA Kit	96 Test	38220090	24,500.00
CLS0984HU	Human Paraoxonase-1,PON1 ELISA Kit	96 Test	38220090	24,500.00
CLS0985HU	Human basic helix-loop-helix family,member e41(SHARP1)ELISA Kit	96 Test	38220090	24,500.00
CLS0986HU	Human E3 ubiquitin protein ligase RNF167(RNF167)ELISA Kit	96 Test	38220090	24,500.00
CLS0987HU	human thyroid stimulating hormone receptor antibody,TRAb ELISA Kit	96 Test	38220090	24,500.00
CLS0988HU	Human Cyclic AMP response element binding protein,CREB ELISA Kit	96 Test	38220090	24,500.00
CLS0989HU	Human Afamin(AFM)ELISA Kit	96 Test	38220090	24,500.00
CLS0990HU	Human Hyperglycosylated chorionic gonadotropin(hCG-H)ELISA Kit	96 Test	38220090	24,500.00
CLS0991HU	Human angiotensin IV,ANG-IV ELISA Kit	96 Test	38220090	24,500.00
CLS0992HU	Human Insulin antibody (ICA)ELISA Kit	96 Test	38220090	24,500.00
CLS0993HU	Human Selenoprotein T(SELT)ELISA Kit	96 Test	38220090	24,500.00
CLS0994HU	Human Acid ceramidase(ASAH1)ELISA Kit	96 Test	38220090	24,500.00
CLS0995HU	Human Selenoprotein W(SEPW1)ELISA Kit	96 Test	38220090	24,500.00
CLS0996HU	Human A Disintegrin and Metalloproteinase with Thrombospondin Motifs 2(ADAMTS2)ELISA Kit	96 Test	38220090	24,500.00
CLS0997HU	Human A Disintegrin and Metalloproteinase with Thrombospondin Motifs 3(ADAMTS3)ELISA Kit	96 Test	38220090	24,500.00
CLS0998HU	Human A Disintegrin and Metalloproteinase with Thrombospondin Motifs 6(ADAMTS6)ELISA Kit	96 Test	38220090	24,500.00
CLS0999HU	Human a disintegrin and metalloproteinase with thrombospondin motifs 7,ADAMTS7 ELISA kit	96 Test	38220090	24,500.00
CLS1000HU	Human A Disintegrin and Metalloproteinase with Thrombospondin Motifs 8(ADAMTS8)ELISA Kit	96 Test	38220090	24,500.00
CLS1001HU	Human A Disintegrin and Metalloproteinase with Thrombospondin Motifs 10(ADAMTS10)ELISA Kit	96 Test	38220090	24,500.00
CLS1002HU	Human A Disintegrin and Metalloproteinase with Thrombospondin Motifs 11(ADAMTS11)ELISA Kit	96 Test	38220090	24,500.00
CLS1003HU	Human A Disintegrin and Metalloproteinase with Thrombospondin Motifs 13(ADAMTS13)ELISA Kit	96 Test	38220090	24,500.00
CLS1004HU	Human A Disintegrin and Metalloproteinase with Thrombospondin Motifs 14(ADAMTS14)ELISA Kit	96 Test	38220090	24,500.00
CLS1005HU	Human A Disintegrin and Metalloproteinase with Thrombospondin Motifs 15(ADAMTS15)ELISA Kit	96 Test	38220090	24,500.00
CLS1006HU	Human A Disintegrin and Metalloproteinase with Thrombospondin Motifs 16(ADAMTS16)ELISA Kit	96 Test	38220090	24,500.00
CLS1007HU	Human A Disintegrin and Metalloproteinase with Thrombospondin Motifs 17(ADAMTS17)ELISA Kit	96 Test	38220090	24,500.00
CLS1008HU	Human A Disintegrin and Metalloproteinase with Thrombospondin Motifs 19(ADAMTS19)ELISA Kit	96 Test	38220090	24,500.00
CLS1009HU	Human Glucose transporter 4, GLUT4 ELISA Kit	96 Test	38220090	24,500.00
CLS1010HU	Human Glucose transporter 1, GLUT1/SLC2A1 ELISA Kit	96 Test	38220090	24,500.00

Cat.No.	Product Description	Pack Size	HSN	Unit Price
CLS1011HU	Human Nischarin(NISCH)ELISA Kit	96 Test	38220090	24,500.00
CLS1012HU	human tryptophanyl-tRNA synthetase,WARS ELISA Kit	96 Test	38220090	24,500.00
CLS1013HU	Human Apolipoprotein B100(APOB100)ELISA KIT	96 Test	38220090	24,500.00
CLS1014HU	Human platelet factor 3, PF3 ELISA Kit	96 Test	38220090	24,500.00
CLS1015HU	Human Glutamyl Aminopeptidase(GLUAP)ELISA Kit	96 Test	38220090	24,500.00
CLS1016HU	Human Superoxide Dismutase 2, Mitochondrial (SOD2)ELISA Kit	96 Test	38220090	24,500.00
CLS1017HU	Human CXC-chemokine receptor 12(CXCR12)ELISA Kit	96 Test	38220090	24,500.00
CLS1018HU	Human Sorting Nexin 1 (SNX1)ELISA Kit	96 Test	38220090	24,500.00
CLS1019HU	Human Transcription factor-like 5 protein,TCFL5/E2BP1 ELISA Kit	96 Test	38220090	24,500.00
CLS1020HU	human Super Oxidase Dimutase 1,SOD-1 ELISA kit	96 Test	38220090	24,500.00
CLS1021HU	Human Collagen,type I ,alpha 1(COL1A1)ELISA Kit	96 Test	38220090	24,500.00
CLS1022HU	Human Collagen,type V ,alpha 1(COL5A1)ELISA Kit	96 Test	38220090	24,500.00
CLS1023HU	Human Collagen,typeXII,alpha 1(COL12A1)ELISA Kit	96 Test	38220090	24,500.00
CLS1024HU	Human Ghrelin(GHRL) ELISA Kit	96 Test	38220090	24,500.00
CLS1025HU	Human Anti-nuclear Antibody,ANA ELISA Kit	96 Test	38220090	24,500.00
CLS1026HU	Human Complement Factor I (CF I)ELISA Kit	96 Test	38220090	24,500.00
CLS1027HU	Human beta-hexosaminidase A,beta-Hex A ELISA Kit	96 Test	38220090	24,500.00
CLS1028HU	Human Aldose reductase(AR)ELISA Kit	96 Test	38220090	24,500.00
CLS1029HU	Human intrinsic factor antibody,IFA ELISA Kit	96 Test	38220090	24,500.00
CLS1030HU	Human D-Lactate Dehydrogenase,D-LDH ELISA Kit	96 Test	38220090	24,500.00
CLS1031HU	Human glutamic acid decarboxylase 65,GAD65 ELISA Kit	96 Test	38220090	24,500.00
CLS1032HU	Human Trefoil factor 3(TFF3)ELISA Kit	96 Test	38220090	24,500.00
CLS1033HU	Human NFKB Repressing Factor(NKRF)ELISA Kit	96 Test	38220090	24,500.00
CLS1034HU	Human Spexin(C12orf39)ELISA Kit	96 Test	38220090	24,500.00
CLS1035HU	Human Peroxisome Proliferator Activated Receptor Delta(PPARd)ELISA Kit	96 Test	38220090	24,500.00
CLS1036HU	Human Peroxisome proliferator-activated receptor gamma coactivator 1 alpha(PGC1alpha)ELISA Kit	96 Test	38220090	24,500.00
CLS1037HU	Human Peroxisome proliferator-activated receptor gamma coactivator 1 beta(PGC1beta)ELISA Kit	96 Test	38220090	24,500.00
CLS1038HU	Human Hypoxia-inducible factor 1-alpha inhibitor,HIF1AN ELISA Kit	96 Test	38220090	24,500.00
CLS1039HU	Human anti-apolipoprotein A1 antibody(anti-Apo-A1)ELISA Kit	96 Test	38220090	24,500.00
CLS1040HU	Human Interleukin 14(IL-14)ELISA Kit	96 Test	38220090	24,500.00
CLS1041HU	Human Semaphorin 3A (SEMA3A)ELISA Kit	96 Test	38220090	24,500.00
CLS1042HU	Human midregional pro-atrial natriuretic peptide(MR-proANP)ELISA Kit	96 Test	38220090	24,500.00
CLS1043HU	Human Cluster of differentiation 40 ligand(CD40L)ELISA Kit	96 Test	38220090	24,500.00
CLS1044HU	Human Kallikrein 3/PSA(KLK3) Elisa kit	96 Test	38220090	24,500.00
CLS1045HU	Human Thrombin, TM ELISA Kit	96 Test	38220090	24,500.00
CLS1046HU	Human Nitrotyrosine(NT)ELISA Kit	96 Test	38220090	24,500.00
CLS1047HU	Human alpha-Hydroxybutyrate Dehydrogenase,alpha-HBDH ELISA Kit	96 Test	38220090	24,500.00
CLS1048HU	Human 1,5-anhydroglucitol,1,5-AG ELISA Kit	96 Test	38220090	24,500.00
CLS1049HU	Human Bone Morphogenetic Protein 7 (BMP7)ELISA kit	96 Test	38220090	24,500.00
CLS1050HU	Human Mucin-1,MUC1 ELISA Kit	96 Test	38220090	24,500.00
CLS1051HU	Human Testican I (TIC I)ELISA Kit	96 Test	38220090	24,500.00
CLS1052HU	Human Angiopoietin 1,ANG-1 ELISA Kit	96 Test	38220090	24,500.00
CLS1053HU	human Beta-Endorphin,Beta-EP ELISA Kit	96 Test	38220090	24,500.00
CLS1054HU	Human Tenascin-N(TNN)ELISA Kit	96 Test	38220090	24,500.00
CLS1055HU	Human heat stable antigen(HSA/CD24)ELISA Kit	96 Test	38220090	24,500.00
CLS1056HU	Human Integrin alpha2Beta2(ITG alpha2Beta2)ELISA Kit	96 Test	38220090	24,500.00
CLS1057HU	Human Twist-related protein 1(TWIST1)ELISA Kit	96 Test	38220090	24,500.00
CLS1058HU	Human Twist-related protein 2(TWIST2)ELISA Kit	96 Test	38220090	24,500.00
CLS1059HU	Human Zinc finger E-box-binding homeobox 2(ZEB2)ELISA Kit	96 Test	38220090	24,500.00

Cat.No.	Product Description	Pack Size	HSN	Unit Price
CLS1060HU	Human Tissue factor,IF ELISA Kit	96 Test	38220090	24,500.00
CLS1061HU	Human T cell receptor alphaBeta,TCRalphaBeta ELISA Kit	96 Test	38220090	24,500.00
CLS1062HU	Human Mu-type opioid receptor(OPRM1)ELISA Kit	96 Test	38220090	24,500.00
CLS1063HU	Human Vitamin K1,VK1 ELISA Kit	96 Test	38220090	24,500.00
CLS1064HU	Human phosphatidylglycerol(PG)ELISA Kit	96 Test	38220090	24,500.00
CLS1065HU	Human Complement Receptor 1/Erythrocyte(CR1)ELISA Kit	96 Test	38220090	24,500.00
CLS1066HU	Human Pyridinoline,PYD ELISA Kit	96 Test	38220090	24,500.00
CLS1067HU	Human CXC-chemokine ligand 12(CXCL12)ELISA Kit	96 Test	38220090	24,500.00
CLS1068HU	Human Stromal cell derived factor 1alpha,SDF-1alpha ELISA Kit	96 Test	38220090	24,500.00
CLS1069HU	Human C-X-C motif chemokine 14(CXCL14)ELISA Kit	96 Test	38220090	24,500.00
CLS1070HU	Human alpha2-Antiplasmin,alpha2-AP ELISA Kit	96 Test	38220090	24,500.00
CLS1071HU	Human Fibrin,Fib ELISA Kit	96 Test	38220090	24,500.00
CLS1072HU	Human Beta-synuclein(SNCB)ELISA Kit	96 Test	38220090	24,500.00
CLS1073HU	Human Dynein heavy chain 5,axonemal(DNAH5)ELISA Kit	96 Test	38220090	24,500.00
CLS1074HU	Human lipoprotein alpha,Lp-alpha ELISA Kit	96 Test	38220090	24,500.00
CLS1075HU	Human Mullerian Inhibiting Substance/Anti-Mullerian hormone,MIS/AMH ELISA Kit	96 Test	38220090	24,500.00
CLS1076HU	Human Pepsinogen I (PG I)ELISA Kit	96 Test	38220090	24,500.00
CLS1077HU	Human Pepsinogen II (PG II)ELISA Kit	96 Test	38220090	24,500.00
CLS1078HU	Human O6-methylguanine-DNA methyltransferase,MGMT ELISA Kit	96 Test	38220090	24,500.00
CLS1079HU	Human Squamous Cell Carcinoma Antigen 1(SCCAg1)ELISA Kit	96 Test	38220090	24,500.00
CLS1080HU	Human insulin-like growth factors 1 receptor,IGF-1R ELISA Kit	96 Test	38220090	24,500.00
CLS1081HU	Human Chloride Channel Accessory 1 (CLCA1)ELISA Kit	96 Test	38220090	24,500.00
CLS1082HU	Human Eicosapentaenoic acid(EPA)ELISA Kit	96 Test	38220090	24,500.00
CLS1083HU	Human Orosomucoid 2,ORM2 ELISA Kit	96 Test	38220090	24,500.00
CLS1084HU	Human Phosphatidylinositol-3,4,5-trisphosphate 3-phosphatase and dual-specificity protein phosphatase PTEN,PTEN ELISA kit	96 Test	38220090	24,500.00
CLS1085HU	Human Fibroblast Growth Factor 19 ,FGF19 ELISA Kit	96 Test	38220090	24,500.00
CLS1086HU	Human Structural maintenance of chromosomes protein 3(SMC3)ELISA Kit	96 Test	38220090	24,500.00
CLS1087HU	Human alpha1-Acid glycoprotein,alpha1-AGP ELISA Kit	96 Test	38220090	24,500.00
CLS1088HU	Human melanocyte stimulating hormone,MSH ELISA Kit	96 Test	38220090	24,500.00
CLS1089HU	Human Apelin ,AP ELISA Kit	96 Test	38220090	24,500.00
CLS1090HU	Human Steroid 5-Alpha-Reductase 2(SRD5A2)ELISA Kit	96 Test	38220090	24,500.00
CLS1091HU	Human Aquaporin 1,AQP-1 ELISA Kit	96 Test	38220090	24,500.00
CLS1092HU	Human Aquaporin 2,AQP-2 ELISA Kit	96 Test	38220090	24,500.00
CLS1093HU	Human Aquaporin 3,AQP-3 ELISA Kit	96 Test	38220090	24,500.00
CLS1094HU	Human Stress Induced Phosphoprotein 1 (STIP1)ELISA kit	96 Test	38220090	24,500.00
CLS1095HU	Human Keratin 17(KRT17)ELISA Kit	96 Test	38220090	24,500.00
CLS1096HU	Human Class E basic helix-loop-helix protein 41(BHLHE41)ELISA Kit	96 Test	38220090	24,500.00
CLS1097HU	Human Pleckstrin homology domain-containing family H member 3(PLEKHH3) Elisa kit	96 Test	38220090	24,500.00
CLS1098HU	Human Cytochrome P450 3A5(CYP3A5)ELISA Kit	96 Test	38220090	24,500.00
CLS1099HU	Human Methylmalonate-semialdehyde dehydrogenase[acylating],mitochondrial(ALDH6A1)ELIS A Kit	96 Test	38220090	24,500.00
CLS1100HU	Human Alcohol dehydrogenase 6(ADH6)ELISA Kit	96 Test	38220090	24,500.00
CLS1101HU	Human Phosphodiesterase 9A(PDE9A)ELISA Kit	96 Test	38220090	24,500.00
CLS1102HU	Human Myogenic Differentiation(MyoD)ELISA Kit	96 Test	38220090	24,500.00
CLS1103HU	Human Sialic acid,SA ELISA Kit	96 Test	38220090	24,500.00
CLS1104HU	Human HtrA Serine Peptidase 1 (HTRA1)ELISA Kit	96 Test	38220090	24,500.00

Cat.No.	Product Description	Pack Size	HSN	Unit Price
CLS1105HU	Human Soluble Intercellular Adhesion Molecule-1,sICAM 1 ELISA Kit	96 Test	38220090	24,500.00
CLS1106HU	Human Follicle Stimulating Hormone Receptor(FSHR)ELISA Kit	96 Test	38220090	24,500.00
CLS1107HU	Human glutaminc-oxaloacetic transaminase(GOT)ELISA Kit	96 Test	38220090	24,500.00
CLS1108HU	Human Glutamic Pyruvic Transaminase(GPT)ELISA Kit	96 Test	38220090	24,500.00
CLS1109HU	Human total bilirubin(TB)ELISA Kit	96 Test	38220090	24,500.00
CLS1110HU	Human glucose oxidase,GOD ELISA Kit	96 Test	38220090	24,500.00
CLS1111HU	Human C Terminal agrin(CTA)ELISA Kit	96 Test	38220090	24,500.00
CLS1112HU	Human Protein kinase A,PKA ELISA Kit	96 Test	38220090	24,500.00
CLS1113HU	Human Beta-Crosslaps(Beta-CTX)ELISA Kit	96 Test	38220090	24,500.00
CLS1114HU	Human cytotoxic T lymphocyte associated antigen 4,CTLA-4 ELISA Kit	96 Test	38220090	24,500.00
CLS1115HU	human gonadotropin-releasing hormone,GnRH ELISA Kit	96 Test	38220090	24,500.00
CLS1116HU	Human Periostin,POSTN ELISA kit	96 Test	38220090	24,500.00
CLS1117HU	Human Phosphodiesterase 4B, cAMP Specific(PDE4B)ELISA Kit	96 Test	38220090	24,500.00
CLS1118HU	Human plasminogen activator,PLGA ELISA Kit	96 Test	38220090	24,500.00
CLS1119HU	Human NLR Family, CARD Domain Containing 4(NLRC4)ELISA Kit	96 Test	38220090	24,500.00
CLS1120HU	Human Histone deacetylase 3(HDAC3)ELISA Kit	96 Test	38220090	24,500.00
CLS1121HU	Human Protein FAM132A(FAM132A)ELISA Kit	96 Test	38220090	24,500.00
CLS1122HU	human Neuregulin 1,NRG-1 ELISA Kit	96 Test	38220090	24,500.00
CLS1123HU	Human cholecystokinin octapeptide,CCK-8 ELISA Kit	96 Test	38220090	24,500.00
CLS1124HU	Human fibroblast growth factor receptor 1(FGFR1)ELISA Kit	96 Test	38220090	24,500.00
CLS1125HU	Human Fatty acid synthase(FAS)ELISA Kit	96 Test	38220090	24,500.00
CLS1126HU	Human Lung specific X protein(LUNX)ELISA Kit	96 Test	38220090	24,500.00
CLS1127HU	Human Total Thyroxine(TT4)ELISA Kit	96 Test	38220090	24,500.00
CLS1128HU	Human Rapamycin insensitive companion of mTOR(RICTOR)ELISA Kit	96 Test	38220090	24,500.00
CLS1129HU	Human Glycated Albumin,GA ELISA Kit	96 Test	38220090	24,500.00
CLS1130HU	Human Poly [ADP-ribose] polymerase 1(PARP1)ELISA Kit	96 Test	38220090	24,500.00
CLS1131HU	Human Interferon stimulated gene 15,ISG15 ELISA Kit	96 Test	38220090	24,500.00
CLS1132HU	Human Antigen KI-67 (KI-67)ELISA Kit	96 Test	38220090	24,500.00
CLS1133HU	Human C4 binding protein,C4BP ELISA Kit	96 Test	38220090	24,500.00
CLS1134HU	Human Sclerostin(SOST)ELISA Kit	96 Test	38220090	24,500.00
CLS1135HU	Human fetal Fibronectin(fFN)ELISA Kit	96 Test	38220090	24,500.00
CLS1136HU	Human Surfactant protein defirition(SPDP)ELISA Kit	96 Test	38220090	24,500.00
CLS1137HU	Human Achaete-scute homolog 1(ASCL1)ELISA Kit	96 Test	38220090	24,500.00
CLS1138HU	Human mitogen activited protein kinase1,MAPK1/MAPK ELISA Kit	96 Test	38220090	24,500.00
CLS1139HU	Human Copeptin(CPP)ELISA Kit	96 Test	38220090	24,500.00
CLS1140HU	Human CC-chemokine receptor 2(CCR-2)ELISA Kit	96 Test	38220090	24,500.00
CLS1141HU	Human CC-chemokine receptor 5(CCR-5)ELISA Kit	96 Test	38220090	24,500.00
CLS1142HU	Human N-Terminal Propeptide of type 1 collagen(P I NP)ELISA Kit	96 Test	38220090	24,500.00
CLS1143HU	Human C-Terminal telopeptide of type 1 collagen(B-CTX)ELISA Kit	96 Test	38220090	24,500.00
CLS1144HU	Human prostate specific antigen(Pro-PSA)ELISA Kit	96 Test	38220090	24,500.00
CLS1145HU	Human Complement 3,C3 ELISA Kit	96 Test	38220090	24,500.00
CLS1146HU	Human Complement 4,C4 ELISA Kit	96 Test	38220090	24,500.00
CLS1147HU	Human cyclooxygenase-1,COX-1 ELISA Kit	96 Test	38220090	24,500.00
CLS1148HU	Human cyclooxygenase-2,COX-2 ELISA Kit	96 Test	38220090	24,500.00
CLS1149HU	Human nitric oxide synthase,NOS ELISA Kit	96 Test	38220090	24,500.00
CLS1150HU	Human 1,25-dihydroxyvitamin D3,DVD/DHVD3 ELISA Kit	96 Test	38220090	24,500.00
CLS1151HU	Human apelin 12,AP12 ELISA Kit	96 Test	38220090	24,500.00
CLS1152HU	Human golgi protein 73,GP-73 ELISA Kit	96 Test	38220090	24,500.00
CLS1153HU	Human Polycomb complex protein BMI-1(BMI1)ELISA Kit	96 Test	38220090	24,500.00

Cat.No.	Product Description	Pack Size	HSN	Unit Price
CLS1154HU	Human DNA topoisomerase 1(TOP1)ELISA Kit	96 Test	38220090	24,500.00
CLS1155HU	Human von Willebrand Factor cleaving protease,ADAMTS-13/vWF-cp ELISA Kit	96 Test	38220090	24,500.00
CLS1156HU	Human 25-Dihydroxy vitamin D3,HVD3 ELISA Kit	96 Test	38220090	24,500.00
CLS1157HU	Human Filaggrin (FLG)ELISA Kit	96 Test	38220090	24,500.00
CLS1158HU	Human UDP-glucumno-syltransferase 1(UGT1)ELISA Kit	96 Test	38220090	24,500.00
CLS1159HU	Human Granulocyte Colony Stimulating Factor,G-CSF ELISA Kit	96 Test	38220090	24,500.00
CLS1160HU	Human Bcl2/Adenovirus E1B 19kDa Interacting Protein 3 (BNIP3)ELISA Kit	96 Test	38220090	24,500.00
CLS1161HU	Human Claudin 2 (CLDN2)ELISA kit	96 Test	38220090	24,500.00
CLS1162HU	Human Neonatal Thyroid Stimulating Hormone,N-TSH ELISA Kit	96 Test	38220090	24,500.00
CLS1163HU	Human Platelet-Derived Growth Factor-B,PDGF-B ELISA kit	96 Test	38220090	24,500.00
CLS1164HU	Human Apoprotein A(APO-A)ELISA Kit	96 Test	38220090	24,500.00
CLS1165HU	Human Ultra Sensitive Prostate Specific Antigen,PSAUS ELISA Kit	96 Test	38220090	24,500.00
CLS1166HU	Human 2,5-oligoadenylate synthetase(2,5-OAS) ELISA Kit	96 Test	38220090	24,500.00
CLS1167HU	Human Heat Shock 70kDa Protein 5 (HSPA5)ELISA kit	96 Test	38220090	24,500.00
CLS1168HU	Human Interferon alpha-2,IFNA2 ELISA Kit	96 Test	38220090	24,500.00
CLS1169HU	Human Pancreatic secretory trypsin inhibitor(SPINK1)ELISA Kit	96 Test	38220090	24,500.00
CLS1170HU	Human Cluster of differentiation 200(CD200)ELISA Kit	96 Test	38220090	24,500.00
CLS1171HU	Human Prostaglandin E Metabolite(PGEM)ELISA Kit	96 Test	38220090	24,500.00
CLS1172HU	Human total oxidant status(TOS)ELISA Kit	96 Test	38220090	24,500.00
CLS1173HU	Human Copine I (CPNE1)ELISA Kit	96 Test	38220090	24,500.00
CLS1174HU	Human Heat Shock Protein 70,HSP-70 ELISA Kit	96 Test	38220090	24,500.00
CLS1175HU	Human protein disulfide-isomerase A3,PDIA3 ELISA Kit	96 Test	38220090	24,500.00
CLS1176HU	Human Cathepsin B,cath-B ELISA Kit	96 Test	38220090	24,500.00
CLS1177HU	Human alpha1-Antitrypsin,alpha1-AT ELISA Kit	96 Test	38220090	24,500.00
CLS1178HU	Human Interleukin 35,IL-35 ELISA Kit	96 Test	38220090	24,500.00
CLS1179HU	Human thrombomodulin,TM ELISA Kit	96 Test	38220090	24,500.00
CLS1180HU	Human endotoxin,ET ELISA Kit	96 Test	38220090	24,500.00
CLS1181HU	Human Glucose Regulated Protein 78(GRP78)ELISA Kit	96 Test	38220090	24,500.00
CLS1182HU	Human Collagen Type I ,Col I ELISA Kit	96 Test	38220090	24,500.00
CLS1183HU	Human Osteocalcin/Bone gla protein,OT/BGP ELISA kit	96 Test	38220090	24,500.00
CLS1184HU	Human Osteoprotegerin,OPG ELISA KIT	96 Test	38220090	24,500.00
CLS1185HU	Human receptor activator of nuclear factor kappa B ligand,RANKL ELISA Kit	96 Test	38220090	24,500.00
CLS1186HU	Human Anoctamin 1 (ANO1)ELISA Kit	96 Test	38220090	24,500.00
CLS1187HU	Human F-box only protein 32,FBXO32/MAFbx ELISA Kit	96 Test	38220090	24,500.00
CLS1188HU	Human Basic Salivary Proline Rich Protein 2(PRB2)ELISA Kit	96 Test	38220090	24,500.00
CLS1189HU	Human Basic Salivary Proline Rich Protein 1(PRB1)ELISA Kit	96 Test	38220090	24,500.00
CLS1190HU	Human protein tyrosine phosphatase,non-receptor type 6(PTPN6)ELISA Kit	96 Test	38220090	24,500.00
CLS1191HU	Human soluble cluster of differentiation 137(sCD137)ELISA Kit	96 Test	38220090	24,500.00
CLS1192HU	Human Ultra Sensitive growth hormone,US-GH ELISA Kit	96 Test	38220090	24,500.00
CLS1193HU	Human Low Density Lipoprotein Receptor Related Protein 2(LRP2)ELISA Kit	96 Test	38220090	24,500.00
CLS1194HU	Human Transmembrane emp24 domain-containing protein 4(TMED4)ELISA Kit	96 Test	38220090	24,500.00
CLS1195HU	Human Cluster of differentiation 36(CD36)ELISA Kit	96 Test	38220090	24,500.00
CLS1196HU	Human Glycosaminoglycans(GAGs)ELISA Kit	96 Test	38220090	24,500.00
CLS1197HU	Human Fatty Acid Transport Protein 1(FATP1)ELISA Kit	96 Test	38220090	24,500.00
CLS1198HU	Human Fatty Acid Transport Protein 5(FATP5)ELISA Kit	96 Test	38220090	24,500.00

Cat.No.	Product Description	Pack Size	HSN	Unit Price
CLS1199HU	Human Hypoxanthine-guanine phosphoribosyltransferase(HPRT1)ELISA Kit	96 Test	38220090	24,500.00
CLS1200HU	Human Hedgehog Homolog, Indian (IHH)ELISA Kit	96 Test	38220090	24,500.00
CLS1201HU	Human Hedgehog Homolog, Desert (DHH)ELISA Kit	96 Test	38220090	24,500.00
CLS1202HU	Human soluble tumor necrosis factor receptor 1,sTNF-R1 ELISA Kit	96 Test	38220090	24,500.00
CLS1203HU	Human Aquaporin 9(AQP-9)ELISA Kit	96 Test	38220090	24,500.00
CLS1204HU	Human Thiobarbituric Acid Reactive Substance(TBARS)ELISA Kit	96 Test	38220090	24,500.00
CLS1205HU	Human glucocorticoid(GC)ELISA Kit	96 Test	38220090	24,500.00
CLS1206HU	Human Alpha-1B-glycoprotein,A1BG ELISA Kit	96 Test	38220090	24,500.00
CLS1207HU	Human Alpha-2-HS-glycoprotein(AHSG)ELISA Kit	96 Test	38220090	24,500.00
CLS1208HU	Human Vascular Endothelial cell Growth Factor,VEGF ELISA KIT	96 Test	38220090	24,500.00
CLS1209HU	Human Soluble Vascular Endothelial Growth Factor Receptor 1,sFlt-1/sVEGFR-1 ELISA Kit	96 Test	38220090	24,500.00
CLS1210HU	Human Interleukin 8,IL-8 ELISA KIT	96 Test	38220090	24,500.00
CLS1211HU	Human Toll-like receptor 3,TLR3 ELISA Kit	96 Test	38220090	24,500.00
CLS1212HU	Human soluble vascular endothelial growth factor receptor-2,sVEGFR-2/sFLK-1 ELISA Kit	96 Test	38220090	24,500.00
CLS1213HU	Human tissue inhibitors of metalloproteinase 3,TIMP-3 ELISA Kit	96 Test	38220090	24,500.00
CLS1214HU	Human Involucrin,iNV ELISA Kit	96 Test	38220090	24,500.00
CLS1215HU	Human tissue inhibitors of metalloproteinase 4,TIMP-4 ELISA Kit	96 Test	38220090	24,500.00
CLS1216HU	Human Keratin,type II cytoskeletal 1(KRT1)ELISA Kit	96 Test	38220090	24,500.00
CLS1217HU	Human Apolipoprotein A2(apo-A2)ELISA Kit	96 Test	38220090	24,500.00
CLS1218HU	Human beta2-Glycoprotein 1 Antibody IgM,beta2-GP1 Ab IgM ELISA Kit	96 Test	38220090	24,500.00
CLS1219HU	Human small nuclear ribonucleoprotein,snRNP/Sm ELISA Kit	96 Test	38220090	24,500.00
CLS1220HU	Human liver kidney microsome autoantibody,LKM ELISA Kit	96 Test	38220090	24,500.00
CLS1221HU	Human Thyroglobulin,TG ELISA Kit	96 Test	38220090	24,500.00
CLS1222HU	Human Cytochrome P450c21/21-hydroxylase,CYP21A ELISA Kit	96 Test	38220090	24,500.00
CLS1223HU	Human anti-myelin antibody IgA,AMA IgA ELISA Kit	96 Test	38220090	24,500.00
CLS1224HU	Human anti-myelin associated glycoprotein antibody,MAG Ab ELISA Kit	96 Test	38220090	24,500.00
CLS1225HU	Human Talin-1(Talin-1)ELISA Kit	96 Test	38220090	24,500.00
CLS1226HU	Human Optineurin(OPTN)ELISA Kit	96 Test	38220090	24,500.00
CLS1227HU	Human Nuclear Mitotic Apparatus Protein 1,NUMA1 ELISA Kit	96 Test	38220090	24,500.00
CLS1228HU	Human Methylcytosine dioxygenase TET2(TET2)ELISA Kit	96 Test	38220090	24,500.00
CLS1229HU	Human Insulin-like growth factor binding protein 6(IGFBP-6)ELISA Kit	96 Test	38220090	24,500.00
CLS1230HU	Human Calmodulin-regulated spectrin-associated protein 2(CAMSAP1L1)ELISA Kit	96 Test	38220090	24,500.00
CLS1231HU	Human GRIP and coiled-coil domain-containing protein 2(GCC2)ELISA Kit	96 Test	38220090	24,500.00
CLS1232HU	Human Transketolase(TKT)ELISA Kit	96 Test	38220090	24,500.00
CLS1233HU	Human Fermitin family homolog 2(FERM2)ELISA Kit	96 Test	38220090	24,500.00
CLS1234HU	Human procollagen III N-terminal peptide,P III NT ELISA Kit	96 Test	38220090	24,500.00
CLS1235HU	Human Mannan binding protein/mannan binding lectin,MBP/MBL ELISA Kit	96 Test	38220090	24,500.00
CLS1236HU	Human Cluster of Differentiation 8a(CD8a)ELISA Kit	96 Test	38220090	24,500.00
CLS1237HU	Human Leukotriene A4(LT-A4)ELISA Kit	96 Test	38220090	24,500.00
CLS1238HU	Human SH3 domain-containing YSC84-like protein 1(SH3YL1)ELISA Kit	96 Test	38220090	24,500.00
CLS1239HU	Human Endothelial nitric oxide synthase,eNOS ELISA Kit	96 Test	38220090	24,500.00

Cat.No.	Product Description	Pack Size	HSN	Unit Price
CLS1240HU	Human CAMP-dependent protein kinase catalytic subunit alpha(PRKACA)ELISA Kit	96 Test	38220090	24,500.00
CLS1241HU	Human Sarcolipin(SLN)ELISA Kit	96 Test	38220090	24,500.00
CLS1242HU	Human Peroxiredoxin 1 (PRDX1)ELISA Kit	96 Test	38220090	24,500.00
CLS1243HU	Human Occludin(OCLN)ELISA Kit	96 Test	38220090	24,500.00
CLS1244HU	Human Agrin (C-terminal) (AGRN)ELISA Kit	96 Test	38220090	24,500.00
CLS1245HU	human adrenocorticotrophic hormone,ACTH ELISA Kit	96 Test	38220090	24,500.00
CLS1246HU	Human Tumor necrosis factor soluble receptor I ,TNFsR-I ELISA KIT	96 Test	38220090	24,500.00
CLS1247HU	Human Apolipoprotein O,Apo-O ELISA Kit	96 Test	38220090	24,500.00
CLS1248HU	Human Nicotinamide phosphoribosyltransferase(NAMPT)ELISA Kit	96 Test	38220090	24,500.00
CLS1249HU	Human Retinol binding protein 4,RBP-4 ELISA Kit	96 Test	38220090	24,500.00
CLS1250HU	Human Bcl-2 associated X protein, Bax ELISA Kit	96 Test	38220090	24,500.00
CLS1251HU	Human B-cell leukemia/lymphoma 2,Bcl-2 ELISA Kit	96 Test	38220090	24,500.00
CLS1252HU	Human Elastin,ELN ELISA Kit	96 Test	38220090	24,500.00
CLS1253HU	Human Hyaluronan-binding protein 2(HABP2)ELISA Kit	96 Test	38220090	24,500.00
CLS1254HU	Human Interleukin 18,IL-18 ELISA KIT	96 Test	38220090	24,500.00
CLS1255HU	Human Glutamate oxaloacetate transaminase 1,GOT1 ELISA Kit	96 Test	38220090	24,500.00
CLS1256HU	Human regulated on activation in normal T-cell expressed and secreted/C-C motif chemokine 5(RANTES/CCL5)ELISA Kit	96 Test	38220090	24,500.00
CLS1257HU	Human Acylated ghrelin(AG) ELISA kit	96 Test	38220090	24,500.00
CLS1258HU	Human Hepatoma Derived Growth Factor(HDGF)ELISA Kit	96 Test	38220090	24,500.00
CLS1259HU	Human secreted protein acidic and rich in cysteine,SPARC ELISA Kit	96 Test	38220090	24,500.00
CLS1260HU	Human Chitinase-3-like Protein 1(YKL-40/CHI3L1)ELISA Kit	96 Test	38220090	24,500.00
CLS1261HU	Human Leukocyte Antigen B(HLA-B)ELISA Kit	96 Test	38220090	24,500.00
CLS1262HU	Human Leukocyte Antigen-DR(HLA-DR)ELISA Kit	96 Test	38220090	24,500.00
CLS1263HU	Human complement factor H,CFH ELISA Kit	96 Test	38220090	24,500.00
CLS1264HU	Human Complement component 5,C5 ELISA kit	96 Test	38220090	24,500.00
CLS1265HU	Human Prostaglandin FM(PGFM)ELISA Kit	96 Test	38220090	24,500.00
CLS1266HU	Human Protein jagged-1,JAG1/CD339 ELISA Kit	96 Test	38220090	24,500.00
CLS1267HU	Human Late cornified envelope protein 3B(LCE3B)ELISA Kit	96 Test	38220090	24,500.00
CLS1268HU	Human Protein S100-B(S100B)ELISA Kit	96 Test	38220090	24,500.00
CLS1269HU	Human Immunoglobulin G,IgG ELISA Kit	96 Test	38220090	24,500.00
CLS1270HU	Human Endocrine gland vascular endothelial growth factor,EG-VEGF ELISA Kit	96 Test	38220090	24,500.00
CLS1271HU	Human major histocompatibility complex II ,MHC II/HLA- II ELISA Kit	96 Test	38220090	24,500.00
CLS1272HU	Human Proenkephalin-B(PDYN)ELISA Kit	96 Test	38220090	24,500.00
CLS1273HU	Human Forkhead box protein M1(FOXM1)ELISA Kit	96 Test	38220090	24,500.00
CLS1274HU	Human Protein-tyrosine kinase 6(PTK6)ELISA Kit	96 Test	38220090	24,500.00
CLS1275HU	Human Prostaglandin F2alpha,PGF2alpha ELISA Kit	96 Test	38220090	24,500.00
CLS1276HU	Human leukotriene F4(LT-F4)ELISA Kit	96 Test	38220090	24,500.00
CLS1277HU	Human 6-keto-prostaglandin F1a,6-K-PGF1a ELISA Kit	96 Test	38220090	24,500.00
CLS1278HU	Human Apoprotein A4,apo-A4 ELISA Kit	96 Test	38220090	24,500.00
CLS1279HU	Human connective tissue growth factor,CTGF ELISA Kit	96 Test	38220090	24,500.00
CLS1280HU	Human Macrophage Inflammatory Protein-3alpha,MIP-3alpha ELISA kit	96 Test	38220090	24,500.00
CLS1281HU	Human spleen tyrosine kinase,Syk ELISA Kit	96 Test	38220090	24,500.00
CLS1282HU	Human Anti-Myelin Oligodendrocyte Glycoprotein Anitbody(Anti-MOG)ELISA Kit	96 Test	38220090	24,500.00
CLS1283HU	Human S100 Calcium Binding Protein A14(S100A14)ELISA Kit	96 Test	38220090	24,500.00

Cat.No.	Product Description	Pack Size	HSN	Unit Price
CLS1284HU	Human Programmed Cell Death Protein 1 Ligand 1(PDCD1LG1)ELISA Kit	96 Test	38220090	24,500.00
CLS1285HU	Human B Cell Translocation gene 1(BTG1)ELISA Kit	96 Test	38220090	24,500.00
CLS1286HU	Human neuropeptide Y,NP-Y ELISA Kit	96 Test	38220090	24,500.00
CLS1287HU	Human hormone sensitive lipase,HSL ELISA Kit	96 Test	38220090	24,500.00
CLS1288HU	Human Caspase 5 (CASP5)ELISA kit	96 Test	38220090	24,500.00
CLS1289HU	Human Soluble Cluster of differentiation 40 ligand,sCD40L ELISA Kit	96 Test	38220090	24,500.00
CLS1290HU	Human V-Set Domain Containing T-Cell Activation Inhibitor 1 (VTCN1)ELISA Kit	96 Test	38220090	24,500.00
CLS1291HU	Human Nitric oxide synthase-interacting protein(NOSIP)ELISA Kit	96 Test	38220090	24,500.00
CLS1292HU	Human cluster of differentiation(CD16)ELISA Kit	96 Test	38220090	24,500.00
CLS1293HU	Human cluster of differentiation(CD56)ELISA Kit	96 Test	38220090	24,500.00
CLS1294HU	Human Tryptase Beta 2 (TPSb2)ELISA Kit	96 Test	38220090	24,500.00
CLS1295HU	Human Ras homolog enriched in brain(RHEB)ELISA Kit	96 Test	38220090	24,500.00
CLS1296HU	Human Follistatin-related gene(FLRG)ELISA Kit	96 Test	38220090	24,500.00
CLS1297HU	Human Platelet-derived growth factor subunit A,PDGFA ELISA kit	96 Test	38220090	24,500.00
CLS1298HU	Human Adipolin(AD)ELISA Kit	96 Test	38220090	24,500.00
CLS1299HU	Human Mammalian Target of Rapamycin(mTOR)ELISA Kit	96 Test	38220090	24,500.00
CLS1300HU	Human Ribosomal Protein S6 kinase(S6K)ELISA Kit	96 Test	38220090	24,500.00
CLS1301HU	Human Ciliary Neurotrophic Factor,CNTF ELISA Kit	96 Test	38220090	24,500.00
CLS1302HU	Human Leukocyte esterase(LE)ELISA Kit	96 Test	38220090	24,500.00
CLS1303HU	Human catecholamine,CA ELISA Kit	96 Test	38220090	24,500.00
CLS1304HU	Human Apolipoprotein C3,Apo C3 ELISA Kit	96 Test	38220090	24,500.00
CLS1305HU	Human Glutathione peroxidase(GPX)ELISA Kit	96 Test	38220090	24,500.00
CLS1306HU	Human Metastasis-associated protein MTA1(MTA1)ELISA Kit	96 Test	38220090	24,500.00
CLS1307HU	Human Arginase,Arg ELISA Kit	96 Test	38220090	24,500.00
CLS1308HU	Human Interferon beta 1a(IFNB-1a)ELISA Kit	96 Test	38220090	24,500.00
CLS1309HU	Human Interferon beta 1b(IFNB-1b)ELISA Kit	96 Test	38220090	24,500.00
CLS1310HU	Human Methemoglobin,MHB ELISA Kit	96 Test	38220090	24,500.00
CLS1311HU	Human Cross Linked C-Telopeptide Of Type I Collagen(CTX-I)ELISA Kit	96 Test	38220090	24,500.00
CLS1312HU	Human Cross-Linked C-Terminal Telopeptides of Type II Collagen(CTX-II)ELISA Kit	96 Test	38220090	24,500.00
CLS1313HU	Human Decorin/Bone proteoglycan II(DCN)ELISA Kit	96 Test	38220090	24,500.00
CLS1314HU	Human Ectonucleotide pyrophosphatase/phosphodiesterase family member 1(ENPP1)ELISA Kit	96 Test	38220090	24,500.00
CLS1315HU	Human anti-nucleolus antibody,ANA ELISA Kit	96 Test	38220090	24,500.00
CLS1316HU	Human Parathyroid Hormone Related Protein,PTHrP ELISA Kit	96 Test	38220090	24,500.00
CLS1317HU	Human methotrexate(MTX)ELISA Kit	96 Test	38220090	24,500.00
CLS1318HU	Human Leptin,LEP ELISA kit	96 Test	38220090	24,500.00
CLS1319HU	Human zonulin(zonulin)ELISA Kit	96 Test	38220090	24,500.00
CLS1320HU	Human Indoxyl Sulfate(IS)ELISA Kit	96 Test	38220090	24,500.00
CLS1321HU	Human Amanitin(ANT)ELISA Kit	96 Test	38220090	24,500.00
CLS1322HU	Human Plasminogen Activator,Tissue(tPA)ELISA Kit	96 Test	38220090	24,500.00
CLS1323HU	Human Cluster of differentiation 30,CD30 ELISA Kit	96 Test	38220090	24,500.00
CLS1324HU	Human Alpha1 Antichymotrypsin,AACT ELISA Kit	96 Test	38220090	24,500.00
CLS1325HU	Human Pyruvate Kinase Muscle(M2-PK)ELISA Kit	96 Test	38220090	24,500.00
CLS1326HU	Human cholyglycine,CG ELISA Kit	96 Test	38220090	24,500.00
CLS1327HU	Human Uricase(UOX)ELISA Kit	96 Test	38220090	24,500.00
CLS1328HU	Human Interleukin 10,IL-10 ELISA Kit	96 Test	38220090	24,500.00
CLS1329HU	Human Carbohydrate Antigen 242 (CA242)ELISA kit	96 Test	38220090	24,500.00
CLS1330HU	Human Pancreatic carcinoma markers- CA242(CA242)ELISA Ki ELISA Kit	96 Test	38220090	24,500.00

Cat.No.	Product Description	Pack Size	HSN	Unit Price
CLS1331HU	Human Soluble leukocyte Selectin(sL-Selectin)ELISA Kit	96 Test	38220090	24,500.00
CLS1332HU	Human amyloid precursor protein(APP)ELISA Kit	96 Test	38220090	24,500.00
CLS1333HU	Human Cluster of differentiation 25,CD25 ELISA KIT	96 Test	38220090	24,500.00
CLS1334HU	Human Ribosomal protein S6 kinase beta-1(RPS6KB1)ELISA Kit	96 Test	38220090	24,500.00
CLS1335HU	Human 14-3-3 protein epsilon(YWHAE)ELISA Kit	96 Test	38220090	24,500.00
CLS1336HU	Human Orosomucoid 1,ORM1 ELISA Kit	96 Test	38220090	24,500.00
CLS1337HU	Human Tumor necrosis factor-alpha, TNF-alpha ELISA KIT	96 Test	38220090	24,500.00
CLS1338HU	Human Progesterone induced blocking factor(PIBF)ELISA Kit	96 Test	38220090	24,500.00
CLS1339HU	Human platelet growth factor,PGF ELISA Kit	96 Test	38220090	24,500.00
CLS1340HU	Human anti-hepatitis A virus IgM antibody,anti-HAV ELISA Kit	96 Test	38220090	24,500.00
CLS1341HU	Human Interleukin 16,IL-16 ELISA KIT	96 Test	38220090	24,500.00
CLS1342HU	Human alpha-L-fucosidase,AFU ELISA Kit	96 Test	38220090	24,500.00
CLS1343HU	Human Golgi phosphoprotein 2(GOLPH2)ELISA Kit	96 Test	38220090	24,500.00
CLS1344HU	Human Nuclear factor erythroid 2-related factor 2,NRF2 ELISA kit	96 Test	38220090	24,500.00
CLS1345HU	Human osteonectin,ON ELISA Kit	96 Test	38220090	24,500.00
CLS1346HU	Human Trypsin Like Immunoreactive Protein (TLI) ELISA Kit	96 Test	38220090	24,500.00
CLS1347HU	Human Citrulline(Citrulline)ELISA Kit	96 Test	38220090	24,500.00
CLS1348HU	Human Myelin protein P0(MPZ)ELISA Kit	96 Test	38220090	24,500.00
CLS1349HU	Human apelin 13,AP13 ELISA Kit	96 Test	38220090	24,500.00
CLS1350HU	Human pyruvate kinase,PK ELISA Kit	96 Test	38220090	24,500.00
CLS1351HU	Human Antibacterial protein LL-37,LL-37 ELISA Kit	96 Test	38220090	24,500.00
CLS1352HU	Human Vascular Endothelial cell Growth Factor A,VEGF-A ELISA KIT	96 Test	38220090	24,500.00
CLS1353HU	Human Early prostate cancer antigen(EPCA)ELISA Kit	96 Test	38220090	24,500.00
CLS1354HU	Human skin reactive factor/inflammatory factor,SRF/IF ELISA Kit	96 Test	38220090	24,500.00
CLS1355HU	Human 16-alpha Hydroxyestrogen 1(16-alpha OHE-1)ELISA Kit	96 Test	38220090	24,500.00
CLS1356HU	Human 2-Hydroxyestrogen 1(2-OHE1)ELISA Kit	96 Test	38220090	24,500.00
CLS1357HU	Human Tryptophan Hydroxylase 1(TPH1)ELISA Kit	96 Test	38220090	24,500.00
CLS1358HU	Human Bcl-2-like protein 11(BCL2L11)ELISA Kit	96 Test	38220090	24,500.00
CLS1359HU	Human Pancreatic Lipase,PL/PNLIP ELISA Kit	96 Test	38220090	24,500.00
CLS1360HU	Human pancreaticinogenase,PK ELISA Kit	96 Test	38220090	24,500.00
CLS1361HU	Human Irisin(irisin) ELISA Kit	96 Test	38220090	24,500.00
CLS1362HU	Human angiotensinase ELISA Kit	96 Test	38220090	24,500.00
CLS1363HU	Human 11-keto Testosterone(11-KETO-T) ELISA Kit	96 Test	38220090	24,500.00
CLS1364HU	Human Apolipoprotein C-I(APOC1)ELISA Kit	96 Test	38220090	24,500.00
CLS1365HU	Human bradykinin,BK ELISA Kit	96 Test	38220090	24,500.00
CLS1366HU	Human Plexin A2 (PLXNA2)ELISA Kit	96 Test	38220090	24,500.00
CLS1367HU	Human coagulation factor VIII(FVIII)ELISA Kit	96 Test	38220090	24,500.00
CLS1368HU	Human chemokine (C-C motif) ligand 17(CCL17)ELISA Kit	96 Test	38220090	24,500.00
CLS1369HU	Human Tryptophan Hydroxylase 2(TPH2)ELISA Kit	96 Test	38220090	24,500.00
CLS1370HU	Human Succinate dehydrogenase [ubiquinone] iron-sulfur subunit,mitochondrial(SDHB)ELISA Kit	96 Test	38220090	24,500.00
CLS1371HU	Human Tool Like Receptor 9(TLR9)ELISA Kit	96 Test	38220090	24,500.00
CLS1372HU	Human soluble CD25(sCD25)ELISA Kit	96 Test	38220090	24,500.00
CLS1373HU	Human asymmetrical dimethylarginine,ADMA ELISA Kit	96 Test	38220090	24,500.00
CLS1374HU	human 3-hydroxy-3-methylglutaryl-Coenzyme A synthase 1,HMGCS1 ELISA Kit	96 Test	38220090	24,500.00
CLS1375HU	Human Cornifelin (CNFN)ELISA Kit	96 Test	38220090	24,500.00
CLS1376HU	Human NAD Kinase(NADK)ELISA Kit	96 Test	38220090	24,500.00
CLS1377HU	Human Apolipoprotein C2,ApoC2 ELISA Kit	96 Test	38220090	24,500.00
CLS1378HU	Human Catechol-O-Methyltransferase(COMT)ELISA Kit	96 Test	38220090	24,500.00

Cat.No.	Product Description	Pack Size	HSN	Unit Price
CLS1379HU	Human Vasculoar endothelial cell growth factor receptor 3,VEGFR-3/Flt-4 ELISA Kit	96 Test	38220090	24,500.00
CLS1380HU	Human Amelogenin Linked-X (AMELX)ELISA Kit	96 Test	38220090	24,500.00
CLS1381HU	Human Sarcalumenin (SRL)ELISA Kit	96 Test	38220090	24,500.00
CLS1382HU	Human Integrin beta-3(ITGB3)ELISA Kit	96 Test	38220090	24,500.00
CLS1383HU	Human Integrin alpha-V(ITGAV)ELISA Kit	96 Test	38220090	24,500.00
CLS1384HU	human hemochromatosis type 2/venile-uman homolog,HFE2 LISA Kit	96 Test	38220090	24,500.00
CLS1385HU	Human Transient Receptor Potential Cation Channel Subfamily M,Member 8(TRPM8)ELISA Kit	96 Test	38220090	24,500.00
CLS1386HU	Human Defensin Alpha 1/Neutrophil(DEFa1)ELISA Kit	96 Test	38220090	24,500.00
CLS1387HU	Human Telomere Repeat Binding Factor 2(TRF2)ELISA Kit	96 Test	38220090	24,500.00
CLS1388HU	Human Telomere Repeat Binding Factor 1(TRF1)ELISA Kit	96 Test	38220090	24,500.00
CLS1389HU	Human Myosin Heavy Chain 7, Cardiac Muscle, Beta(MYH7)ELISA Kit	96 Test	38220090	24,500.00
CLS1390HU	Human Transcription Factor/Activator Protein 1(AP-1)ELISA Kit	96 Test	38220090	24,500.00
CLS1391HU	Human remnant lipoprotein cholesterol,RLP-c ELISA Kit	96 Test	38220090	24,500.00
CLS1392HU	Human Fibroblast Factor 10(FGF10)ELISA Kit	96 Test	38220090	24,500.00
CLS1393HU	Human Katalcalcin(PDN-21)ELISA Kit	96 Test	38220090	24,500.00
CLS1394HU	Human ficolin 1,FCN1 ELISA Kit	96 Test	38220090	24,500.00
CLS1395HU	Human neutrophil peptide 1-3,HNP1-3 ELISA Kit	96 Test	38220090	24,500.00
CLS1396HU	Human myosin heavy chain 1(MHC1)ELISA Kit	96 Test	38220090	24,500.00
CLS1397HU	Human myosin heavy chain 2(MHC2)ELISA Kit	96 Test	38220090	24,500.00
CLS1398HU	Human Vascular adhesion protein-1,VAP-1/AOC3 ELISA Kit	96 Test	38220090	24,500.00
CLS1399HU	Human Acyl-CoA desaturase 1(Scd1/Scd)ELISA Kit	96 Test	38220090	24,500.00
CLS1400HU	Human Interferon Gamma Induced Protein 10kDa(IP10)ELISA Kit	96 Test	38220090	24,500.00
CLS1401HU	Human Interleukin 17 Receptor B(IL-17RB)ELISA Kit	96 Test	38220090	24,500.00
CLS1402HU	Human Glutamate decarboxylase 1(GAD1)ELISA Kit	96 Test	38220090	24,500.00
CLS1403HU	Human major histocompatibility complex class I chain-related gene B,MICB ELISA Kit	96 Test	38220090	24,500.00
CLS1404HU	Human Serine/threonine-protein kinase PLK3(PLK3)ELISA Kit	96 Test	38220090	24,500.00
CLS1405HU	Human Cytoplasmic dynein 2 heavy chain 1(DYNC2H1)ELISA Kit	96 Test	38220090	24,500.00
CLS1406HU	Human Tyrosine-protein kinase Fer(FER)ELISA Kit	96 Test	38220090	24,500.00
CLS1407HU	Human 14-3-3 protein gamma(YWHAG)ELISA Kit	96 Test	38220090	24,500.00
CLS1408HU	Human Neurokinins A,NKA ELISA kit	96 Test	38220090	24,500.00
CLS1409HU	Human Interleukin 1beta converting enzyme,Caspase-1/ICE ELISA Kit	96 Test	38220090	24,500.00
CLS1410HU	Human presepsin(PSPN)ELISA Kit	96 Test	38220090	24,500.00
CLS1411HU	Human Cubilin(CUBN)ELISA Kit	96 Test	38220090	24,500.00
CLS1412HU	Human lymphocyte function associated antigen 2,LFA-2 ELISA Kit	96 Test	38220090	24,500.00
CLS1413HU	Human Protein Kinase C alpha(PKC-alpha)ELISA Kit	96 Test	38220090	24,500.00
CLS1414HU	Human Interleukin 6 receptor,IL6R ELISA Kit	96 Test	38220090	24,500.00
CLS1415HU	Human Alpha Klotho(alpha Klotho)ELISA Kit	96 Test	38220090	24,500.00
CLS1416HU	Human apoptosis signal regulating kinase 1,ASK-1 ELISA Kit	96 Test	38220090	24,500.00
CLS1417HU	Human carbohydrate-deficient transferrin,CDT ELISA Kit	96 Test	38220090	24,500.00
CLS1418HU	Human soluble transferrin receptor,sTfR ELISA Kit	96 Test	38220090	24,500.00
CLS1419HU	Human Myosin Binding Protein C,Cardiac(MYBPC3)ELISA Kit	96 Test	38220090	24,500.00
CLS1420HU	Human Complement Fragment 4d(C4d)ELISA Kit	96 Test	38220090	24,500.00
CLS1421HU	Human High sensitive Interleukin 1alpha(HS IL-1alpha)ELISA Kit	96 Test	38220090	24,500.00

Cat.No.	Product Description	Pack Size	HSN	Unit Price
CLS1422HU	Human High sensitive Interleukin 2(HS IL-2)ELISA Kit	96 Test	38220090	24,500.00
CLS1423HU	Human High sensitive Interleukin 4(HS IL-4)ELISA Kit	96 Test	38220090	24,500.00
CLS1424HU	Human High sensitive Inerleukin 6(HS IL-6)ELISA Kit	96 Test	38220090	24,500.00
CLS1425HU	Human C-Myc Binding Protein (MYCBP)ELISA Kit	96 Test	38220090	24,500.00
CLS1426HU	Human High sensitive hepcidin 25(HS HEPC-25)ELISA Kit	96 Test	38220090	24,500.00
CLS1427HU	Human myogenin,MYOG ELISA Kit	96 Test	38220090	24,500.00
CLS1428HU	Human Protease,Serine 1(PRSS1)ELISA Kit	96 Test	38220090	24,500.00
CLS1429HU	Human gamma Macroglobulin(gamma-MG)ELISA Kit	96 Test	38220090	24,500.00
CLS1430HU	Human Transforming Growth Factor Beta Receptor II (TGFbR2)ELISA Kit	96 Test	38220090	24,500.00
CLS1431HU	Human Placental Thrombin Inhibitor(PTI)ELISA Kit	96 Test	38220090	24,500.00
CLS1432HU	Human Prostaglandin D2,PGD2 Elisa kit	96 Test	38220090	24,500.00
CLS1433HU	Human N-terminal Pro atrial natriuretic peptide(NT-ProANP)ELISA Kit	96 Test	38220090	24,500.00
CLS1434HU	Human Apolipoprotein B1(APOB1)ELISA Kit	96 Test	38220090	24,500.00
CLS1435HU	Human Soluble Cluster of differentiation 200(sCD200)ELISA Kit	96 Test	38220090	24,500.00
CLS1436HU	Human Omentin-1(Omentin-1)ELISA Kit	96 Test	38220090	24,500.00
CLS1437HU	Human Prostaglandin A1(PGA1)ELISA Kit	96 Test	38220090	24,500.00
CLS1438HU	Human Lctin like oxLDL Receptor 1(LOX-1)ELISA Kit	96 Test	38220090	24,500.00
CLS1439HU	Human Rho-associated protein Kinase 1(ROCK1)ELISA Kit	96 Test	38220090	24,500.00
CLS1440HU	Human Nectin-4(Nectin-4)ELISA Kit	96 Test	38220090	24,500.00
CLS1441HU	Human Receptor Activator Of Nuclear Factor Kappa B(RANK)ELISA Kit	96 Test	38220090	24,500.00
CLS1442HU	Human Glucagon-like peptide 1 receptor (GLP1R) ELISA Kit	96 Test	38220090	24,500.00
CLS1443HU	Human cathepsin S,cath-S ELISA Kit	96 Test	38220090	24,500.00
CLS1444HU	Human Cystatin C,Cys-C ELISA Kit	96 Test	38220090	24,500.00
CLS1445HU	Human luteotropic hormone(PRL/LTH)ELISA Kit	96 Test	38220090	24,500.00
CLS1446HU	Human ovarian cancer marker-CA125(CA125)ELISA Kit	96 Test	38220090	24,500.00
CLS1447HU	Human Arginine Glutamic Acid dipeptide Repeats Protein(RERE)ELISA Kit	96 Test	38220090	24,500.00
CLS1448HU	Human Interleukin 1 Receptor like Protein 1(IL1RL1)ELISA Kit	96 Test	38220090	24,500.00
CLS1449HU	Human interleukin-1 receptor antagonist(IL-1RA)ELISA Kit	96 Test	38220090	24,500.00
CLS1450HU	Human Meprin A subunit alpha(MEP1A)ELISA Kit	96 Test	38220090	24,500.00
CLS1451HU	Human Filamin-C(FLNC)ELISA Kit	96 Test	38220090	24,500.00
CLS1452HU	Human Lymphocyte Cytosolic Protein 1(LCP1)ELISA Kit	96 Test	38220090	24,500.00
CLS1453HU	Human Sterile alpha and TIR motif-containing protein 1(Sarm1)ELISA Kit	96 Test	38220090	24,500.00
CLS1454HU	Human Factor VII (Factor 7) ELISA KIT	96 Test	38220090	24,500.00
CLS1455HU	Human Fructosamine,FTA ELISA kit	96 Test	38220090	24,500.00
CLS1456HU	Human Macrophage stimulating 1(MST-1)ELISA Kit	96 Test	38220090	24,500.00
CLS1457HU	Human Stromelysin-2,ST2 ELISA Kit	96 Test	38220090	24,500.00
CLS1458HU	Human 17beta-estradiol(E2)ELISA Kit	96 Test	38220090	24,500.00
CLS1459HU	Human 2-Methoxyestradiol(2-MeOE2)ELISA Kit	96 Test	38220090	24,500.00
CLS1460HU	Human Nuclear matrix protein 22,NMP-22 ELISA Kit	96 Test	38220090	24,500.00
CLS1461HU	Human Free Prostate Specific Antigen,fPSA ELISA Kit	96 Test	38220090	24,500.00
CLS1462HU	Human Aminopeptidase N(ANPEP)ELISA Kit	96 Test	38220090	24,500.00
CLS1463HU	Human Melanocortine Receptor-1(MCR1)ELISA Kit	96 Test	38220090	24,500.00
CLS1464HU	Human D2-Hydroxyglutarate Dehydrogenase (D2HGDH)ELISA Kit	96 Test	38220090	24,500.00
CLS1465HU	Human alphall-spectrin breakdown products SBDP120(SDBP120)ELISA Kit	96 Test	38220090	24,500.00
CLS1466HU	Human Glycocalicin(GC)ELISA Kit	96 Test	38220090	24,500.00
CLS1467HU	Human Phosphatidylinositol-glycan biosynthesis class F protein(PIGF)ELISA Kit	96 Test	38220090	24,500.00

Cat.No.	Product Description	Pack Size	HSN	Unit Price
CLS1468HU	Human Cytidine Deaminase(CDA)ELISA Kit	96 Test	38220090	24,500.00
CLS1469HU	Human Hypoxantin(Hypoxantin)ELISA Kit	96 Test	38220090	24,500.00
CLS1470HU	Human 3-Hydroxy-3-methylglutaryl CoA Reductase(HMGCR)ELISA Kit	96 Test	38220090	24,500.00
CLS1471HU	Human Alpha II spectrin breakdown product(SBDP150)ELISA Kit	96 Test	38220090	24,500.00
CLS1472HU	Human Fructose-1,6-bisphosphate aldolase,FDA ELISA Kit	96 Test	38220090	24,500.00
CLS1473HU	Human Serotransferrin(TF)ELISA Kit	96 Test	38220090	24,500.00
CLS1474HU	Human Hemoglobin subunit beta(HBB) ELISA Kit	96 Test	38220090	24,500.00
CLS1475HU	Human Glutathione S-transferase omega-1(GSTO1)ELISA Kit	96 Test	38220090	24,500.00
CLS1476HU	Human Calreticulin(CRT)ELISA Kit	96 Test	38220090	24,500.00
CLS1477HU	Human Alpha II spectrin breakdown products SBDP120(SBDP120)ELISA Kit	96 Test	38220090	24,500.00
CLS1478HU	Human Alpha II spectrin breakdown products SBDP145(SBDP145)ELISA Kit	96 Test	38220090	24,500.00
CLS1479HU	Human Dopamin transporter(DAT)ELISA Kit	96 Test	38220090	24,500.00
CLS1480HU	Human Serotonin Transporter(SERT)ELISA Kit	96 Test	38220090	24,500.00
CLS1481HU	Human Melanophilin(MLPH)ELISA Kit	96 Test	38220090	24,500.00
CLS1482HU	Human type I procollagen,PC I ELISA Kit	96 Test	38220090	24,500.00
CLS1483HU	Human Magnesium transporter NIPA1(NIPA1)ELISA Kit	96 Test	38220090	24,500.00
CLS1484HU	Human Glyoxylate reductase,hydroxypyruvate reductase(GRHPR)ELISA Kit	96 Test	38220090	24,500.00
CLS1485HU	Human Interferon Kappa(IFNk)ELISA Kit	96 Test	38220090	24,500.00
CLS1486HU	Human des-gamma-carboxy-prothrombin(DCP)ELISA Kit	96 Test	38220090	24,500.00
CLS1487HU	Human Acid Phosphatase 5, TartRate Resistant(ACP5)ELISA Kit	96 Test	38220090	24,500.00
CLS1488HU	Human Muscarinic receptor1(CHRM1)ELISA Kit	96 Test	38220090	24,500.00
CLS1489HU	Human advanced glycation end products,AGEs ELISA Kit	96 Test	38220090	24,500.00
CLS1490HU	Human Islet amyloid polypeptide,IAPP ELISA Kit	96 Test	38220090	24,500.00
CLS1491HU	Human Amylin(Amylin)ELISA Kit	96 Test	38220090	24,500.00
CLS1492HU	Human Pentosidine(Pentosidine)ELISA Kit	96 Test	38220090	24,500.00
CLS1493HU	Human Insulin,INS ELISA Kit	96 Test	38220090	24,500.00
CLS1494HU	Human Neonatal Thyroxine,NN-T4 ELISA Kit	96 Test	38220090	24,500.00
CLS1495HU	Human Glucose dependent insulin releasing polypeptide,GIP ELISA Kit	96 Test	38220090	24,500.00
CLS1496HU	Human beta,beta-carotene 9',10'-oxygenase,BCO2 ELISA Kit	96 Test	38220090	24,500.00
CLS1497HU	Human Tri-iodothyronine,T3 ELISA Kit	96 Test	38220090	24,500.00
CLS1498HU	Human thyroxine,T4 ELISA Kit	96 Test	38220090	24,500.00
CLS1499HU	human soluble receptor for advanced glycation end products,sRAGE ELISA Kit	96 Test	38220090	24,500.00
CLS1500HU	Human Receptor for advanced glycation end products, RAGE/AGER ELISA Kit	96 Test	38220090	24,500.00
CLS1501HU	Human Pancreatic Polypeptide,PP ELISA Kit	96 Test	38220090	24,500.00
CLS1502HU	Human insulin autoantibodies,IAA ELISA Kit	96 Test	38220090	24,500.00
CLS1503HU	Human Interleukin 29,IL-29 ELISA Kit	96 Test	38220090	24,500.00
CLS1504HU	Human Testosterone,T ELISA Kit	96 Test	38220090	24,500.00
CLS1505HU	Human Interleukin 33,IL-33 ELISA Kit	96 Test	38220090	24,500.00
CLS1506HU	Human fibroblast growth factor 2,FGF2 ELISA Kit	96 Test	38220090	24,500.00
CLS1507HU	Human Interleukin 21,IL-21 ELISA Kit	96 Test	38220090	24,500.00
CLS1508HU	Human C-C motif chemokine 24 (CCL24)ELISA Kit	96 Test	38220090	24,500.00
CLS1509HU	Human fibroblast growth factor-23,FGF-23 ELISA Kit	96 Test	38220090	24,500.00
CLS1510HU	Human transforming growth factors beta2,TGF-beta2 ELISA Kit	96 Test	38220090	24,500.00
CLS1511HU	Human Perforin/Pore-forming protein,PF/PFP ELISA Kit	96 Test	38220090	24,500.00
CLS1512HU	Human Platelet-Derived Growth Factor-BB,PDGF-BB ELISA kit	96 Test	38220090	24,500.00

Cat.No.	Product Description	Pack Size	HSN	Unit Price
CLS1513HU	Human Interferon-alpha,IFN-alpha ELISA Kit	96 Test	38220090	24,500.00
CLS1514HU	Human Tumor necrosis factor-beta,TNF-beta ELISA KIT	96 Test	38220090	24,500.00
CLS1515HU	Human regulated on activation in normal T-cell expressed and secreted,RANTES ELISA kit	96 Test	38220090	24,500.00
CLS1516HU	Human Macrophage Inflammatory Protein-3beta,MIP-3beta ELISA kit	96 Test	38220090	24,500.00
CLS1517HU	Human Interleukin 9,IL-9 ELISA KIT	96 Test	38220090	24,500.00
CLS1518HU	Human Interleukin 5,IL-5 ELISA KIT	96 Test	38220090	24,500.00
CLS1519HU	Human Interleukin 4,IL-4 ELISA Kit	96 Test	38220090	24,500.00
CLS1520HU	Human Interleukin 3,IL-3 ELISA KIT	96 Test	38220090	24,500.00
CLS1521HU	Human Interleukin 15,IL-15 ELISA KIT	96 Test	38220090	24,500.00
CLS1522HU	Human Interleukin 12,IL-12/P70 ELISA Kit	96 Test	38220090	24,500.00
CLS1523HU	Human Interleukin 12,IL-12/P40 ELISA Kit	96 Test	38220090	24,500.00
CLS1524HU	Human Interleukin 11,IL-11 ELISA KIT	96 Test	38220090	24,500.00
CLS1525HU	Human Interferon-gamma ,IFN-gamma ELISA Kit	96 Test	38220090	24,500.00
CLS1526HU	Human hepatocyte growth factor,HGF ELISA kit	96 Test	38220090	24,500.00
CLS1527HU	Human Eotaxin 1(CCL11) ELISA Kit	96 Test	38220090	24,500.00
CLS1528HU	Human basic fibroblast growth factor 4,bFGF-4 ELISA Kit	96 Test	38220090	24,500.00
CLS1529HU	Human Activin A,ACV-A ELISA Kit	96 Test	38220090	24,500.00
CLS1530HU	Human secondary lymphoid-tissue chemokine,SLC ELISA Ki	96 Test	38220090	24,500.00
CLS1531HU	Human CXC-chemokine receptor 1,CXCR1 ELISA Kit	96 Test	38220090	24,500.00
CLS1532HU	Human glial cell line-derived neurotrophic factor,GDNF ELISA KIT	96 Test	38220090	24,500.00
CLS1533HU	Human Podoplanin (PDPN)ELISA kit	96 Test	38220090	24,500.00
CLS1534HU	Human monocyte chemotactic protein 3,MCP-3 ELISA kit	96 Test	38220090	24,500.00
CLS1535HU	Human Epithelial neutrophil activating peptide 78,ENA-78 ELISA Kit	96 Test	38220090	24,500.00
CLS1536HU	Human transforming growth factor-alpha,TGF-alpha ELISA Kit	96 Test	38220090	24,500.00
CLS1537HU	Human Macrophage Inflammatory Protein-1alpha,MIP-1alpha ELISA kit	96 Test	38220090	24,500.00
CLS1538HU	Human Interleukin 17,IL-17 ELISA Kit	96 Test	38220090	24,500.00
CLS1539HU	Human Interleukin 1beta,IL-1beta ELISA Kit	96 Test	38220090	24,500.00
CLS1540HU	Human Epidermal growth factor,EGF ELISA Kit	96 Test	38220090	24,500.00
CLS1541HU	Human basic fibroblast growth factor,bFGF ELISA Kit	96 Test	38220090	24,500.00
CLS1542HU	Human Mucosae associated epithelia chemokine,MEC/CCL28 ELISA Kit	96 Test	38220090	24,500.00
CLS1543HU	Human Interferon inducible T-cell Chemoattractant,I-TAC ELISA Kit	96 Test	38220090	24,500.00
CLS1544HU	Human Interferon-beta,IFN-beta/IFNB ELISA Kit	96 Test	38220090	24,500.00
CLS1545HU	Human heparin-binding epidermal growth factor-like growth factor,HB-EGF ELISA Kit	96 Test	38220090	24,500.00
CLS1546HU	Human growth-regulated oncogene-alpha/melanoma growth stimulating activity,GRO-alpha/MGSA ELISA Kit	96 Test	38220090	24,500.00
CLS1547HU	Human underglycosylated(IgA1)ELISA Kit	96 Test	38220090	24,500.00
CLS1548HU	Human Immunoglobulin M,IgM ELISA Kit	96 Test	38220090	24,500.00
CLS1549HU	human Immunoglobulin E,IgE ELISA Kit	96 Test	38220090	24,500.00
CLS1550HU	Human Immunoglobulin A,IgA ELISA Kit	96 Test	38220090	24,500.00
CLS1551HU	Human Vascular cell adhesion molecule 1,VCAM-1 ELISA kit	96 Test	38220090	24,500.00
CLS1552HU	Human soluble interleukin-2 receptor,IL-2sRalpha ELISA kit	96 Test	38220090	24,500.00
CLS1553HU	Human E-Cadherin,E-Cad ELISA Kit	96 Test	38220090	24,500.00
CLS1554HU	Human intercellular adhesion molecule 1,ICAM-1 ELISA Kit	96 Test	38220090	24,500.00
CLS1555HU	Human soluble Tumor Necrosis Factor alpha receptor,sTNFalphaR ELISA Kit	96 Test	38220090	24,500.00

Cat.No.	Product Description	Pack Size	HSN	Unit Price
CLS1556HU	Human platelet membrane glycoprotein I bIXalpha,GP-I bIXalpha ELISA Kit	96 Test	38220090	24,500.00
CLS1557HU	Human cluster Of differentiation,CD34 ELISA Kit	96 Test	38220090	24,500.00
CLS1558HU	Human Cluster of differentiation 98,CD98 ELISA Kit	96 Test	38220090	24,500.00
CLS1559HU	Human Epidermal growth factor receptor 2,HER2 ELISA Kit	96 Test	38220090	24,500.00
CLS1560HU	Human CC Chemokine receptor 4,CCR-4 ELISA Kit	96 Test	38220090	24,500.00
CLS1561HU	human myeloid cell nuclear differentiation antigen,MNDA ELISA Kit	96 Test	38220090	24,500.00
CLS1562HU	Human C-type lectin domain family 4 member e,CLEC4E ELISA Kit	96 Test	38220090	24,500.00
CLS1563HU	Human protocadherin 1,PCDH1 ELISA Kit	96 Test	38220090	24,500.00
CLS1564HU	Human Orexin receptor,OXR ELISA Kit	96 Test	38220090	24,500.00
CLS1565HU	Human integrin β 2,ITG β 2/CD11+CD18 ELISA Kit	96 Test	38220090	24,500.00
CLS1566HU	human oncostatin M receptor,OSMR ELISA Kit	96 Test	38220090	24,500.00
CLS1567HU	Human Vasculoar endothelial cell growth factor receptor 1,VEGFR-1/Flt1 ELISA kit	96 Test	38220090	24,500.00
CLS1568HU	Human endothelium Selectin,E-Selectin ELISA kit	96 Test	38220090	24,500.00
CLS1569HU	Human soluble endothelium-selectin,sE-selectin ELISA Kit	96 Test	38220090	24,500.00
CLS1570HU	Human soluble Vascular cell adhesion molecule 1,sVCAM-1 ELISA Kit	96 Test	38220090	24,500.00
CLS1571HU	Human Triggering Receptor Expresses on Myeloid Cells-1,TREM-1 ELISA Kit	96 Test	38220090	24,500.00
CLS1572HU	Human membrane cofactor protein,MCP ELISA Kit	96 Test	38220090	24,500.00
CLS1573HU	Human vitronectin,VNR ELISA Kit	96 Test	38220090	24,500.00
CLS1574HU	Human Receptor II for the Fc region of immunoglobulin G,Fc γ R II ELISA Kit	96 Test	38220090	24,500.00
CLS1575HU	Human Receptor I for the Fc region of immunoglobulin G,Fc γ R I /CD64 ELISA Kit	96 Test	38220090	24,500.00
CLS1576HU	Human Leptin Soluble Receptor,sLR ELISA Kit	96 Test	38220090	24,500.00
CLS1577HU	Human Integrin α V β 3,ITG α V β 3 ELISA Kit	96 Test	38220090	24,500.00
CLS1578HU	Human epidermal growth factor receptor,EGFR ELISA Kit	96 Test	38220090	24,500.00
CLS1579HU	Human Interleukin-2 receptor,IL-2R/CD122 ELISA kit	96 Test	38220090	24,500.00
CLS1580HU	Human Soluble Endoglin,ENG/sCD105 ELISA Kit	96 Test	38220090	24,500.00
CLS1581HU	Human soluble cluster of differentiation 14,sCD14 ELISA Kit	96 Test	38220090	24,500.00
CLS1582HU	Human terminal complement complex C5b-9,TCC C5b-9 ELISA Kit	96 Test	38220090	24,500.00
CLS1583HU	Human Lysozyme,LZM/LSZ ELISA Kit	96 Test	38220090	24,500.00
CLS1584HU	Human ficolin 3,FCN3 ELISA Kit	96 Test	38220090	24,500.00
CLS1585HU	Human Toll-like receptor 7,TLR7 ELISA Kit	96 Test	38220090	24,500.00
CLS1586HU	Human myeloid differentiation factor 88, MyD88 ELISA Kit	96 Test	38220090	24,500.00
CLS1587HU	Human Toll-like receptor 4,TLR4 ELISA Kit	96 Test	38220090	24,500.00
CLS1588HU	Human Toll-like receptor 2,TLR2 ELISA Kit	96 Test	38220090	24,500.00
CLS1589HU	Human membrane attack complex,MAC ELISA Kit	96 Test	38220090	24,500.00
CLS1590HU	Human Toll-like receptor 5,TLR5 ELISA Kit	96 Test	38220090	24,500.00
CLS1591HU	Human Toll-like receptor 8,TLR8 ELISA Kit	96 Test	38220090	24,500.00
CLS1592HU	Human Linker for activation of T cell,LAT ELISA Kit	96 Test	38220090	24,500.00
CLS1593HU	Human insulin-like growth factors binding protein 3,IGFBP-3 ELISA Kit	96 Test	38220090	24,500.00
CLS1594HU	Human latent transforming growth factor beta binding protein 2,LTBP2 ELISA Kit	96 Test	38220090	24,500.00
CLS1595HU	Human Myostatin,MSTN ELISA Kit	96 Test	38220090	24,500.00
CLS1596HU	Human insulin-like growth factors binding protein 1,IGFBP-1 ELISA Kit	96 Test	38220090	24,500.00
CLS1597HU	Human interferon-inducible protein 10,IP-10 ELISA Kit	96 Test	38220090	24,500.00
CLS1598HU	Human Agrin(AGRN)ELISA Kit	96 Test	38220090	24,500.00
CLS1599HU	Human hypoxia-inducible factor 1 α ,HIF-1 α ELISA Kit	96 Test	38220090	24,500.00

Cat.No.	Product Description	Pack Size	HSN	Unit Price
CLS1600HU	Human leukocyte antigen C,HLA-C ELISA Kit	96 Test	38220090	24,500.00
CLS1601HU	Human leucocyte antigen B27,HLA-B27 ELISA Kit	96 Test	38220090	24,500.00
CLS1602HU	Human soluble human leucocyte antigen G1,sHLA-G ELISA Kit	96 Test	38220090	24,500.00
CLS1603HU	Human leukocyte antigen G,HLA-G ELISA Kit	96 Test	38220090	24,500.00
CLS1604HU	Human leukocyte antigen A,HLA-A ELISA Kit	96 Test	38220090	24,500.00
CLS1605HU	Human anti-ganglioside antibody,GM1 ELISA Kit	96 Test	38220090	24,500.00
CLS1606HU	Human anti-mutated citrullinated vimentin antibody,MCV ELISA Kit	96 Test	38220090	24,500.00
CLS1607HU	Human myelin basic protein autoantibody,MBP ELISA Kit	96 Test	38220090	24,500.00
CLS1608HU	human anti-nucleosome antibody IgG,AnuA-IgG ELISA Kit	96 Test	38220090	24,500.00
CLS1609HU	human glutamic acid decarboxylase autoantibody,GAD-Ab ELISA Kit	96 Test	38220090	24,500.00
CLS1610HU	Human Anti-mitochondria autoantibodies,AMA ELISA Kit	96 Test	38220090	24,500.00
CLS1611HU	Human adrenal cortex antibody,ACA ELISA Kit	96 Test	38220090	24,500.00
CLS1612HU	Human Thyroid Antibody,TAbs ELISA Kit	96 Test	38220090	24,500.00
CLS1613HU	Human islet cell antibody,ICAb ELISA Kit	96 Test	38220090	24,500.00
CLS1614HU	Human natural deoxyribonucleic acid antibody,n-DNA-Ab ELISA Kit	96 Test	38220090	24,500.00
CLS1615HU	Human anti-Actin antibody,AAA ELISA Kit	96 Test	38220090	24,500.00
CLS1616HU	Human heparin associated antibody,HIT ELISA Kit	96 Test	38220090	24,500.00
CLS1617HU	Human beta2 glycoprotein, β 2-GP ELISA Kit	96 Test	38220090	24,500.00
CLS1618HU	Human acetylcholine receptor antibody,AChRab ELISA Kit	96 Test	38220090	24,500.00
CLS1619HU	Human lupus anticoagulant,LAC/LA ELISA Kit	96 Test	38220090	24,500.00
CLS1620HU	Human anti-perinuclear factor,APF ELISA Kit	96 Test	38220090	24,500.00
CLS1621HU	Human Anti-smooth muscle antibody,ASMA ELISA Kit	96 Test	38220090	24,500.00
CLS1622HU	Human anti-gastric parietal cell antibody,AGPA/PCA ELISA Kit	96 Test	38220090	24,500.00
CLS1623HU	Human Aquaporin 4,AQP-4 ELISA Kit	96 Test	38220090	24,500.00
CLS1624HU	Human soluble receptor activator of nuclear factor-kB ligand,sRANKL ELISA Kit	96 Test	38220090	24,500.00
CLS1625HU	human signal transducer and activator of transcription 3,STAT3 ELISA Kit	96 Test	38220090	24,500.00
CLS1626HU	human signal transducer and activator of transcription 5,STAT5 ELISA Kit	96 Test	38220090	24,500.00
CLS1627HU	Human suppressors of cytokine signaling 3,SOCS-3 ELISA Kit	96 Test	38220090	24,500.00
CLS1628HU	Human cyclophilin B,CyPB ELISA Kit	96 Test	38220090	24,500.00
CLS1629HU	Human paxillin,Pax ELISA Kit	96 Test	38220090	24,500.00
CLS1630HU	Human Mothers against decapentaplegic homolog 4,Smad4 ELISA Kit	96 Test	38220090	24,500.00
CLS1631HU	Human inositol 1,4,5,-trisphosphate,IP3 ELISA kit	96 Test	38220090	24,500.00
CLS1632HU	Human Citrate synthase,CS ELISA Kit	96 Test	38220090	24,500.00
CLS1633HU	Human matrix metalloproteinase 14,MMP-14 ELISA Kit	96 Test	38220090	24,500.00
CLS1634HU	Human tyrosine hydroxylase,TH ELISA Kit	96 Test	38220090	24,500.00
CLS1635HU	Human lipid peroxide,LPO ELISA Kit	96 Test	38220090	24,500.00
CLS1636HU	Human iduronate sulfatase,IDS ELISA Kit	96 Test	38220090	24,500.00
CLS1637HU	Human Lactate Dehydrogenase,LDH ELISA Kit	96 Test	38220090	24,500.00
CLS1638HU	Human matrix metalloproteinase 28,MMP-28 ELISA Kit	96 Test	38220090	24,500.00
CLS1639HU	Human Prostaglandin D synthase,PTGDS ELISA Kit	96 Test	38220090	24,500.00
CLS1640HU	Human cysteinyl aspartate specific proteinases 12,Caspase-12 ELISA Kit	96 Test	38220090	24,500.00
CLS1641HU	Human cytosolic phospholipase A2,cPLA2 ELISA Kit	96 Test	38220090	24,500.00
CLS1642HU	Human Streptokinase,SK ELISA Kit	96 Test	38220090	24,500.00
CLS1643HU	Human Cytochrome P450c21/21-hydroxylase,CYP21B ELISA Kit	96 Test	38220090	24,500.00
CLS1644HU	Human indoleamine 2,3-dioxygenase,IDO ELISA Kit	96 Test	38220090	24,500.00

Cat.No.	Product Description	Pack Size	HSN	Unit Price
CLS1645HU	Human β -site APP-Cleaving Enzyme 1,BACE1 ELISA kit	96 Test	38220090	24,500.00
CLS1646HU	Human phosphoenolpyruvate carboxykinase,PCK ELISA Kit	96 Test	38220090	24,500.00
CLS1647HU	Human trypsin(Trypsin)ELISA Kit	96 Test	38220090	24,500.00
CLS1648HU	Human sorbitol dehydrogenase,SDH ELISA Kit	96 Test	38220090	24,500.00
CLS1649HU	Human ornithine carbamoyl transferase,OCT ELISA Kit	96 Test	38220090	24,500.00
CLS1650HU	Human Elastase(Elastase)ELISA Kit	96 Test	38220090	24,500.00
CLS1651HU	Human alkaline phosphatase,ALP ELISA Kit	96 Test	38220090	24,500.00
CLS1652HU	Human Pancreatic Amylase,PAMY ELISA Kit	96 Test	38220090	24,500.00
CLS1653HU	Human α -galactosidase, α GAL ELISA Kit	96 Test	38220090	24,500.00
CLS1654HU	Human α N-acetylglucosaminidase, α NAG ELISA Kit	96 Test	38220090	24,500.00
CLS1655HU	Human Cathepsin K,cath-K ELISA Kit	96 Test	38220090	24,500.00
CLS1656HU	Human acid sphingomyelinase, ASM ELISA Kit	96 Test	38220090	24,500.00
CLS1657HU	Human extracellular signal-regulated kinase,ERK ELISA Kit	96 Test	38220090	24,500.00
CLS1658HU	Human arachidonate 5-lipoxygenase,ALOX-5 ELISA Kit	96 Test	38220090	24,500.00
CLS1659HU	Human 5-lipoxygenase,5-LO/LOX ELISA Kit	96 Test	38220090	24,500.00
CLS1660HU	Human Polymorphonuclear Elastase,PMN Elastase ELISA Kit	96 Test	38220090	24,500.00
CLS1661HU	Human Kallikrein 6,KLK6 ELISA Kit	96 Test	38220090	24,500.00
CLS1662HU	Human glutamic acid decarboxylase,GAD ELISA Kit	96 Test	38220090	24,500.00
CLS1663HU	Human focal adhesion kinase,FAK ELISA Kit	96 Test	38220090	24,500.00
CLS1664HU	Human Deoxyribonuclease 1,DNase-1 ELISA Kit	96 Test	38220090	24,500.00
CLS1665HU	Human Calf intestinal alkaline phosphatase,CIAP ELISA Kit	96 Test	38220090	24,500.00
CLS1666HU	Human dopachrome tautomerase,DT ELISA Kit	96 Test	38220090	24,500.00
CLS1667HU	Human Phosphotylinosital 3 kinase,PI3K ELISA Kit	96 Test	38220090	24,500.00
CLS1668HU	Human carbonic anhydrase 2,CA-2 ELISA Kit	96 Test	38220090	24,500.00
CLS1669HU	Human matrix metalloproteinase 4,MMP-4 ELISA Kit	96 Test	38220090	24,500.00
CLS1670HU	Human Matrix metalloproteinase 2/Gelatinase A,MMP-2 ELISA kit	96 Test	38220090	24,500.00
CLS1671HU	Human Matrix metalloproteinase 10,MMP-10 ELISA kit	96 Test	38220090	24,500.00
CLS1672HU	Human Matrix metalloproteinase 7,MMP-7 ELISA kit	96 Test	38220090	24,500.00
CLS1673HU	Human urokinase plasminogen activator,uPA ELISA kit	96 Test	38220090	24,500.00
CLS1674HU	Human Pepsin,PP ELISA Kit	96 Test	38220090	24,500.00
CLS1675HU	Human thioredoxin reductase,TrxR ELISA Kit	96 Test	38220090	24,500.00
CLS1676HU	Human Endothelial lipase,EL ELISA Kit	96 Test	38220090	24,500.00
CLS1677HU	Human matrix metalloproteinase 5,MMP-5 ELISA Kit	96 Test	38220090	24,500.00
CLS1678HU	Human matrix metalloproteinase 9/Gelatinase B,MMP-9 ELISA Kit	96 Test	38220090	24,500.00
CLS1679HU	Human secreted phospholipase A2,sPLA2 ELISA Kit	96 Test	38220090	24,500.00
CLS1680HU	Human glutathione S-transferases,GSTs ELISA Kit	96 Test	38220090	24,500.00
CLS1681HU	Human glutathione S-transferases,GSTpi ELISA Kit	96 Test	38220090	24,500.00
CLS1682HU	Human tryptase,TPS ELISA Kit	96 Test	38220090	24,500.00
CLS1683HU	Human cysteinyl aspartate specific proteinases-9,Caspase-9 ELISA Kit	96 Test	38220090	24,500.00
CLS1684HU	Human cysteinyl aspartate specific proteinases-3,Caspase-3 ELISA Kit	96 Test	38220090	24,500.00
CLS1685HU	Human Obestatin,OB ELISA kit	96 Test	38220090	24,500.00
CLS1686HU	Human inhibin beta-B,Inhbb ELISA Kit	96 Test	38220090	24,500.00
CLS1687HU	Human Presenilin 2,PS-2 ELISA Kit	96 Test	38220090	24,500.00
CLS1688HU	Human inhibin B,INH-B ELISA Kit	96 Test	38220090	24,500.00
CLS1689HU	Human norepinephrine,NE ELISA Kit	96 Test	38220090	24,500.00
CLS1690HU	Human Growth Hormone Binding Protein,GHBP ELISA Kit	96 Test	38220090	24,500.00
CLS1691HU	human ultrasensitive thyroid-stimulating hormone,U-TSH ELISA Kit	96 Test	38220090	24,500.00
CLS1692HU	human prolactin,PRL ELISA Kit	96 Test	38220090	24,500.00
CLS1693HU	human corticotropin releasing hormone,CRH ELISA Kit	96 Test	38220090	24,500.00

Cat.No.	Product Description	Pack Size	HSN	Unit Price
CLS1694HU	human Prostaglandin D2-methoxime,PGD2-MOX ELISA KIT	96 Test	38220090	24,500.00
CLS1695HU	Human Progesterone,PROG ELISA kit	96 Test	38220090	24,500.00
CLS1696HU	Human estrogen,E ELISA Kit	96 Test	38220090	24,500.00
CLS1697HU	Human Follistatin,FS ELISA Kit	96 Test	38220090	24,500.00
CLS1698HU	Human Renin(Ren)ELISA Kit	96 Test	38220090	24,500.00
CLS1699HU	Human Glucagon,GC ELISA Kit	96 Test	38220090	24,500.00
CLS1700HU	Human adrenomedullin,ADM ELISA Kit	96 Test	38220090	24,500.00
CLS1701HU	Human Luteinizing Hormone-Releasing Hormone,LHRH ELISA Kit	96 Test	38220090	24,500.00
CLS1702HU	Human Dehydroepiandrosterone,DHEA ELISA Kit	96 Test	38220090	24,500.00
CLS1703HU	Human growth hormone,GH ELISA KIT	96 Test	38220090	24,500.00
CLS1704HU	Human Thrombopoietin,TPO ELISA kit	96 Test	38220090	24,500.00
CLS1705HU	Human Estriol,E3 ELISA Kit	96 Test	38220090	24,500.00
CLS1706HU	Human 17-Hydroxyprogesterone,17-OHP ELISA Kit	96 Test	38220090	24,500.00
CLS1707HU	Human Luteinizing Hormone,LH ELISA Kit	96 Test	38220090	24,500.00
CLS1708HU	Human oxytocin,OT ELISA Kit	96 Test	38220090	24,500.00
CLS1709HU	Human anti-diuretic hormone,ADH ELISA Kit	96 Test	38220090	24,500.00
CLS1710HU	human free chorionic gonadotropin,f-βhCG ELISA KIT	96 Test	38220090	24,500.00
CLS1711HU	Human Dehydroepiandrosterone sulfate,DHEA-S ELISA Kit	96 Test	38220090	24,500.00
CLS1712HU	Human Thyroid Stimulating Hormone,TSH ELISA Kit	96 Test	38220090	24,500.00
CLS1713HU	Human intact Parathormone ,i-PTH ELISA Kit	96 Test	38220090	24,500.00
CLS1714HU	Human Somatostatin,SS ELISA Kit	96 Test	38220090	24,500.00
CLS1715HU	Human growth hormone releasing hormone,GHRH ELISA Kit	96 Test	38220090	24,500.00
CLS1716HU	Human Pulmonary surfatcant-associated protein B,SP-B ELISA Kit	96 Test	38220090	24,500.00
CLS1717HU	Human Pulmonary surfatcant-associated protein A,SP-A ELISA Kit	96 Test	38220090	24,500.00
CLS1718HU	Human Pulmonary surfatcant-associated protein C,SP-C ELISA Kit	96 Test	38220090	24,500.00
CLS1719HU	Human Pulmonary surfatcant-associated protein D,SP-D ELISA Kit	96 Test	38220090	24,500.00
CLS1720HU	Human Glomerular tissue extract-advanced glycosylation end products,GTE-AGE ELISA Kit	96 Test	38220090	24,500.00
CLS1721HU	Human Creatinine,Cr ELISA Kit	96 Test	38220090	24,500.00
CLS1722HU	Human Nephryn(Nephryn)ELISA Kit	96 Test	38220090	24,500.00
CLS1723HU	Human α2 macroglobulin(α2-MG)ELISA Kit	96 Test	38220090	24,500.00
CLS1724HU	Human Kidney injury molecule 1,Kim-1 ELISA Kit	96 Test	38220090	24,500.00
CLS1725HU	Human G protein-activated inward rectifier potassium channel 2,KCNJ6/GIRK2 ELISA Kit	96 Test	38220090	24,500.00
CLS1726HU	human β2-microglobulin,β2-MG ELISA Kit	96 Test	38220090	24,500.00
CLS1727HU	Human thrombospondin 1,TSP-1 ELISA Kit	96 Test	38220090	24,500.00
CLS1728HU	Human platelet-derived growth factor,PDGF ELISA Kit	96 Test	38220090	24,500.00
CLS1729HU	Human D-Dimer,D2D ELISA Kit	96 Test	38220090	24,500.00
CLS1730HU	Human thrombin-antithrombin complex,TAT ELISA Kit	96 Test	38220090	24,500.00
CLS1731HU	Human activated coagulation factor XII,FXIIa ELISA Kit	96 Test	38220090	24,500.00
CLS1732HU	Human Abnormal prothrombin,APT ELISA Kit	96 Test	38220090	24,500.00
CLS1733HU	Human Plasminogen,Plg ELISA Kit	96 Test	38220090	24,500.00
CLS1734HU	Human Tissue factor pathway inhibitor 2,TFPI-2 ELISA Kit	96 Test	38220090	24,500.00
CLS1735HU	Human Prothrombin,PT ELISA Kit	96 Test	38220090	24,500.00
CLS1736HU	Human A disintegrin and metalloproteinase with thrombospondin motifs 1,ADAMTS1 ELISA kit	96 Test	38220090	24,500.00
CLS1737HU	Human platelet activating factor,PAF ELISA Kit	96 Test	38220090	24,500.00
CLS1738HU	Human plasmin-antiplasmin complex,PAP ELISA Kit	96 Test	38220090	24,500.00
CLS1739HU	Human Anti-Thrombin III,AT- III ELISA Kit	96 Test	38220090	24,500.00
CLS1740HU	Human prealbumin,PA ELISA Kit	96 Test	38220090	24,500.00
CLS1741HU	Human von Willebrand Factor,vWF ELISA Kit	96 Test	38220090	24,500.00
CLS1742HU	Human Tissue-type Plasminogen Actilyse,t-PA ELISA Kit	96 Test	38220090	24,500.00

Cat.No.	Product Description	Pack Size	HSN	Unit Price
CLS1743HU	Human thrombus precursor protein,TpP ELISA Kit	96 Test	38220090	24,500.00
CLS1744HU	Human Retinol binding protein,RBP ELISA Kit	96 Test	38220090	24,500.00
CLS1745HU	Human angiotatin,ANG ELISA Kit	96 Test	38220090	24,500.00
CLS1746HU	Human cardiac isoform of Troponin T,cTnT ELISA Kit	96 Test	38220090	24,500.00
CLS1747HU	Human heart fatty acid binding protein,h-FABP ELISA Kit	96 Test	38220090	24,500.00
CLS1748HU	Human tyrosine kinase with immunoglobulin-like and EGF-like domains 2,Tie-2 ELISA Kit	96 Test	38220090	24,500.00
CLS1749HU	Human CXC-chemokine receptor 4,CXCR4 ELISA Kit	96 Test	38220090	24,500.00
CLS1750HU	Human Serum amyloid A,SAA ELISA Kit	96 Test	38220090	24,500.00
CLS1751HU	Human amyloid beta peptide 1-40,Aβ1-40 ELISA Kit	96 Test	38220090	24,500.00
CLS1752HU	Human desmin,Des ELISA Kit	96 Test	38220090	24,500.00
CLS1753HU	Human Thromboxane B2,TX-B2 ELISA Kit	96 Test	38220090	24,500.00
CLS1754HU	Human Myoglobin,MYO ELISA Kit	96 Test	38220090	24,500.00
CLS1755HU	Human soluble endothelial protein C receptor,sEPCR ELISA Kit	96 Test	38220090	24,500.00
CLS1756HU	Human Matrix Gla Protein,MGP ELISA Kit	96 Test	38220090	24,500.00
CLS1757HU	Human anti-Endostatin antibody,ES-Ab ELISA Kit	96 Test	38220090	24,500.00
CLS1758HU	Human Angiotensin II Receptor Type 1(AT ₁ R1)ELISA Kit	96 Test	38220090	24,500.00
CLS1759HU	Human Angiopietin 4,ANG-4 ELISA Kit	96 Test	38220090	24,500.00
CLS1760HU	Human Serum amyloid P,SAP ELISA Kit	96 Test	38220090	24,500.00
CLS1761HU	Human Salusina(Salusina)ELISA Ki	96 Test	38220090	24,500.00
CLS1762HU	Human Troponin I ,Tn- I ELISA Kit	96 Test	38220090	24,500.00
CLS1763HU	Human Salusinβ(Salusinβ)ELISA Kit	96 Test	38220090	24,500.00
CLS1764HU	Human Netrin-1,Ntn1 ELISA Kit	96 Test	38220090	24,500.00
CLS1765HU	Human Orexin B,OX-B ELISA Kit	96 Test	38220090	24,500.00
CLS1766HU	Human Soluble protein-100B,S-100B ELISA Kit	96 Test	38220090	24,500.00
CLS1767HU	Human Neurotrophin 4,NT-4 ELISA KIT	96 Test	38220090	24,500.00
CLS1768HU	Human orphanin FQ/nociceptin,OFQ/N ELISA Kit	96 Test	38220090	24,500.00
CLS1769HU	Human Orexin A(OREXIN A)ELISA Kit	96 Test	38220090	24,500.00
CLS1770HU	Human Neurotrophin-3,NT-3 ELISA KIT	96 Test	38220090	24,500.00
CLS1771HU	Human S100 calcium binding protein P,S100P ELISA kit	96 Test	38220090	24,500.00
CLS1772HU	Human Neurotensin,NT ELISA Kit	96 Test	38220090	24,500.00
CLS1773HU	Human Relaxin,RLN ELISA Kit	96 Test	38220090	24,500.00
CLS1774HU	Human Galanin,GAL ELISA Kit	96 Test	38220090	24,500.00
CLS1775HU	Human total Tau Proteins,tr ELISA kit	96 Test	38220090	24,500.00
CLS1776HU	Human cross-linked C-telopeptides of Type I collagen,C I CP ELISA Kit	96 Test	38220090	24,500.00
CLS1777HU	Human pro-gastrin-releasing peptide, ProGRP ELISA Kit	96 Test	38220090	24,500.00
CLS1778HU	Human Peptide YY(PYY)ELISA Kit	96 Test	38220090	24,500.00
CLS1779HU	Human Hyaluronic acid,HA ELISA Kit	96 Test	38220090	24,500.00
CLS1780HU	Human Total bile acide,TBA ELISA Kit	96 Test	38220090	24,500.00
CLS1781HU	Human C-telopeptide of type II collagen,CTX-II ELISA Kit	96 Test	38220090	24,500.00
CLS1782HU	Human Gastric Mucin,GM ELISA Kit	96 Test	38220090	24,500.00
CLS1783HU	Human Fetuin A,FETU-A ELISA Kit	96 Test	38220090	24,500.00
CLS1784HU	Human rheumatoid factor,RF ELISA Kit	96 Test	38220090	24,500.00
CLS1785HU	Human glycosaminoglycan,GAG ELISA Kit	96 Test	38220090	24,500.00
CLS1786HU	Human Tenascin-C,TN-C ELISA Kit	96 Test	38220090	24,500.00
CLS1787HU	Human Apolipoprotein C2 precursor,Pre-Apo-C2 ELISA kit	96 Test	38220090	24,500.00
CLS1788HU	Human 3-Nitrotyrosine,3-NT ELISA Kit	96 Test	38220090	24,500.00
CLS1789HU	Human Protein Carbonyl,PC ELISA Kit	96 Test	38220090	24,500.00
CLS1790HU	Human lipocalin 2,LCN2 ELISA Kit	96 Test	38220090	24,500.00
CLS1791HU	Human Glucose transporter 3,GLUT3 ELISA Kit	96 Test	38220090	24,500.00
CLS1792HU	Human Mannose,MN ELISA Kit	96 Test	38220090	24,500.00
CLS1793HU	Human histatin 5,HTN5 ELISA Kit	96 Test	38220090	24,500.00
CLS1794HU	Human preptin(preptin)ELISA Kit	96 Test	38220090	24,500.00
CLS1795HU	Human peroxisome proliferators activator receptors alpha,PPAR-α ELISA Kit	96 Test	38220090	24,500.00

Cat.No.	Product Description	Pack Size	HSN	Unit Price
CLS1796HU	Human Thioredoxin,Trx ELISA Kit	96 Test	38220090	24,500.00
CLS1797HU	Human Pyridinoline crosslinks,PYD ELISA Kit	96 Test	38220090	24,500.00
CLS1798HU	Human heparin sulphate protoglycans,HSPG ELISA Kit	96 Test	38220090	24,500.00
CLS1799HU	Human Muscle specific tyrosine kinase, MuSK ELISA kit	96 Test	38220090	24,500.00
CLS1800HU	Human glutathione,GSH ELISA Kit	96 Test	38220090	24,500.00
CLS1801HU	Human L-phenylalanine,LPA ELISA Kit	96 Test	38220090	24,500.00
CLS1802HU	Human 17-Hydroxycorticosteroids,17-OHCS ELISA Kit	96 Test	38220090	24,500.00
CLS1803HU	Human adipose differentiation-related protein,ADRP ELISA Kit	96 Test	38220090	24,500.00
CLS1804HU	Human cartilage oligomeric matrix protein,COMP ELISA Kit	96 Test	38220090	24,500.00
CLS1805HU	Human cartilage oligomeric protein,COMP ELISA Kit	96 Test	38220090	24,500.00
CLS1806HU	Human N-MID Osteocalcin,N-MID-OT ELISA Kit	96 Test	38220090	24,500.00
CLS1807HU	Human N-Acetyl-Ser-Asp-Lys-Pro,AcSDKP ELISA Kit	96 Test	38220090	24,500.00
CLS1808HU	Human Homocysteic acid,Hcy ELISA Kit	96 Test	38220090	24,500.00
CLS1809HU	Human Folic acid,FA ELISA Kit	96 Test	38220090	24,500.00
CLS1810HU	Human Semaphorin 3D (SEMA3D)ELISA Kit	96 Test	38220090	24,500.00
CLS1811HU	Human lipoprotein lipase,LPL ELISA Kit	96 Test	38220090	24,500.00
CLS1812HU	Human deoxypyridinoline,DPD ELISA Kit	96 Test	38220090	24,500.00
CLS1813HU	Human Substance P,SP ELISA Kit	96 Test	38220090	24,500.00
CLS1814HU	Human myelin basic protein,MBP ELISA Kit	96 Test	38220090	24,500.00
CLS1815HU	Human Vitamin C,VC ELISA Kit	96 Test	38220090	24,500.00
CLS1816HU	Human Vitamin B6,VB6 ELISA Kit	96 Test	38220090	24,500.00
CLS1817HU	Human intestinal fatty acid binding protein,iFABP ELISA Kit	96 Test	38220090	24,500.00
CLS1818HU	Human Vitamin D,VD ELISA Kit	96 Test	38220090	24,500.00
CLS1819HU	Human Vitamin D2,VD2 ELISA Kit	96 Test	38220090	24,500.00
CLS1820HU	Human Vitamin D3,VD3 ELISA kit	96 Test	38220090	24,500.00
CLS1821HU	Human Vitamin E,VE ELISA Kit	96 Test	38220090	24,500.00
CLS1822HU	Human Vitamin A,VA ELISA Kit	96 Test	38220090	24,500.00
CLS1823HU	Human adiponectin,ADP ELISA Kit	96 Test	38220090	24,500.00
CLS1824HU	human Histamine,HIS ELISA Kit	96 Test	38220090	24,500.00
CLS1825HU	Human Vitamin D Receptor,VD R ELISA Kit	96 Test	38220090	24,500.00
CLS1826HU	Human Bone-specific Alkphase B,ALP-B ELISA Kit	96 Test	38220090	24,500.00
CLS1827HU	Human Laminin,LN ELISA KIT	96 Test	38220090	24,500.00
CLS1828HU	Human cyclic adenosine monophosphate,cAMP ELISA Kit	96 Test	38220090	24,500.00
CLS1829HU	Human Chlamydia trachomatis,CT ELISA Kit	96 Test	38220090	24,500.00
CLS1830HU	human S100 calcium binding protein A8,S100A8 ELISA Kit	96 Test	38220090	24,500.00
CLS1831HU	human S100 calcium binding protein A9,S100A9 ELISA Kit	96 Test	38220090	24,500.00
CLS1832HU	Human hepatitis B virus X interacting protein,HBXIP ELISA Kit	96 Test	38220090	24,500.00
CLS1833HU	human ubiquitin D,UBD ELISA Kit	96 Test	38220090	24,500.00
CLS1834HU	Human Ubiquitin,Ub ELISA Kit	96 Test	38220090	24,500.00
CLS1835HU	Human cytokeratin fragment antigen 21-1,CYFRA21-1 ELISA Kit	96 Test	38220090	24,500.00
CLS1836HU	Human total prostate s pecific antigen,tPSA ELISA Kit	96 Test	38220090	24,500.00
CLS1837HU	Human pan-cytokeratin,P-CK ELISA Kit	96 Test	38220090	24,500.00
CLS1838HU	Human Midkine,MK ELISA Kit	96 Test	38220090	24,500.00
CLS1839HU	Human breast cancer susceptibility protein 1,BRCA-1 ELISA Kit	96 Test	38220090	24,500.00
CLS1840HU	Human Heat Shock Protein glycoprotein 96,HSP gp96 ELISA Kit	96 Test	38220090	24,500.00
CLS1841HU	Human melanocyte antibody,MC Ab ELISA Kit	96 Test	38220090	24,500.00
CLS1842HU	Human Oncostatin-M,OSM ELISA KIT	96 Test	38220090	24,500.00
CLS1843HU	Human cytokeratin High Molecular Weight,CK-HMW ELISA Kit	96 Test	38220090	24,500.00
CLS1844HU	Human alpha-fetoprotein Lens culinaris agglutiin 3,AFP-L3 ELISA Kit	96 Test	38220090	24,500.00

Cat.No.	Product Description	Pack Size	HSN	Unit Price
CLS1845HU	Human Breast cancer susceptibility protein 2,BRCA-2 ELISA Kit	96 Test	38220090	24,500.00
CLS1846HU	Human Endostatin,ES ELISA Kit	96 Test	38220090	24,500.00
CLS1847HU	Human prostate specific antigen,PSA ELISA Kit	96 Test	38220090	24,500.00
CLS1848HU	Human permeability glycoprotein,P-gp ELISA Kit	96 Test	38220090	24,500.00
CLS1849HU	Human Transfer factor,TF ELISA Kit	96 Test	38220090	24,500.00
CLS1850HU	Human Metallothionein,MT ELISA Kit	96 Test	38220090	24,500.00
CLS1851HU	Human Heat Shock Protein 60,HSP-60 ELISA Kit	96 Test	38220090	24,500.00
CLS1852HU	Human Potassium channel subfamily K member 15,KCNK15 ELISA Kit	96 Test	38220090	24,500.00
CLS1853HU	Human heat shock protein 27,HSP-27 ELISA Kit	96 Test	38220090	24,500.00
CLS1854HU	Human Lipopolysaccharides,LPS ELISA Kit	96 Test	38220090	24,500.00
CLS1855HU	Human Heat Shock Protein 90,HSP-90 ELISA Kit	96 Test	38220090	24,500.00
CLS1856HU	Human high sensitivity C-Reactive Protein,hs-CRP ELISA Kit	96 Test	38220090	24,500.00
CLS1857HU	Human p53 up-regulated modulator of apoptosis,PUMA ELISA Kit	96 Test	38220090	24,500.00
CLS1858HU	Human Factor-related Apoptosis ligand,FASL ELISA Kit	96 Test	38220090	24,500.00
CLS1859HU	Human Factor-related Apoptosis,FAS ELISA Kit	96 Test	38220090	24,500.00
CLS1860HU	Human Pregnancy Specific β 1Glycoprotein,SP1/PS β 1-G ELISA Kit	96 Test	38220090	24,500.00
CLS1861HU	Human anti-cytomegalovirus IgG antibody,anti-CMV IgG ELISA Kit	96 Test	38220090	24,500.00
CLS1862HU	Human α Lactalbumin, α -La ELISA Kit	96 Test	38220090	24,500.00
CLS1863HU	Human pregnancy associated plasma protein A,PAPP-A ELISA Kit	96 Test	38220090	24,500.00
CLS1864HU	Human Lactoferrin,LTF/LF ELISA kit	96 Test	38220090	24,500.00
CLS1865HU	Human heparan sulfate,HS/HPS ELISA Kit	96 Test	38220090	24,500.00
CLS1866HU	human peroxisome proliferative activated receptor gama coactivator 1 alpha,PPARGC1 ELISA Kit	96 Test	38220090	24,500.00
CLS1867HU	Human chondroitin sulfate,CS ELISA Kit	96 Test	38220090	24,500.00
CLS1868HU	Human hydroxyproline,Hyp ELISA Kit	96 Test	38220090	24,500.00
CLS1869HU	Human Homovanillic acid,HVA ELISA Kit	96 Test	38220090	24,500.00
CLS1870HU	Human collectin sub-family member 11,COLEC11 ELISA Kit	96 Test	38220090	24,500.00
CLS1871HU	Human arginine,Arg ELISA Kit	96 Test	38220090	24,500.00
CLS1872HU	Human tumor necrosis factor-related ligand 1A,TL1A ELISA kit	96 Test	38220090	24,500.00
CLS1873HU	Human 11-Beta-Hydroxysteroid Dehydrogenase Type 1 (11BHSD1) ELISA Kit	96 Test	38220090	24,500.00
CLS1874HU	Human HTI-56,HTI-56 ELISA Kit	96 Test	38220090	24,500.00
CLS1875HU	Human major histocompatibility complex class I chain-related gene A,MICA ELISA Kit	96 Test	38220090	24,500.00
CLS1876HU	Human intercellular adhesion molecule 4,ICAM-4 ELISA Kit	96 Test	38220090	24,500.00
CLS1877HU	Human cytokeratin 17,CK-17 ELISA Kit	96 Test	38220090	24,500.00
CLS1878HU	Human Mucin-4,MUC4 ELISA Kit	96 Test	38220090	24,500.00
CLS1879HU	Human translationally controlled tumor protein,TCTP ELISA Kit	96 Test	38220090	24,500.00
CLS1880HU	Human Cyclin-dependent kinase 17,CDK-17 ELISA Kit	96 Test	38220090	24,500.00
CLS1881HU	Human L-Dihydroxyphenylalanine,L-DOPA ELISA Kit	96 Test	38220090	24,500.00
CLS1882HU	Human Interleukin 7,IL-7 ELISA KIT	96 Test	38220090	24,500.00
CLS1883HU	Human Sodium/Glucose Cotransporter 2 (SGLT2)ELISA kit	96 Test	38220090	24,500.00
CLS1884HU	Human X chromosome linked inhibitor of apoptosis protein, XIAP ELISA Kit	96 Test	38220090	24,500.00
CLS1885HU	human T-Subset,T-SUBSET ELISA Kit	96 Test	38220090	24,500.00
CLS1886HU	Human FMS-like tyrosine kinase 1,Flt1 ELISA Kit	96 Test	38220090	24,500.00
CLS1887HU	Human Krebs von den Lundgen-6 (KL-6) ELISA Kit	96 Test	38220090	24,500.00
CLS1888HU	Human Bone morphogenetic protein 2,BMP-2 ELISA Kit	96 Test	38220090	24,500.00

Cat.No.	Product Description	Pack Size	HSN	Unit Price
CLS1889HU	Human Glucose-6-Phosphatase, Catalytic (G6PC)ELISA kit	96 Test	38220090	24,500.00
CLS1890HU	Human Forkhead box O3A,FOXO3A ELISA Kit	96 Test	38220090	24,500.00
CLS1891HU	Human fibinogen degradation product,FDP ELISA Kit	96 Test	38220090	24,500.00
CLS1892HU	Human Papillomavirus Type 18(HPV18)ELISA Kit	96 Test	38220090	24,500.00
CLS1893HU	Human Papillomavirus Type 18 L1(HPV18L1)ELISA Kit	96 Test	38220090	24,500.00
CLS1894HU	Human inosine triphosphate py-rophosphatase,ITPA ELISA Kit	96 Test	38220090	24,500.00
CLS1895HU	Human low molecular-weight protein,LMP7 ELISA Kit	96 Test	38220090	24,500.00
CLS1896HU	Human growth arrest-specific gene-6,gas-6 ELISA Kit	96 Test	38220090	24,500.00
CLS1897HU	Human Esophagus cancer-related gene-2 antibody,ECG2-Ab ELISA Kit	96 Test	38220090	24,500.00
CLS1898HU	Human peptidoglycan,PG ELISA Kit	96 Test	38220090	24,500.00
CLS1899HU	Human Gastrin,GAS ELISA Kit	96 Test	38220090	24,500.00
CLS1900HU	Human papillomaviruse16 E7 protein,HPV16 E7 protein ELISA Kit	96 Test	38220090	24,500.00
CLS1901HU	Human Cotinine(Cotinine)ELISA Kit	96 Test	38220090	24,500.00
CLS1902HU	Human uncoupling protein 2,UCP2 ELISA Kit	96 Test	38220090	24,500.00
CLS1903HU	Human Paraoxonase-3,PON3 ELISA Kit	96 Test	38220090	24,500.00
CLS1904HU	Human Creatine Kinase,CK ELISA Kit	96 Test	38220090	24,500.00
CLS1905HU	Human glial fibrillary acidic protein,GFAP ELISA Kit	96 Test	38220090	24,500.00
CLS1906HU	Human anti-flaggrin antibody,AFA ELISA KIT	96 Test	38220090	24,500.00
CLS1907HU	Human Nerve growth factor,NGF ELISA kit	96 Test	38220090	24,500.00
CLS1908HU	Human squamous cell carcinoma antigen,SCC-Ag ELISA Kit	96 Test	38220090	24,500.00
CLS1909HU	Human natural killer cell(NK)ELISA Kit	96 Test	38220090	24,500.00
CLS1910HU	Human Prohibitin,PHB ELISA Kit	96 Test	38220090	24,500.00
CLS1911HU	Human Thioredoxin-binding protein 2,TBP-2 ELISA kit	96 Test	38220090	24,500.00
CLS1912HU	Human insulin-like growth factors binding protein 5,IGFBP-5 ELISA Kit	96 Test	38220090	24,500.00
CLS1913HU	Human protein carbonyl,PCO ELISA Kit	96 Test	38220090	24,500.00
CLS1914HU	Human Liver Type Fatty Acid Binding Protein(L-FABP) ELISA KIT	96 Test	38220090	24,500.00
CLS1915HU	Human cysteinyl aspartate specific proteinases 8,Caspase-8 ELISA Kit	96 Test	38220090	24,500.00
CLS1916HU	Human uncoupling protein 3, UCP3 ELISA Kit	96 Test	38220090	24,500.00
CLS1917HU	Human Vitamin K2,VK2 ELISA Kit	96 Test	38220090	24,500.00
CLS1918HU	Human anti-platelet antibodies,PA-Ab ELISA Kit	96 Test	38220090	24,500.00
CLS1919HU	Human secreted frizzled-related protein 5(SFRP5) ELISA Kit	96 Test	38220090	24,500.00
CLS1920HU	Human high density lipoprotein2,HDL2 ELISA Kit	96 Test	38220090	24,500.00
CLS1921HU	Human high density lipoprotein3,HDL3 ELISA Kit	96 Test	38220090	24,500.00
CLS1922HU	Human Fascin (FSCN)ELISA Kit	96 Test	38220090	24,500.00
CLS1923HU	Human Mesothelin(MSLN)ELISA Kit	96 Test	38220090	24,500.00
CLS1924HU	Human Steroid 5-Alpha-Reductase 1 (SRD5A1) ELISA Kit	96 Test	38220090	24,500.00
CLS1925HU	Human Selenoprotein-P ,Se-P ELISA Kit	96 Test	38220090	24,500.00
CLS1926HU	Human Total antioxidant capacity,T-AOC ELISA Kit	96 Test	38220090	24,500.00
CLS1927HU	Human Apoptosense-M30(Ap-M30)ELISA Kit	96 Test	38220090	24,500.00
CLS1928HU	Human Matrix Metalloproteinase 23A (MMP23A)ELISA kit	96 Test	38220090	24,500.00
CLS1929HU	Human Lecithin Cholesterol Acyltransferase (LCAT)ELISA kit	96 Test	38220090	24,500.00
CLS1930HU	Human Growth Differentiation Factor 5 (GDF5)ELISA kit	96 Test	38220090	24,500.00
CLS1931HU	Human Carbonic Anhydrase IV (CA4)ELISA kit	96 Test	38220090	24,500.00
CLS1932HU	Human Low Density Lipoprotein Receptor Related Protein 1 (LRP1)ELISA kit	96 Test	38220090	24,500.00
CLS1933HU	Human Claudin 1 (CLDN1)ELISA kit	96 Test	38220090	24,500.00
CLS1934HU	Human Claudin 23 (CLDN23)ELISA kit	96 Test	38220090	24,500.00

Cat.No.	Product Description	Pack Size	HSN	Unit Price
CLS1935HU	Human Secreted Frizzled Related Protein 1 (SFRP1)ELISA kit	96 Test	38220090	24,500.00
CLS1936HU	Human Secreted Frizzled Related Protein 4 (SFRP4)ELISA kit	96 Test	38220090	24,500.00
CLS1937HU	Human Neuromedin B (NMB)ELISA kit	96 Test	38220090	24,500.00
CLS1938HU	Human Wingless Type MMTV Integration Site Family, Member 11 (WNT11)ELISA Kit	96 Test	38220090	24,500.00
CLS1939HU	Human Wingless Type MMTV Integration Site Family, Member 3A (WNT3A)ELISA Kit	96 Test	38220090	24,500.00
CLS1940HU	Human Wingless Type MMTV Integration Site Family, Member 4 (WNT4)ELISA Kit	96 Test	38220090	24,500.00
CLS1941HU	Human Wingless Type MMTV Integration Site Family, Member 1 (WNT1)ELISA Kit	96 Test	38220090	24,500.00
CLS1942HU	Human WNT1 Inducible Signaling Pathway Protein 1 (WISP1)ELISA Kit	96 Test	38220090	24,500.00
CLS1943HU	Human Ghrelin-O-Acyltransferase (GOAT)ELISA Kit	96 Test	38220090	24,500.00
CLS1944HU	Human Stratifin (SFN)ELISA Kit	96 Test	38220090	24,500.00
CLS1945HU	Human ATP Binding Cassette Transporter A2 (ABCA2)ELISA Kit	96 Test	38220090	24,500.00
CLS1946HU	Human Homogentisate-1,2-Dioxygenase (HGD)ELISA Kit	96 Test	38220090	24,500.00
CLS1947HU	Human Ephrin Type A Receptor 1 (EPHA1)ELISA Kit	96 Test	38220090	24,500.00
CLS1948HU	Human Coronin 1B(CORO1B)ELISA Kit	96 Test	38220090	24,500.00
CLS1949HU	Human Carnitine Acylcarnitine Translocase (CACT)ELISA Kit	96 Test	38220090	24,500.00
CLS1950HU	Human Egl Nine Homolog 1 (EGLN1)ELISA Kit	96 Test	38220090	24,500.00
CLS1951HU	Human Sirtuin 3 (SIRT3)ELISA Kit	96 Test	38220090	24,500.00
CLS1952HU	Human Sirtuin 6 (SIRT6)ELISA Kit	96 Test	38220090	24,500.00
CLS1953HU	Human Synaptotagmin XV (SYT15)ELISA Kit	96 Test	38220090	24,500.00
CLS1954HU	Human Zymogen Granule Protein 16 Homolog B (ZG16B)ELISA Kit	96 Test	38220090	24,500.00
CLS1955HU	Human Diacylglycerol-O-Acyltransferase Homolog 2 (DGAT2)ELISA Kit	96 Test	38220090	24,500.00
CLS1956HU	Human Discs, Large Homolog 4 (DLG4)ELISA Kit	96 Test	38220090	24,500.00
CLS1957HU	Human Dynactin 1 (DCTN1)ELISA Kit	96 Test	38220090	24,500.00
CLS1958HU	Human Dynactin 3 (DCTN3)ELISA Kit	96 Test	38220090	24,500.00
CLS1959HU	Human Glycogenin 2 (GYG2)ELISA Kit	96 Test	38220090	24,500.00
CLS1960HU	Human Intellectin 2 (ITLN2)ELISA Kit	96 Test	38220090	24,500.00
CLS1961HU	Human Inter Alpha-Globulin Inhibitor H4 (ITIH4)ELISA Kit	96 Test	38220090	24,500.00
CLS1962HU	Human Inter Alpha-Globulin Inhibitor H1 (ITIH1)ELISA Kit	96 Test	38220090	24,500.00
CLS1963HU	Human Klotho (KL)ELISA Kit	96 Test	38220090	24,500.00
CLS1964HU	Human Cystatin 1 (CST1)ELISA Kit	96 Test	38220090	24,500.00
CLS1965HU	Human Cystatin 4 (CST4)ELISA Kit	96 Test	38220090	24,500.00
CLS1966HU	Human A Disintegrin And Metalloprotease 12 (ADAM12)ELISA Kit	96 Test	38220090	24,500.00
CLS1967HU	Human Angiotensin 1-7 (Ang1-7) ELISA Kit	96 Test	38220090	24,500.00
CLS1968HU	Human Biglycan (BGN)ELISA Kit	96 Test	38220090	24,500.00
CLS1969HU	Human Calmin (CLMN)ELISA Kit	96 Test	38220090	24,500.00
CLS1970HU	Human Capping Protein Muscle Z Line Beta (CAPZb)ELISA Kit	96 Test	38220090	24,500.00
CLS1971HU	Human Cereblon (CRBN)ELISA Kit	96 Test	38220090	24,500.00
CLS1972HU	Human Cochlin (COCH)ELISA Kit	96 Test	38220090	24,500.00
CLS1973HU	Human Coenzyme Q10 Homolog B (COQ10B)ELISA Kit	96 Test	38220090	24,500.00
CLS1974HU	Human Mothers Against Decapentaplegic Homolog 3 (Smad3)ELISA Kit	96 Test	38220090	24,500.00
CLS1975HU	Human Peroxiredoxin 2 (PRDX2)ELISA Kit	96 Test	38220090	24,500.00
CLS1976HU	Human Peroxiredoxin 3 (PRDX3)ELISA Kit	96 Test	38220090	24,500.00
CLS1977HU	Human Restin (RSN)ELISA Kit	96 Test	38220090	24,500.00

Cat.No.	Product Description	Pack Size	HSN	Unit Price
CLS1978HU	Human Calpain 7 (CAPN7)ELISA Kit	96 Test	38220090	24,500.00
CLS1979HU	Human Annexin A5 (ANXA5)ELISA Kit	96 Test	38220090	24,500.00
CLS1980HU	Human Matrix metalloproteinase 23B (MMP23B) ELISA kit	96 Test	38220090	24,500.00
CLS1981HU	Human Transforming Growth Factor Beta 3 (TGFb3) ELISA kit	96 Test	38220090	24,500.00
CLS1982HU	Human Galectin 8 (GAL8) ELISA kit	96 Test	38220090	24,500.00
CLS1983HU	Human Galectin 9 (GAL9) ELISA kit	96 Test	38220090	24,500.00
CLS1984HU	Human Heat Shock 70kDa Protein 1A (HSPA1A)ELISA kit	96 Test	38220090	24,500.00
CLS1985HU	Human Dentin Sialophosphoprotein (DSPP)ELISA Kit	96 Test	38220090	24,500.00
CLS1986HU	Human Islet cell antibody,ICA ELISA Kit	96 Test	38220090	24,500.00
CLS1987HU	Human Mucin-2,MUC2 ELISA Kit	96 Test	38220090	24,500.00
CLS1988HU	Human Integrin β4 (ITB4) ELISA Kit	96 Test	38220090	24,500.00
CLS1989HU	Human cluster of differentiation 26,CD26 ELISA Kit	96 Test	38220090	24,500.00
CLS1990HU	Human cluster of differentiation 28,CD28 ELISA Kit	96 Test	38220090	24,500.00
CLS1991HU	Human Hepatitis C antibody (HCV) ELISA Kit	96 Test	38220090	24,500.00
CLS1992HU	Human Estrone(E1) ELISA Kit	96 Test	38220090	24,500.00
CLS1993HU	Human Thyroid-stimulating hormone receptor antibody (TSHR) ELISA Kit	96 Test	38220090	24,500.00
CLS1994HU	Human ATP Binding Cassette Transporter A3 (ABCA3) ELISA Kit	96 Test	38220090	24,500.00
CLS1995HU	Human Vitamin B1(VB1) ELISA Kit	96 Test	38220090	24,500.00
CLS1996HU	Human Anti-HBV surface Antigen Antibody,Anti-HBV ELISA	96 Test	38220090	24,500.00
CLS1997HU	Human Relaxin-1,RLN-1 ELISA	96 Test	38220090	24,500.00
CLS1998HU	Human Prostaglandin F2,PGF2 ELISA Kit	96 Test	38220090	24,500.00
CLS1999HU	Human Alpha-tocopherol transfer protein (TTPA) ELISA Kit	96 Test	38220090	24,500.00
CLS2000HU	Human Nuclear Matrix Protein 1 (NMP-1) ELISA kit	96 Test	38220090	24,500.00
CLS2001HU	Human Krueppel-like factor 5(KLF5) ELISA Kit	96 Test	38220090	24,500.00
CLS2002HU	Human Extracellular matrix metalloproteinase inducer(EMMPRIN) ELISA kit	96 Test	38220090	24,500.00
CLS2003HU	Human Growth Differentiation Factor 8 (GDF8) ELISA kit	96 Test	38220090	24,500.00
CLS2004HU	Human Growth Differentiation Factor 9 (GDF9) ELISA kit	96 Test	38220090	24,500.00
CLS2005HU	Human Heat Shock Protein 17,HSP-17 ELISA Kit	96 Test	38220090	24,500.00
CLS2006HU	Human Lipase(LIP)ELISA kit	96 Test	38220090	24,500.00
CLS2007HU	Human Zinc finger E-box-binding homeobox 1, ZEB1 ELISA Kit	96 Test	38220090	24,500.00
CLS2008HU	Human Neurokinins B,NKB ELISA Kit	96 Test	38220090	24,500.00
CLS2009HU	Human Elastase 1, Pancreatic(ELA1) ELISA Kit	96 Test	38220090	24,500.00
CLS2010HU	Human Thiopurine Methyltransferase(TPMT) ELISA Kit	96 Test	38220090	24,500.00
CLS2011HU	Human SET domain containing 2, setd2 ELISA Kit	96 Test	38220090	24,500.00
CLS2012HU	Human Interleukin 28,IL-28 ELISA Kit	96 Test	38220090	24,500.00
CLS2013HU	Human N-terminal C-Type Natriuretic Propeptid (NT-proCNP) ELISA Kit	96 Test	38220090	24,500.00
CLS2014HU	Human neuropeptide A,NP-A ELISA Kit	96 Test	38220090	24,500.00
CLS2015HU	Human Neurotrophin 5,NT-5 ELISA KIT	96 Test	38220090	24,500.00
CLS2016HU	Human Renalase(RNLS) ELISA Kit	96 Test	38220090	24,500.00
CLS2017HU	Human fibroblast growth factor 6,FGF6 ELISA Kit	96 Test	38220090	24,500.00
CLS2018HU	Human Dipeptidyl peptidase 3(DPP3) ELISA Kit	96 Test	38220090	24,500.00
CLS2019HU	Human Dipeptidase 2(DPEP2) ELISA Kit	96 Test	38220090	24,500.00
CLS2020HU	Human Kisspeptin 54(KISS-54) ELISA Kit	96 Test	38220090	24,500.00
CLS2021HU	Human Sperm-associated antigen 9(SPAG9) ELISA Kit	96 Test	38220090	24,500.00
CLS2022HU	Human Anti-Luteinizing Hormone(LH-AB)ELISA Kit	96 Test	38220090	24,500.00
CLS2023HU	Human Histidine-proline-rich glycoprotein(HPRG) ELISA Kit	96 Test	38220090	24,500.00
CLS2024HU	Human Endothelin 2,ET-2 ELISA Kit	96 Test	38220090	24,500.00

Cat.No.	Product Description	Pack Size	HSN	Unit Price
CLS2025HU	Human Endothelin 3,ET-3 ELISA Kit	96 Test	38220090	24,500.00
CLS2026HU	Human Fibronectin type III domain-containing protein 5,FNDC5/FRCP2 ELISA Kit	96 Test	38220090	24,500.00
CLS2027HU	Human Perilipin-1(PLIN1)ELISA kit	96 Test	38220090	24,500.00
CLS2028HU	Human Perilipin-2(PLIN2)ELISA kit	96 Test	38220090	24,500.00
CLS2029HU	Human Protein Induced Vitamin K Absence or Antagonist-II(PIVKA-II) ELISA kit	96 Test	38220090	24,500.00
CLS2030HU	Human Glutathione reductase(GR) ELISA kit	96 Test	38220090	24,500.00
CLS2031HU	Human Selenium-binding protein 1,SELENBP1 ELISA kit	96 Test	38220090	24,500.00
CLS2032HU	Human Copper transporter 1,COPT1/SLC31A1 ELISA Kit	96 Test	38220090	24,500.00
CLS2033HU	Human Growth arrest-specific protein 6,GAS6 ELISA Kit	96 Test	38220090	24,500.00
CLS2034HU	Human Fetuin B,FETU-B ELISA Kit	96 Test	38220090	24,500.00
CLS2035HU	Human Annexin A3 (ANXA3)ELISA Kit	96 Test	38220090	24,500.00
CLS2036HU	Human Placenta-specific protein 1,PLAC1 ELISA Kit	96 Test	38220090	24,500.00
CLS2037HU	Human Interleukin-8 receptor Beta,IL8RB/CXCR2 ELISA Kit	96 Test	38220090	24,500.00
CLS2038HU	Human Hormone Binding Protein(HBP)ELISA Kit	96 Test	38220090	24,500.00
CLS2039HU	Human Stromal cell derived factor 1,SDF-1 Elisa kit	96 Test	38220090	24,500.00
CLS2040HU	Human Neuromedin U (NMU)ELISA kit	96 Test	38220090	24,500.00
CLS2041HU	Human Carbohydrate antigen 27-29,CA27-29 ELISA Kit	96 Test	38220090	24,500.00
CLS2042HU	Human betatrophin(betatrophin)ELISA Kit	96 Test	38220090	24,500.00
CLS2043HU	Human Phosphatidylinositol Binding clathrin Assembly Protein(PICALM)ELISA Kit	96 Test	38220090	24,500.00
CLS2044HU	Human 14-3-3 protein eta(YWHAH)ELISA Kit	96 Test	38220090	24,500.00
CLS2045HU	Human L-Carnitine(L-Carnitine)ELISA Kit	96 Test	38220090	24,500.00
CLS2046HU	Human Xanthine Oxidase(XOD)ELISA Kit	96 Test	38220090	24,500.00
CLS2047HU	Human reactive oxygen species(ROS)ELISA Kit	96 Test	38220090	24,500.00
CLS2048HU	Human Probable ATP-dependent RNA helicase DDX20(DDX20)ELISA Kit	96 Test	38220090	24,500.00
CLS2049HU	Human Cathelicidin-1(CATHL1)ELISA Kit	96 Test	38220090	24,500.00
CLS2050HU	Human ADAM metallopeptidase with thrombospondin type 1 motif 5(ADAMTS5)ELISA Kit	96 Test	38220090	24,500.00
CLS2051HU	Human ADAM metallopeptidase with thrombospondin type 1 motif 9(ADAMTS9)ELISA Kit	96 Test	38220090	24,500.00
CLS2052HU	Human ADAM metallopeptidase with thrombospondin type 1 motif 18(ADAMTS18)ELISA Kit	96 Test	38220090	24,500.00
CLS2053HU	human neprilysin(NEP) elisa kit	96 Test	38220090	24,500.00
CLS2054HU	Human TBC1 domain family member 13, TBC1D13 ELISA kit	96 Test	38220090	24,500.00
CLS2055HU	Human Paralemmin(PALM)Elisa kit	96 Test	38220090	24,500.00
CLS2056HU	Human Cyclin D1(CCND1)ELISA Kit	96 Test	38220090	24,500.00
CLS2057HU	Human Tropomyosin alpha-1 chain(TPM1) ELISA kit	96 Test	38220090	24,500.00
CLS2058HU	Human Heme binding protein 1(HEBP1)ELISA kit	96 Test	38220090	24,500.00
CLS2059HU	Human Ubiquitin-conjugating enzyme E2 N(Ube2n)ELISA kit	96 Test	38220090	24,500.00
CLS2060HU	Human Acylamino-acid-releasing enzyme(APEH) ELISA kit	96 Test	38220090	24,500.00
CLS2061HU	Human ATP synthase subunit beta, mitochondrial(ATP5B) ELISA kit	96 Test	38220090	24,500.00
CLS2062HU	Human Fibrinogen Gamma Chain (FGG)ELISA Kit	96 Test	38220090	24,500.00
CLS2063HU	Human 4-trimethylaminobutyraldehyde dehydrogenase(ALDH9A1)ELISA Kit	96 Test	38220090	24,500.00
CLS2064HU	Human 26S protease regulatory subunit 7(PSMC2)ELISA Kit	96 Test	38220090	24,500.00
CLS2065HU	Human Actin, cytoplasmic 2(ACTG1) ELISA kit	96 Test	38220090	24,500.00
CLS2066HU	Human Guanine nucleotide-binding protein G(I)/G(S)/G(T) subunit beta-1(GNB1) ELISA kit	96 Test	38220090	24,500.00
CLS2067HU	Human Guanine nucleotide-binding protein G(I)/G(S)/G(T) subunit beta-2 (GNB2)ELISA kit	96 Test	38220090	24,500.00

Cat.No.	Product Description	Pack Size	HSN	Unit Price
CLS2115HU	Human Myosin light Chain,MLC ELISA Kit	96 Test	38220090	24,500.00
CLS2116HU	Human lambda immunoglobulin light chain, λ -IgLC ELISA Kit	96 Test	38220090	24,500.00
CLS2117HU	Human immunoglobulin joining chain,Ig-j ELISA Kit	96 Test	38220090	24,500.00
CLS2118HU	Human immunoglobulin heavy chain variable region,IgHV ELISA Kit	96 Test	38220090	24,500.00
CLS2119HU	Human immunoglobulin heavy chain,IgH ELISA Kit	96 Test	38220090	24,500.00
CLS2120HU	Human myosin heavy chain,MHC ELISA Kit	96 Test	38220090	24,500.00
CLS2121HU	Human leukocyte Selectin,L-Selectin ELISA kit	96 Test	38220090	24,500.00
CLS2122HU	Human Platelet-Derived Growth Factor Soluble Receptor α ,PDGFsR- α ELISA kit	96 Test	38220090	24,500.00
CLS2123HU	Human Activated Leukocyte Cell Adhesion Molecule,ALCAM ELISA Kit	96 Test	38220090	24,500.00
CLS2124HU	Human Soluble Cluster of differentiation 30 ligand,sCD30L ELISA Kit	96 Test	38220090	24,500.00
CLS2125HU	Human soluble interleukin-1 receptor I ,IL-1sR I ELISA kit	96 Test	38220090	24,500.00
CLS2126HU	Human soluble interleukin-1 receptor II ,IL-1sR II ELISA kit	96 Test	38220090	24,500.00
CLS2127HU	Human soluble interleukin-2 receptor,IL-2sR β ELISA kit	96 Test	38220090	24,500.00
CLS2128HU	Human lymphocyte function associated antigen 3,LFA-3 ELISA Kit	96 Test	38220090	24,500.00
CLS2129HU	Human soluble platelet-selectin,sP-selectin ELISA Kit	96 Test	38220090	24,500.00
CLS2130HU	Human soluble adhesion molecules,Sam ELISA Kit	96 Test	38220090	24,500.00
CLS2131HU	Human T cell receptor $\gamma\delta$,TCR $\gamma\delta$ ELISA Kit	96 Test	38220090	24,500.00
CLS2132HU	Human Receptor II for the Fc region of immunoglobulin E,Fc ϵ R II ELISA Kit	96 Test	38220090	24,500.00
CLS2133HU	Human soluble vascular endothelial growth factor receptor-3,sVEGFR-3/sFLT-4 ELISA Kit	96 Test	38220090	24,500.00
CLS2134HU	Human Receptor I for the Fc region of immunoglobulin A,Fc α R I ELISA Kit	96 Test	38220090	24,500.00
CLS2135HU	Human insulin-like growth factors 2 receptor,IGF-2R ELISA Kit	96 Test	38220090	24,500.00
CLS2136HU	Human Macrophage Colony-Stimulating Factor Receptor,M-CSFR/CD115 ELISA Kit	96 Test	38220090	24,500.00
CLS2137HU	Human cluster of differentiation 8,CD8 ELISA Kit	96 Test	38220090	24,500.00
CLS2138HU	human leukocyte immunoglobulin-like receptor subfamily B member 4,LILRB4 ELISA Kit	96 Test	38220090	24,500.00
CLS2139HU	Human soluble cluster of differentiation 44 variant 9,sCD44-v9 ELISA Kit	96 Test	38220090	24,500.00
CLS2140HU	Human glucoprotein 130,gp130/CD130 ELISA KIT	96 Test	38220090	24,500.00
CLS2141HU	Human CXC-chemokine receptor 3,CXCR3 ELISA Kit	96 Test	38220090	24,500.00
CLS2142HU	Human anti-thrombin receptor,ATR ELISA Kit	96 Test	38220090	24,500.00
CLS2143HU	Human intercellular adhesion molecule 3,ICAM-3 ELISA Kit	96 Test	38220090	24,500.00
CLS2144HU	Human B cell activation factor from the tumor necrosis factor family receptor,BAFF-R ELISA Kit	96 Test	38220090	24,500.00
CLS2145HU	Human Vascular Endothelial-Cadherin Complex,VE-cad ELISA Kit	96 Test	38220090	24,500.00
CLS2146HU	Human polyimmunoglobulinreceptor,poly-IgR ELISA Kit	96 Test	38220090	24,500.00
CLS2147HU	Human asialoglyco protein receptor,ASGPR ELISA Kit	96 Test	38220090	24,500.00
CLS2148HU	Human cutaneous lymphocyte-associated antigen,CLA ELISA Kit	96 Test	38220090	24,500.00
CLS2149HU	Human soluble cytokine receptor,sCKR ELISA Kit	96 Test	38220090	24,500.00
CLS2150HU	Human Placenta Cadherin,P-cad ELISA Kit	96 Test	38220090	24,500.00
CLS2151HU	Human Receptor I for the Fc region of immunoglobulin E,Fc ϵ R I ELISA Kit	96 Test	38220090	24,500.00
CLS2152HU	Human glycosylation-dependent cell adhesion molecule-1,GlyCAM-1 ELISA Kit	96 Test	38220090	24,500.00
CLS2153HU	Human costimulatory molecules recptor,CMR ELISA Kit	96 Test	38220090	24,500.00
CLS2154HU	Human B cell receptor,BCR ELISA Kit	96 Test	38220090	24,500.00

Cat.No.	Product Description	Pack Size	HSN	Unit Price
CLS2155HU	Human killer cell lectin-like receptor,KLR ELISA Kit	96 Test	38220090	24,500.00
CLS2156HU	Human Soluble Cluster of differentiation 38,sCD38 ELISA Kit	96 Test	38220090	24,500.00
CLS2157HU	Human Soluble Cluster of differentiation 21,sCD21 ELISA Kit	96 Test	38220090	24,500.00
CLS2158HU	Human Neural-Cadherin, N-Cad ELISA kit	96 Test	38220090	24,500.00
CLS2159HU	Human Interferon α/β Receptor,IFN- α/β R ELISA Kit	96 Test	38220090	24,500.00
CLS2160HU	Human Epithelial Cell Adhesion Molecule,Ep-CAM ELISA Kit	96 Test	38220090	24,500.00
CLS2161HU	Human Integrin α M,ITG/CD11b ELISA Kit	96 Test	38220090	24,500.00
CLS2162HU	Human CC Chemokine receptor 6,CCR-6 ELISA Kit	96 Test	38220090	24,500.00
CLS2163HU	Human specific macrophage arming factor,SMAF ELISA Kit	96 Test	38220090	24,500.00
CLS2164HU	Human mannose receptor,MR ELISA Kit	96 Test	38220090	24,500.00
CLS2165HU	Human Complement 7,C7 ELISA Kit	96 Test	38220090	24,500.00
CLS2166HU	Human Complement fragment 3c,C3c ELISA Kit	96 Test	38220090	24,500.00
CLS2167HU	Human circulating immune complex,CIC ELISA Kit	96 Test	38220090	24,500.00
CLS2168HU	Human toxic shock syndrome toxin,TSST-1 ELISA Kit	96 Test	38220090	24,500.00
CLS2169HU	Human pokeweed mitogen,PWM ELISA Kit	96 Test	38220090	24,500.00
CLS2170HU	Human Collectin ELISA Kit	96 Test	38220090	24,500.00
CLS2171HU	Human Stathmin 3 (STMN3)ELISA Kit	96 Test	38220090	24,500.00
CLS2172HU	Human Complement component 8,C8 ELISA kit	96 Test	38220090	24,500.00
CLS2173HU	Human platelet-associated Complement 3,PAC3 ELISA Kit	96 Test	38220090	24,500.00
CLS2174HU	Human Complement 3 split product,C3SP ELISA Kit	96 Test	38220090	24,500.00
CLS2175HU	Human Complement fragment 5b,C5b ELISA Kit	96 Test	38220090	24,500.00
CLS2176HU	Human Complement fragment 4b,C4b ELISA Kit	96 Test	38220090	24,500.00
CLS2177HU	Human ribosome-inactivating proteins,RIPs ELISA Kit	96 Test	38220090	24,500.00
CLS2178HU	Human complement factor B,CFB ELISA Kit	96 Test	38220090	24,500.00
CLS2179HU	Human Hemolytic complement,Hc ELISA Kit	96 Test	38220090	24,500.00
CLS2180HU	Human Complement 1 inhibitor autoantibody,C1INH ELISA Kit	96 Test	38220090	24,500.00
CLS2181HU	Human Complement fragment 3b rccptor,C3bR ELISA Kit	96 Test	38220090	24,500.00
CLS2182HU	Human insulin-like growth factors binding protein 2,IGFBP-2 ELISA Kit	96 Test	38220090	24,500.00
CLS2183HU	Human Alternative macrophage activation-associated CC chemokine 1,AmAC-1 ELISA Kit	96 Test	38220090	24,500.00
CLS2184HU	Human Thymopentin,TP-5 ELISA Kit	96 Test	38220090	24,500.00
CLS2185HU	Human factor B,BF ELISA Kit	96 Test	38220090	24,500.00
CLS2186HU	Human keratinocyte autocrine factor/Amphiregulin,KAF/AR ELISA Kit	96 Test	38220090	24,500.00
CLS2187HU	Human beta-arrestin,ARRB ELISA Kit	96 Test	38220090	24,500.00
CLS2188HU	Human Epiregulin,EPR ELISA Kit	96 Test	38220090	24,500.00
CLS2189HU	Human transforming growth factor-beta-stimulated Protein clone-22,TSC22 ELISA Kit	96 Test	38220090	24,500.00
CLS2190HU	Human protein phosphatase 1 regulatory subunit A,PPP1R1A ELISA Kit	96 Test	38220090	24,500.00
CLS2191HU	Human TGF-beta-inducible early response gene-1,TIEG1 ELISA Kit	96 Test	38220090	24,500.00
CLS2192HU	Human Non-Phosphorylated Insulin-like growth factor binding protein 1 ELISA Kit	96 Test	38220090	24,500.00
CLS2193HU	Human insulin-like growth factors binding protein 4,IGFBP-4 ELISA Kit	96 Test	38220090	24,500.00
CLS2194HU	Human transporter associated with antigen processing,TAP ELISA Kit	96 Test	38220090	24,500.00
CLS2195HU	Human beta-arrestin 2,ARRB2 ELISA Kit	96 Test	38220090	24,500.00
CLS2196HU	human interferon-stimulated protein,ISP ELISA Kit	96 Test	38220090	24,500.00
CLS2197HU	Human Thymosin ELISA Kit	96 Test	38220090	24,500.00
CLS2198HU	human interferon regulatory factor 8,IRF8 ELISA Kit	96 Test	38220090	24,500.00
CLS2199HU	Human arabinogalactan proteins,AGPs ELISA Kit	96 Test	38220090	24,500.00

Cat.No.	Product Description	Pack Size	HSN	Unit Price
CLS2200HU	Human Estrogen-induced protein pS2,pS2 ELISA Kit	96 Test	38220090	24,500.00
CLS2201HU	Human α 2-plasmin inhibitor, α 2-PI ELISA Kit	96 Test	38220090	24,500.00
CLS2202HU	Human macrophage stimulating protein,MSP ELISA Kit	96 Test	38220090	24,500.00
CLS2203HU	Human placental ribonuclease inhibitor,HPRI ELISA Kit	96 Test	38220090	24,500.00
CLS2204HU	Human interferon Regulatory Factor 1,IRF1 ELISA Kit	96 Test	38220090	24,500.00
CLS2205HU	Human complement control protein,CCP ELISA Kit	96 Test	38220090	24,500.00
CLS2206HU	Human leukoregulin,LR ELISA Kit	96 Test	38220090	24,500.00
CLS2207HU	Human anti-lymphocyte globulin,ALG ELISA Kit	96 Test	38220090	24,500.00
CLS2208HU	Human major histocompatibility complex III,MHC III/HLA-III ELISA Kit	96 Test	38220090	24,500.00
CLS2209HU	Human major histocompatibility complex I,MHC I /HLA I ELISA Kit	96 Test	38220090	24,500.00
CLS2210HU	Human peptide major histocompatibility complex,pMHC ELISA Kit	96 Test	38220090	24,500.00
CLS2211HU	Human Protein lin-28 homolog B(LIN28B)ELISA Kit	96 Test	38220090	24,500.00
CLS2212HU	Human leukocyte antigen E,HLA-E ELISA Kit	96 Test	38220090	24,500.00
CLS2213HU	Human rheumatoid arthritis associated nuclear antigen,RANA ELISA Kit	96 Test	38220090	24,500.00
CLS2214HU	Human anti-brain tissue antibody,ABAb ELISA Kit	96 Test	38220090	24,500.00
CLS2215HU	Human anti-chromosome antibody ELISA Kit	96 Test	38220090	24,500.00
CLS2216HU	Human anti-parotid duct antibody ELISA Kit	96 Test	38220090	24,500.00
CLS2217HU	Human anti-liver cell membrane antibody,LMA ELISA Kit	96 Test	38220090	24,500.00
CLS2218HU	Human anti-red cell antibody ELISA Kit	96 Test	38220090	24,500.00
CLS2219HU	Human anti-macrophage antibody ELISA Kit	96 Test	38220090	24,500.00
CLS2220HU	Human alveoli basement membrane zone antibody,ABM-Ab ELISA Kit	96 Test	38220090	24,500.00
CLS2221HU	Human anti-thymocyte globulin,ATG ELISA Kit	96 Test	38220090	24,500.00
CLS2222HU	Human epidermal basement membrane zone,EBMZ ELISA Kit	96 Test	38220090	24,500.00
CLS2223HU	Human anti-liver cytosolantibody type 1,LC1 ELISA Kit	96 Test	38220090	24,500.00
CLS2224HU	Human 28S ribosome RNP antibody,28S rRNP ELISA Kit	96 Test	38220090	24,500.00
CLS2225HU	Human signal recognition particle antibody,SRP ELISA Kit	96 Test	38220090	24,500.00
CLS2226HU	Human anti-glycolipid autoantibody,AGA ELISA Kit	96 Test	38220090	24,500.00
CLS2227HU	Human autoantibodies against the C-terminal domain IV,ACAST-DIV ELISA Kit	96 Test	38220090	24,500.00
CLS2228HU	Human systemic lupus erythematosus,SLE ELISA Kit	96 Test	38220090	24,500.00
CLS2229HU	Human anti-cell membrane DNA antibody,cmDNA ELISA Kit	96 Test	38220090	24,500.00
CLS2230HU	Human anti-fibrillar antibody,AFA/snoRNP/U3RNP ELISA Kit	96 Test	38220090	24,500.00
CLS2231HU	Human granulocyte specific antinuclear antibody,GS-ANA ELISA Kit	96 Test	38220090	24,500.00
CLS2232HU	Human anti-growth hormone antibody,GHAb ELISA Kit	96 Test	38220090	24,500.00
CLS2233HU	Human anti-Reticulin antibody,ARA ELISA Kit	96 Test	38220090	24,500.00
CLS2234HU	Human anti-centrol and centrosome antibody,ACA ELISA Kit	96 Test	38220090	24,500.00
CLS2235HU	human phosphatidylinositol antibody IgG/IgM,PI Ab-IgG/IgM ELISA Kit	96 Test	38220090	24,500.00
CLS2236HU	Human Lactoferrin antibody IgG,LF/LTF Ab-IgG ELISA kit	96 Test	38220090	24,500.00
CLS2237HU	Human anti-alpha-Fodrin IgG/IgA, α -Fodrin IgG/IgA ELISA Kit	96 Test	38220090	24,500.00
CLS2238HU	human single stranded DNA Antibody,ssDNA ELISA Kit	96 Test	38220090	24,500.00
CLS2239HU	Human SS-A/Ro antibody ELISA Kit	96 Test	38220090	24,500.00
CLS2240HU	Human anti-double stranded DNA,dsDNA ELISA KIT	96 Test	38220090	24,500.00
CLS2241HU	Human interferon-inducible protein 16 autoantibody,IFI16 ELISA Kit	96 Test	38220090	24,500.00
CLS2242HU	Human anti-cardiolipin antibody IgG,ACA-IgG ELISA Kit	96 Test	38220090	24,500.00
CLS2243HU	Human tubular basement membrane antibody,TBM ELISA Kit	96 Test	38220090	24,500.00

Cat.No.	Product Description	Pack Size	HSN	Unit Price
CLS2244HU	Human anti-prothrombins antibodies,aPT1/aPT2 ELISA Kit	96 Test	38220090	24,500.00
CLS2245HU	Human β 2-glycoprotein 1 antibody IgA/G/M, β 2-GP1 IgA/G/M ELISA Kit	96 Test	38220090	24,500.00
CLS2246HU	Human glomerular basement membrane antibody,GBM ELISA Kit	96 Test	38220090	24,500.00
CLS2247HU	Human Anti-proteinase 3 antibody IgG,PR3 Ab-IgG ELISA Kit	96 Test	38220090	24,500.00
CLS2248HU	Human histone H2A-H2B-DNA autoantibody ELISA Kit	96 Test	38220090	24,500.00
CLS2249HU	Human SS-B/La Antibody,ELISA Kit	96 Test	38220090	24,500.00
CLS2250HU	Human β 2-Glycoprotein 1 antibody IgA, β 2-GP1 Ab IgA ELISA Kit	96 Test	38220090	24,500.00
CLS2251HU	Human β 2-Glycoprotein 1 Antibody IgG, β 2-GP1 Ab IgG ELISA Kit	96 Test	38220090	24,500.00
CLS2252HU	Human anti-cardiolipin antibody IgA,ACA-IgA ELISA Kit	96 Test	38220090	24,500.00
CLS2253HU	Human anti-IVIgG antibody ELISA Kit	96 Test	38220090	24,500.00
CLS2254HU	Human Anti-myocardial antibody,AMA ELISA Kit	96 Test	38220090	24,500.00
CLS2255HU	human Anti-thyroid-globulin antibody,ATGA ELISA KIT	96 Test	38220090	24,500.00
CLS2256HU	Human platelet antibodies IgG/M/A,PA-IgG/M/A ELISA Kit	96 Test	38220090	24,500.00
CLS2257HU	Human anti-ribosomal P protein antibody,ARPA/Rib-P ELISA Kit	96 Test	38220090	24,500.00
CLS2258HU	Human Extractable nuclear antigen,ENA ELISA Kit	96 Test	38220090	24,500.00
CLS2259HU	Human Anti-Skin Antibody,ASA ELISA Kit	96 Test	38220090	24,500.00
CLS2260HU	Human Anti-Somatic Muscle Antibody,ASA ELISA Kit	96 Test	38220090	24,500.00
CLS2261HU	Human salivary duct autoantibody,SDA ELISA Kit	96 Test	38220090	24,500.00
CLS2262HU	Human mitotic spindle apparatus antibody,MSA ELISA Kit	96 Test	38220090	24,500.00
CLS2263HU	Human anti-extractable nuclear antigen antibody,ENA-Ab ELISA Kit	96 Test	38220090	24,500.00
CLS2264HU	Human Proteinase 3 Antibody,PR3Ab ELISA Kit	96 Test	38220090	24,500.00
CLS2265HU	Human anti-soluble liver antigen,SLA ELISA Kit	96 Test	38220090	24,500.00
CLS2266HU	Human β anti-galactan proteins IgG ELISA Kit	96 Test	38220090	24,500.00
CLS2267HU	Human anti-glycoprotein antibody,GP ELISA Kit	96 Test	38220090	24,500.00
CLS2268HU	Human anti-Monocyte antibody,AMA ELISA Kit	96 Test	38220090	24,500.00
CLS2269HU	Human anti-EJ-antibody · EJ/GlyRS ELISA Kit	96 Test	38220090	24,500.00
CLS2270HU	Human proliferating cell nuclear antigen antibody,PCNA ELISA Kit	96 Test	38220090	24,500.00
CLS2271HU	Human Thyroxine antibody,TAb ELISA Kit	96 Test	38220090	24,500.00
CLS2272HU	Human Platelet associated antibody,PA-IgM ELISA Kit	96 Test	38220090	24,500.00
CLS2273HU	Human anti-Histone antibody,AHA ELISA Kit	96 Test	38220090	24,500.00
CLS2274HU	Human anti-trophoblast antibody,ATA ELISA Kit	96 Test	38220090	24,500.00
CLS2275HU	Human Anticentromere Antibody,ACA/CENP ELISA Kit	96 Test	38220090	24,500.00
CLS2276HU	Human Paraneoplastic pemphigus,PNP ELISA Kit	96 Test	38220090	24,500.00
CLS2277HU	Human Collagen autoantibody,CLA ELISA Kit	96 Test	38220090	24,500.00
CLS2278HU	Human Semaphorin 4B (SEMA4B)ELISA Kit	96 Test	38220090	24,500.00
CLS2279HU	Human anti-cyclic citrullinated peptide,CCP ELISA Kit	96 Test	38220090	24,500.00
CLS2280HU	Human Interferon α Antibody,IFN α -Ab ELISA Kit	96 Test	38220090	24,500.00
CLS2281HU	Human Sc1-70 Antibody,Sc1-70-Ab ELISA Kit	96 Test	38220090	24,500.00
CLS2282HU	Human Jo-1 Antibody,Jo1/HRS ELISA Kit	96 Test	38220090	24,500.00
CLS2283HU	Human anti-ribonucleo protein Antibody,RNP-Ab ELISA Kit	96 Test	38220090	24,500.00
CLS2284HU	Human anti-albumin antibody,AAA ELISA Kit	96 Test	38220090	24,500.00
CLS2285HU	Human anti-sp100-antibody ELISA Kit	96 Test	38220090	24,500.00
CLS2286HU	Human purkinje cell autoantibody,PCA-1/Yo ELISA Kit	96 Test	38220090	24,500.00
CLS2287HU	Human anti-Sa-antibody ELISA Kit	96 Test	38220090	24,500.00
CLS2288HU	Human neuronal nuclear autoantibody,ANNA-2/Ri ELISA Kit	96 Test	38220090	24,500.00
CLS2289HU	Human heterogeneous nuclear ribonucleoprotein compies/anti-RA33-antibody,hnRNP/RA33 ELISA Kit	96 Test	38220090	24,500.00
CLS2290HU	Human polymyositis-sclerosis antibody,PM-ScI/PM-1 ELISA Kit	96 Test	38220090	24,500.00

Cat.No.	Product Description	Pack Size	HSN	Unit Price
CLS2291HU	Human anti-PL7-antibody ELISA Kit	96 Test	38220090	24,500.00
CLS2292HU	Human anti-PL12-antibody,PL12/AlaRS ELISA Kit	96 Test	38220090	24,500.00
CLS2293HU	Human anti-Mi2-antibody ELISA Kit	96 Test	38220090	24,500.00
CLS2294HU	Human anti-Ku-antibody ELISA Kit	96 Test	38220090	24,500.00
CLS2295HU	Human anti-IgA antibody ELISA Kit	96 Test	38220090	24,500.00
CLS2296HU	Human neuronal nuclear autoantibody,ANNA-1/Hu ELISA Kit	96 Test	38220090	24,500.00
CLS2297HU	Human anti-Bullous Pemphigoid 180 antibody,BP180-Ab ELISA Kit	96 Test	38220090	24,500.00
CLS2298HU	Human anti-B burgdorferi antibody,BB-Ab ELISA Kit	96 Test	38220090	24,500.00
CLS2299HU	Human liver specific lipoprotein,LSP ELISA Kit	96 Test	38220090	24,500.00
CLS2300HU	Human Anti-phosphatidyl serine antibody,APSA ELISA Kit	96 Test	38220090	24,500.00
CLS2301HU	Human anti-lymphocytotoxic antibody,ALA/LCA ELISA Kit	96 Test	38220090	24,500.00
CLS2302HU	Human Anti-glucoprotein 210,GP210 ELISA Kit	96 Test	38220090	24,500.00
CLS2303HU	Human Anti-adrenocortical antibody,AAA ELISA Kit	96 Test	38220090	24,500.00
CLS2304HU	Human anti-single stranded DNA Antibody,ssDNA IgM ELISA Kit	96 Test	38220090	24,500.00
CLS2305HU	Human anti-double stranded DNA,dsDNA IgM ELISA Kit	96 Test	38220090	24,500.00
CLS2306HU	Human anti-single stranded DNA Antibody,ssDNA IgA ELISA Kit	96 Test	38220090	24,500.00
CLS2307HU	Human anti-double stranded DNA,dsDNA IgA ELISA Kit	96 Test	38220090	24,500.00
CLS2308HU	Human anti-Gliadin IgM ELISA kit	96 Test	38220090	24,500.00
CLS2309HU	Human Anti-titin Antibody,TTN ELISA Kit	96 Test	38220090	24,500.00
CLS2310HU	Human anti-presynaptic membrane antibody,PsmAb ELISA Kit	96 Test	38220090	24,500.00
CLS2311HU	Human angiotensin II receptor 1 Antibody,AT II R1 Ab ELISA Kit	96 Test	38220090	24,500.00
CLS2312HU	Human angiotensin I receptor Antibody,ANG- I R antibody ELISA Kit	96 Test	38220090	24,500.00
CLS2313HU	Human anti-calmodulin specific antibody,CaM-ab ELISA Kit	96 Test	38220090	24,500.00
CLS2314HU	Human thyroid hormone autoantibodies,THAA ELISA Kit	96 Test	38220090	24,500.00
CLS2315HU	Human steroid producing cell autoantibody,SCA ELISA Kit	96 Test	38220090	24,500.00
CLS2316HU	Human c-jun ELISA Kit	96 Test	38220090	24,500.00
CLS2317HU	Human Connexin,Cx ELISA Kit	96 Test	38220090	24,500.00
CLS2318HU	Human activating transcription factor-1,ATF-1 ELISA Kit	96 Test	38220090	24,500.00
CLS2319HU	Human forkhead box O2,FOXO2 ELISA Kit	96 Test	38220090	24,500.00
CLS2320HU	Human forkhead box O4,FOXO4 ELISA Kit	96 Test	38220090	24,500.00
CLS2321HU	Human homeobox B2,HOXB2 ELISA Kit	96 Test	38220090	24,500.00
CLS2322HU	Human ponticulin ELISA Kit	96 Test	38220090	24,500.00
CLS2323HU	Human STEAP family member 4,Steap4 ELISA Kit	96 Test	38220090	24,500.00
CLS2324HU	Human Protein inhibitor of activated STAT3,PIAS3 ELISA Kit	96 Test	38220090	24,500.00
CLS2325HU	Human DNA Binding Protein,DBP ELISA Kit	96 Test	38220090	24,500.00
CLS2326HU	Human GTPase activating protein,GAP ELISA Kit	96 Test	38220090	24,500.00
CLS2327HU	Human Mothers against decapentaplegic homolog 7,Smad7 ELISA Kit	96 Test	38220090	24,500.00
CLS2328HU	Human SH2-containing protein,SHC/SLP-76 ELISA Kit	96 Test	38220090	24,500.00
CLS2329HU	Human Guanine nucleotide dissociation Inhibitor,GDI ELISA Kit	96 Test	38220090	24,500.00
CLS2330HU	human frizzled homolog 8,FZD8 ELISA Kit	96 Test	38220090	24,500.00
CLS2331HU	human SET domain containing 4,setd4 ELISA Kit	96 Test	38220090	24,500.00
CLS2332HU	Human TATA box binding protein/TBP-associated factors,TAF ELISA Kit	96 Test	38220090	24,500.00
CLS2333HU	Human GATA binding protein 4,GATA4 ELISA Kit	96 Test	38220090	24,500.00
CLS2334HU	Human Traf2 binding protein,T2BP ELISA Kit	96 Test	38220090	24,500.00
CLS2335HU	human signal transducer and activator of transcription 6,STAT6 ELISA Kit	96 Test	38220090	24,500.00
CLS2336HU	human basic leucine zipper transcription factor ATF-like 2,BATF ELISA Kit	96 Test	38220090	24,500.00

Cat.No.	Product Description	Pack Size	HSN	Unit Price
CLS2337HU	Human protein(peptidylprolyl cis/trans isomerase)NIMA-interacting 1,PIN1 ELISA Kit	96 Test	38220090	24,500.00
CLS2338HU	human signal transducer and activator of transcription 8,STAT8 ELISA Kit	96 Test	38220090	24,500.00
CLS2339HU	Human signal transducer and activator of transcription 1,STAT1 ELISA Kit	96 Test	38220090	24,500.00
CLS2340HU	Human ankyrin B,Ank-B ELISA Kit	96 Test	38220090	24,500.00
CLS2341HU	Human aryl hydrocarbon receptor,AhR ELISA Kit	96 Test	38220090	24,500.00
CLS2342HU	Human dynamin 2,DNM2 ELISA Kit	96 Test	38220090	24,500.00
CLS2343HU	Human A kinase PRKA anchor protein-gravin 12,Akap12 ELISA Kit	96 Test	38220090	24,500.00
CLS2344HU	Human general transcription complex,GTC ELISA Kit	96 Test	38220090	24,500.00
CLS2345HU	Human octamer transcription factor 2B,OTF2B ELISA Kit	96 Test	38220090	24,500.00
CLS2346HU	Human octamer transcription factor 2A,OTF2A ELISA Kit	96 Test	38220090	24,500.00
CLS2347HU	Human ICE protease-activating factor,IRAP ELISA Kit	96 Test	38220090	24,500.00
CLS2348HU	Human cyclophilin A,CyPA ELISA Kit	96 Test	38220090	24,500.00
CLS2349HU	Human chaperonin 10,CPN10 ELISA Kit	96 Test	38220090	24,500.00
CLS2350HU	Human cell division cycle gene,CDC ELISA Kit	96 Test	38220090	24,500.00
CLS2351HU	human signal transducer and activator of transcription 2,STAT2 ELISA Kit	96 Test	38220090	24,500.00
CLS2352HU	human STEAP family member 1,Steap1 ELISA Kit	96 Test	38220090	24,500.00
CLS2353HU	human membrane-spanning 4-domains subfamily A member 11,MS4A11 ELISA Kit	96 Test	38220090	24,500.00
CLS2354HU	Human sonic hedgehog N-Terminus,Shh-N ELISA Kit	96 Test	38220090	24,500.00
CLS2355HU	Human Rho-associated coiled-coil containing protein kinase 2,Rock-2 ELISA Kit	96 Test	38220090	24,500.00
CLS2356HU	Human nuclear factor of kappa light polypeptide gene enhancer in B-cells inhibitor epsilon,Nfkbie	96 Test	38220090	24,500.00
CLS2357HU	Human inhibitory subunit of NF- κ B α ,IKB α ELISA Kit	96 Test	38220090	24,500.00
CLS2358HU	Human cofilin-2,CFL2 ELISA Kit	96 Test	38220090	24,500.00
CLS2359HU	human phospho-inhibitory subunit of NF- κ B α ,pIKB α ELISA kit	96 Test	38220090	24,500.00
CLS2360HU	Human Dynamin 1,DNM1 ELISA kit	96 Test	38220090	24,500.00
CLS2361HU	human signal transducer and activator of transcription 7,STAT7 ELISA Kit	96 Test	38220090	24,500.00
CLS2362HU	Human G protein-coupled receptor 109A,GPR109A ELISA Kit	96 Test	38220090	24,500.00
CLS2363HU	human excision repair cross-complementation group 1,ERCC1 ELISA kit	96 Test	38220090	24,500.00
CLS2364HU	Human Eukaryotic translation initiation factor 3a,eIF3a ELISA Kit	96 Test	38220090	24,500.00
CLS2365HU	Huamn TALIN2(TLN-2) ELISA kit	96 Test	38220090	24,500.00
CLS2366HU	Human platelet-activating factor acetylhydrolase,PAFA ELISA Kit	96 Test	38220090	24,500.00
CLS2367HU	Human Arylalkylamine N-acetyltransferase,AA-NAT ELISA Kit	96 Test	38220090	24,500.00
CLS2368HU	Human protein kinase K9,PKK9 ELISA Kit	96 Test	38220090	24,500.00
CLS2369HU	Human α ketoglutarate dehydrogenase, α -KGDHC ELISA Kit	96 Test	38220090	24,500.00
CLS2370HU	Human fumarase/fumarate hydratase,FUM ELISA Kit	96 Test	38220090	24,500.00
CLS2371HU	human Inhibitor of KB kinase β ,IKK β ELISA kit	96 Test	38220090	24,500.00
CLS2372HU	Human mannan binding lectin associated serine protease,MASP ELISA Kit	96 Test	38220090	24,500.00
CLS2373HU	Human oxidosqualene cyclase,OSC ELISA Kit	96 Test	38220090	24,500.00
CLS2374HU	Human aryl sulfatase A,ASA ELISA Kit	96 Test	38220090	24,500.00
CLS2375HU	Human galactose-6-sulphate sulphatase,Gal-6S ELISA Kit	96 Test	38220090	24,500.00
CLS2376HU	human hexokinase 3,HK3 ELISA Kit	96 Test	38220090	24,500.00
CLS2377HU	human eosinophil-associated ribonuclease A family member 3,EAR3 ELISA Kit	96 Test	38220090	24,500.00

Cat.No.	Product Description	Pack Size	HSN	Unit Price
CLS2378HU	human eosinophil-associated ribonuclease A family member 2 ELISA Kit	96 Test	38220090	24,500.00
CLS2379HU	human dihydropyrimidinase-like 3,DPYSL3 ELISA Kit	96 Test	38220090	24,500.00
CLS2380HU	Human phosphofructokinase-platelet,PFKP ELISA Kit	96 Test	38220090	24,500.00
CLS2381HU	human caspase 4-apoptosis-related cysteine peptidase,Casp4 ELISA Kit	96 Test	38220090	24,500.00
CLS2382HU	human pyridoxal/pyridoxine vitamin B6-kinase,PDXK ELISA Kit	96 Test	38220090	24,500.00
CLS2383HU	human dihydropyrimidinase-like 2,DPYSL2 ELISA Kit	96 Test	38220090	24,500.00
CLS2384HU	human serum/glucocorticoid regulated kinase 2,SGK2 ISA KIT	96 Test	38220090	24,500.00
CLS2385HU	human mitogen activated protein kinase kinase 6,MKK6 ELISA Kit	96 Test	38220090	24,500.00
CLS2386HU	Human T-cell specific GTPase,Tgtp ELISA Kit	96 Test	38220090	24,500.00
CLS2387HU	Human Semaphorin 6C (SEMA6C)ELISA Kit	96 Test	38220090	24,500.00
CLS2388HU	Human farnesyl-diphosphate farnesyltransferase 1,FDFT1 ELISA Kit	96 Test	38220090	24,500.00
CLS2389HU	Human Phosphorylated acetyl CoA,PaCoA ELISA Kit	96 Test	38220090	24,500.00
CLS2390HU	Human phosphoglycerate mutase 2,PGAM2 ELISA Kit	96 Test	38220090	24,500.00
CLS2391HU	Human peptidylprolyl isomerase(cyclophilin)-like 1,PPIL1 ELISA Kit	96 Test	38220090	24,500.00
CLS2392HU	Human mitogen-activated protein kinase-activated protein kinase 3,MAPKAPK3 ELISA Kit	96 Test	38220090	24,500.00
CLS2393HU	Human beta-site APP-cleaving enzyme 2,BACE2 ELISA Kit	96 Test	38220090	24,500.00
CLS2394HU	human receptor TNFRSF-interacting serine-threonine kinase 2,RIPK2 ELISA Kit	96 Test	38220090	24,500.00
CLS2395HU	Human Cyclin-dependent kinase 1,CDK-1 ELISA Kit	96 Test	38220090	24,500.00
CLS2396HU	Human Ribonuclease,RNASE ELISA Kit	96 Test	38220090	24,500.00
CLS2397HU	Human Poly ADP ribose polymerase,PARP ELISA Kit	96 Test	38220090	24,500.00
CLS2398HU	Human Cyclin Dependent Kinase 5,CDK5 ELISA Kit	96 Test	38220090	24,500.00
CLS2399HU	Human Kallikrein 11,KLK11 ELISA Kit	96 Test	38220090	24,500.00
CLS2400HU	Human Kallikrein 10,KLK10 ELISA Kit	96 Test	38220090	24,500.00
CLS2401HU	Human Phospholipase Cy1,PLCy1 ELISA Kit	96 Test	38220090	24,500.00
CLS2402HU	Human Sialidase-1,NEU1 ELISA Kit	96 Test	38220090	24,500.00
CLS2403HU	Human urease related protein C,UreC ELISA Kit	96 Test	38220090	24,500.00
CLS2404HU	Human phosphoinositide-specific phospholipase C,PIPLC ELISA Kit	96 Test	38220090	24,500.00
CLS2405HU	Human tyrosine kinase2,Tyk-2 ELISA Kit	96 Test	38220090	24,500.00
CLS2406HU	Human adaptor molecule apoptotic peptidase activating factor 1,APAF1 ELISA Kit	96 Test	38220090	24,500.00
CLS2407HU	Human integrin-linked kinase 1,ILK-1 ELISA Kit	96 Test	38220090	24,500.00
CLS2408HU	Human terminal deoxynucleotidyl transferase,TdT ELISA Kit	96 Test	38220090	24,500.00
CLS2409HU	Human serine/threonine protein kinase,STK ELISA Kit	96 Test	38220090	24,500.00
CLS2410HU	Human interleukin receptor associated kinase,IRAK ELISA Kit	96 Test	38220090	24,500.00
CLS2411HU	Human urokinase,UK ELISA Kit	96 Test	38220090	24,500.00
CLS2412HU	Human Protein disulfide-isomerase precursor,PDI ELISA Kit	96 Test	38220090	24,500.00
CLS2413HU	Human Protein Phosphatase,PP ELISA Kit	96 Test	38220090	24,500.00
CLS2414HU	Human leukocyte exastase,HLE ELISA Kit	96 Test	38220090	24,500.00
CLS2415HU	Human Angiotensinase A,ATA ELISA Kit	96 Test	38220090	24,500.00
CLS2416HU	Human phospho Protein Kinase C,P-PKC ELISA Kit	96 Test	38220090	24,500.00
CLS2417HU	human Rho family GTPase 1,RND1 ELISA Kit	96 Test	38220090	24,500.00
CLS2418HU	human uridine phosphorylase 1,UPP1 ELISA Kit	96 Test	38220090	24,500.00
CLS2419HU	Human alcohol dehydrogenase,ADH ELISA Kit	96 Test	38220090	24,500.00
CLS2420HU	Human dopamine-β-hydroxylase,DBH ELISA Kit	96 Test	38220090	24,500.00
CLS2421HU	Human choline acetylase,CHAc ELISA Kit	96 Test	38220090	24,500.00
CLS2422HU	Human isocitrate dehydrogenase,ICD ELISA Kit	96 Test	38220090	24,500.00

Cat.No.	Product Description	Pack Size	HSN	Unit Price
CLS2423HU	Human α mannosidase, α Manase ELISA Kit	96 Test	38220090	24,500.00
CLS2424HU	Human L-Phenylalanine amonla-lyase,PAL ELISA Kit	96 Test	38220090	24,500.00
CLS2425HU	Human nicotinamide adenine dinucleotide phosphate/ II ,NADPH/Co II/TPN ELISA Kit	96 Test	38220090	24,500.00
CLS2426HU	Human 1,3- β D glucosidase,1,3- β D-Glu ELISA Kit	96 Test	38220090	24,500.00
CLS2427HU	Human macrocreatine kinase,macro-CK ELISA Kit	96 Test	38220090	24,500.00
CLS2428HU	Human targeted ribonuclease, TR ELISA Kit	96 Test	38220090	24,500.00
CLS2429HU	Human protein kinase C,PKC ELISA Kit	96 Test	38220090	24,500.00
CLS2430HU	Human Aldolase,ALD ELISA Kit	96 Test	38220090	24,500.00
CLS2431HU	Human adenyl cyclase 1,AC-1 ELISA Kit	96 Test	38220090	24,500.00
CLS2432HU	Human Soluble Adenylate Cyclase,sAC ELISA Kit	96 Test	38220090	24,500.00
CLS2433HU	Human protein tyrosine kinase,PTK ELISA Kit	96 Test	38220090	24,500.00
CLS2434HU	Human protein tyrosine phosphatase,PTP/PTPase ELISA Kit	96 Test	38220090	24,500.00
CLS2435HU	Human procollagen C peptidase,PCP ELISA Kit	96 Test	38220090	24,500.00
CLS2436HU	Human urokinase-type plasminogen activator,uPA/PLAU ELISA Kit	96 Test	38220090	24,500.00
CLS2437HU	Human β -Lactamase inhibitors,BLI ELISA Kit	96 Test	38220090	24,500.00
CLS2438HU	Human β -lactamase ELISA Kit	96 Test	38220090	24,500.00
CLS2439HU	Human β mannosidase, β Manase ELISA Kit	96 Test	38220090	24,500.00
CLS2440HU	Human cathepsin D,cath-D ELISA Kit	96 Test	38220090	24,500.00
CLS2441HU	Human aconitase 2,ACO-2 ELISA Kit	96 Test	38220090	24,500.00
CLS2442HU	Human 26S proteasome,26S PSM ELISA Kit	96 Test	38220090	24,500.00
CLS2443HU	Human Cyclin-dependent kinase 4,CDK-4 ELISA Kit	96 Test	38220090	24,500.00
CLS2444HU	Human Placental alkaline pkosphatase,PLAP ELISA Kit	96 Test	38220090	24,500.00
CLS2445HU	Human receptor tyrosine kinase,RTKs ELISA Kit	96 Test	38220090	24,500.00
CLS2446HU	Human A Disintegrin And Metalloprotease 8,ADAM8 ELISA Kit	96 Test	38220090	24,500.00
CLS2447HU	Human protein disulfide isomerase,PDI ELISA Kit	96 Test	38220090	24,500.00
CLS2448HU	Human dopamine decarboxylase,DDC ELISA Kit	96 Test	38220090	24,500.00
CLS2449HU	Human glucose-6-phosphate isomerase,GPI ELISA Kit	96 Test	38220090	24,500.00
CLS2450HU	Human Hexokinase,HK ELISA Kit	96 Test	38220090	24,500.00
CLS2451HU	Human pyruvate dehydrogenase-E1,PDH E1 ELISA Kit	96 Test	38220090	24,500.00
CLS2452HU	Human protein kinase B,PKB ELISA Kit	96 Test	38220090	24,500.00
CLS2453HU	Human Pyruvate kinase isozymes M1/M2,M2-PK ELISA Kit	96 Test	38220090	24,500.00
CLS2454HU	Human Thyroid-Peroxidase,TPO ELISA Kit	96 Test	38220090	24,500.00
CLS2455HU	Human Prostatic Acid Phosphatase,PAP ELISA Kit	96 Test	38220090	24,500.00
CLS2456HU	Human Prostaglandin D Synthase,PGDS ELISA Kit	96 Test	38220090	24,500.00
CLS2457HU	Human granzymes A,Gzms-A ELISA Kit	96 Test	38220090	24,500.00
CLS2458HU	Human FMS-like tyrosine kinase 3 ligand,Flt-3L ELISA Kit	96 Test	38220090	24,500.00
CLS2459HU	Human Histone Deacetylase,HD ELISA Kit	96 Test	38220090	24,500.00
CLS2460HU	Human Phosphatidylinositol N- acetylglucosaminyltransferase subunit Y,PIGY ELISA Kit	96 Test	38220090	24,500.00
CLS2461HU	Human caspase activated deoxyribonuclease,CAD ELISA Kit	96 Test	38220090	24,500.00
CLS2462HU	Human Methylase ELISA Kit	96 Test	38220090	24,500.00
CLS2463HU	Human Peptidyl prolyl cis/trans isomerase,PPI ELISA Kit	96 Test	38220090	24,500.00
CLS2464HU	Human myosin light chain kinase,MLCK ELISA Kit	96 Test	38220090	24,500.00
CLS2465HU	Human anapastic lymphoma kinase,ALK ELISA Kit	96 Test	38220090	24,500.00
CLS2466HU	Human neutrophilic alkaline phosphatase,NAP ELISA Kit	96 Test	38220090	24,500.00
CLS2467HU	Human 12-lipoxygenase,LOX-12 ELISA Kit	96 Test	38220090	24,500.00
CLS2468HU	Human Cyclin-dependent kinase 7,CDK-7 ELISA Kit	96 Test	38220090	24,500.00
CLS2469HU	Human Cyclin-dependent kinase 2,CDK-2 ELISA Kit	96 Test	38220090	24,500.00
CLS2470HU	human eosinophil-associated ribonuclease A family member 12,EAR12 ELISA KIT	96 Test	38220090	24,500.00
CLS2471HU	Human A Disintegrin And Metalloprotease 9,ADAM9 ELISA Kit	96 Test	38220090	24,500.00
CLS2472HU	human phospholipid scramblase 1,PLSCR1 ELISA KIT	96 Test	38220090	24,500.00

Cat.No.	Product Description	Pack Size	HSN	Unit Price
CLS2473HU	human aldehyde dehydrogenase 18 family member A1,ALDH18A1 ELISA Kit	96 Test	38220090	24,500.00
CLS2474HU	human transglutaminase 2C polypeptide,TGM2 ELISA Ki	96 Test	38220090	24,500.00
CLS2475HU	Human aldehyde dehydrogenase,ALDH ELISA Kit	96 Test	38220090	24,500.00
CLS2476HU	Human α -enolase, α ENOL ELISA Kit	96 Test	38220090	24,500.00
CLS2477HU	Human Acid Phosphatase 1,ACP1 ELISA Kit	96 Test	38220090	24,500.00
CLS2478HU	Human Phosphoglucosmutase,PGM ELISA Kit	96 Test	38220090	24,500.00
CLS2479HU	Humany-glutamyl systeine synthetase, γ -ECS ELISA Kit	96 Test	38220090	24,500.00
CLS2480HU	Human DNA-dependent protein kinase catalytic subunit,PRKDC ELISA Kit	96 Test	38220090	24,500.00
CLS2481HU	Human Noradrenaline Bitartas,NE-B ELISA Kit	96 Test	38220090	24,500.00
CLS2482HU	Human Prostaglandin F,PG-F ELISA Kit	96 Test	38220090	24,500.00
CLS2483HU	Human Histone deacetylase 8,HDAC8 ELISA KIT	96 Test	38220090	24,500.00
CLS2484HU	Human 6-keto-prostaglandin F2a,6-K-PGF2a ELISA Kit	96 Test	38220090	24,500.00
CLS2485HU	Human androgen receptor,AR ELISA Kit	96 Test	38220090	24,500.00
CLS2486HU	Human placetal lactogen,PL ELISA Kit	96 Test	38220090	24,500.00
CLS2487HU	Human Immunoreactive growth hormone,irGH ELISA Kit	96 Test	38220090	24,500.00
CLS2488HU	Human secretin receptor,SR ELISA Kit	96 Test	38220090	24,500.00
CLS2489HU	Human Androstenedione,ASD ELISA Kit	96 Test	38220090	24,500.00
CLS2490HU	Human Growth Hormone Releasing Peptide,GHRP ELISA Kit	96 Test	38220090	24,500.00
CLS2491HU	Human Estradiol receptor,ER ELISA Kit	96 Test	38220090	24,500.00
CLS2492HU	Human adrenergic alpha-1A receptor,ADRA1A ELISA Kit	96 Test	38220090	24,500.00
CLS2493HU	Human Dehydroepiandrosterone S7,DHEA-S7 ELISA Kit	96 Test	38220090	24,500.00
CLS2494HU	Human Isoprenaline Hydrochloride,iso-Hyd ELISA Kit	96 Test	38220090	24,500.00
CLS2495HU	Human glucocorticoid receptor- α ,GR- α ELISA Kit	96 Test	38220090	24,500.00
CLS2496HU	Human glucocorticoid receptor- β ,GR- β ELISA Kit	96 Test	38220090	24,500.00
CLS2497HU	Human Long acting thyroid stimulator,LATS ELISA Kit	96 Test	38220090	24,500.00
CLS2498HU	Human Chorionic Gonadotrophin β , β -CG ELISA Kit	96 Test	38220090	24,500.00
CLS2499HU	Human Free Testosterone,F-TESTO ELISA Kit	96 Test	38220090	24,500.00
CLS2500HU	Human Ultrasensitivity Thyroxine,u-T4 ELISA Kit	96 Test	38220090	24,500.00
CLS2501HU	Human Chlamydia pneumoniae IgM,Cpn IgM ELISA Kit	96 Test	38220090	24,500.00
CLS2502HU	Human Aquaporin 5,AQP-5 ELISA Kit	96 Test	38220090	24,500.00
CLS2503HU	Human Protein tyrosine phosphatase receptor type A,PTPRA ELISA Kit	96 Test	38220090	24,500.00
CLS2504HU	Human Lung resistance-related protein,LRP ELISA Kit	96 Test	38220090	24,500.00
CLS2505HU	Human Chlamydia pneumoniae antibody,Cpn Ab ELISA Kit	96 Test	38220090	24,500.00
CLS2506HU	Human filamentous hemagglutinin,FHA ELISA Kit	96 Test	38220090	24,500.00
CLS2507HU	Human Glutamate [NMDA] receptor subunit zeta-1,GRIN1 ELISA Kit	96 Test	38220090	24,500.00
CLS2508HU	Human Mycoplasma pneumoniae antibody,MP-Ab ELISA Kit	96 Test	38220090	24,500.00
CLS2509HU	Human α 2 macroglobulin precursor,pre- α 2 MG ELISA Kit	96 Test	38220090	24,500.00
CLS2510HU	Human Retina-specific copper amine oxidase,AOC2 ELISA Kit	96 Test	38220090	24,500.00
CLS2511HU	Human Proteinuria,UP ELISA Kit	96 Test	38220090	24,500.00
CLS2512HU	Human bacterial vaginosis,BV ELISA Kit	96 Test	38220090	24,500.00
CLS2513HU	Human Semaphorin 6A (SEMA6A)ELISA Kit	96 Test	38220090	24,500.00
CLS2514HU	Human α 1-microglobulin, α 1-MG ELISA Kit	96 Test	38220090	24,500.00
CLS2515HU	Human Ureaplasma urealyticum antibody,UU-Ab ELISA Kit	96 Test	38220090	24,500.00
CLS2516HU	Human Nandrolone Phenylpropionate,NP ELISA Kit	96 Test	38220090	24,500.00
CLS2517HU	Human ATP-sensitive inward rectifier potassium channel 8,KCNJ8/Kir6.1 ELISA Kit	96 Test	38220090	24,500.00
CLS2518HU	Human G protein-activated inward rectifier potassium channel 3,KCNJ9/GIRK3 ELISA Kit	96 Test	38220090	24,500.00
CLS2519HU	Human Deoxyribonuclease-2-alpha,DNASE2A ELISA Kit	96 Test	38220090	24,500.00
CLS2520HU	Human platelet membrane glycoprotein IIbIIIa,GP-IIbIIIa ELISA Kit	96 Test	38220090	24,500.00

Cat.No.	Product Description	Pack Size	HSN	Unit Price
CLS2521HU	Human alpha-granular membrane protein,GMP-140 ELISA Kit	96 Test	38220090	24,500.00
CLS2522HU	Human coagulation factor VIII related antigen,FVIII-Ag ELISA Kit	96 Test	38220090	24,500.00
CLS2523HU	Human Factor VIII-related Antigen,FVIII Ag ELISA Kit	96 Test	38220090	24,500.00
CLS2524HU	Human low molecular weight heparin,LMWH ELISA Kit	96 Test	38220090	24,500.00
CLS2525HU	Human activated protein C resistance,APCR ELISA Kit	96 Test	38220090	24,500.00
CLS2526HU	Human 2,3-dinor thromboxane B2,2,3-dinor-TXB2 ELISA Kit	96 Test	38220090	24,500.00
CLS2527HU	Human platelet basic protein,PBP ELISA Kit	96 Test	38220090	24,500.00
CLS2528HU	Human plasmin/fibrinolysin,PL/Fbn ELISA Kit	96 Test	38220090	24,500.00
CLS2529HU	Human apotransferrin,apoTf ELISA Kit	96 Test	38220090	24,500.00
CLS2530HU	Human coagulation factor VII,FVII ELISA Kit	96 Test	38220090	24,500.00
CLS2531HU	Human Plasma fibronectin,pFN ELISA kit	96 Test	38220090	24,500.00
CLS2532HU	Human platelet membrane glycoprotein IV,GP-IV ELISA Kit	96 Test	38220090	24,500.00
CLS2533HU	Human plasma anticoagulant protein S,PS ELISA Kit	96 Test	38220090	24,500.00
CLS2534HU	Human plasma anticoagulant protein C,PC ELISA Kit	96 Test	38220090	24,500.00
CLS2535HU	Human coagulation factor XII,FXII ELISA Kit	96 Test	38220090	24,500.00
CLS2536HU	Human coagulation factor III,FIII ELISA Kit	96 Test	38220090	24,500.00
CLS2537HU	Human Kremen protein 1(KREMEN1) ELISA Kit	96 Test	38220090	24,500.00
CLS2538HU	Human erythrocyte membrane protein,EMP ELISA Kit	96 Test	38220090	24,500.00
CLS2539HU	Human carboxyhemoglobin,HbCO ELISA Kit	96 Test	38220090	24,500.00
CLS2540HU	Human soluble fibrin monomer complex,SFMC ELISA Kit	96 Test	38220090	24,500.00
CLS2541HU	Human free haemoglobin,f-Hb ELISA Kit	96 Test	38220090	24,500.00
CLS2542HU	Human Vitamin K-dependent protein S,VKDPs ELISA kit	96 Test	38220090	24,500.00
CLS2543HU	Human coagulation factor Xa,FXa ELISA kit	96 Test	38220090	24,500.00
CLS2544HU	Human Poly Serium Antigen,PHSA ELISA Kit	96 Test	38220090	24,500.00
CLS2545HU	Human Free Protein S,FP-S ELISA Kit	96 Test	38220090	24,500.00
CLS2546HU	Human Haptoglobin precursor,pre-Hpt/HAP ELISA KIT	96 Test	38220090	24,500.00
CLS2547HU	Human Hemoglobin H,HbH ELISA Kit	96 Test	38220090	24,500.00
CLS2548HU	Human Hemoglobin C,HbC ELISA Kit	96 Test	38220090	24,500.00
CLS2549HU	Human Fibrinogen like peptide 2,fgl2 ELISA Kit	96 Test	38220090	24,500.00
CLS2550HU	Human coagulation factor X ,F X ELISA Kit	96 Test	38220090	24,500.00
CLS2551HU	Human Stonin 2 (STON2)ELISA Kit	96 Test	38220090	24,500.00
CLS2552HU	Human β -Thromboglobulin, β -TG ELISA Kit	96 Test	38220090	24,500.00
CLS2553HU	Human retinal soluble antigen,Sag ELISA Kit	96 Test	38220090	24,500.00
CLS2554HU	Human retinoic acid inducible gene/RIG-like receptor,RLR-9 ELISA Kit	96 Test	38220090	24,500.00
CLS2555HU	Human crystal proteins α ,Cry α ELISA Kit	96 Test	38220090	24,500.00
CLS2556HU	Human crystal proteins β ,Cry β ELISA Kit	96 Test	38220090	24,500.00
CLS2557HU	Human gelson ELISA Kit	96 Test	38220090	24,500.00
CLS2558HU	Human retinoblastoma tumor suppressor protein,pRB ELISA Kit	96 Test	38220090	24,500.00
CLS2559HU	Human Opacity-associated proteins,OPAs ELISA Kit	96 Test	38220090	24,500.00
CLS2560HU	Human eye muscle antibody,EMAb ELISA Kit	96 Test	38220090	24,500.00
CLS2561HU	Human hemoglobin-advanced glycosylation end products,Hb-AGE ELISA Kit	96 Test	38220090	24,500.00
CLS2562HU	Human α -sarcomeric actin, α -SCA ELISA Kit	96 Test	38220090	24,500.00
CLS2563HU	Human Hirudin,HRD ELISA Kit	96 Test	38220090	24,500.00
CLS2564HU	Human Ataxia telangiectasia mutated,ATM ELISA Kit	96 Test	38220090	24,500.00
CLS2565HU	Human α -Actinin 3,ACTN-3 ELISA Kit	96 Test	38220090	24,500.00
CLS2566HU	Human β amyloid precursor protein, β APP ELISA Kit	96 Test	38220090	24,500.00
CLS2567HU	Human tyrosine kinase with immunoglobulin-like and EGF-like domains 1,Tie1 ELISA kit	96 Test	38220090	24,500.00
CLS2568HU	Human Myosin,MYS ELISA Kit	96 Test	38220090	24,500.00
CLS2569HU	Human 6-keto-prostaglandin,6-K-PG ELISA Kit	96 Test	38220090	24,500.00
CLS2570HU	Human Big Endothelin,Big ET ELISA Kit	96 Test	38220090	24,500.00
CLS2571HU	Human vasopeptidase inhibitors,VPI ELISA Kit	96 Test	38220090	24,500.00

Cat.No.	Product Description	Pack Size	HSN	Unit Price
CLS2572HU	Human 8-epi-prostaglandin F2alpha,8-epi-PGF2α ELISA Kit	96 Test	38220090	24,500.00
CLS2573HU	Human phospholamban,PLN ELISA Kit	96 Test	38220090	24,500.00
CLS2574HU	human serum amyloid A3,SAA3 ELISA Kit	96 Test	38220090	24,500.00
CLS2575HU	human angiotensin II receptor type I a,Agtr I a ELISA Kit	96 Test	38220090	24,500.00
CLS2576HU	Human Alpha-Actin,α Actin ELISA Kit	96 Test	38220090	24,500.00
CLS2577HU	Human cardiac ankyrin repeat domain 1,ANKRD1 ELISA Kit	96 Test	38220090	24,500.00
CLS2578HU	Human Angiotensin II Receptor 2,AT2R ELISA Kit	96 Test	38220090	24,500.00
CLS2579HU	Human LDL-IC ELISA Kit	96 Test	38220090	24,500.00
CLS2580HU	Human dopamine D2 receptor,D2R ELISA Kit	96 Test	38220090	24,500.00
CLS2581HU	Human α-Endomorphin,α-EP ELISA Kit	96 Test	38220090	24,500.00
CLS2582HU	Human Beta-Endorphin receptor,β-EPR ELISA Kit	96 Test	38220090	24,500.00
CLS2583HU	Human endomorphin-2,EM-2 ELISA Kit	96 Test	38220090	24,500.00
CLS2584HU	Human neuronal apoptosis inhibitory protein,NAIP ELISA Kit	96 Test	38220090	24,500.00
CLS2585HU	Human Aquaporin 0,AQP-0 ELISA Kit	96 Test	38220090	24,500.00
CLS2586HU	Human Peptide γ,Py ELISA Kit	96 Test	38220090	24,500.00
CLS2587HU	Human Netrin-4,Ntn4 ELISA Kit	96 Test	38220090	24,500.00
CLS2588HU	Human muscarinic acetylcholine receptor M3,M-AChR M3 ELISA Kit	96 Test	38220090	24,500.00
CLS2589HU	Human muscarinic acetylcholine receptor,M-AChR ELISA Kit	96 Test	38220090	24,500.00
CLS2590HU	Human 6-hydroxydopamine,6-OHDA ELISA Kit	96 Test	38220090	24,500.00
CLS2591HU	Human cadherin-related neuronal receptor1,CNR-1 ELISA Kit	96 Test	38220090	24,500.00
CLS2592HU	Human delta sleep-inducing peptide,DSIP ELISA Kit	96 Test	38220090	24,500.00
CLS2593HU	Human voltage-gated calcium channel,VGCC ELISA Kit	96 Test	38220090	24,500.00
CLS2594HU	Human microtubule-associated protein 2,MAP-2 ELISA Kit	96 Test	38220090	24,500.00
CLS2595HU	Human Neuroglobin,NGB ELISA Kit	96 Test	38220090	24,500.00
CLS2596HU	Human brain-gut peptides,BGP/Ghrelin Elisa kit	96 Test	38220090	24,500.00
CLS2597HU	Human enkephalin,ENK ELISA Kit	96 Test	38220090	24,500.00
CLS2598HU	Human anti-Nogo-A antibody,NOGO-A Ab ELISA Kit	96 Test	38220090	24,500.00
CLS2599HU	Human dynorphin,Dyn ELISA Kit	96 Test	38220090	24,500.00
CLS2600HU	Human kaliuretic peptide,KP ELISA Kit	96 Test	38220090	24,500.00
CLS2601HU	Human Semaphorin 6B (SEMA6B)ELISA Kit	96 Test	38220090	24,500.00
CLS2602HU	Human myelin protein 2,p2 ELISA Kit	96 Test	38220090	24,500.00
CLS2603HU	Human atrial natriuretic factor,ANF ELISA Kit	96 Test	38220090	24,500.00
CLS2604HU	Human nicotinic acetylcholine Transferase receptor,N-AChTR ELISA Kit	96 Test	38220090	24,500.00
CLS2605HU	Human Parkinson disease 2/parkin,Park2 ELISA Kit	96 Test	38220090	24,500.00
CLS2606HU	Human Helicobacter pylori IgG ,Hp-IgG ELISA Kit	96 Test	38220090	24,500.00
CLS2607HU	Human hepatic lipase,HL ELISA Kit	96 Test	38220090	24,500.00
CLS2608HU	Human fibronectin related antigen,FRA ELISA Kit	96 Test	38220090	24,500.00
CLS2609HU	Human gastrin cell antibody,GCA ELISA Kit	96 Test	38220090	24,500.00
CLS2610HU	Human Helicobacter pylori-Hsp60,HP-HSP60 ELISA kit	96 Test	38220090	24,500.00
CLS2611HU	Human Intestinal trefoil factor,ITF ELISA Kit	96 Test	38220090	24,500.00
CLS2612HU	Human Type II Procollagen,PCII ELISA Kit	96 Test	38220090	24,500.00
CLS2613HU	Human Deoxyribonuclease-2-beta,DNASE2B ELISA Kit	96 Test	38220090	24,500.00
CLS2614HU	human Pepsinogen C,PG-C ELISA Kit	96 Test	38220090	24,500.00
CLS2615HU	Human HyaJuronate binding protein,HABP ELISA Kit	96 Test	38220090	24,500.00
CLS2616HU	Human Helicobacter pylori IgM,Hp-IgM ELISA Kit	96 Test	38220090	24,500.00
CLS2617HU	Human gastrin-releasing peptide,GRP ELISA Kit	96 Test	38220090	24,500.00
CLS2618HU	Human Collagen-like Bioprotein II ,HCBII ELISA Kit	96 Test	38220090	24,500.00
CLS2619HU	Human Cytotoxin-associated protein,CagA ELISA Kit	96 Test	38220090	24,500.00
CLS2620HU	Human gastrin receptor,GsaR ELISA Kit	96 Test	38220090	24,500.00
CLS2621HU	Human DNA repair protein RAD51 homolog 1(RAD51) ELISA Kit	96 Test	38220090	24,500.00

Cat.No.	Product Description	Pack Size	HSN	Unit Price
CLS2622HU	Human Anti-keratin antibody,AKA ELISA Kit	96 Test	38220090	24,500.00
CLS2623HU	human serum deprivation response,SDPR ELISA Kit	96 Test	38220090	24,500.00
CLS2624HU	Human soluble Liver X Receptor,LXR ELISA Kit	96 Test	38220090	24,500.00
CLS2625HU	Human soluble Retinoid X Receptor,RXR ELISA Kit	96 Test	38220090	24,500.00
CLS2626HU	Human soluble Farnesoid X Receptor,FXR ELISA Kit	96 Test	38220090	24,500.00
CLS2627HU	Human Peroxisome Proliferator Activated Receptor beta,PPAR-β ELISA Kit	96 Test	38220090	24,500.00
CLS2628HU	Human Apolipoprotein A1 precursor,Pre-Apo-A1 ELISA kit	96 Test	38220090	24,500.00
CLS2629HU	human guanylate nucleotide binding protein 4,Gbp4 ELISA Kit	96 Test	38220090	24,500.00
CLS2630HU	human cytochrome b561,cytb561 ELISA Kit	96 Test	38220090	24,500.00
CLS2631HU	Human Urocortin,UCN ELISA Kit	96 Test	38220090	24,500.00
CLS2632HU	Human selenoprotein 1,SEP1 ELISA Kit	96 Test	38220090	24,500.00
CLS2633HU	Human electron-transfer-flavoprotein beta polypeptide,ETFB ELISA Kit	96 Test	38220090	24,500.00
CLS2634HU	Human tenascin,TN ELISA Kit	96 Test	38220090	24,500.00
CLS2635HU	Human Lipoxin A4 receptor-like protein,LRLP ELISA Kit	96 Test	38220090	24,500.00
CLS2636HU	Human phosphatidylserine,PS ELISA Kit	96 Test	38220090	24,500.00
CLS2637HU	Human choline phosphoglyceride,PC/CPG ELISA Kit	96 Test	38220090	24,500.00
CLS2638HU	Human calumenin,CALU ELISA Kit	96 Test	38220090	24,500.00
CLS2639HU	Human dermato-pontin,DPT ELISA Kit	96 Test	38220090	24,500.00
CLS2640HU	Human hydroxylysine,Hyl ELISA Kit	96 Test	38220090	24,500.00
CLS2641HU	Human glycoposphatidylinositol,GPI ELISA Kit	96 Test	38220090	24,500.00
CLS2642HU	Human deoxyuridinetriphate,DUTP ELISA Kit	96 Test	38220090	24,500.00
CLS2643HU	Human CpG oligodeoxynucleotide,CpG-ODN ELISA Kit	96 Test	38220090	24,500.00
CLS2644HU	Human fibromodulin,FMOD ELISA Kit	96 Test	38220090	24,500.00
CLS2645HU	Human Osteogenic Growth Peptide,OGP ELISA Kit	96 Test	38220090	24,500.00
CLS2646HU	Human Hydroxy-Pyridinium crosslinks,OH-PYD ELISA Kit	96 Test	38220090	24,500.00
CLS2647HU	Human Translocator Protein (TSPO)ELISA Kit	96 Test	38220090	24,500.00
CLS2648HU	Human Free erythrocyte protoporphyrin,FEP ELISA Kit	96 Test	38220090	24,500.00
CLS2649HU	Human α-galactosyle,α-Gal ELISA Kit	96 Test	38220090	24,500.00
CLS2650HU	Human 17-ketosteroids,17-KS ELISA Kit	96 Test	38220090	24,500.00
CLS2651HU	Human Adenylate Cyclase 4, Brain (ADCY4)ELISA Kit	96 Test	38220090	24,500.00
CLS2652HU	Human bone morphogenetic proteins,BMPs ELISA Kit	96 Test	38220090	24,500.00
CLS2653HU	Human glucokinase regulatory protein,GKRP ELISA Kit	96 Test	38220090	24,500.00
CLS2654HU	Human tenascin-R,TN-R ELISA Kit	96 Test	38220090	24,500.00
CLS2655HU	Human Caldesmon,CALD ELISA Kit	96 Test	38220090	24,500.00
CLS2656HU	Human calcineurin,CaN ELISA Kit	96 Test	38220090	24,500.00
CLS2657HU	Human Calretinin,CR ELISA Kit	96 Test	38220090	24,500.00
CLS2658HU	Human GRB10-interacting GYF protein 1,GIGYF1 ELISA Kit	96 Test	38220090	24,500.00
CLS2659HU	Human elongin A,EloA ELISA Kit	96 Test	38220090	24,500.00
CLS2660HU	Human Acylation Stimulating Protein,ASP ELISA Kit	96 Test	38220090	24,500.00
CLS2661HU	Human Histone deacetylase complex subunit SAP30L(SAP30L) ELISA KIT	96 Test	38220090	24,500.00
CLS2662HU	Human 1,3-Disphosphoglycerate,1,3-DPG ELISA Kit	96 Test	38220090	24,500.00
CLS2663HU	Human low-density lipoprotein-receptor-related protein,LRP-6 ELISA Kit	96 Test	38220090	24,500.00
CLS2664HU	Human very low density lipoprotein receptor,VLDLR ELISA Kit	96 Test	38220090	24,500.00
CLS2665HU	Human low density lipoprotein receptor,LDLR ELISA Kit	96 Test	38220090	24,500.00
CLS2666HU	Human 15-lipoxygenase,15-LO/LOX ELISA Kit	96 Test	38220090	24,500.00
CLS2667HU	Human Glycogen phosphorylase II,GP-II ELISA Kit	96 Test	38220090	24,500.00
CLS2668HU	Human Glycogen phosphorylase MM,GP-MM ELISA Kit	96 Test	38220090	24,500.00
CLS2669HU	Human Glycogen phosphorylase BB,GP-BB ELISA Kit	96 Test	38220090	24,500.00
CLS2670HU	Human Crosslaps,Cr ELISA Kit	96 Test	38220090	24,500.00
CLS2671HU	Human pyridinium crosslink/PyriLinks,PY ELISA Kit	96 Test	38220090	24,500.00
CLS2672HU	Human skeletal muscle Actinin-α,sm Actinin-α ELISA Kit	96 Test	38220090	24,500.00

Cat.No.	Product Description	Pack Size	HSN	Unit Price
CLS2673HU	Human Semaphorin 4C (SEMA4C)ELISA Kit	96 Test	38220090	24,500.00
CLS2674HU	Human leukotriene E4,LT-E4 ELISA Kit	96 Test	38220090	24,500.00
CLS2675HU	Human histon-H2b ELISA Kit	96 Test	38220090	24,500.00
CLS2676HU	Human Semaphorin 3E (SEMA3E)ELISA Kit	96 Test	38220090	24,500.00
CLS2677HU	Human Bone morphogenetic protein receptor II ,BMPR-II ELISA Kit	96 Test	38220090	24,500.00
CLS2678HU	Human Bone morphogenetic protein receptor 1A,BMPR-1A ELISA Kit	96 Test	38220090	24,500.00
CLS2679HU	Human Semaphorin 4F (SEMA4F)ELISA Kit	96 Test	38220090	24,500.00
CLS2680HU	Human G protein-regulated inducer of neurite outgrowth 1,GPRIN1 ELISA Kit	96 Test	38220090	24,500.00
CLS2681HU	Human Protein Tyrosine Phosphatase Receptor Type T,PTPRT/LAR ELISA Kit	96 Test	38220090	24,500.00
CLS2682HU	Human Protein Tyrosine Phosphatase Receptor Type H(PTPRH)ELISA Kit	96 Test	38220090	24,500.00
CLS2683HU	Human Excision Repair Cross Complement 2,ERCC2 ELISA Kit	96 Test	38220090	24,500.00
CLS2684HU	Human cytokeratin 13,CK-13 ELISA Kit	96 Test	38220090	24,500.00
CLS2685HU	human β -tubulin,TUBB ELISA kit	96 Test	38220090	24,500.00
CLS2686HU	human ras homolog gene family,memmber B,RHOB ELISA Kit	96 Test	38220090	24,500.00
CLS2687HU	Human small breast epithelial mucin,SBEM ELISA Kit	96 Test	38220090	24,500.00
CLS2688HU	human MAX dimerization protein 1,mdx1 ELISA Kit	96 Test	38220090	24,500.00
CLS2689HU	Human Argrophilic nucleolar organizer region proteins,Ag-NORs ELISA Kit	96 Test	38220090	24,500.00
CLS2690HU	human ubiquitin D,UBD ELISA Kit	96 Test	38220090	24,500.00
CLS2691HU	Human common acute lymphocytic leukaemia antigen,CALLA ELISA Kit	96 Test	38220090	24,500.00
CLS2692HU	Human epidermal keratin,EK ELISA Kit	96 Test	38220090	24,500.00
CLS2693HU	Human Immune ribonucleic acid/immune RNA,iRNA ELISA Kit	96 Test	38220090	24,500.00
CLS2694HU	Human Oncogene Protein p190/bcr-abl ELISA Kit	96 Test	38220090	24,500.00
CLS2695HU	Human recombination activating gene 2,RAG-2 ELISA Kit	96 Test	38220090	24,500.00
CLS2696HU	Human growth-regulated oncogene β /melanoma growth stimulating activity,GRO β /MGSA ELISA Kit	96 Test	38220090	24,500.00
CLS2697HU	Human melanoma derived leucine zipper extra-nuclear factor,MLZE ELISA Kit	96 Test	38220090	24,500.00
CLS2698HU	Human latent membrane protein-1,LMP-1 ELISA Kit	96 Test	38220090	24,500.00
CLS2699HU	Human growth-regulated oncogeney/melanoma growth stimulating activity,GRO γ /MGSA ELISA Kit	96 Test	38220090	24,500.00
CLS2700HU	Human thymus-leukemia antigen,TLa ELISA Kit	96 Test	38220090	24,500.00
CLS2701HU	humna v-rel avian reticuloendotheliosis viral oncogene related B,RELB ELISA Kit	96 Test	38220090	24,500.00
CLS2702HU	human major vault protein,MVP ELISA Kit	96 Test	38220090	24,500.00
CLS2703HU	Human Epithelial membrane antigen,EMA ELISA Kit	96 Test	38220090	24,500.00
CLS2704HU	Human Tumor Specific Growth Facter/tumor supplied group of factor,TSGF ELISA Kit	96 Test	38220090	24,500.00
CLS2705HU	human lung cancer Marker ELISA Kit	96 Test	38220090	24,500.00
CLS2706HU	human gastric carcinoma Marker ELISA Kit	96 Test	38220090	24,500.00
CLS2707HU	Human Gastrointestinalcancer Marker-CA199 ELISA Kit	96 Test	38220090	24,500.00
CLS2708HU	Human mammary carcinoma Marker-CA153 ELISA Kit	96 Test	38220090	24,500.00
CLS2709HU	human lectin-galactose binding-soluble 3,Lgals3 ELISA Kit	96 Test	38220090	24,500.00
CLS2710HU	Human high mobility group protein 17,HMG-17 ELISA Kit	96 Test	38220090	24,500.00
CLS2711HU	Human primary hepatic carcinoma,PHC ELISA Kit	96 Test	38220090	24,500.00
CLS2712HU	Human cytokeratin Low Molecular Weight,CK-LMW ELISA Kit	96 Test	38220090	24,500.00
CLS2713HU	Human fetal sulfoslycoprotein antigen,FSA ELISA Kit	96 Test	38220090	24,500.00
CLS2714HU	Human tumor marker DR-70 for lung cancer,DR-70TM ELISA Kit	96 Test	38220090	24,500.00
CLS2715HU	Human epithelial specific antigen,ESA ELISA Kit	96 Test	38220090	24,500.00

Cat.No.	Product Description	Pack Size	HSN	Unit Price
CLS2716HU	Human recombination activating gene 1,RAG-1 ELISA Kit	96 Test	38220090	24,500.00
CLS2717HU	Human tumor specific transplantation antigen,TSTA ELISA Kit	96 Test	38220090	24,500.00
CLS2718HU	Human B-cell leukemia/lymphoma 3,Bcl3 ELISA Kit	96 Test	38220090	24,500.00
CLS2719HU	human oncoprotein induced transcript 3,OIT3 ELISA Kit	96 Test	38220090	24,500.00
CLS2720HU	Human P27 protein ELISA Kit	96 Test	38220090	24,500.00
CLS2721HU	Human urinary bladder cancer antigen,UBC ELISA Kit	96 Test	38220090	24,500.00
CLS2722HU	Human Cyclin-D3 ELISA Kit	96 Test	38220090	24,500.00
CLS2723HU	Human melanoma metastasis surface adhesion molecule,MMSAM ELISA Kit	96 Test	38220090	24,500.00
CLS2724HU	Human Colon Cancer Antigen,CCA ELISA Kit	96 Test	38220090	24,500.00
CLS2725HU	Human c-sis ELISA Kit	96 Test	38220090	24,500.00
CLS2726HU	Human Melanoma Marker A,MART/Melan-A ELISA Kit	96 Test	38220090	24,500.00
CLS2727HU	Human tumor specific antigen,TSA ELISA Kit	96 Test	38220090	24,500.00
CLS2728HU	Human kappa immunoglobulin light chain,κ-IgLC ELISA Kit	96 Test	38220090	24,500.00
CLS2729HU	Human tumor-associated antigen,TAA ELISA Kit	96 Test	38220090	24,500.00
CLS2730HU	Human Fibroblast surface protein,FSP ELISA Kit	96 Test	38220090	24,500.00
CLS2731HU	Human tumor angiogenesis factors,TAF ELISA Kit	96 Test	38220090	24,500.00
CLS2732HU	Human c-myc Oncogene product,c-myc ELISA Kit	96 Test	38220090	24,500.00
CLS2733HU	Human nasopharyngeal carcinoma,NPC ELISA Kit	96 Test	38220090	24,500.00
CLS2734HU	Human anti-neuroblastoma-antibody,NB-Ab ELISA Kit	96 Test	38220090	24,500.00
CLS2735HU	Human cytokeratin 20,CK-20 ELISA Kit	96 Test	38220090	24,500.00
CLS2736HU	Human Semaphorin 4G (SEMA4G)ELISA Kit	96 Test	38220090	24,500.00
CLS2737HU	Human Stromelysin-3,ST3 ELISA Kit	96 Test	38220090	24,500.00
CLS2738HU	Human nonsmall cell lung cancer/Lung tumor Antigen,LTA ELISA Kit	96 Test	38220090	24,500.00
CLS2739HU	Human Carcinoembryonic Ferritin,CEF ELISA Kit	96 Test	38220090	24,500.00
CLS2740HU	Human Centromere Protein,CENP-B ELISA Kit	96 Test	38220090	24,500.00
CLS2741HU	Human Urocortin-2,UCN2/SRP LISA Kit	96 Test	38220090	24,500.00
CLS2742HU	Human Urocortin-3,UCN3/SPC LISA Kit	96 Test	38220090	24,500.00
CLS2743HU	Human Thyroid receptor-interacting protein 13,TRIP13/16E1BP LISA Kit	96 Test	38220090	24,500.00
CLS2744HU	human colicin ELISA Kit	96 Test	38220090	24,500.00
CLS2745HU	Human Amebiasis ELISA Kit	96 Test	38220090	24,500.00
CLS2746HU	human schistosoma ELISA Kit	96 Test	38220090	24,500.00
CLS2747HU	Human chlamydial protease-like activity factor,CPAF ELISA Kit	96 Test	38220090	24,500.00
CLS2748HU	Human antibody to group A streptococcal polysaccharide,ASP ELISA Kit	96 Test	38220090	24,500.00
CLS2749HU	Human Diphtheria antibody ELISA Kit	96 Test	38220090	24,500.00
CLS2750HU	Human Legionella antibody IgA,LP Ab-IgA ELISA Kit	96 Test	38220090	24,500.00
CLS2751HU	Human Apelin receptor,APLNR ELISA Kit	96 Test	38220090	24,500.00
CLS2752HU	Human GRB2-related adapter protein 2(GRAP2/P38) ELISA Kit	96 Test	38220090	24,500.00
CLS2753HU	Human Voltage gated potassium channel subunit beta-2,KCNAB2/KCNK2 ELISA Kit	96 Test	38220090	24,500.00
CLS2754HU	Human Potassium channel subfamily K member 1,KCNK1 ELISA Kit	96 Test	38220090	24,500.00
CLS2755HU	Human Potassium channel subfamily K member 2,KCNK2 ELISA Kit	96 Test	38220090	24,500.00
CLS2756HU	Human Potassium channel subfamily K member 3,KCNK3 ELISA Kit	96 Test	38220090	24,500.00
CLS2757HU	Human Potassium channel subfamily K member 4,KCNK4 ELISA Kit	96 Test	38220090	24,500.00
CLS2758HU	Human Potassium channel subfamily K member 5,KCNK5 ELISA Kit	96 Test	38220090	24,500.00
CLS2759HU	Human Potassium channel subfamily K member 6,KCNK6 ELISA Kit	96 Test	38220090	24,500.00

Cat.No.	Product Description	Pack Size	HSN	Unit Price
CLS2760HU	Human Potassium channel subfamily K member 7,KCNK7 ELISA Kit	96 Test	38220090	24,500.00
CLS2761HU	Human Inhibin binding protein,INHBP ELISA Kit	96 Test	38220090	24,500.00
CLS2762HU	Human Potassium channel subfamily K member 10,KCNK10 ELISA Kit	96 Test	38220090	24,500.00
CLS2763HU	Human Potassium channel subfamily K member 12,KCNK12 ELISA Kit	96 Test	38220090	24,500.00
CLS2764HU	Human Heat Shock Protein 40,HSP-40 ELISA Kit	96 Test	38220090	24,500.00
CLS2765HU	Human Anti-trypsin,AT ELISA Kit	96 Test	38220090	24,500.00
CLS2766HU	Human Vacuolating cytotoxin A,VacA ELISA Kit	96 Test	38220090	24,500.00
CLS2767HU	Human Potassium channel subfamily K member 13,KCNK13 ELISA Kit	96 Test	38220090	24,500.00
CLS2768HU	Human tuberculosis antibody IgG,TB-Ab IgG ELISA Kit	96 Test	38220090	24,500.00
CLS2769HU	Human Heat Shock Protein 20,HSP-20 ELISA Kit	96 Test	38220090	24,500.00
CLS2770HU	Human Heat Shock Factor 1,HSF1 ELISA Kit	96 Test	38220090	24,500.00
CLS2771HU	Human Potassium channel subfamily K member 16,KCNK16 ELISA Kit	96 Test	38220090	24,500.00
CLS2772HU	Human Potassium channel subfamily K member 17,KCNK17 ELISA Kit	96 Test	38220090	24,500.00
CLS2773HU	Human listeriolysin O,LLO ELISA Kit	96 Test	38220090	24,500.00
CLS2774HU	Human hemagglutinin,HA ELISA Kit	96 Test	38220090	24,500.00
CLS2775HU	Human Potassium channel subfamily K member 18,KCNK18 ELISA Kit	96 Test	38220090	24,500.00
CLS2776HU	Human Nuclear respiratory factor 1,NRF1 ELISA Kit	96 Test	38220090	24,500.00
CLS2777HU	Human ATP-sensitive inward rectifier potassium channel 1,KCNJ1/ROM-K ELISA Kit	96 Test	38220090	24,500.00
CLS2778HU	Human anti-Bactericidal permeability increasing protein antibody,BPI-Ab ELISA Kit	96 Test	38220090	24,500.00
CLS2779HU	Human ATP-sensitive inward rectifier potassium channel 11,KCNJ11/Kir6.2 ELISA Kit	96 Test	38220090	24,500.00
CLS2780HU	Human Leptospira IgM ELISA Kit	96 Test	38220090	24,500.00
CLS2781HU	Human Leptospira IgG,Lep IgG ELISA Kit	96 Test	38220090	24,500.00
CLS2782HU	Human ATP-sensitive inward rectifier potassium channel 12,KCNJ12/Kir2.2 ELISA Kit	96 Test	38220090	24,500.00
CLS2783HU	Human Candida Albicans,C.albicans ELISA Kit	96 Test	38220090	24,500.00
CLS2784HU	Human Bullous Pemphigoid,BP ELISA Kit	96 Test	38220090	24,500.00
CLS2785HU	Human Inward rectifier potassium channel 13,KCNJ13 ELISA Kit	96 Test	38220090	24,500.00
CLS2786HU	Human Leukotriene B4 receptor 1,LTB4R ELISA Kit	96 Test	38220090	24,500.00
CLS2787HU	Human Staphylococcal protein A,SPA ELISA Kit	96 Test	38220090	24,500.00
CLS2788HU	Human latent transforming growth factor beta binding protein 1,LTBP1 ELISA Kit	96 Test	38220090	24,500.00
CLS2789HU	Human ATP-sensitive inward rectifier potassium channel 14,KCNJ14/Kir2.4 ELISA Kit	96 Test	38220090	24,500.00
CLS2790HU	Human latent transforming growth factor beta binding protein 3,LTBP3 ELISA Kit	96 Test	38220090	24,500.00
CLS2791HU	Human ATP-sensitive inward rectifier potassium channel 15,KCNJ15/Kir4.2 ELISA Kit	96 Test	38220090	24,500.00
CLS2792HU	Human latent transforming growth factor beta binding protein 4,LTBP4 ELISA Kit	96 Test	38220090	24,500.00
CLS2793HU	Human Prostaglandin reductase 1,PTGR1 ELISA Kit	96 Test	38220090	24,500.00
CLS2794HU	Human Clathrin light chain B,CLTB ELISA Kit	96 Test	38220090	24,500.00
CLS2795HU	Human Inward rectifier potassium channel 18,KCNJ18 ELISA Kit	96 Test	38220090	24,500.00
CLS2796HU	Human soluble Factor-related Apoptosis,sFAS/Apo-1 ELISA Kit	96 Test	38220090	24,500.00
CLS2797HU	Human inhibitor of apoptosis,IAP ELISA Kit	96 Test	38220090	24,500.00
CLS2798HU	Human tumor necrosis factor-related apoptosis-inducing ligand 4,TRAIL-R4 ELISA Kit	96 Test	38220090	24,500.00
CLS2799HU	Human tumor necrosis factor-related apoptosis-inducing ligand 3,TRAIL-R3 ELISA Kit	96 Test	38220090	24,500.00

Cat.No.	Product Description	Pack Size	HSN	Unit Price
CLS2800HU	Human caenorhabditis elegans death gene, CED-3 ELISA Kit	96 Test	38220090	24,500.00
CLS2801HU	Human tumor necrosis factor-related apoptosis-inducing ligand 1, TRAIL-R1 ELISA Kit	96 Test	38220090	24,500.00
CLS2802HU	Humna anti-sperm protein 17 antibodies, Sp17 ELISA Kit	96 Test	38220090	24,500.00
CLS2803HU	Human Blocking antibody, BA ELISA Kit	96 Test	38220090	24,500.00
CLS2804HU	Human Inward rectifier potassium channel 2, KCNJ2 ELISA Kit	96 Test	38220090	24,500.00
CLS2805HU	Human basic fetoprotein, BFP ELISA Kit	96 Test	38220090	24,500.00
CLS2806HU	Human growth-associated protein 43, GAP-43 ELISA Kit	96 Test	38220090	24,500.00
CLS2807HU	Human Testosterone receptor, TR ELISA Kit	96 Test	38220090	24,500.00
CLS2808HU	Human placental protein, PP ELISA Kit	96 Test	38220090	24,500.00
CLS2809HU	Human anti-acrosin antibodies, ACR ELISA Kit	96 Test	38220090	24,500.00
CLS2810HU	Human anti-zona pellucida antibody, aZP ELISA Kit	96 Test	38220090	24,500.00
CLS2811HU	Human Herpes Gestation, HG ELISA Kit	96 Test	38220090	24,500.00
CLS2812HU	human eosinophil-associated ribonuclease A family member 1, EAR1 ELISA KIT	96 Test	38220090	24,500.00
CLS2813HU	human similar to RIKEN cDNA 3110050K21 gene ELISA Kit	96 Test	38220090	24,500.00
CLS2814HU	human similar to RIKEN cDNA 2610307008 gene ELISA Kit	96 Test	38220090	24,500.00
CLS2815HU	human similar to RIKEN cDNA A630077B13 gene ELISA Kit	96 Test	38220090	24,500.00
CLS2816HU	human similar to RIKEN cDNA 2010109K09 gene ELISA KIT	96 Test	38220090	24,500.00
CLS2817HU	human hypothetical protein LOC433328 ELISA Kit	96 Test	38220090	24,500.00
CLS2818HU	human lymphocyte antigen 6 complex locus A, Ly6a ELISA Kit	96 Test	38220090	24,500.00
CLS2819HU	human Hypothetical protein LOC677168 ELISA Kit	96 Test	38220090	24,500.00
CLS2820HU	Human lumican, LUM ELISA Kit	96 Test	38220090	24,500.00
CLS2821HU	human hypothetical protein LOC677340 ELISA Kit	96 Test	38220090	24,500.00
CLS2822HU	human serine/cysteine peptidase inhibitor clade A member 3G, Serpina3g ELISA Kit	96 Test	38220090	24,500.00
CLS2823HU	human mixed lineage kinase domain-like, MLKL ELISA Kit	96 Test	38220090	24,500.00
CLS2824HU	human peroxisome proliferative activated receptor gama coactivator 1 alpha, PPARGC1 ELISA Kit	96 Test	38220090	24,500.00
CLS2825HU	human snail homolog 2, SNAI2 ELISA Kit	96 Test	38220090	24,500.00
CLS2826HU	human claudin 14, CLDN14 ELISA Kit	96 Test	38220090	24,500.00
CLS2827HU	human progestin and adipoQ receptor family member VII, PAQR7 ELISA Kit	96 Test	38220090	24,500.00
CLS2828HU	Human Wiskott-Aldrich syndrome protein, WASP ELISA Kit	96 Test	38220090	24,500.00
CLS2829HU	human similar to RIKEN cDNA 4933429F08 gene ELISA Kit	96 Test	38220090	24,500.00
CLS2830HU	human REST corepressor 3, RCOR3 ELISA Kit	96 Test	38220090	24,500.00
CLS2831HU	human Mus musculus similar to 60S ribosomal protein L12, LOC382344 ELISA kit	96 Test	38220090	24,500.00
CLS2832HU	human interferon activated gene 205, Ifi205 ELISA Kit	96 Test	38220090	24,500.00
CLS2833HU	human similar to cDNA sequence BC027382 ELISA Kit	96 Test	38220090	24,500.00
CLS2834HU	Human para-aminobenzoic acid, PABA ELISA Kit	96 Test	38220090	24,500.00
CLS2835HU	human similar to RIKEN cDNA 4931408D14 gene ELISA kit	96 Test	38220090	24,500.00
CLS2836HU	Human nonmethylated oligonucleotide, NON ELISA Kit	96 Test	38220090	24,500.00
CLS2837HU	Human amiodarone, AD ELISA Kit	96 Test	38220090	24,500.00
CLS2838HU	Human TU3A Protein ELISA Kit	96 Test	38220090	24,500.00
CLS2839HU	Human uridine diphosphate glucuronosyltransferase 2 family polypeptide B4, UGT2B4 ELISA Kit	96 Test	38220090	24,500.00
CLS2840HU	Human CCAAT/enhancer binding protein delta, C/EBPδ ELISA Kit	96 Test	38220090	24,500.00
CLS2841HU	Human CCAAT/enhancer binding protein epsilon, C/EBPε ELISA Kit	96 Test	38220090	24,500.00

Cat.No.	Product Description	Pack Size	HSN	Unit Price
CLS2842HU	Human 20-hydroxyeicosatetraenoic acid,12-HETE ELISA Kit	96 Test	38220090	24,500.00
CLS2843HU	Human N-terminal extein,Ext-N ELISA Kit	96 Test	38220090	24,500.00
CLS2844HU	Human replication protein A,RPA-70 ELISA Kit	96 Test	38220090	24,500.00
CLS2845HU	Human Follistatin-related protein 3(FSTL3)ELISA Kit	96 Test	38220090	24,500.00
CLS2846HU	Human Tumor necrosis factor soluble receptor II ,TNFsR-II ELISA KIT	96 Test	38220090	24,500.00
CLS2847HU	Human major histocompatibility complex class I chain-related gene D,MICD ELISA Kit	96 Test	38220090	24,500.00
CLS2848HU	Human microtubule-associated protein light chain 3 (MAPLC3) ELISA Kit	96 Test	38220090	24,500.00
CLS2849HU	Human cecropin B,CecB ELISA Kit	96 Test	38220090	24,500.00
CLS2850HU	Human placenta protein14 · PP14 Elisa Kit	96 Test	38220090	24,500.00
CLS2851HU	Human regenerating gene IV,REG-4 ELISA Kit	96 Test	38220090	24,500.00
CLS2852HU	Human neutrophil granules antibody,NG-Ab ELISA Kit	96 Test	38220090	24,500.00
CLS2853HU	Human Semaphorin 5A (SEMA5A)ELISA Kit	96 Test	38220090	24,500.00
CLS2854HU	Human Semaphorin 3C (SEMA3C)ELISA Kit	96 Test	38220090	24,500.00
CLS2855HU	Human Leucostix,LE ELISA Kit	96 Test	38220090	24,500.00
CLS2856HU	Human Leukotriene,LT ELISA Kit	96 Test	38220090	24,500.00
CLS2857HU	Human cytoovillin/ezrin ELISA KIT	96 Test	38220090	24,500.00
CLS2858HU	Human Acrine Orange,AO ELISA Kit	96 Test	38220090	24,500.00
CLS2859HU	Human interferon-inducible protein 16,IFI16/p16 ELISA KIT	96 Test	38220090	24,500.00
CLS2860HU	Human Beta-naphthol, β -Nph ELISA Kit	96 Test	38220090	24,500.00
CLS2861HU	Human α -bungarotoxin, α -BGT ELISA KIT	96 Test	38220090	24,500.00
CLS2862HU	Human β 2-Glycoprotein I , β 2GP I ELISA Kit	96 Test	38220090	24,500.00
CLS2863HU	Human X linkedspndyloepiphysealdysplasiatarda ,SEDL ELISA Kit	96 Test	38220090	24,500.00
CLS2864HU	Human T cell receptor,TCR ELISA Kit	96 Test	38220090	24,500.00
CLS2865HU	human T-Subset ELISA Kit	96 Test	38220090	24,500.00
CLS2866HU	Human Sodium/Glucose Cotransporter 3 (SGLT3)ELISA kit	96 Test	38220090	24,500.00
CLS2867HU	Human 6-phosphofructokinase, liver type(PFKL)ELISA kit	96 Test	38220090	24,500.00
CLS2868HU	Human Sodium/Glucose Cotransporter 4 (SGLT4)ELISA kit	96 Test	38220090	24,500.00
CLS2869HU	Human DNA methyltransferase,DNAM ELISA Kit	96 Test	38220090	24,500.00
CLS2870HU	Human FMS-like tyrosine kinase 3 receptor,FIt-3R ELISA Kit	96 Test	38220090	24,500.00
CLS2871HU	Human 5,10methylenetetrahydrofolatereductase(MTHFR) ELISA Kit	96 Test	38220090	24,500.00
CLS2872HU	Human Zinc finger CCCH domain-containing protein 15,ZC3H15 ELISA Kit	96 Test	38220090	24,500.00
CLS2873HU	Human Sodium/Glucose Cotransporter 5 (SGLT5)ELISA kit	96 Test	38220090	24,500.00
CLS2874HU	Human Proteoglycan,PG ELISA	96 Test	38220090	24,500.00
CLS2875HU	Human triple-helical peptide,THP ELISA Kit	96 Test	38220090	24,500.00
CLS2876HU	Human carbohydrate antigen153, CA153 ELISA Kit	96 Test	38220090	24,500.00
CLS2877HU	Human carbohydrate antigen199, CA199 ELISA Kit	96 Test	38220090	24,500.00
CLS2878HU	Human Specific Immunoglobulin E,sIgE ELISA kit	96 Test	38220090	24,500.00
CLS2879HU	Human cytotoxin,CTX ELISA Kit	96 Test	38220090	24,500.00
CLS2880HU	Human Protein O-Glucosyltransferase 1 (POGLUT1)ELISA kit	96 Test	38220090	24,500.00
CLS2881HU	Human Inward rectifier potassium channel 4,KCNJ4 ELISA Kit	96 Test	38220090	24,500.00
CLS2882HU	Human ghcagons-like pepfide ,GLP ELISA Kit	96 Test	38220090	24,500.00
CLS2883HU	Human acidic fibroblast growth factor ,aFGF ELISA Kit	96 Test	38220090	24,500.00
CLS2884HU	Human Fibulin,FBLN ELISA Kit	96 Test	38220090	24,500.00

Cat.No.	Product Description	Pack Size	HSN	Unit Price
CLS2885HU	Human receptor-binding cancer antigen expressed on SiSo cells · RCAS1 ELISA kit	96 Test	38220090	24,500.00
CLS2886HU	Human merozoite surface protein-1 ,MSP-1 ELISA kit	96 Test	38220090	24,500.00
CLS2887HU	Human Prostate secretory protein94,PSP94 ELISA kit	96 Test	38220090	24,500.00
CLS2888HU	Human Adenylate Cyclase 1, Brain (ADCY1)ELISA Kit	96 Test	38220090	24,500.00
CLS2889HU	Human Histone deacetylase 2,HDAC2 ELISA KIT	96 Test	38220090	24,500.00
CLS2890HU	Human growth-regulated oncogene 1,GRO-1 ELISA Kit	96 Test	38220090	24,500.00
CLS2891HU	Human peptidyl-tRNA hydrolase,PTRH ELISA Kit	96 Test	38220090	24,500.00
CLS2892HU	Human Peptidoglycan recognition proteins,PGRPs ELISA Kit	96 Test	38220090	24,500.00
CLS2893HU	Human Adenylate Cyclase 8, Brain (ADCY8)ELISA Kit	96 Test	38220090	24,500.00
CLS2894HU	Human soluble transferrin receptor1,sTfR1 ELISA Kit	96 Test	38220090	24,500.00
CLS2895HU	Human soluble cell adhesion molecule 26,sCD26 ELISA KIT	96 Test	38220090	24,500.00
CLS2896HU	Human soluble tumor necrosis factor 1,sTNF-1 ELISA Kit	96 Test	38220090	24,500.00
CLS2897HU	Human Attacin,Att ELISA KIT	96 Test	38220090	24,500.00
CLS2898HU	Human 6-phosphofructokinase type C,PFKC ELISA Kit	96 Test	38220090	24,500.00
CLS2899HU	Human Lipocalin 1 (LCN1) ELISA Kit	96 Test	38220090	24,500.00
CLS2900HU	Human Histone deacetylase 10,HDAC10 ELISA KIT	96 Test	38220090	24,500.00
CLS2901HU	Human Semaphorin 4A (SEMA4A)ELISA Kit	96 Test	38220090	24,500.00
CLS2902HU	Human muscarinic acetylcholine receptor M1,M-AChR M1 ELISA Kit	96 Test	38220090	24,500.00
CLS2903HU	Human muscarinic acetylcholine receptor M2,M-AChR M2 ELISA Kit	96 Test	38220090	24,500.00
CLS2904HU	Human Chlamydia pneumoniae IgA,Cpn IgA ELISA Kit	96 Test	38220090	24,500.00
CLS2905HU	Human Chlamydia pneumoniae IgE,Cpn IgE ELISA Kit	96 Test	38220090	24,500.00
CLS2906HU	Human Lys-63-specific deubiquitinase BRCC36,BRCC3/BRCC36 ELISA Kit	96 Test	38220090	24,500.00
CLS2907HU	Human Protein Tyrosine Phosphatase Receptor Type T (PTPRT)ELISA kit	96 Test	38220090	24,500.00
CLS2908HU	Human GRB10-interacting GYF protein 2(GIGYF2)ELISA kit	96 Test	38220090	24,500.00
CLS2909HU	Human rudimental BSA checkup ELISA Kit	96 Test	38220090	24,500.00
CLS2910HU	Human apoptosis inhibitory protein,AIP ELISA kit	96 Test	38220090	24,500.00
CLS2911HU	Human N-Acetyl Alpha-D-Glucosaminidase (NAGLU)ELISA kit	96 Test	38220090	24,500.00
CLS2912HU	Human CYR61 Cysteine-rich protein 61,Cyr 61 ELISA Kit	96 Test	38220090	24,500.00
CLS2913HU	Human Fc Fragment Of IgG Binding Protein (FcγBP)ELISA kit	96 Test	38220090	24,500.00
CLS2914HU	Human Histone deacetylase 11,HDAC11 ELISA KIT	96 Test	38220090	24,500.00
CLS2915HU	Human Rhinovirus,Rhv ELISA Kit	96 Test	38220090	24,500.00
CLS2916HU	Human basic fibroblast growth factor receptor ,bFGFR ELISA Kit	96 Test	38220090	24,500.00
CLS2917HU	Human Phosphofructokinase,PFK ELISA Kit	96 Test	38220090	24,500.00
CLS2918HU	Human squamous cell carcinoma antibody,SCC-Ab ELISA Kit	96 Test	38220090	24,500.00
CLS2919HU	Human O-Fucosylpeptide-3-Beta-N-Acetylglucosaminyltransferase (RFNG)ELISA kit	96 Test	38220090	24,500.00
CLS2920HU	Human Heparanase1,HPA1 ELISA kit	96 Test	38220090	24,500.00
CLS2921HU	Human Zinc Finger Homeobox Protein 4 (ZFH4)ELISA kit	96 Test	38220090	24,500.00
CLS2922HU	Human Cystatin SN,Cys-SN ELISA Kit	96 Test	38220090	24,500.00
CLS2923HU	Human thymus independent antigen,TI-Ag ELISA Ki	96 Test	38220090	24,500.00
CLS2924HU	Human carbohydrate antigen211, CA211 ELISA Kit	96 Test	38220090	24,500.00
CLS2925HU	Human Thromboxane B3,TX-B3 ELISA Kit	96 Test	38220090	24,500.00
CLS2926HU	Human platelet-associated immunoglobulinsA,PAIgA ELISA Kit	96 Test	38220090	24,500.00
CLS2927HU	Human platelet-associated immunoglobulinsG,PAIgG ELISA Kit	96 Test	38220090	24,500.00

Cat.No.	Product Description	Pack Size	HSN	Unit Price
CLS2928HU	Human Phosphoglycerate Dehydrogenase (PHGDH)ELISA kit	96 Test	38220090	24,500.00
CLS2929HU	Human Sodium/Glucose Cotransporter 1 (SGLT1)ELISA kit	96 Test	38220090	24,500.00
CLS2930HU	Human FLU-H5 ELISA Kit	96 Test	38220090	24,500.00
CLS2931HU	Human soluble vascular adhesion protein-1,sVAP-1 ELISA Kit	96 Test	38220090	24,500.00
CLS2932HU	Human ovarian cancer antigenX1,OVX1 ELISA Kit	96 Test	38220090	24,500.00
CLS2933HU	Human Neural cell adhesion molecule,NCAM ELISA Kit	96 Test	38220090	24,500.00
CLS2934HU	Human islet cell antigen,ICAg ELISA Kit	96 Test	38220090	24,500.00
CLS2935HU	Human staphylococcal protein A,SPA ELISA Kit	96 Test	38220090	24,500.00
CLS2936HU	Human leukocyte antigen ,HLA ELISA Kit	96 Test	38220090	24,500.00
CLS2937HU	Human Granulocyte Colony Stimulating Factor Receptor,G-CSFR ELISA Kit	96 Test	38220090	24,500.00
CLS2938HU	Human Hydrogen Sulphide,H2S ELISA Kit	96 Test	38220090	24,500.00
CLS2939HU	Human Cystatin S,Cys-S ELISA Kit	96 Test	38220090	24,500.00
CLS2940HU	Human epidermal Fatty acid binding protein,E-FABP ELISA Kit	96 Test	38220090	24,500.00
CLS2941HU	Human Infectiousmononucleosis,IM ELISA Kit	96 Test	38220090	24,500.00
CLS2942HU	Human dengue fever IgG,DF-IgG ELISA Kit	96 Test	38220090	24,500.00
CLS2943HU	Human Adenylate Cyclase 6, Brain (ADCY6)ELISA Kit	96 Test	38220090	24,500.00
CLS2944HU	Human Interleukin 24,IL-24 ELISA KIT	96 Test	38220090	24,500.00
CLS2945HU	Human Interleukin 20,IL-20 ELISA KIT	96 Test	38220090	24,500.00
CLS2946HU	Human Interleukin 23 receptor,IL-23R ELISA Kit	96 Test	38220090	24,500.00
CLS2947HU	Human G protein-activated inward rectifier potassium channel 4,KCNJ5/GIRK4 ELISA Kit	96 Test	38220090	24,500.00
CLS2948HU	Human DNA methyltransferase3α,DNAM3α ELISA Kit	96 Test	38220090	24,500.00
CLS2949HU	Human DNA methyltransferase 1,DNAM1 ELISA Kit	96 Test	38220090	24,500.00
CLS2950HU	Human uncoupling protein 2 antibody, UCP2-Ab ELISA Kit	96 Test	38220090	24,500.00
CLS2951HU	Human Infectiousmononucleosis IgA · IM-IgA ELISA Kit	96 Test	38220090	24,500.00
CLS2952HU	Human Infectiousmononucleosis IgM · IM-IgM ELISA Kit	96 Test	38220090	24,500.00
CLS2953HU	Human Infectiousmononucleosis IgG · IM-IgG ELISA Kit	96 Test	38220090	24,500.00
CLS2954HU	Human Infectiousmononucleosis antibody · IM-Ab ELISA Kit	96 Test	38220090	24,500.00
CLS2955HU	Human dipeptidyl peptidase 8,DPP8 ELISA Kit	96 Test	38220090	24,500.00
CLS2956HU	Human Phospho-Polo-like kinase 1,P-PLK1 ELISA Kit	96 Test	38220090	24,500.00
CLS2957HU	Human reticulin IgG ELISA Kit	96 Test	38220090	24,500.00
CLS2958HU	Human reticulin IgA ELISA Kit	96 Test	38220090	24,500.00
CLS2959HU	Human Polo-like kinase 1,PLK1 ELISA Kit	96 Test	38220090	24,500.00
CLS2960HU	Human targeted ribonuclease, TR ELISA	96 Test	38220090	24,500.00
CLS2961HU	Human Adenylate Cyclase 7, Brain (ADCY7)ELISA Kit	96 Test	38220090	24,500.00
CLS2962HU	Human Glucoside Xylosyltransferase 1 (GXylT1)ELISA kit	96 Test	38220090	24,500.00
CLS2963HU	Human Glucoside Xylosyltransferase 2 (GXylT2)ELISA kit	96 Test	38220090	24,500.00
CLS2964HU	Human Phosphoglucomutase 2 (PGM2)ELISA kit	96 Test	38220090	24,500.00
CLS2965HU	Human Phosphoglucomutase 2 Like Protein 1 (PGM2L1)ELISA kit	96 Test	38220090	24,500.00
CLS2966HU	Human Phosphoglucomutase 3 (PGM3)ELISA kit	96 Test	38220090	24,500.00
CLS2967HU	Human Phosphoglucomutase 5 (PGM5)ELISA kit	96 Test	38220090	24,500.00
CLS2968HU	Human Glucose Transporter 10 (GLUT10)ELISA kit	96 Test	38220090	24,500.00
CLS2969HU	Human Glucose Transporter 11 (GLUT11)ELISA kit	96 Test	38220090	24,500.00
CLS2970HU	Human Glucose Transporter 12 (GLUT12)ELISA kit	96 Test	38220090	24,500.00
CLS2971HU	Human Glucose Transporter 14 (GLUT14)ELISA kit	96 Test	38220090	24,500.00
CLS2972HU	Human Glucose Transporter 2 (GLUT2)ELISA kit	96 Test	38220090	24,500.00
CLS2973HU	Human Glucose Transporter 5 (GLUT5)ELISA kit	96 Test	38220090	24,500.00
CLS2974HU	Human Glucose Transporter 6 (GLUT6)ELISA kit	96 Test	38220090	24,500.00
CLS2975HU	Human Glucose Transporter 7 (GLUT7)ELISA kit	96 Test	38220090	24,500.00
CLS2976HU	Human Glucose Transporter 8 (GLUT8)ELISA kit	96 Test	38220090	24,500.00
CLS2977HU	Human Glucose Transporter 9 (GLUT9)ELISA kit	96 Test	38220090	24,500.00

Cat.No.	Product Description	Pack Size	HSN	Unit Price
CLS2978HU	Human Acid Glucosidase Beta (AGb)ELISA kit	96 Test	38220090	24,500.00
CLS2979HU	Human Aspartylglucosaminidase(AGA)ELISA kit	96 Test	38220090	24,500.00
CLS2980HU	Human Carcinoembryonic Antigen Related Cell Adhesion Molecule 1 (CEACAM1)ELISA kit	96 Test	38220090	24,500.00
CLS2981HU	Human Carcinoembryonic Antigen Related Cell Adhesion Molecule 6 (CEACAM6)ELISA kit	96 Test	38220090	24,500.00
CLS2982HU	Human Carcinoembryonic Antigen Related Cell Adhesion Molecule 7 (CEACAM7)ELISA kit	96 Test	38220090	24,500.00
CLS2983HU	Human Carcinoembryonic Antigen Related Cell Adhesion Molecule 8 (CEACAM8)ELISA kit	96 Test	38220090	24,500.00
CLS2984HU	Human Interleukin 1 Receptor Associated Kinase 2 (IRAK2)ELISA kit	96 Test	38220090	24,500.00
CLS2985HU	Human Leukocyte Elastase Inhibitor (LEI)ELISA kit	96 Test	38220090	24,500.00
CLS2986HU	Human Sirtuin 7 (SIRT7)ELISA kit	96 Test	38220090	24,500.00
CLS2987HU	Human BMP And Activin Membrane Bound Inhibitor Homolog (BAMBI)ELISA kit	96 Test	38220090	24,500.00
CLS2988HU	Human Fibroblast Growth Factor 15 (FGF15)ELISA kit	96 Test	38220090	24,500.00
CLS2989HU	Human Protein Tyrosine Phosphatase Receptor Type G (PTPRG)ELISA kit	96 Test	38220090	24,500.00
CLS2990HU	Human Phospholipase A2, Calcium Independent (iPLA2)ELISA kit	96 Test	38220090	24,500.00
CLS2991HU	Human ATPase, Ca ⁺⁺ Transporting, Plasma Membrane 2 (ATP2B2)ELISA kit	96 Test	38220090	24,500.00
CLS2992HU	Human Glycyl tRNA Synthetase (GARS)ELISA kit	96 Test	38220090	24,500.00
CLS2993HU	Human Bone Morphogenetic Protein 1 (BMP1)ELISA kit	96 Test	38220090	24,500.00
CLS2994HU	Human Bone Morphogenetic Protein 10 (BMP10)ELISA kit	96 Test	38220090	24,500.00
CLS2995HU	Human Bone Morphogenetic Protein 5 (BMP5)ELISA kit	96 Test	38220090	24,500.00
CLS2996HU	Human BMP Binding Endothelial Regulator (BMPER)ELISA kit	96 Test	38220090	24,500.00
CLS2997HU	Human Caspase 11 (CASP11)ELISA kit	96 Test	38220090	24,500.00
CLS2998HU	Human Caspase 13 (CASP13)ELISA kit	96 Test	38220090	24,500.00
CLS2999HU	Human Caspase 14 (CASP14)ELISA kit	96 Test	38220090	24,500.00
CLS3000HU	Human Caspase 2 (CASP2)ELISA kit	96 Test	38220090	24,500.00
CLS3001HU	Human Caspase 6 (CASP6)ELISA kit	96 Test	38220090	24,500.00
CLS3002HU	Human Caspase 7 (CASP7)ELISA kit	96 Test	38220090	24,500.00
CLS3003HU	Human Myosin Light Chain 9, Regulatory (MYL9)ELISA kit	96 Test	38220090	24,500.00
CLS3004HU	Human Creatine Transporter (CRT)ELISA kit	96 Test	38220090	24,500.00
CLS3005HU	Human Contactin 1 (CNTN1)ELISA kit	96 Test	38220090	24,500.00
CLS3006HU	Human Mercaptopyruvate Sulfurtransferase (MPST)ELISA kit	96 Test	38220090	24,500.00
CLS3007HU	Human Adenylate Cyclase 3, Brain (ADCY3)ELISA Kit	96 Test	38220090	24,500.00
CLS3008HU	Human Neuron Navigator 2 (NAV2)ELISA kit	96 Test	38220090	24,500.00
CLS3009HU	Human Carbonic Anhydrase VB, Mitochondrial (CA5B)ELISA kit	96 Test	38220090	24,500.00
CLS3010HU	Human Carbonic Anhydrase IX (CA9)ELISA kit	96 Test	38220090	24,500.00
CLS3011HU	Human Semaphorin 5B (SEMA5B)ELISA Kit	96 Test	38220090	24,500.00
CLS3012HU	Human Gastrokine 1 (GKN1)ELISA kit	96 Test	38220090	24,500.00
CLS3013HU	Human Lipase, Gastric (LIPF)ELISA kit	96 Test	38220090	24,500.00
CLS3014HU	Human Cell Division Cycle Protein 23 (CDC23)ELISA kit	96 Test	38220090	24,500.00
CLS3015HU	Human Cytohesin Interacting Protein (CYTIP)ELISA kit	96 Test	38220090	24,500.00
CLS3016HU	Human Cytochrome P450 1A2 (CYP1A2)ELISA kit	96 Test	38220090	24,500.00
CLS3017HU	Human Cytochrome P450 21B (CYP21B)ELISA kit	96 Test	38220090	24,500.00
CLS3018HU	Human Cyclin T (CCNT)ELISA kit	96 Test	38220090	24,500.00
CLS3019HU	Human Troponin T Type 2, Cardiac (TNNT2)ELISA kit	96 Test	38220090	24,500.00
CLS3020HU	Human Thymopoietin (TMPO)ELISA kit	96 Test	38220090	24,500.00
CLS3021HU	Human Transgelin (TAGLN)ELISA kit	96 Test	38220090	24,500.00
CLS3022HU	Human Transgelin 2 (TAGLN2)ELISA kit	96 Test	38220090	24,500.00
CLS3023HU	Human Transgelin 3 (TAGLN3)ELISA kit	96 Test	38220090	24,500.00
CLS3024HU	Human Fibroblast Growth Factor 7 (FGF7)ELISA kit	96 Test	38220090	24,500.00

Cat.No.	Product Description	Pack Size	HSN	Unit Price
CLS3025HU	Human Leukocyte Specific Transcript 1 (LST1)ELISA kit	96 Test	38220090	24,500.00
CLS3026HU	Human Leukocyte Cell Derived Chemotaxin 2 (LECT2)ELISA kit	96 Test	38220090	24,500.00
CLS3027HU	Human Claudin 6 (CLDN6)ELISA kit	96 Test	38220090	24,500.00
CLS3028HU	Human Claudin 7 (CLDN7)ELISA kit	96 Test	38220090	24,500.00
CLS3029HU	Human Claudin 8 (CLDN8)ELISA kit	96 Test	38220090	24,500.00
CLS3030HU	Human Claudin 9 (CLDN9)ELISA kit	96 Test	38220090	24,500.00
CLS3031HU	Human Claudin 10 (CLDN10)ELISA kit	96 Test	38220090	24,500.00
CLS3032HU	Human Claudin 11 (CLDN11)ELISA kit	96 Test	38220090	24,500.00
CLS3033HU	Human Claudin 12 (CLDN12)ELISA kit	96 Test	38220090	24,500.00
CLS3034HU	Human Claudin 15 (CLDN15)ELISA kit	96 Test	38220090	24,500.00
CLS3035HU	Human Claudin 16 (CLDN16)ELISA kit	96 Test	38220090	24,500.00
CLS3036HU	Human Claudin 17 (CLDN17)ELISA kit	96 Test	38220090	24,500.00
CLS3037HU	Human Claudin 19 (CLDN19)ELISA kit	96 Test	38220090	24,500.00
CLS3038HU	Human Claudin 20 (CLDN20)ELISA kit	96 Test	38220090	24,500.00
CLS3039HU	Human Claudin 24 (CLDN24)ELISA kit	96 Test	38220090	24,500.00
CLS3040HU	Human Claudin 22 (CLDN22)ELISA kit	96 Test	38220090	24,500.00
CLS3041HU	Human Surfactant Associated Protein J (SPJ)ELISA Kit	96 Test	38220090	24,500.00
CLS3042HU	Human Furin (FUR)ELISA kit	96 Test	38220090	24,500.00
CLS3043HU	Human Proprotein Convertase Subtilisin/Kexin Type 1 (PCSK1)ELISA kit	96 Test	38220090	24,500.00
CLS3044HU	Human Proprotein Convertase Subtilisin/Kexin Type 5 (PCSK5)ELISA kit	96 Test	38220090	24,500.00
CLS3045HU	Human Sex Determining Region Y Box Protein 9 (SOX9)ELISA kit	96 Test	38220090	24,500.00
CLS3046HU	Human Sex Determining Region Y Box Protein 1 (SOX1)ELISA kit	96 Test	38220090	24,500.00
CLS3047HU	Human Sex Determining Region Y Box Protein 18 (SOX918)ELISA kit	96 Test	38220090	24,500.00
CLS3048HU	Human Plakophilin 4 (PKP4)ELISA kit	96 Test	38220090	24,500.00
CLS3049HU	Human Plakophilin 3 (PKP3)ELISA kit	96 Test	38220090	24,500.00
CLS3050HU	Human Plakophilin 2 (PKP2)ELISA kit	96 Test	38220090	24,500.00
CLS3051HU	Human Plakophilin 1 (PKP1)ELISA kit	96 Test	38220090	24,500.00
CLS3052HU	Human Ubiquitin Specific Peptidase 8 (USP8)ELISA kit	96 Test	38220090	24,500.00
CLS3053HU	Human USP6 N-Terminal Like Protein (USP6NL)ELISA kit	96 Test	38220090	24,500.00
CLS3054HU	Human Deubiquitinating Enzyme 3 (DUB3)ELISA kit	96 Test	38220090	24,500.00
CLS3055HU	Human Ferritin Heavy Polypeptide (FTH)ELISA kit	96 Test	38220090	24,500.00
CLS3056HU	Human Pim-1 Oncogene (PIM1)ELISA Kit	96 Test	38220090	24,500.00
CLS3057HU	Human Pim-2 Oncogene (PIM2) ELISA Kit	96 Test	38220090	24,500.00
CLS3058HU	Human Pim-3 Oncogene (PIM3)ELISA Kit	96 Test	38220090	24,500.00
CLS3059HU	Human Wingless Type MMTV Integration Site Family, Member 7A (WNT7A)ELISA Kit	96 Test	38220090	24,500.00
CLS3060HU	Human Wingless Type MMTV Integration Site Family, Member 2 (WNT2)ELISA Kit	96 Test	38220090	24,500.00
CLS3061HU	Human Wingless Type MMTV Integration Site Family, Member 3 (WNT3)ELISA Kit	96 Test	38220090	24,500.00
CLS3062HU	Human Wingless Type MMTV Integration Site Family, Member 10A (WNT10A)ELISA Kit	96 Test	38220090	24,500.00
CLS3063HU	Human WNT Inhibitory Factor 1 (WIF1)ELISA Kit	96 Test	38220090	24,500.00
CLS3064HU	Human Frizzled Homolog 5 (FZD5)ELISA Kit	96 Test	38220090	24,500.00
CLS3065HU	Human Frizzled Homolog 7 (FZD7)ELISA Kit	96 Test	38220090	24,500.00
CLS3066HU	Human Frizzled Homolog 10 (FZD10)ELISA Kit	96 Test	38220090	24,500.00
CLS3067HU	Human Frizzled Homolog 9 (FZD9)ELISA Kit	96 Test	38220090	24,500.00
CLS3068HU	Human Frizzled Homolog 6 (FZD6)ELISA Kit	96 Test	38220090	24,500.00
CLS3069HU	Human Frizzled Homolog 1 (FZD1)ELISA Kit	96 Test	38220090	24,500.00
CLS3070HU	Human Frizzled Homolog 2 (FZD2)ELISA Kit	96 Test	38220090	24,500.00
CLS3071HU	Human Frizzled Homolog 3 (FZD3)ELISA Kit	96 Test	38220090	24,500.00
CLS3072HU	Human Anoctamin 2 (ANO2)ELISA Kit	96 Test	38220090	24,500.00
CLS3073HU	Human Anoctamin 3 (ANO3)ELISA Kit	96 Test	38220090	24,500.00
CLS3074HU	Human Anoctamin 4 (ANO4)ELISA Kit	96 Test	38220090	24,500.00

Cat.No.	Product Description	Pack Size	HSN	Unit Price
CLS3075HU	Human Anoctamin 5 (ANO5)ELISA Kit	96 Test	38220090	24,500.00
CLS3076HU	Human Anoctamin 6 (ANO6)ELISA Kit	96 Test	38220090	24,500.00
CLS3077HU	Human Anoctamin 7 (ANO7)ELISA Kit	96 Test	38220090	24,500.00
CLS3078HU	Human Anoctamin 8 (ANO8)ELISA Kit	96 Test	38220090	24,500.00
CLS3079HU	Human Anoctamin 9 (ANO9)ELISA Kit	96 Test	38220090	24,500.00
CLS3080HU	Human Anoctamin 10 (ANO10)ELISA Kit	96 Test	38220090	24,500.00
CLS3081HU	Human Methionyl Aminopeptidase 1 (METAP1)ELISA Kit	96 Test	38220090	24,500.00
CLS3082HU	Human Methionyl Aminopeptidase 2 (METAP2)ELISA Kit	96 Test	38220090	24,500.00
CLS3083HU	Human Transcobalamin I (TCN1)ELISA Kit	96 Test	38220090	24,500.00
CLS3084HU	Human Thrombospondin 2 (TSP-2)ELISA Kit	96 Test	38220090	24,500.00
CLS3085HU	Human Catenin Alpha 1 (CTNNA1)ELISA Kit	96 Test	38220090	24,500.00
CLS3086HU	Human Semaphorin 3G (SEMA3G)ELISA Kit	96 Test	38220090	24,500.00
CLS3087HU	Human Catenin Alpha 2 (CTNNA2)ELISA Kit	96 Test	38220090	24,500.00
CLS3088HU	Human Catenin Alpha 3 (CTNNA3)ELISA Kit	96 Test	38220090	24,500.00
CLS3089HU	Human Sterol-O-Acyltransferase 1 (SOAT1)ELISA Kit	96 Test	38220090	24,500.00
CLS3090HU	Human Sterol-O-Acyltransferase 2 (SOAT2)ELISA Kit	96 Test	38220090	24,500.00
CLS3091HU	Human Carboxylesterase 1 (CES1)ELISA Kit	96 Test	38220090	24,500.00
CLS3092HU	Human Catenin delta 1 (CTNND1)ELISA Kit	96 Test	38220090	24,500.00
CLS3093HU	Human Anthrax Toxin Receptor 2 (ANTXR2)ELISA Kit	96 Test	38220090	24,500.00
CLS3094HU	Human Anthrax Toxin Receptor 1 (ANTXR1)ELISA Kit	96 Test	38220090	24,500.00
CLS3095HU	Human Replication Initiator 1 (REPIN1)ELISA Kit	96 Test	38220090	24,500.00
CLS3096HU	Human Transient Receptor Potential Cation Channel Subfamily V, Member 2 (TRPV2)ELISA Kit	96 Test	38220090	24,500.00
CLS3097HU	Human Ribonuclease III, Nuclear (RNASEN)ELISA Kit	96 Test	38220090	24,500.00
CLS3098HU	Human Defensin Alpha 5, Paneth Cell Specific (DEFA5)ELISA Kit	96 Test	38220090	24,500.00
CLS3099HU	Human Defensin Alpha 3, Neutrophil Specific (DEFA3)ELISA Kit	96 Test	38220090	24,500.00
CLS3100HU	Human Defensin Beta 127 (DEFB127)ELISA Kit	96 Test	38220090	24,500.00
CLS3101HU	Human Transmembrane Protein 27 (TMEM27)ELISA Kit	96 Test	38220090	24,500.00
CLS3102HU	Human Dolichol Kinase (DOLK)ELISA Kit	96 Test	38220090	24,500.00
CLS3103HU	Human Transmembrane Protein 2 (TMEM2)ELISA Kit	96 Test	38220090	24,500.00
CLS3104HU	Human Transmembrane Protein 5 (TMEM5)ELISA Kit	96 Test	38220090	24,500.00
CLS3105HU	Human Nucleophosmin 3 (NPM3)ELISA Kit	96 Test	38220090	24,500.00
CLS3106HU	Human Transmembrane Protein 2 Like Protein (TMEM2L)ELISA Kit	96 Test	38220090	24,500.00
CLS3107HU	Human Transmembrane Protein 1 (TMEM1)ELISA Kit	96 Test	38220090	24,500.00
CLS3108HU	Human Alkylglycerol Monooxygenase (AGMO)ELISA Kit	96 Test	38220090	24,500.00
CLS3109HU	Human Sphingomyelin Synthase 1 (SGMS1)ELISA Kit	96 Test	38220090	24,500.00
CLS3110HU	Human Clarin 3 (CLR3)ELISA Kit	96 Test	38220090	24,500.00
CLS3111HU	Human Glutaminyl Peptide Cyclotransferase (GPCT)ELISA Kit	96 Test	38220090	24,500.00
CLS3112HU	Human Plasmalemma Vesicle Associated Protein (PLVAP)ELISA Kit	96 Test	38220090	24,500.00
CLS3113HU	Human Cartilage Associated Protein (CRTAP)ELISA Kit	96 Test	38220090	24,500.00
CLS3114HU	Human Translocator Protein 2 (TSPO2)ELISA Kit	96 Test	38220090	24,500.00
CLS3115HU	Human Proteasome Subunit Beta Type 6 (PSMB6)ELISA Kit	96 Test	38220090	24,500.00
CLS3116HU	Human Large Multifunctional Peptidase 2 (LMP2)ELISA Kit	96 Test	38220090	24,500.00
CLS3117HU	Human Hydrogen Voltage Gated Channel Protein 1 (HVCN1)ELISA Kit	96 Test	38220090	24,500.00
CLS3118HU	Human Proline/Serine Rich Coiled Coil protein 1 (PSRC1)ELISA Kit	96 Test	38220090	24,500.00
CLS3119HU	Human Carboxypeptidase N1 (CPN1)ELISA Kit	96 Test	38220090	24,500.00
CLS3120HU	Human Carboxypeptidase N2 (CPN2)ELISA Kit	96 Test	38220090	24,500.00
CLS3121HU	Human copine III (CPNE3)ELISA Kit	96 Test	38220090	24,500.00
CLS3122HU	Human Copine IX (CPNE9)ELISA Kit	96 Test	38220090	24,500.00
CLS3123HU	Human Aldosterone Synthase (ALDOS)ELISA Kit	96 Test	38220090	24,500.00

Cat.No.	Product Description	Pack Size	HSN	Unit Price
CLS3124HU	Human Cadherin EGF LAG Seven Pass G-Type Receptor 2 (CELSR2)ELISA Kit	96 Test	38220090	24,500.00
CLS3125HU	Human Ephrin Type A Receptor 10 (EPHA10)ELISA Kit	96 Test	38220090	24,500.00
CLS3126HU	Human Ephrin Type A Receptor 3 (EPHA3)ELISA Kit	96 Test	38220090	24,500.00
CLS3127HU	Human Protein Tyrosine Phosphatase Non Receptor Type 11 (PTPN11)ELISA Kit	96 Test	38220090	24,500.00
CLS3128HU	Human Coronin 2A(CORO2A)ELISA Kit	96 Test	38220090	24,500.00
CLS3129HU	Human Coronin 1A(CORO1A)ELISA Kit	96 Test	38220090	24,500.00
CLS3130HU	Human Coronin 2B(CORO2B)ELISA Kit	96 Test	38220090	24,500.00
CLS3131HU	Human Coronin 1C(CORO1C)ELISA Kit	96 Test	38220090	24,500.00
CLS3132HU	Human Coronin 6(CORO6)ELISA Kit	96 Test	38220090	24,500.00
CLS3133HU	Human Coronin 7(CORO7)ELISA Kit	96 Test	38220090	24,500.00
CLS3134HU	Human Branched Chain Alpha-Ketoacid Dehydrogenase Kinase (BCKDK)ELISA Kit	96 Test	38220090	24,500.00
CLS3135HU	Human Growth Arrest And DNA Damage Inducible Protein Alpha (GADD45a)ELISA Kit	96 Test	38220090	24,500.00
CLS3136HU	Human Adenylate Cyclase 5, Brain (ADCY5)ELISA Kit	96 Test	38220090	24,500.00
CLS3137HU	Human Vaccinia Related Kinase 1 (VRK1)ELISA Kit	96 Test	38220090	24,500.00
CLS3138HU	Human Tumor Protein, Translationally Controlled 1 (TPT1)ELISA Kit	96 Test	38220090	24,500.00
CLS3139HU	Human Adenylate Cyclase 10, Brain (ADCY10)ELISA Kit	96 Test	38220090	24,500.00
CLS3140HU	Human Deiodinase Iodothyronine Type I (DIO1)ELISA Kit	96 Test	38220090	24,500.00
CLS3141HU	Human Deiodinase Iodothyronine Type III (DIO3)ELISA Kit	96 Test	38220090	24,500.00
CLS3142HU	Human Complement Factor H Related Protein 3 (CFHR3)ELISA Kit	96 Test	38220090	24,500.00
CLS3143HU	Human Cleavage And Polyadenylation Specific Factor 1 (CPSF1)ELISA Kit	96 Test	38220090	24,500.00
CLS3144HU	Human Delta Like Protein 4 (dLL4)ELISA Kit	96 Test	38220090	24,500.00
CLS3145HU	Human Potassium Intermediate Small Conductance Calcium Activated Channel Subfamily N, Member 2 (KCN2)ELISA Kit	96 Test	38220090	24,500.00
CLS3146HU	Human CREB Regulated Transcription Coactivator 3 (CRTC3)ELISA Kit	96 Test	38220090	24,500.00
CLS3147HU	Human Coiled Coil Domain Containing Protein 3 (CCDC3)ELISA Kit	96 Test	38220090	24,500.00
CLS3148HU	Human Coiled Coil Domain Containing Protein 80 (CCDC80)ELISA Kit	96 Test	38220090	24,500.00
CLS3149HU	Human Dynein Heavy Chain Domain Containing Protein 1 (DNHD1)ELISA Kit	96 Test	38220090	24,500.00
CLS3150HU	Human Girdin (GRDN)ELISA Kit	96 Test	38220090	24,500.00
CLS3151HU	Human Pseudouridylate Synthase 10 (PUS10)ELISA Kit	96 Test	38220090	24,500.00
CLS3152HU	Human Protein Tyrosine Phosphatase Type IVA 3 (PTP4A3)ELISA Kit	96 Test	38220090	24,500.00
CLS3153HU	Human Protein Tyrosine Phosphatase Receptor Type K (PTPRK)ELISA Kit	96 Test	38220090	24,500.00
CLS3154HU	Human Protein Tyrosine Phosphatase Receptor Type R (PTPRR)ELISA Kit	96 Test	38220090	24,500.00
CLS3155HU	Human Protein Tyrosine Phosphatase Receptor Type N (PTPRN)ELISA Kit	96 Test	38220090	24,500.00
CLS3156HU	Human Protein Tyrosine Phosphatase Receptor Type B (PTPRB)ELISA Kit	96 Test	38220090	24,500.00
CLS3157HU	Human Protein Tyrosine Phosphatase Receptor Type O (PTPRO)ELISA Kit	96 Test	38220090	24,500.00
CLS3158HU	Human Zinc Ribbon Domain Containing Protein 1 (ZNRD1)ELISA Kit	96 Test	38220090	24,500.00
CLS3159HU	Human T-Cell, Immune Regulator 1 (TCIRG1)ELISA Kit	96 Test	38220090	24,500.00
CLS3160HU	Human TAO Kinase 1 (TAOK1)ELISA Kit	96 Test	38220090	24,500.00
CLS3161HU	Human TAO Kinase 2 (TAOK2)ELISA Kit	96 Test	38220090	24,500.00
CLS3162HU	Human TAO Kinase 3 (TAOK3)ELISA Kit	96 Test	38220090	24,500.00

Cat.No.	Product Description	Pack Size	HSN	Unit Price
CLS3163HU	Human Spindlin 2 (SPIN2)ELISA Kit	96 Test	38220090	24,500.00
CLS3164HU	Human Mitogen Activated Protein Kinase Kinase 6 (MAP3K6)ELISA Kit	96 Test	38220090	24,500.00
CLS3165HU	Human Mitogen Activated Protein Kinase Kinase 1 (MAP2K1)ELISA Kit	96 Test	38220090	24,500.00
CLS3166HU	Human Dual Specificity Phosphatase 9 (DUSP9)ELISA Kit	96 Test	38220090	24,500.00
CLS3167HU	Human Microtubule Associated Protein 1A (MAP1A)ELISA Kit	96 Test	38220090	24,500.00
CLS3168HU	Human Mitogen Activated Protein Kinase Kinase 1 (MAP3K1)ELISA Kit	96 Test	38220090	24,500.00
CLS3169HU	Human Mitogen Activated Protein Kinase Kinase Kinase 5 (MAP4K5)ELISA Kit	96 Test	38220090	24,500.00
CLS3170HU	Human Mitogen Activated Protein Kinase 14 (MAPK14)ELISA Kit	96 Test	38220090	24,500.00
CLS3171HU	Human Microtubule Associated Protein 4 (MAP4)ELISA Kit	96 Test	38220090	24,500.00
CLS3172HU	Human Mitogen Activated Protein Kinase Kinase 6 (MAP2K6)ELISA Kit	96 Test	38220090	24,500.00
CLS3173HU	Human Mitogen Activated Protein Kinase Scaffold Protein 1 (MAPKSP1)ELISA Kit	96 Test	38220090	24,500.00
CLS3174HU	Human Microtubule Associated Protein 6 (MAP6)ELISA Kit	96 Test	38220090	24,500.00
CLS3175HU	Human Stonin 1 (STON1)ELISA Kit	96 Test	38220090	24,500.00
CLS3176HU	Human Aryl Hydrocarbon Receptor Nuclear Translocator (ARNT)ELISA Kit	96 Test	38220090	24,500.00
CLS3177HU	Human Dual Specificity Phosphatase 6 (DUSP6)ELISA Kit	96 Test	38220090	24,500.00
CLS3178HU	Human Ganglioside M1(GM-1)ELISA Kit	96 Test	38220090	24,500.00
CLS3179HU	Human Anti-Ganglioside M1 Antibody (Anti-GM1)ELISA Kit	96 Test	38220090	24,500.00
CLS3180HU	Human Hexosaminidase A Alpha (HEXa)ELISA Kit	96 Test	38220090	24,500.00
CLS3181HU	Human Citron (CIT)ELISA Kit	96 Test	38220090	24,500.00
CLS3182HU	Human Chimerin 1 (CHN1)ELISA Kit	96 Test	38220090	24,500.00
CLS3183HU	Human Chimerin 2 (CHN2)ELISA Kit	96 Test	38220090	24,500.00
CLS3184HU	Human Rho GTPase 2 (RHPN2)ELISA Kit	96 Test	38220090	24,500.00
CLS3185HU	Human Rho GTPase 1 (RHPN1)ELISA Kit	96 Test	38220090	24,500.00
CLS3186HU	Human Centaurin Delta 1 (CENTd1)ELISA Kit	96 Test	38220090	24,500.00
CLS3187HU	Human Centaurin Delta 2 (CENTd2)ELISA Kit	96 Test	38220090	24,500.00
CLS3188HU	Human Centaurin Delta 3 (CENTd3)ELISA Kit	96 Test	38220090	24,500.00
CLS3189HU	Human Rho Guanine Nucleotide Exchange Factor 7 (ARHGEF7)ELISA Kit	96 Test	38220090	24,500.00
CLS3190HU	Human Rho GDP Dissociation Inhibitor Alpha (ARHGD1a)ELISA Kit	96 Test	38220090	24,500.00
CLS3191HU	Human Tripeptidyl Peptidase I (TPP1)ELISA Kit	96 Test	38220090	24,500.00
CLS3192HU	Human Proliferation Associated Protein 2G4 (PA2G4)ELISA kit	96 Test	38220090	24,500.00
CLS3193HU	Human Pallidin (PLDN)ELISA kit	96 Test	38220090	24,500.00
CLS3194HU	Human Phospholipase A2, Group IID (PLA2G2D)ELISA kit	96 Test	38220090	24,500.00
CLS3195HU	Human Phospholipase A2, Group X (PLA2G10)ELISA kit	96 Test	38220090	24,500.00
CLS3196HU	Human Phospholipase A2, Group IVD (PLA2G4D)ELISA kit	96 Test	38220090	24,500.00
CLS3197HU	Human Phospholipase A2, Group XIIB (PLA2G12B)ELISA kit	96 Test	38220090	24,500.00
CLS3198HU	Human Phospholipase A2, Pancreas (pPLA2)ELISA kit	96 Test	38220090	24,500.00
CLS3199HU	Human Phospholipase A2 Activating Protein (PLAA)ELISA kit	96 Test	38220090	24,500.00
CLS3200HU	Human Platelet Activating Factor Acetylhydrolase 2 (PAFAH2)ELISA kit	96 Test	38220090	24,500.00
CLS3201HU	Human Lipase H (LIPH)ELISA kit	96 Test	38220090	24,500.00
CLS3202HU	Human Lysophospholipase III (LYPLA3)ELISA kit	96 Test	38220090	24,500.00
CLS3203HU	Human Otoconin 90 (OC90)ELISA kit	96 Test	38220090	24,500.00
CLS3204HU	Human Semaphorin 6D (SEMA6D)ELISA Kit	96 Test	38220090	24,500.00

Cat.No.	Product Description	Pack Size	HSN	Unit Price
CLS3205HU	Human Sodium/Potassium/Calcium Exchanger 1 (NCKX1)ELISA Kit	96 Test	38220090	24,500.00
CLS3206HU	Human Sodium/Potassium/Calcium Exchanger 2 (NCKX2)ELISA Kit	96 Test	38220090	24,500.00
CLS3207HU	Human Sorting Nexin 11 (SNX11)ELISA Kit	96 Test	38220090	24,500.00
CLS3208HU	Human Sorting Nexin 12 (SNX12)ELISA Kit	96 Test	38220090	24,500.00
CLS3209HU	Human Sorting Nexin 15 (SNX15)ELISA Kit	96 Test	38220090	24,500.00
CLS3210HU	Human Sorting Nexin 19 (SNX19)ELISA Kit	96 Test	38220090	24,500.00
CLS3211HU	Human Sorting Nexin 2 (SNX2)ELISA Kit	96 Test	38220090	24,500.00
CLS3212HU	Human Sorting Nexin 3 (SNX3)ELISA Kit	96 Test	38220090	24,500.00
CLS3213HU	Human Sorting Nexin 4 (SNX4)ELISA Kit	96 Test	38220090	24,500.00
CLS3214HU	Human Sorting Nexin 5 (SNX5)ELISA Kit	96 Test	38220090	24,500.00
CLS3215HU	Human Sorting Nexin 6 (SNX6)ELISA Kit	96 Test	38220090	24,500.00
CLS3216HU	Human Sorting Nexin 7 (SNX7)ELISA Kit	96 Test	38220090	24,500.00
CLS3217HU	Human Sorting Nexin 8 (SNX8)ELISA Kit	96 Test	38220090	24,500.00
CLS3218HU	Human Sorting Nexin 9 (SNX9)ELISA Kit	96 Test	38220090	24,500.00
CLS3219HU	Human Sirtuin 4 (SIRT4)ELISA Kit	96 Test	38220090	24,500.00
CLS3220HU	Human Sirtuin 5 (SIRT5)ELISA Kit	96 Test	38220090	24,500.00
CLS3221HU	Human Six Transmembrane Epithelial Antigen Of The Prostate 2 (STEAP2)ELISA Kit	96 Test	38220090	24,500.00
CLS3222HU	Human Slit Homolog 1 (Slit1)ELISA Kit	96 Test	38220090	24,500.00
CLS3223HU	Human Slit Homolog 3 (Slit3)ELISA Kit	96 Test	38220090	24,500.00
CLS3224HU	Human Synaptotagmin II (SYT2)ELISA Kit	96 Test	38220090	24,500.00
CLS3225HU	Human Synaptotagmin III (SYT3)ELISA Kit	96 Test	38220090	24,500.00
CLS3226HU	Human Synaptotagmin IV (SYT4)ELISA Kit	96 Test	38220090	24,500.00
CLS3227HU	Human Synaptotagmin V (SYT5)ELISA Kit	96 Test	38220090	24,500.00
CLS3228HU	Human Synaptotagmin VI (SYT6)ELISA Kit	96 Test	38220090	24,500.00
CLS3229HU	Human Synaptotagmin VII (SYT7)ELISA Kit	96 Test	38220090	24,500.00
CLS3230HU	Human Synaptotagmin VIII (SYT8)ELISA Kit	96 Test	38220090	24,500.00
CLS3231HU	Human Synaptotagmin XI (SYT11)ELISA Kit	96 Test	38220090	24,500.00
CLS3232HU	Human Synaptotagmin XII (SYT12)ELISA Kit	96 Test	38220090	24,500.00
CLS3233HU	Human Synaptotagmin XIII (SYT13)ELISA Kit	96 Test	38220090	24,500.00
CLS3234HU	Human Synaptotagmin XIV (SYT14)ELISA Kit	96 Test	38220090	24,500.00
CLS3235HU	Human Synaptotagmin XVI (SYT16)ELISA Kit	96 Test	38220090	24,500.00
CLS3236HU	Human Syntaxin 10 (STX10)ELISA Kit	96 Test	38220090	24,500.00
CLS3237HU	Human Syntaxin 11 (STX11)ELISA Kit	96 Test	38220090	24,500.00
CLS3238HU	Human Syntaxin 12 (STX12)ELISA Kit	96 Test	38220090	24,500.00
CLS3239HU	Human Syntaxin 16 (STX16)ELISA Kit	96 Test	38220090	24,500.00
CLS3240HU	Human Syntaxin 17 (STX17)ELISA Kit	96 Test	38220090	24,500.00
CLS3241HU	Human Syntaxin 18 (STX18)ELISA Kit	96 Test	38220090	24,500.00
CLS3242HU	Human Syntaxin 1B (STX1B)ELISA Kit	96 Test	38220090	24,500.00
CLS3243HU	Human Syntaxin 4 (STX4)ELISA Kit	96 Test	38220090	24,500.00
CLS3244HU	Human Syntaxin 5 (STX5)ELISA Kit	96 Test	38220090	24,500.00
CLS3245HU	Human Syntaxin 6 (STX6)ELISA Kit	96 Test	38220090	24,500.00
CLS3246HU	Human Syntaxin 7 (STX7)ELISA Kit	96 Test	38220090	24,500.00
CLS3247HU	Human Syntaxin 8 (STX8)ELISA Kit	96 Test	38220090	24,500.00
CLS3248HU	Human T-Box Protein 1 (TBX1)ELISA Kit	96 Test	38220090	24,500.00
CLS3249HU	Human T-Box Protein 2 (TBX2)ELISA Kit	96 Test	38220090	24,500.00
CLS3250HU	Human T-Box Protein 3 (TBX3)ELISA Kit	96 Test	38220090	24,500.00
CLS3251HU	Human T-Box Protein 4 (TBX4)ELISA Kit	96 Test	38220090	24,500.00
CLS3252HU	Human T-Box Protein 5 (TBX5)ELISA Kit	96 Test	38220090	24,500.00
CLS3253HU	Human T-Box Protein 6 (TBX6)ELISA Kit	96 Test	38220090	24,500.00
CLS3254HU	Human Tektin 1 (TEKT1)ELISA Kit	96 Test	38220090	24,500.00
CLS3255HU	Human Tektin 3 (TEKT3)ELISA Kit	96 Test	38220090	24,500.00
CLS3256HU	Human Tenascin M (TNM)ELISA Kit	96 Test	38220090	24,500.00
CLS3257HU	Human Tenascin M2 (TENM2)ELISA Kit	96 Test	38220090	24,500.00
CLS3258HU	Human Tenascin M3 (TENM3)ELISA Kit	96 Test	38220090	24,500.00
CLS3259HU	Human Tenascin M4 (TENM4)ELISA Kit	96 Test	38220090	24,500.00
CLS3260HU	Human Tescalcin (TSC)ELISA Kit	96 Test	38220090	24,500.00

Cat.No.	Product Description	Pack Size	HSN	Unit Price
CLS3261HU	Human Thyroid Hormone Receptor Alpha (THRa)ELISA Kit	96 Test	38220090	24,500.00
CLS3262HU	Human Thyroid Hormone Receptor Beta (THRb)ELISA Kit	96 Test	38220090	24,500.00
CLS3263HU	Human TNF Receptor Associated Factor 6 (TRAF6)ELISA Kit	96 Test	38220090	24,500.00
CLS3264HU	Human Torsin 1A (TOR1A)ELISA Kit	96 Test	38220090	24,500.00
CLS3265HU	Human Torsin 1B (TOR1B)ELISA Kit	96 Test	38220090	24,500.00
CLS3266HU	Human Torsin 3A (TOR3A)ELISA Kit	96 Test	38220090	24,500.00
CLS3267HU	Human Ubiquilin 1 (UBQLN1)ELISA Kit	96 Test	38220090	24,500.00
CLS3268HU	Human Ubiquilin 2 (UBQLN2)ELISA Kit	96 Test	38220090	24,500.00
CLS3269HU	Human Ubiquilin 3 (UBQLN3)ELISA Kit	96 Test	38220090	24,500.00
CLS3270HU	Human Ubiquilin 4 (UBQLN4)ELISA Kit	96 Test	38220090	24,500.00
CLS3271HU	Human Vitrin (VIT)ELISA Kit	96 Test	38220090	24,500.00
CLS3272HU	Human V-Jun Sarcoma Virus 17 Oncogene Homolog (JUN)ELISA Kit	96 Test	38220090	24,500.00
CLS3273HU	Human V-Myb Myeloblastosis Viral Oncogene Homolog (MYB)ELISA Kit	96 Test	38220090	24,500.00
CLS3274HU	Human V-Myc Myelocytomatosis Viral Oncogene Homolog (MYC)ELISA Kit	96 Test	38220090	24,500.00
CLS3275HU	Human V-Rel Reticuloendotheliosis Viral Oncogene Homolog A (RELA)ELISA Kit	96 Test	38220090	24,500.00
CLS3276HU	Human V-Yes-1 Yamaguchi Sarcoma Viral Related Oncogene Homolog (LYN)ELISA Kit	96 Test	38220090	24,500.00
CLS3277HU	Human Xylulokinase Homolog (XYLB)ELISA Kit	96 Test	38220090	24,500.00
CLS3278HU	Human Zonadhesin (ZAN)ELISA Kit	96 Test	38220090	24,500.00
CLS3279HU	Human Trichohyalin (TCHH)ELISA Kit	96 Test	38220090	24,500.00
CLS3280HU	Human Tropomodulin 1 (TMOD1)ELISA Kit	96 Test	38220090	24,500.00
CLS3281HU	Human Tropomodulin 2 (TMOD2)ELISA Kit	96 Test	38220090	24,500.00
CLS3282HU	Human Tropomodulin 3 (TMOD3)ELISA Kit	96 Test	38220090	24,500.00
CLS3283HU	Human Tropomodulin 4 (TMOD4)ELISA Kit	96 Test	38220090	24,500.00
CLS3284HU	Human Plexin A1 (PLXNA1)ELISA Kit	96 Test	38220090	24,500.00
CLS3285HU	Human Plexin A3 (PLXNA3)ELISA Kit	96 Test	38220090	24,500.00
CLS3286HU	Human Plexin A4 (PLXNA4)ELISA Kit	96 Test	38220090	24,500.00
CLS3287HU	Human Plexin B1 (PLXNB1)ELISA Kit	96 Test	38220090	24,500.00
CLS3288HU	Human Plexin B2 (PLXNB2)ELISA Kit	96 Test	38220090	24,500.00
CLS3289HU	Human Plexin B3 (PLXNB3)ELISA Kit	96 Test	38220090	24,500.00
CLS3290HU	Human Plexin C1 (PLXNC1)ELISA Kit	96 Test	38220090	24,500.00
CLS3291HU	Human Plexin D1 (PLXND1)ELISA Kit	96 Test	38220090	24,500.00
CLS3292HU	Human Phospholipase D2 (PLD2)ELISA Kit	96 Test	38220090	24,500.00
CLS3293HU	Human Phospholipase D5 (PLD5)ELISA Kit	96 Test	38220090	24,500.00
CLS3294HU	Human Phospholipase D6 (PLD6)ELISA Kit	96 Test	38220090	24,500.00
CLS3295HU	Human Desmocollin 1 (DSC1)ELISA Kit	96 Test	38220090	24,500.00
CLS3296HU	Human Desmocollin 2 (DSC2)ELISA Kit	96 Test	38220090	24,500.00
CLS3297HU	Human Desmocollin 3 (DSC3)ELISA Kit	96 Test	38220090	24,500.00
CLS3298HU	Human Desmoyokin (AHNAK)ELISA Kit	96 Test	38220090	24,500.00
CLS3299HU	Human Destrin (DSTN)ELISA Kit	96 Test	38220090	24,500.00
CLS3300HU	Human Diaphanous Homolog 1 (DIAPH1)ELISA Kit	96 Test	38220090	24,500.00
CLS3301HU	Human Disabled Homolog 1 (DAB1)ELISA Kit	96 Test	38220090	24,500.00
CLS3302HU	Human Discs, Large Homolog Associated Protein 5 (DLGAP5)ELISA Kit	96 Test	38220090	24,500.00
CLS3303HU	Human Dynactin 4 (DCTN4)ELISA Kit	96 Test	38220090	24,500.00
CLS3304HU	Human Dynactin 5 (DCTN5)ELISA Kit	96 Test	38220090	24,500.00
CLS3305HU	Human Dynactin 6 (DCTN6)ELISA Kit	96 Test	38220090	24,500.00
CLS3306HU	Human Dynein, Axonemal, Heavy Chain 11 (DNAH11)ELISA Kit	96 Test	38220090	24,500.00
CLS3307HU	Human Dynein, Cytoplasmic 1, Heavy Chain 1 (DYNC1H1)ELISA Kit	96 Test	38220090	24,500.00
CLS3308HU	Human Early Growth Response Protein 2 (EGR2)ELISA Kit	96 Test	38220090	24,500.00

Cat.No.	Product Description	Pack Size	HSN	Unit Price
CLS3309HU	Human Elastin Microfibril Interface Located Protein 2 (EMILIN2)ELISA Kit	96 Test	38220090	24,500.00
CLS3310HU	Human Electron Transferring Flavoprotein Dehydrogenase (ETFDH)ELISA Kit	96 Test	38220090	24,500.00
CLS3311HU	Human Elongation Protein 2 (ELP2)ELISA Kit	96 Test	38220090	24,500.00
CLS3312HU	Human Engrailed Homeobox Protein 2 (EN2)ELISA Kit	96 Test	38220090	24,500.00
CLS3313HU	Human Eomesodermin (EOMES)ELISA Kit	96 Test	38220090	24,500.00
CLS3314HU	Human Epidermal Growth Factor Receptor 2 (EGFR2)ELISA Kit	96 Test	38220090	24,500.00
CLS3315HU	Human Epigen (EPG)ELISA Kit	96 Test	38220090	24,500.00
CLS3316HU	Human Epiphycan (EPYC)ELISA Kit	96 Test	38220090	24,500.00
CLS3317HU	Human Epithelial Membrane Protein 3 (EMP3)ELISA Kit	96 Test	38220090	24,500.00
CLS3318HU	Human Epithelial Stromal Interaction 1, Breast (EPSTI1)ELISA Kit	96 Test	38220090	24,500.00
CLS3319HU	Human Epsin 1 (EPN1)ELISA Kit	96 Test	38220090	24,500.00
CLS3320HU	Human Epsin 2 (EPN2)ELISA Kit	96 Test	38220090	24,500.00
CLS3321HU	Human Epsin 3 (EPN3)ELISA Kit	96 Test	38220090	24,500.00
CLS3322HU	Human Espin (ESPN)ELISA Kit	96 Test	38220090	24,500.00
CLS3323HU	Human Eukaryotic Translation Initiation Factor 6 (EIF6)ELISA Kit	96 Test	38220090	24,500.00
CLS3324HU	Human Exophilin 5 (EXPH5)ELISA Kit	96 Test	38220090	24,500.00
CLS3325HU	Human Exoribonuclease 1 (ERI1)ELISA Kit	96 Test	38220090	24,500.00
CLS3326HU	Human Exoribonuclease 2 (ERI2)ELISA Kit	96 Test	38220090	24,500.00
CLS3327HU	Human Exoribonuclease 3 (ERI3)ELISA Kit	96 Test	38220090	24,500.00
CLS3328HU	Human Exosome Component 1 (EXOSC1)ELISA Kit	96 Test	38220090	24,500.00
CLS3329HU	Human Exosome Component 2 (EXOSC2)ELISA Kit	96 Test	38220090	24,500.00
CLS3330HU	Human Exosome Component 3 (EXOSC3)ELISA Kit	96 Test	38220090	24,500.00
CLS3331HU	Human Exosome Component 4 (EXOSC4)ELISA Kit	96 Test	38220090	24,500.00
CLS3332HU	Human Exosome Component 1 (EXOSC5)ELISA Kit	96 Test	38220090	24,500.00
CLS3333HU	Human Exostoses 1 (EXT1)ELISA Kit	96 Test	38220090	24,500.00
CLS3334HU	Human Exostoses 2 (EXT2)ELISA Kit	96 Test	38220090	24,500.00
CLS3335HU	Human Exportin 1 (XPO1)ELISA Kit	96 Test	38220090	24,500.00
CLS3336HU	Human Fascin 3 (FSCN3)ELISA Kit	96 Test	38220090	24,500.00
CLS3337HU	Human Fibroblast Growth Factor 3 (FGF3)ELISA Kit	96 Test	38220090	24,500.00
CLS3338HU	Human Fibrous Sheath Interacting Protein 1 (FSIP1)ELISA Kit	96 Test	38220090	24,500.00
CLS3339HU	Human Fidgetin (FIGN)ELISA Kit	96 Test	38220090	24,500.00
CLS3340HU	Human Fission 1 (FIS1)ELISA Kit	96 Test	38220090	24,500.00
CLS3341HU	Human Flightless I Homolog (FLII)ELISA Kit	96 Test	38220090	24,500.00
CLS3342HU	Human Follistatin Like Protein 1 (FSTL1)ELISA Kit	96 Test	38220090	24,500.00
CLS3343HU	Human G Antigen 1 (GAGE1)ELISA Kit	96 Test	38220090	24,500.00
CLS3344HU	Human G Protein Coupled Receptor 37 (GPR37)ELISA Kit	96 Test	38220090	24,500.00
CLS3345HU	Human Gametogenetin (GGN)ELISA Kit	96 Test	38220090	24,500.00
CLS3346HU	Human Gastrokine 2 (GKN2)ELISA Kit	96 Test	38220090	24,500.00
CLS3347HU	Human General Transcription Factor IIA, Polypeptide 1 (GTF2A1)ELISA Kit	96 Test	38220090	24,500.00
CLS3348HU	Human General Transcription Factor IIB (GTF2B)ELISA Kit	96 Test	38220090	24,500.00
CLS3349HU	Human General Transcription Factor IIF, Polypeptide 1 (GTF2F1)ELISA Kit	96 Test	38220090	24,500.00
CLS3350HU	Human General Transcription Factor IIH, Polypeptide 1 (GTF2H1)ELISA Kit	96 Test	38220090	24,500.00
CLS3351HU	Human Gephyrin (GPHN)ELISA Kit	96 Test	38220090	24,500.00
CLS3352HU	Human Gigaxonin (GAN)ELISA Kit	96 Test	38220090	24,500.00
CLS3353HU	Human Glutaredoxin (GLRX)ELISA Kit	96 Test	38220090	24,500.00
CLS3354HU	Human Glutaredoxin 2 (GLRX2)ELISA Kit	96 Test	38220090	24,500.00
CLS3355HU	Human Glutaredoxin 3 (GLRX3)ELISA Kit	96 Test	38220090	24,500.00
CLS3356HU	Human Glutaredoxin 5 (GLRX5)ELISA Kit	96 Test	38220090	24,500.00
CLS3357HU	Human Glycogenin 1 (GYG1)ELISA Kit	96 Test	38220090	24,500.00
CLS3358HU	Human Glycoprotein 2, Zymogen Granule Membrane (GP2)ELISA Kit	96 Test	38220090	24,500.00

Cat.No.	Product Description	Pack Size	HSN	Unit Price
CLS3359HU	Human Glycoprotein A33 (GPA33)ELISA Kit	96 Test	38220090	24,500.00
CLS3360HU	Human Glycosylphosphatidylinositol Anchored Molecule Like Protein (GML)ELISA Kit	96 Test	38220090	24,500.00
CLS3361HU	Human Golgi Glycoprotein 1 (GLG1)ELISA Kit	96 Test	38220090	24,500.00
CLS3362HU	Human Golgin A1 (GOLGA1)ELISA Kit	96 Test	38220090	24,500.00
CLS3363HU	Human Golgin A2 (GOLGA2)ELISA Kit	96 Test	38220090	24,500.00
CLS3364HU	Human Golgin A3 (GOLGA3)ELISA Kit	96 Test	38220090	24,500.00
CLS3365HU	Human Golgin A4 (GOLGA4)ELISA Kit	96 Test	38220090	24,500.00
CLS3366HU	Human Golgin A5 (GOLGA5)ELISA Kit	96 Test	38220090	24,500.00
CLS3367HU	Human Golgin A6 (GOLGA6)ELISA Kit	96 Test	38220090	24,500.00
CLS3368HU	Human Golgin A7 (GOLGA7)ELISA Kit	96 Test	38220090	24,500.00
CLS3369HU	Human Golgin B1 (GOLGB1)ELISA Kit	96 Test	38220090	24,500.00
CLS3370HU	Human Goosecoid (GSC)ELISA Kit	96 Test	38220090	24,500.00
CLS3371HU	Human Goosecoid 2 (GSC2)ELISA Kit	96 Test	38220090	24,500.00
CLS3372HU	Human Gremlin 2 (GREM2)ELISA Kit	96 Test	38220090	24,500.00
CLS3373HU	Human Guanylate Cyclase Activator 2A (GUCA2A)ELISA Kit	96 Test	38220090	24,500.00
CLS3374HU	Human Guanylate Cyclase Activator 2B (GUCA2B)ELISA Kit	96 Test	38220090	24,500.00
CLS3375HU	Human Haponin ELISA Kit	96 Test	38220090	24,500.00
CLS3376HU	Human Hemogen (HEMGN)ELISA Kit	96 Test	38220090	24,500.00
CLS3377HU	Human Hepatocellular Carcinoma Related Protein 1 (HCRP1)ELISA Kit	96 Test	38220090	24,500.00
CLS3378HU	Human Hephaestin (HEPH)ELISA Kit	96 Test	38220090	24,500.00
CLS3379HU	Human Heterochromatin Protein 1 (HP1)ELISA Kit	96 Test	38220090	24,500.00
CLS3380HU	Human Hornerin (HRNR)ELISA Kit	96 Test	38220090	24,500.00
CLS3381HU	Human HtrA Serine Peptidase 2 (HTRA2)ELISA Kit	96 Test	38220090	24,500.00
CLS3382HU	Human Huntingtin (HTT)ELISA Kit	96 Test	38220090	24,500.00
CLS3383HU	Human Hyaluronoglucosaminidase 2 (HYAL2)ELISA Kit	96 Test	38220090	24,500.00
CLS3384HU	Human Ichthyin (ICHYN)ELISA Kit	96 Test	38220090	24,500.00
CLS3385HU	Human Immunoglobulin Lambda (Igl)ELISA Kit	96 Test	38220090	24,500.00
CLS3386HU	Human Inter Alpha-Globulin Inhibitor H2 (ITIH2)ELISA Kit	96 Test	38220090	24,500.00
CLS3387HU	Human Inter Alpha-Globulin Inhibitor H3 (ITIH3)ELISA Kit	96 Test	38220090	24,500.00
CLS3388HU	Human Inter Alpha-Globulin Inhibitor H5 (ITIH5)ELISA Kit	96 Test	38220090	24,500.00
CLS3389HU	Human Interferon Regulatory Factor 9 (IRF9)ELISA Kit	96 Test	38220090	24,500.00
CLS3390HU	Human Interleukin 1 Delta (IL1d)ELISA Kit	96 Test	38220090	24,500.00
CLS3391HU	Human Interleukin 1 Receptor Accessory Protein Like Protein 2 (IL1RAPL2)ELISA Kit	96 Test	38220090	24,500.00
CLS3392HU	Human Interleukin 18 Binding Protein (IL18BP)ELISA Kit	96 Test	38220090	24,500.00
CLS3393HU	Human Internexin Neuronal Intermediate Filament Protein Alpha (INa)ELISA Kit	96 Test	38220090	24,500.00
CLS3394HU	Human Junctional Adhesion Molecule 1 (JAM1)ELISA Kit	96 Test	38220090	24,500.00
CLS3395HU	Human Junctional Adhesion Molecule 3 (JAM3)ELISA Kit	96 Test	38220090	24,500.00
CLS3396HU	Human K-Acetyltransferase 2A (KAT2A)ELISA Kit	96 Test	38220090	24,500.00
CLS3397HU	Human Kalirin (KALRN)ELISA Kit	96 Test	38220090	24,500.00
CLS3398HU	Human Kaptin (KPTN)ELISA Kit	96 Test	38220090	24,500.00
CLS3399HU	Human Kindlin 1 (KIND1)ELISA Kit	96 Test	38220090	24,500.00
CLS3400HU	Human Kindlin 2 (KIND2)ELISA Kit	96 Test	38220090	24,500.00
CLS3401HU	Human Kindlin 3 (KIND3)ELISA Kit	96 Test	38220090	24,500.00
CLS3402HU	Human Kinesin Family, Member 14 (KIF14)ELISA Kit	96 Test	38220090	24,500.00
CLS3403HU	Human Kinesin Family, Member 1A (KIF1A)ELISA Kit	96 Test	38220090	24,500.00
CLS3404HU	Human Kinesin Family, Member 20A (KIF20A)ELISA Kit	96 Test	38220090	24,500.00
CLS3405HU	Human Kinesin Family, Member 5A (KIF5A)ELISA Kit	96 Test	38220090	24,500.00
CLS3406HU	Human Layilin (LAYN)ELISA Kit	96 Test	38220090	24,500.00
CLS3407HU	Human Leiomodin 2 (LMOD2)ELISA Kit	96 Test	38220090	24,500.00
CLS3408HU	Human Leiomodin 3 (LMOD3)ELISA Kit	96 Test	38220090	24,500.00
CLS3409HU	Human Leprecan Like Protein 1 (LEPREL1)ELISA Kit	96 Test	38220090	24,500.00
CLS3410HU	Human Lin-28 Homolog A (LIN28A)ELISA Kit	96 Test	38220090	24,500.00
CLS3411HU	Human Lipase, Monoacylglycerol (MGL)ELISA Kit	96 Test	38220090	24,500.00

Cat.No.	Product Description	Pack Size	HSN	Unit Price
CLS3412HU	Human Lipocalin 10 (LCN10)ELISA Kit	96 Test	38220090	24,500.00
CLS3413HU	Human Lipocalin 12 (LCN12)ELISA Kit	96 Test	38220090	24,500.00
CLS3414HU	Human Lipocalin 15 (LCN15)ELISA Kit	96 Test	38220090	24,500.00
CLS3415HU	Human Lipocalin 8 (LCN8)ELISA Kit	96 Test	38220090	24,500.00
CLS3416HU	Human Cornulin (CRNN)ELISA Kit	96 Test	38220090	24,500.00
CLS3417HU	Human Crystallin Lambda 1 (CRY1)ELISA Kit	96 Test	38220090	24,500.00
CLS3418HU	Human Cupidin (CPD)ELISA Kit	96 Test	38220090	24,500.00
CLS3419HU	Human Cylicin 1 (CYLC1)ELISA Kit	96 Test	38220090	24,500.00
CLS3420HU	Human Cylicin 2 (CYLC2)ELISA Kit	96 Test	38220090	24,500.00
CLS3421HU	Human Cystatin 11 (CST11)ELISA Kit	96 Test	38220090	24,500.00
CLS3422HU	Human Cystatin 2 (CST2)ELISA Kit	96 Test	38220090	24,500.00
CLS3423HU	Human Cystatin 5 (CST5)ELISA Kit	96 Test	38220090	24,500.00
CLS3424HU	Human Cystatin 6 (CST6)ELISA Kit	96 Test	38220090	24,500.00
CLS3425HU	Human Cystatin 7 (CST7)ELISA Kit	96 Test	38220090	24,500.00
CLS3426HU	Human Cystatin 8 (CST8)ELISA Kit	96 Test	38220090	24,500.00
CLS3427HU	Human Cystatin B (CSTB)ELISA Kit	96 Test	38220090	24,500.00
CLS3428HU	Human A Disintegrin And Metalloprotease 15 (ADAM15)ELISA Kit	96 Test	38220090	24,500.00
CLS3429HU	Human A Disintegrin And Metalloprotease 19 (ADAM19)ELISA Kit	96 Test	38220090	24,500.00
CLS3430HU	Human A Disintegrin And Metalloprotease 22 (ADAM22)ELISA Kit	96 Test	38220090	24,500.00
CLS3431HU	Human Acetylcholinesterase Associated Protein (ACHAP)ELISA Kit	96 Test	38220090	24,500.00
CLS3432HU	Human Activity Dependent Neuroprotector Protein (ADNP)ELISA Kit	96 Test	38220090	24,500.00
CLS3433HU	Human Adenylate Cyclase Activating Polypeptide 1, Pituitary (ADCYAP1)ELISA Kit	96 Test	38220090	24,500.00
CLS3434HU	Human Advillin (AVIL)ELISA Kit	96 Test	38220090	24,500.00
CLS3435HU	Human AE Binding Protein 1 (AEBP1)ELISA Kit	96 Test	38220090	24,500.00
CLS3436HU	Human Aftiphilin (AFTPH)ELISA Kit	96 Test	38220090	24,500.00
CLS3437HU	Human Ajuba (JUB)ELISA Kit	96 Test	38220090	24,500.00
CLS3438HU	Human Ameloblastin (AMBN)ELISA Kit	96 Test	38220090	24,500.00
CLS3439HU	Human Amelogenin Linked-Y (AMELY)ELISA Kit	96 Test	38220090	24,500.00
CLS3440HU	Amyloid Beta Precursor Like Protein 2 (APLP2)	96 Test	38220090	24,500.00
CLS3441HU	Human Ankyrin Repeat Domain Protein 1 (ANKRD1)ELISA Kit 1261	96 Test	38220090	24,500.00
CLS3442HU	Human Archaemetzincin 1 (AMZ1)ELISA Kit	96 Test	38220090	24,500.00
CLS3443HU	Human Astacin Like Metallo Endopeptidase (ASTL)ELISA Kit	96 Test	38220090	24,500.00
CLS3444HU	Human Astrotactin 1 (ASTN1)ELISA Kit	96 Test	38220090	24,500.00
CLS3445HU	Human Ataxia Cayman (ATCAY)ELISA Kit	96 Test	38220090	24,500.00
CLS3446HU	Human Atonal Homolog 1 (ATOH1)ELISA Kit	96 Test	38220090	24,500.00
CLS3447HU	Human Barttin (BART)ELISA Kit	96 Test	38220090	24,500.00
CLS3448HU	Human Battenin (BTS)ELISA Kit	96 Test	38220090	24,500.00
CLS3449HU	Human Beclin-1-Associated Autophagy Related Key Regulator (Barkor)ELISA Kit	96 Test	38220090	24,500.00
CLS3450HU	Human Biliverdin Reductase A (BLVRA)ELISA Kit	96 Test	38220090	24,500.00
CLS3451HU	Human Biliverdin Reductase B (BLVRB)ELISA Kit	96 Test	38220090	24,500.00
CLS3452HU	Human B-Melanoma Antigen (BAGE)ELISA Kit	96 Test	38220090	24,500.00
CLS3453HU	Human Brain Abundant, Membrane Attached Signal Protein 1 (BASP1)ELISA Kit	96 Test	38220090	24,500.00
CLS3454HU	Human Breast Cancer Anti Estrogen Resistance 1 (BCAR1)ELISA Kit	96 Test	38220090	24,500.00
CLS3455HU	Human Bridging Integrator 1 (BIN1)ELISA Kit	96 Test	38220090	24,500.00
CLS3456HU	Human Bridging Integrator 2 (BIN2)ELISA Kit	96 Test	38220090	24,500.00
CLS3457HU	Human Bridging Integrator 3 (BIN3)ELISA Kit	96 Test	38220090	24,500.00
CLS3458HU	Human BTG3 Associated Nuclear Protein (BANP)ELISA Kit	96 Test	38220090	24,500.00
CLS3459HU	Human Cadherin 10 (CDH10)ELISA Kit	96 Test	38220090	24,500.00

Cat.No.	Product Description	Pack Size	HSN	Unit Price
CLS3460HU	Human Cadherin 18 (CDH18)ELISA Kit	96 Test	38220090	24,500.00
CLS3461HU	Human Cadherin 19 (CDH19)ELISA Kit	96 Test	38220090	24,500.00
CLS3462HU	Human Cadherin 20 (CDH20)ELISA Kit	96 Test	38220090	24,500.00
CLS3463HU	Human Cadherin 22 (CDH22)ELISA Kit	96 Test	38220090	24,500.00
CLS3464HU	Human Cadherin 23 (CDH23)ELISA Kit	96 Test	38220090	24,500.00
CLS3465HU	Human Cadherin 7 (CDH7)ELISA Kit	96 Test	38220090	24,500.00
CLS3466HU	Human Cadherin 8 (CDH8)ELISA Kit	96 Test	38220090	24,500.00
CLS3467HU	Human Cadherin 9 (CDH9)ELISA Kit	96 Test	38220090	24,500.00
CLS3468HU	Human Calicin (CCIN)ELISA Kit	96 Test	38220090	24,500.00
CLS3469HU	Human Cancer Antigen 1 (CAGE1)ELISA Kit	96 Test	38220090	24,500.00
CLS3470HU	Human Cancer/Testis Antigen 2 (CTAG2)ELISA Kit	96 Test	38220090	24,500.00
CLS3471HU	Human Carbohydrate Sulfotransferase 1 (CHST1)ELISA Kit	96 Test	38220090	24,500.00
CLS3472HU	Human Carbohydrate Sulfotransferase 10 (CHST10)ELISA Kit	96 Test	38220090	24,500.00
CLS3473HU	Human Carbohydrate Sulfotransferase 11 (CHST11)ELISA Kit	96 Test	38220090	24,500.00
CLS3474HU	Human Carbohydrate Sulfotransferase 12 (CHST12)ELISA Kit	96 Test	38220090	24,500.00
CLS3475HU	Human Carbohydrate Sulfotransferase 13 (CHST13)ELISA Kit	96 Test	38220090	24,500.00
CLS3476HU	Human Carbohydrate Sulfotransferase 14 (CHST14)ELISA Kit	96 Test	38220090	24,500.00
CLS3477HU	Human Carbohydrate Sulfotransferase 15 (CHST15)ELISA Kit	96 Test	38220090	24,500.00
CLS3478HU	Human Carbohydrate Sulfotransferase 3 (CHST3)ELISA Kit	96 Test	38220090	24,500.00
CLS3479HU	Human Carbohydrate Sulfotransferase 4 (CHST4)ELISA Kit	96 Test	38220090	24,500.00
CLS3480HU	Human Carbohydrate Sulfotransferase 5 (CHST5)ELISA Kit	96 Test	38220090	24,500.00
CLS3481HU	Human Carbohydrate Sulfotransferase 7 (CHST7)ELISA Kit	96 Test	38220090	24,500.00
CLS3482HU	Human Carbohydrate Sulfotransferase 8 (CHST8)ELISA Kit	96 Test	38220090	24,500.00
CLS3483HU	Human Carbohydrate Sulfotransferase 9 (CHST9)ELISA Kit	96 Test	38220090	24,500.00
CLS3484HU	Human Casein Alpha (CSN1)ELISA Kit	96 Test	38220090	24,500.00
CLS3485HU	Human Casein Beta (CSN2)ELISA Kit	96 Test	38220090	24,500.00
CLS3486HU	Human Casein Kappa (CSN3)ELISA Kit	96 Test	38220090	24,500.00
CLS3487HU	Human Contractin Beta (CTRN2)ELISA Kit	96 Test	38220090	24,500.00
CLS3488HU	Human Centrobin (CNTROB)ELISA Kit	96 Test	38220090	24,500.00
CLS3489HU	Human Centromere Protein E (CENPE)ELISA Kit	96 Test	38220090	24,500.00
CLS3490HU	Human Centromere Protein I (CENPI)ELISA Kit	96 Test	38220090	24,500.00
CLS3491HU	Human Cerberus (CER)ELISA Kit	96 Test	38220090	24,500.00
CLS3492HU	Human Chitinase 3 Like Protein 2 (CHI3L2)ELISA Kit	96 Test	38220090	24,500.00
CLS3493HU	Human Chromobox Homolog 1 (CBX1)ELISA Kit	96 Test	38220090	24,500.00
CLS3494HU	Human Chromobox Homolog 2 (CBX2)ELISA Kit	96 Test	38220090	24,500.00
CLS3495HU	Human Chromobox Homolog 3 (CBX3)ELISA Kit	96 Test	38220090	24,500.00
CLS3496HU	Human Cingulin (CGN)ELISA Kit	96 Test	38220090	24,500.00
CLS3497HU	Human Clarin 1 (CLRN1)ELISA Kit	96 Test	38220090	24,500.00
CLS3498HU	Human Claspin (CLSPN)ELISA Kit	96 Test	38220090	24,500.00
CLS3499HU	Human Clock Homolog (CLOCK)ELISA Kit	96 Test	38220090	24,500.00
CLS3500HU	Human Coactivator Activator (COAA)ELISA Kit	96 Test	38220090	24,500.00

Cat.No.	Product Description	Pack Size	HSN	Unit Price
CLS3501HU	Human Coactosin Like Protein 1 (COTL1)ELISA Kit	96 Test	38220090	24,500.00
CLS3502HU	Human Cold Shock Domain Containing Protein E1, RNA Binding (CSDE1)ELISA Kit	96 Test	38220090	24,500.00
CLS3503HU	Human Copine II (CPNE2)ELISA Kit	96 Test	38220090	24,500.00
CLS3504HU	Human Copine IV (CPNE4)ELISA Kit	96 Test	38220090	24,500.00
CLS3505HU	Human Copine V (CPNE5)ELISA Kit	96 Test	38220090	24,500.00
CLS3506HU	Human Copine VII (CPNE7)ELISA Kit	96 Test	38220090	24,500.00
CLS3507HU	Human M-Phase Phosphoprotein 10 (MPHOSPH10)ELISA Kit	96 Test	38220090	24,500.00
CLS3508HU	Human M-Phase Phosphoprotein 6 (MPHOSPH6)ELISA Kit	96 Test	38220090	24,500.00
CLS3509HU	Human M-Phase Phosphoprotein 8 (MPHOSPH8)ELISA Kit	96 Test	38220090	24,500.00
CLS3510HU	Human M-Phase Phosphoprotein 9 (MPHOSPH9)ELISA Kit	96 Test	38220090	24,500.00
CLS3511HU	Human Mucolipin 1 (MCOLN1)ELISA Kit	96 Test	38220090	24,500.00
CLS3512HU	Human Mucolipin 2 (MCOLN2)ELISA Kit	96 Test	38220090	24,500.00
CLS3513HU	Human Mucolipin 3 (MCOLN3)ELISA Kit	96 Test	38220090	24,500.00
CLS3514HU	Human Neurogenic Differentiation 1 (NEUROD1)ELISA Kit	96 Test	38220090	24,500.00
CLS3515HU	Human Neurogenic Differentiation 2 (NEUROD2)ELISA Kit	96 Test	38220090	24,500.00
CLS3516HU	Human Neurogenic Differentiation 4 (NEUROD4)ELISA Kit	96 Test	38220090	24,500.00
CLS3517HU	Human Neurogenic Differentiation 6 (NEUROD6)ELISA Kit	96 Test	38220090	24,500.00
CLS3518HU	Human Peroxiredoxin 4 (PRDX4)ELISA Kit	96 Test	38220090	24,500.00
CLS3519HU	Human Peroxiredoxin 5 (PRDX5)ELISA Kit	96 Test	38220090	24,500.00
CLS3520HU	Human Secretoglobulin Family 2A, Member 2 (SCGB2A2)ELISA Kit	96 Test	38220090	24,500.00
CLS3521HU	Human RNA Binding Motif Protein 20 (RBM20)ELISA Kit	96 Test	38220090	24,500.00
CLS3522HU	Human RNA Binding Motif Protein 24 (RBM24)ELISA Kit	96 Test	38220090	24,500.00
CLS3523HU	Human RNA Binding Motif Protein 38 (RBM38)ELISA Kit	96 Test	38220090	24,500.00
CLS3524HU	Human Retbindin (RTBDN)ELISA Kit	96 Test	38220090	24,500.00
CLS3525HU	Human Reticulocalbin 2 (RCN2)ELISA Kit	96 Test	38220090	24,500.00
CLS3526HU	Human Parvalbumin (PVALB)ELISA Kit	96 Test	38220090	24,500.00
CLS3527HU	Human MutY Homolog (MUTYH)ELISA Kit	96 Test	38220090	24,500.00
CLS3528HU	Human Myogenic Factor 5 (MYF5)ELISA Kit	96 Test	38220090	24,500.00
CLS3529HU	Human Myogenic Factor 6 (MYF6)ELISA Kit	96 Test	38220090	24,500.00
CLS3530HU	Microtubule Associated Protein RP/EB Family, Member 1 (MAPRE1)ELISA Kit	96 Test	38220090	24,500.00
CLS3531HU	Human Calponin 1, Basic (CNN1)ELISA Kit	96 Test	38220090	24,500.00
CLS3532HU	Human Calponin 2 (CNN2)ELISA Kit	96 Test	38220090	24,500.00
CLS3533HU	Human Calreticulin 3 (CALR3)ELISA Kit	96 Test	38220090	24,500.00
CLS3534HU	Human Cystin 1 (CYS1)ELISA Kit	96 Test	38220090	24,500.00
CLS3535HU	Human Dachous 1 (DCHS1)ELISA Kit	96 Test	38220090	24,500.00
CLS3536HU	Human Dachous 2 (DCHS2)ELISA Kit	96 Test	38220090	24,500.00
CLS3537HU	Human Deleted In Malignant Brain Tumors 1 (DMBT1)ELISA Kit	96 Test	38220090	24,500.00
CLS3538HU	Human Striatin (STRN)ELISA Kit	96 Test	38220090	24,500.00
CLS3539HU	Human Stromal Antigen 1 (STAG1)ELISA Kit	96 Test	38220090	24,500.00
CLS3540HU	Human Stromal Antigen 2 (STAG2)ELISA Kit	96 Test	38220090	24,500.00
CLS3541HU	Human Stromal Antigen 3 (STAG3)ELISA Kit	96 Test	38220090	24,500.00
CLS3542HU	Human Suprabasin (SBSN)ELISA Kit	96 Test	38220090	24,500.00
CLS3543HU	Human Surfeit 2 (SURF2)ELISA Kit	96 Test	38220090	24,500.00
CLS3544HU	Human Surfeit 3 (SURF3)ELISA Kit	96 Test	38220090	24,500.00
CLS3545HU	Human Surfeit 4 (SURF4)ELISA Kit	96 Test	38220090	24,500.00
CLS3546HU	Human Surfeit 6 (SURF6)ELISA Kit	96 Test	38220090	24,500.00
CLS3547HU	Human Synaptogyrin 2 (SYNGR2)ELISA Kit	96 Test	38220090	24,500.00

Cat.No.	Product Description	Pack Size	HSN	Unit Price
CLS3548HU	Human Synaptogyrin 3 (SYNGR3)ELISA Kit	96 Test	38220090	24,500.00
CLS3549HU	Human Synaptogyrin 4 (SYNGR4)ELISA Kit	96 Test	38220090	24,500.00
CLS3550HU	Human Esophageal Cancer Related Gene 4 (ECRG4) Elisa Kit	96 Test	38220090	24,500.00
CLS3551HU	Human Stem Cell Factor Receptor,SCFR/CD117/C-kit ELISA kit	96 Test	38220090	24,500.00
CLS3552HU	Human Actin Alpha 1, Skeletal Muscle (ACTa1) ELISA Kit	96 Test	38220090	24,500.00
CLS3553HU	Human Keratin 2(KRT2)ELISA Kit	96 Test	38220090	24,500.00
CLS3554HU	Human non-neuronal enolase(NNE)ELISA Kit	96 Test	38220090	24,500.00
CLS3555HU	Human Interleukin 1 Receptor 2 (IL1R2) ELISA Kit	96 Test	38220090	24,500.00
CLS3556HU	Human Centromere Protein H(CENPH)ELISA Kit	96 Test	38220090	24,500.00
CLS3557HU	Human Adenylate Cyclase 9, Brain (ADCY9)ELISA Kit	96 Test	38220090	24,500.00
CLS3558HU	Human Adiponectin Receptor 1 (ADIPOR1) ELISA Kit	96 Test	38220090	24,500.00
CLS3559HU	Human Heremans Schmid Glycoprotein,Alpha 2,HSGa ELISA Kit	96 Test	38220090	24,500.00
CLS3560HU	Human Adenylate Cyclase 2, Brain (ADCY2)ELISA Kit	96 Test	38220090	24,500.00
CLS3561HU	Human Connexin 43 (CX43)ELISA kit	96 Test	38220090	24,500.00
CLS3562HU	Human Galectin 14 (GAL14) ELISA kit	96 Test	38220090	24,500.00
CLS3563HU	Human Galectin 9C (GAL9C) ELISA kit	96 Test	38220090	24,500.00
CLS3564HU	Human Galectin 1 (GAL1) ELISA kit	96 Test	38220090	24,500.00
CLS3565HU	Human Galectin 9B (GAL9B) ELISA kit	96 Test	38220090	24,500.00
CLS3566HU	Human Galectin 7B (GAL7B) ELISA kit	96 Test	38220090	24,500.00
CLS3567HU	Human Galectin 6 (GAL6) ELISA kit	96 Test	38220090	24,500.00
CLS3568HU	Human Galectin 4 (GAL4) ELISA kit	96 Test	38220090	24,500.00
CLS3569HU	Human Galectin 2 (GAL2) ELISA kit	96 Test	38220090	24,500.00
CLS3570HU	Human Galectin 12 (GAL12) ELISA kit	96 Test	38220090	24,500.00
CLS3571HU	Human Galectin 7 (GAL7) ELISA kit	96 Test	38220090	24,500.00
CLS3572HU	Human Macrophage Inflammatory Protein 1 Beta (MIP1b) ELISA Kit	96 Test	38220090	24,500.00
CLS3573HU	Human Insulin Like Growth Factor 2, Antisense (IGF2AS) ELISA kit	96 Test	38220090	24,500.00
CLS3574HU	Human Alpha-Hemoglobin Stabilizing Protein (aHSP)ELISA kit	96 Test	38220090	24,500.00
CLS3575HU	Human Gliomedin (GLDN)ELISA kit	96 Test	38220090	24,500.00
CLS3576HU	Human Heat Shock 70kDa Protein 1B (HSPA1B)ELISA kit	96 Test	38220090	24,500.00
CLS3577HU	Human DnaJ/HSP40 Homolog Subfamily C, Member 12 (DNAJC12)ELISA kit	96 Test	38220090	24,500.00
CLS3578HU	Human Heat Shock 70kDa Protein 8 (HSPA8)ELISA kit	96 Test	38220090	24,500.00
CLS3579HU	Human Heat Shock Protein 90kDa Beta 1 (HSP90b1)ELISA kit	96 Test	38220090	24,500.00
CLS3580HU	Human Heat Shock Protein 47 (HSP47)ELISA kit	96 Test	38220090	24,500.00
CLS3581HU	Human Hypoxia Up Regulated 1 (HYOU1)ELISA kit	96 Test	38220090	24,500.00
CLS3582HU	Human Heat Shock 70kDa Protein 4 (HSPA4)ELISA kit	96 Test	38220090	24,500.00
CLS3583HU	Human Heat Shock 70kDa Protein 9 (HSPA9)ELISA kit	96 Test	38220090	24,500.00
CLS3584HU	Human Period Circadian Protein 1 (PER1)ELISA kit	96 Test	38220090	24,500.00
CLS3585HU	Human Glypican 2 (GPC2)ELISA Kit	96 Test	38220090	24,500.00
CLS3586HU	Human Complement 2,C2 ELISA Kit	96 Test	38220090	24,500.00
CLS3587HU	Human Mesencephalic astrocyte-derived neurotrophic factor,MANF ELISA Kit	96 Test	38220090	24,500.00
CLS3588HU	Human Nuclear transcription factor kBp65 (NFkBp65) ELISA ELISA	96 Test	38220090	24,500.00
CLS3589HU	Human Follistatin-related protein 4(FSTL4)ELISA Kit	96 Test	38220090	24,500.00
CLS3590HU	Human Follistatin-related protein 5(FSTL5)ELISA Kit	96 Test	38220090	24,500.00
CLS3591HU	Human Tomoregulin-1(TMEFF1)ELISA Kit	96 Test	38220090	24,500.00
CLS3592HU	Human Tomoregulin-2(TMEFF2)ELISA Kit	96 Test	38220090	24,500.00
CLS3593HU	Human Hemoglobin subunit alpha(HBA1)ELISA Kit	96 Test	38220090	24,500.00
CLS3594HU	Human Alpha-type platelet-derived growth factor receptor,PDGFRA ELISA kit	96 Test	38220090	24,500.00

Cat.No.	Product Description	Pack Size	HSN	Unit Price
CLS3595HU	Human Platelet-derived growth factor C,PDGF-C ELISA kit	96 Test	38220090	24,500.00
CLS3596HU	Human ELL-associated factor 2(EAF2) ELISA Kit	96 Test	38220090	24,500.00
CLS3597HU	Human cytochrome P450 2D6,CYP2D6 ELISA Kit	96 Test	38220090	24,500.00
CLS3598HU	Human cytochrome P450 2B6,CYP2B6 ELISA Kit	96 Test	38220090	24,500.00
CLS3599HU	Human cytochrome P450 7A1,CYP7A1 ELISA Kit	96 Test	38220090	24,500.00
CLS3600HU	Human Steroid 17-alpha-hydroxylase/17,20 lyase;Cytochrome P450 17A1,CYP17A1 ELISA Kit	96 Test	38220090	24,500.00
CLS3601HU	Human Normetanephrine ,NMN ELISA Kit	96 Test	38220090	24,500.00
CLS3602HU	Human Zinc finger HIT domain-containing protein 3(ZNHIT3) ELISA Kit	96 Test	38220090	24,500.00
CLS3603HU	Human Zinc finger matrin-type protein 3(ZMAT3)ELISA Kit	96 Test	38220090	24,500.00
CLS3604HU	Human Glypican-5,GPC-5 ELISA Kit	96 Test	38220090	24,500.00
CLS3605HU	Human Glypican-6,GPC-6 ELISA Kit	96 Test	38220090	24,500.00
CLS3606HU	Human Carnosine Synthase 1 (CARNS1) ELISA Kit	96 Test	38220090	24,500.00
CLS3607HU	Human Vitamin B3,VB3 ELISA Kit	96 Test	38220090	24,500.00
CLS3608HU	Human G-protein coupled receptor 54(KISS-1 receptor) ELISA Kit	96 Test	38220090	24,500.00
CLS3609HU	Human Troponin T, slow skeletal muscle(TNNT1) ELISA Kit	96 Test	38220090	24,500.00
CLS3610HU	Human Troponin T, slow skeletal muscle(TNNT3) ELISA Kit	96 Test	38220090	24,500.00
CLS3611HU	Human Troponin I, fast skeletal muscle(TNNT2) ELISA Kit	96 Test	38220090	24,500.00
CLS3612HU	Human Neurofilament heavy polypeptide,NEFH ELISA Kit	96 Test	38220090	24,500.00
CLS3613HU	Human Sialidase-2,NEU2 ELISA Kit	96 Test	38220090	24,500.00
CLS3614HU	Human Sialidase-3,NEU3 ELISA Kit	96 Test	38220090	24,500.00
CLS3615HU	Human Sialidase-4,NEU4 ELISA Kit	96 Test	38220090	24,500.00
CLS3616HU	Human Beta-defensin 4,DEFB4 ELISA kit	96 Test	38220090	24,500.00
CLS3617HU	Human Defensin Beta 126 (DEFb126)ELISA Kit	96 Test	38220090	24,500.00
CLS3618HU	Human Defensin Beta 114 (DEFb114)ELISA Kit	96 Test	38220090	24,500.00
CLS3619HU	Human Defensin Beta 129 (DEFb129)ELISA Kit	96 Test	38220090	24,500.00
CLS3620HU	Human Dickkopf-like protein 1(DKKL1) ELISA Kit	96 Test	38220090	24,500.00
CLS3621HU	Human Endothelin-1 receptor,EDNRA ELISA Kit	96 Test	38220090	24,500.00
CLS3622HU	Human Ryanodine receptor 2,RyR2 ELISA kit	96 Test	38220090	24,500.00
CLS3623HU	Human Ryanodine receptor 3,RyR3 ELISA kit	96 Test	38220090	24,500.00
CLS3624HU	Human Hyaluronan synthase 3,HAS3 ELISA Kit	96 Test	38220090	24,500.00
CLS3625HU	Human Hyaluronan mediated motility receptor(HMMR) ELISA Kit	96 Test	38220090	24,500.00
CLS3626HU	Human Lymphatic vessel endothelial hyaluronic acid receptor 1(LYVE-1) ELISA Kit	96 Test	38220090	24,500.00
CLS3627HU	Human Thymidine kinase, cytosolic(TK1) ELISA Kit	96 Test	38220090	24,500.00
CLS3628HU	Human Acetyl-Coa Carboxylase1(ACC1) ELISA Kit	96 Test	38220090	24,500.00
CLS3629HU	Human Acetyl-Coa Carboxylase2(ACC2) ELISA Kit	96 Test	38220090	24,500.00
CLS3630HU	Human Atrial natriuretic peptide receptor 2,NPR2 ELISA kit	96 Test	38220090	24,500.00
CLS3631HU	Human Atrial natriuretic peptide receptor 1,NPR1 ELISA kit	96 Test	38220090	24,500.00
CLS3632HU	Human Atrial natriuretic peptide receptor 3,NPR3 ELISA kit	96 Test	38220090	24,500.00
CLS3633HU	Human Cytokine receptor-like factor 2,CRLF2 ELISA kit	96 Test	38220090	24,500.00
CLS3634HU	Human SPRY domain-containing SOCS box protein 1,SPSB1 ELISA kit	96 Test	38220090	24,500.00
CLS3635HU	Human SPRY domain-containing SOCS box protein 2,SPSB2 ELISA kit	96 Test	38220090	24,500.00
CLS3636HU	Human SPRY domain-containing SOCS box protein 3,SPSB3 ELISA kit	96 Test	38220090	24,500.00
CLS3637HU	Human SPRY domain-containing SOCS box protein 4,SPSB4 ELISA kit	96 Test	38220090	24,500.00

Cat.No.	Product Description	Pack Size	HSN	Unit Price
CLS3638HU	Human Non-histone chromosomal protein HMG-14,HMG14 ELISA kit	96 Test	38220090	24,500.00
CLS3639HU	Human Fructose-1,6-bisphosphatase 1,FBP1 ELISA kit	96 Test	38220090	24,500.00
CLS3640HU	Human Serum response factor-binding protein 1,SRFBP1 ELISA kit	96 Test	38220090	24,500.00
CLS3641HU	Human Pre-mRNA-processing factor 40 homolog A,PRPF40A ELISA kit	96 Test	38220090	24,500.00
CLS3642HU	Human Fibroblast growth factor-binding protein 1,FGFBP1 ELISA kit	96 Test	38220090	24,500.00
CLS3643HU	Human Polyamine-modulated factor 1-binding protein 1,PMFBP1 ELISA kit	96 Test	38220090	24,500.00
CLS3644HU	Human Formin-binding protein 1,FNBP1 ELISA kit	96 Test	38220090	24,500.00
CLS3645HU	Human Formin-binding protein 1-like,FNBP1L ELISA kit	96 Test	38220090	24,500.00
CLS3646HU	Human 6-phosphofructo-2-kinase/fructose-2,6-biphosphatase 1,PFKFB1 ELISA kit	96 Test	38220090	24,500.00
CLS3647HU	Human 6-phosphofructo-2-kinase/fructose-2,6-biphosphatase 2,PFKFB2 ELISA kit	96 Test	38220090	24,500.00
CLS3648HU	Human Glycogen phosphorylase,GP ELISA Kit	96 Test	38220090	24,500.00
CLS3649HU	Human Glycogen synthase,GYS/GYS1 ELISA Kit	96 Test	38220090	24,500.00
CLS3650HU	Human Glycogen synthase kinase-3 alpha,Gsk3a ELISA Kit	96 Test	38220090	24,500.00
CLS3651HU	Human Glycogen synthase kinase-3 beta,Gsk3b ELISA Kit	96 Test	38220090	24,500.00
CLS3652HU	Human Glycogen synthase 2,GYS2 ELISA Kit	96 Test	38220090	24,500.00
CLS3653HU	Human Tubulin polymerization-promoting protein,TPPP ELISA Kit	96 Test	38220090	24,500.00
CLS3654HU	Human Tubulin polymerization-promoting protein family member 2,TPPP2 ELISA Kit	96 Test	38220090	24,500.00
CLS3655HU	Human Tubulin polymerization-promoting protein family member 3,TPPP3 ELISA Kit	96 Test	38220090	24,500.00
CLS3656HU	Human Serine/threonine-protein kinase Nek3,NEK3 ELISA Kit	96 Test	38220090	24,500.00
CLS3657HU	Human Tripartite motif-containing protein 21,TRIM21/RNF81 ELISA Kit	96 Test	38220090	24,500.00
CLS3658HU	Human Gonadotropin-releasing hormone receptor,GnRHR ELISA Kit	96 Test	38220090	24,500.00
CLS3659HU	Human Protein jagged-2,JAG2 ELISA Kit	96 Test	38220090	24,500.00
CLS3660HU	Human Collagen type I alpha 2,COL1A2/Collagen I ELISA Kit	96 Test	38220090	24,500.00
CLS3661HU	Human Collagen alpha-1(IV) chain,COL4A1/Collagen IV ELISA Kit	96 Test	38220090	24,500.00
CLS3662HU	Human Deoxyribonuclease-1-like 1,DNASE1L1 ELISA Kit	96 Test	38220090	24,500.00
CLS3663HU	Human Cytochrome P450 1A1 (CYP1A1)ELISA kit	96 Test	38220090	24,500.00
CLS3664HU	Human Fructosamine-3-kinase,FN3K ELISA kit	96 Test	38220090	24,500.00
CLS3665HU	Human Rho Guanine Nucleotide Exchange Factor 1(ARHGEF1)ELISA Kit	96 Test	38220090	24,500.00
CLS3666HU	Human Rho Guanine Nucleotide Exchange Factor 2(ARHGEF2)ELISA Kit	96 Test	38220090	24,500.00
CLS3667HU	Human Rho Guanine Nucleotide Exchange Factor 3(ARHGEF3)ELISA Kit	96 Test	38220090	24,500.00
CLS3668HU	Human Rho Guanine Nucleotide Exchange Factor 4(ARHGEF4)ELISA Kit	96 Test	38220090	24,500.00
CLS3669HU	Human Rho Guanine Nucleotide Exchange Factor 5(ARHGEF5)ELISA Kit	96 Test	38220090	24,500.00
CLS3670HU	Human Rho Guanine Nucleotide Exchange Factor 6(ARHGEF6)ELISA Kit	96 Test	38220090	24,500.00
CLS3671HU	Human Cyclic AMP-dependent transcription factor ATF-2,ATF2 ELISA kit	96 Test	38220090	24,500.00
CLS3672HU	Human Cyclin-dependent kinase inhibitor 1,CDKN1A/P21 ELISA kit	96 Test	38220090	24,500.00
CLS3673HU	Human Selenide, water dikinase 1,SEPHS1 ELISA kit	96 Test	38220090	24,500.00

Cat.No.	Product Description	Pack Size	HSN	Unit Price
CLS3674HU	Human Selenide, water dikinase 2,SEPHS2 ELISA kit	96 Test	38220090	24,500.00
CLS3675HU	Human mitogen activated protein kinase3,MAPK3/PRKM3 ELISA Kit	96 Test	38220090	24,500.00
CLS3676HU	Human Nuclear receptor ROR-gamma(RORC) ELISA Kit	96 Test	38220090	24,500.00
CLS3677HU	Human Delta Like Protein 1(DLL1)ELISA Kit	96 Test	38220090	24,500.00
CLS3678HU	Human Delta Like Protein 3(DLL3)ELISA Kit	96 Test	38220090	24,500.00
CLS3679HU	Human Acetyl Coenzyme A carboxylase alpha,ACACA ELISA Kit	96 Test	38220090	24,500.00
CLS3680HU	Human Tyrosine-protein kinase receptor UFO,AXL/UFO ELISA Kit	96 Test	38220090	24,500.00
CLS3681HU	Human Aldo-keto reductase family 1 member C3(AKR1C3/DD3)ELISA Kit	96 Test	38220090	24,500.00
CLS3682HU	Human Fibrinogen-like protein 1,FGL1 ELISA Kit	96 Test	38220090	24,500.00
CLS3683HU	Human Annexin A6 (ANXA6)ELISA Kit	96 Test	38220090	24,500.00
CLS3684HU	Human Annexin A4 (ANXA4)ELISA Kit	96 Test	38220090	24,500.00
CLS3685HU	Human Immunoglobulin A1,IgA1 ELISA Kit	96 Test	38220090	24,500.00
CLS3686HU	Human Estradiol 17-beta-dehydrogenase 2,HSD17B2 ELISA Kit	96 Test	38220090	24,500.00
CLS3687HU	Human Estradiol 17-beta-dehydrogenase 11,HSD17B11 ELISA Kit	96 Test	38220090	24,500.00
CLS3688HU	Human Estradiol 17-beta-dehydrogenase 8,HSD17B8 ELISA Kit	96 Test	38220090	24,500.00
CLS3689HU	Human Estradiol 17-beta-dehydrogenase 4,HSD17B4 ELISA Kit	96 Test	38220090	24,500.00
CLS3690HU	Human Estradiol 17-beta-dehydrogenase 3,HSD17B3 ELISA Kit	96 Test	38220090	24,500.00
CLS3691HU	Human Estradiol 17-beta-dehydrogenase 12,HSD17B12 ELISA Kit	96 Test	38220090	24,500.00
CLS3692HU	Human interferon regulatory factor 2,IRF2 ELISA Kit	96 Test	38220090	24,500.00
CLS3693HU	Human interferon regulatory factor 4,IRF4 ELISA Kit	96 Test	38220090	24,500.00
CLS3694HU	Human interferon regulatory factor 5,IRF5 ELISA Kit	96 Test	38220090	24,500.00
CLS3695HU	Human interferon regulatory factor 6,IRF6 ELISA Kit	96 Test	38220090	24,500.00
CLS3696HU	Human interferon regulatory factor 7,IRF7 ELISA Kit	96 Test	38220090	24,500.00
CLS3697HU	Human Tumor necrosis factor receptor superfamily member 4,Tnfrsf4/Ox40 ELISA Kit	96 Test	38220090	24,500.00
CLS3698HU	Human Oxysterol Binding Protein-Like 1A,OSBPL1A ELISA Kit	96 Test	38220090	24,500.00
CLS3699HU	Human Oxysterol Binding Protein Like Protein 8,OSBPL8 ELISA Kit	96 Test	38220090	24,500.00
CLS3700HU	Human Platelet-Derived Growth Factor AA(PDGF-AA) ELISA Kit	96 Test	38220090	24,500.00
CLS3701HU	Human Hedgehog-interacting protein,HHIP ELISA Kit	96 Test	38220090	24,500.00
CLS3702HU	Human CART prepropeptide(CARTPT)ELISA Kit	96 Test	38220090	24,500.00
CLS3703HU	Human cartilage glycoprotein39,HCgp-39/YKL-40 ELISA Kit	96 Test	38220090	24,500.00
CLS3704HU	human Amphiregulin B (AREGB)ELISA Kit	96 Test	38220090	24,500.00
CLS0001RA	Rat Vascular Endothelial cell Growth Factor A,VEGF-A ELISA KIT	96 Test	38220090	24,500.00
CLS0002RA	Rat Protein Carbonyl,PC ELISA Kit	96 Test	38220090	24,500.00
CLS0003RA	Rat N-terminal pro-brain natriuretic peptide,NT-proBNP ELISA Kit	96 Test	38220090	24,500.00
CLS0004RA	Rat C1q/TNF-related protein-3(Cartonectin/CTRP3/CORS-26)ELISA Kit	96 Test	38220090	24,500.00
CLS0005RA	Rat CTX-Collagen type 3(col3)ELISA Kit	96 Test	38220090	24,500.00
CLS0006RA	Rat Insulin-like growth factor binding protein 1,IGFBP-1 ELISA Kit	96 Test	38220090	24,500.00
CLS0007RA	Rat Glycated Albumin(GA)ELISA Kit	96 Test	38220090	24,500.00
CLS0008RA	Rat Glutamate decarboxylase 1(GAD1)ELISA	96 Test	38220090	24,500.00
CLS0009RA	Rat Cyclosporine A(CsA)ELISA Kit	96 Test	38220090	24,500.00
CLS0010RA	Rat Interleukin 3,IL-3 ELISA KIT	96 Test	38220090	24,500.00

Cat.No.	Product Description	Pack Size	HSN	Unit Price
CLS0011RA	Rat macrophage inflammatory protein 1 α ,MIP-1 α ELISA Kit	96 Test	38220090	24,500.00
CLS0012RA	Rat gonadotropin-releasing hormone,GnRH ELISA Kit	96 Test	38220090	24,500.00
CLS0013RA	Rat Testosterone,T ELISA Kit	96 Test	38220090	24,500.00
CLS0014RA	Rat follicle-stimulating hormone,FSH ELISA Kit	96 Test	38220090	24,500.00
CLS0015RA	Rat Luteinizing Hormone,LH ELISA Kit	96 Test	38220090	24,500.00
CLS0016RA	Rat Transient receptor protein 6(TRPC6)ELISA Kit	96 Test	38220090	24,500.00
CLS0017RA	Rat cysteinyl aspartate specific proteinases 3,Caspase-3/ CPP32 ELISA Kit	96 Test	38220090	24,500.00
CLS0018RA	Rat 11-Beta-Hydroxysteroid Dehydrogenase Type 1 (11BHS1) ELISA Kit	96 Test	38220090	24,500.00
CLS0019RA	Rat Heat Shock Protein 72(HSP-72)ELISA Kit	96 Test	38220090	24,500.00
CLS0020RA	Rat Corticosterone,CORT ELISA Kit	96 Test	38220090	24,500.00
CLS0021RA	Rat ovarian cancer marker-CA125(CA125)ELISA Kit	96 Test	38220090	24,500.00
CLS0022RA	Rat Noradrenaline,NE ELISA Kit	96 Test	38220090	24,500.00
CLS0023RA	Rat prolactin,PRL ELISA Kit	96 Test	38220090	24,500.00
CLS0024RA	Rat low density lipoprotein receptor(LDLR)ELISA Kit	96 Test	38220090	24,500.00
CLS0025RA	Rat Hormone-sensitive lipase(LIPE)ELISA Kit	96 Test	38220090	24,500.00
CLS0026RA	Rat Hydroxymethylglutaryl CoA Reductase(HMG-CoAR)ELISA Kit	96 Test	38220090	24,500.00
CLS0027RA	Rat Lipase,Gastric(LIPF)ELISA Kit	96 Test	38220090	24,500.00
CLS0028RA	Rat C-Reactive Protein,CRP ELISA Kit	96 Test	38220090	24,500.00
CLS0029RA	Rat malondialdehyde,MDA ELISA Kit	96 Test	38220090	24,500.00
CLS0030RA	Rat Interleukin 1 β ,IL-1 β ELISA Kit	96 Test	38220090	24,500.00
CLS0031RA	Rat Interleukin 6,IL-6 ELISA KIT	96 Test	38220090	24,500.00
CLS0032RA	Rat Neuron-specific enolase,NSE ELISA Kit	96 Test	38220090	24,500.00
CLS0033RA	Rat Interleukin 18,IL-18 Elisa Kit	96 Test	38220090	24,500.00
CLS0034RA	Rat neuronal nitric oxide synthase,NOS, nNOS ELISA Kit	96 Test	38220090	24,500.00
CLS0035RA	Rat free fatty acids,FFA ELISA Kit	96 Test	38220090	24,500.00
CLS0036RA	Rat high sensitivity C-Reactive Protein,hs-CRP ELISA Kit	96 Test	38220090	24,500.00
CLS0037RA	Rat Insulin,INS ELISA Kit	96 Test	38220090	24,500.00
CLS0038RA	Rat uncoupling protein 1(UCP1)ELISA Kit	96 Test	38220090	24,500.00
CLS0039RA	Rat peroxisome proliferator-activated receptor γ coactivator-1,PGC-1 ELISA KIT	96 Test	38220090	24,500.00
CLS0040RA	Rat Prostaglandin E2,PG-E2 ELISA Kit	96 Test	38220090	24,500.00
CLS0041RA	Rat monocyte chemotactic protein 1,MCP-1 ELISA kit	96 Test	38220090	24,500.00
CLS0042RA	Rat Interleukin 22(IL-22)ELISA Kit	96 Test	38220090	24,500.00
CLS0043RA	Rat Interleukin 12,IL-12/P40 ELISA KIT	96 Test	38220090	24,500.00
CLS0044RA	Rat Soluble protein-100B,S-100B ELISA Kit	96 Test	38220090	24,500.00
CLS0045RA	Rat S100 calcium binding protein A4(S100A4)ELISA Kit	96 Test	38220090	24,500.00
CLS0046RA	Rat myeloperoxidase,MPO ELISA Kit	96 Test	38220090	24,500.00
CLS0047RA	Rat Thyroid Stimulating Hormone,TSH ELISA Kit	96 Test	38220090	24,500.00
CLS0048RA	Rat Neogenin 1(NEO1)ELISA Kit	96 Test	38220090	24,500.00
CLS0049RA	Rat matriptase-2(MT2)ELISA Kit	96 Test	38220090	24,500.00
CLS0050RA	Rat Bone morphogenetic protein 6,BMP-6 ELISA Kit	96 Test	38220090	24,500.00
CLS0051RA	Rat hemojuvelin(HJV)ELISA Kit	96 Test	38220090	24,500.00
CLS0052RA	Rat Defensin Beta 2(DEFb2)ELISA Kit	96 Test	38220090	24,500.00
CLS0053RA	Rat Immunoglobulin G,IgG ELISA Kit	96 Test	38220090	24,500.00
CLS0054RA	Rat Delta-aminolevulinic acid dehydratase,ALAD Elisa kit	96 Test	38220090	24,500.00
CLS0055RA	Rat oxalic acid(OA)ELISA Kit	96 Test	38220090	24,500.00
CLS0056RA	Rat matrix metalloproteinase 13,MMP-13 ELISA kit	96 Test	38220090	24,500.00
CLS0057RA	Rat glial cell line-derived neurotrophic factor,GDNF ELISA KIT	96 Test	38220090	24,500.00
CLS0058RA	Rat Dihydrotestosterone,DHT ELISA Kit	96 Test	38220090	24,500.00
CLS0059RA	Rat prostate specific antigen,PSA ELISA Kit	96 Test	38220090	24,500.00
CLS0060RA	Rat Endothelial cell-specific molecule 1,ESM-1 ELISA kit	96 Test	38220090	24,500.00
CLS0061RA	Rat 8-Hydroxy-desoxyguanosine,8-OHdG ELISA Kit	96 Test	38220090	24,500.00
CLS0062RA	Rat Mullerian Inhibiting Substance/Anti-Mullerian hormone,MIS/AMH ELISA Kit	96 Test	38220090	24,500.00

Cat.No.	Product Description	Pack Size	HSN	Unit Price
CLS0063RA	Rat betatrophin(betatrophin)ELISA Kit	96 Test	38220090	24,500.00
CLS0064RA	Rat nitric oxide,NO ELISA Kit	96 Test	38220090	24,500.00
CLS0065RA	Rat irisin(irisin)ELISA Kit	96 Test	38220090	24,500.00
CLS0066RA	Rat Ghrelin(GHRL) ELISA Kit	96 Test	38220090	24,500.00
CLS0067RA	Rat heat shock protein 70,hSP-70 ELISA Kit	96 Test	38220090	24,500.00
CLS0068RA	Rat hydroxyproline,Hyp ELISA Kit	96 Test	38220090	24,500.00
CLS0069RA	Rat Hepcidin,Hepc ELISA Kit	96 Test	38220090	24,500.00
CLS0070RA	Rat Phosphorylated Glycogen synthase kinase-3 beta(pGSK-3B)ELISA Kit	96 Test	38220090	24,500.00
CLS0071RA	Rat Phosphorylated Glycogen synthase kinase 3(pGSK-3)ELISA Kit	96 Test	38220090	24,500.00
CLS0072RA	Rat Cold-inducible RNA-binding protein(CIRBP)ELISA Kit	96 Test	38220090	24,500.00
CLS0073RA	Rat Apelin 36(AP-36)ELISA Kit	96 Test	38220090	24,500.00
CLS0074RA	Rat Glycogen synthase kinase-3 beta,Gsk3b ELISA Kit	96 Test	38220090	24,500.00
CLS0075RA	Rat Permeability Glycoprotein(P-GP)ELISA Kit	96 Test	38220090	24,500.00
CLS0076RA	Rat adiponectin,ADP ELISA Kit	96 Test	38220090	24,500.00
CLS0077RA	Rat Prostaglandin E receptor 2(EP2)ELISA Kit	96 Test	38220090	24,500.00
CLS0078RA	Rat Myosin Heavy Chain 7,Cardiac Muscle,Beta(MYH7)ELISA Kit	96 Test	38220090	24,500.00
CLS0079RA	Rat Complement Fragment 4d(C4d)ELISA Kit	96 Test	38220090	24,500.00
CLS0080RA	Rat Trypsin(TRYPsin)ELISA Kit	96 Test	38220090	24,500.00
CLS0081RA	Rat Interferon β ,IFN- β /IFNB ELISA Kit	96 Test	38220090	24,500.00
CLS0082RA	Rat Interferon α ,IFN- α ELISA Kit	96 Test	38220090	24,500.00
CLS0083RA	Rat glucocorticoid receptor,GR ELISA Kit	96 Test	38220090	24,500.00
CLS0084RA	Rat calpain-2 catalytic subunit(CAPN2)ELISA Kit	96 Test	38220090	24,500.00
CLS0085RA	Rat calpain-1 catalytic subunit(CAPN1)ELISA kit	96 Test	38220090	24,500.00
CLS0086RA	Rat B-cell leukemia/lymphoma 2,Bcl-2 ELISA Kit	96 Test	38220090	24,500.00
CLS0087RA	Rat Soluble tumor necrosis factor alpha receptors(sTNF α R)ELISA Kit	96 Test	38220090	24,500.00
CLS0088RA	Rat Toll Interacting Protein(TOLLIP)ELISA Kit	96 Test	38220090	24,500.00
CLS0089RA	Rat Visfatin(Visfatin)ELISA Kit	96 Test	38220090	24,500.00
CLS0090RA	Rat Peroxisome proliferator-activated receptor gamma coactivator 1 alpha(PGC1 α)ELISA Kit	96 Test	38220090	24,500.00
CLS0091RA	Rat chemokine (C-C motif) ligand 17(CCL17)ELISA Kit	96 Test	38220090	24,500.00
CLS0092RA	Rat chemokine (C-C motif) ligand 22(CCL22)ELISA Kit	96 Test	38220090	24,500.00
CLS0093RA	Rat chemokine (C-C motif) ligand 16(CCL16)ELISA Kit	96 Test	38220090	24,500.00
CLS0094RA	Rat chemokine (C-C motif) ligand 2(CCL2)ELISA Kit	96 Test	38220090	24,500.00
CLS0095RA	Rat chemokine (C-C motif) ligand 1(CCL1)ELISA Kit	96 Test	38220090	24,500.00
CLS0096RA	Rat Pancreatic triacylglycerol lipase,PNLIP ELISA Kit	96 Test	38220090	24,500.00
CLS0097RA	Rat Cholecystokinin,CCK ELISA Kit	96 Test	38220090	24,500.00
CLS0098RA	Rat phosphorylated microtubule-associated protein tau(pMAPT/pTAU)ELISA Kit	96 Test	38220090	24,500.00
CLS0099RA	Rat Catechol-O-Methyltransferase(COMT)ELISA Kit	96 Test	38220090	24,500.00
CLS0100RA	Rat monoamine oxidase B(MAOB)ELISA Kit	96 Test	38220090	24,500.00
CLS0101RA	Rat monoamine oxidase A(MAOA)ELISA Kit	96 Test	38220090	24,500.00
CLS0102RA	Rat Tyrosine Hydroxylase(TH)ELISA Kit	96 Test	38220090	24,500.00
CLS0103RA	Rat Blood urea nitrogen(BUN)ELISA Kit	96 Test	38220090	24,500.00
CLS0104RA	Rat cyclooxygenase-2,COX-2 ELISA Kit	96 Test	38220090	24,500.00
CLS0105RA	Rat Hyperglycosylated Chorionic Gonadotropin(hCG)ELISA Kit	96 Test	38220090	24,500.00
CLS0106RA	Rat Chorionic Gonadotrophin β , β -CG ELISA Kit	96 Test	38220090	24,500.00
CLS0107RA	Rat Topoisomerase II(TOP2)ELISA Kit	96 Test	38220090	24,500.00
CLS0108RA	Rat coagulation factor X ,F X ELISA Kit	96 Test	38220090	24,500.00
CLS0109RA	Rat coagulation factor Xa(FXa)ELISA Kit	96 Test	38220090	24,500.00
CLS0110RA	Rat cardiac troponin I ,cTn- I ELISA Kit	96 Test	38220090	24,500.00
CLS0111RA	Rat Angiotensin converting enzyme 2,ACE2 ELISA Kit	96 Test	38220090	24,500.00
CLS0112RA	Rat Tryptophan Hydroxylase 2(TPH2)ELISA Kit	96 Test	38220090	24,500.00
CLS0113RA	Rat Nuclear factor-kappa B,NF- κ B ELISA Kit	96 Test	38220090	24,500.00
CLS0114RA	Rat Immunoglobulin A,IgA ELISA Kit	96 Test	38220090	24,500.00

Cat.No.	Product Description	Pack Size	HSN	Unit Price
CLS0115RA	Rat Super Oxidase Dimutase,SOD ELISA Kit	96 Test	38220090	24,500.00
CLS0116RA	Rat Leptin,LEP ELISA kit	96 Test	38220090	24,500.00
CLS0117RA	Rat Lactate Dehydrogenase,LDH ELISA Kit	96 Test	38220090	24,500.00
CLS0118RA	Rat Tumor necrosis factor α ,TNF- α ELISA Kit	96 Test	38220090	24,500.00
CLS0119RA	Rat Glutathione peroxidase(GPX)ELISA Kit	96 Test	38220090	24,500.00
CLS0120RA	Rat Glutathione peroxidase 1,GPx-1 ELISA Kit	96 Test	38220090	24,500.00
CLS0121RA	Rat Glutathione,GSH ELISA Kit	96 Test	38220090	24,500.00
CLS0122RA	Rat Bcl-2 associated X protein,Bax ELISA Kit	96 Test	38220090	24,500.00
CLS0123RA	Rat Catalase (CAT)ELISA Kit	96 Test	38220090	24,500.00
CLS0124RA	Rat Glucagon,GC ELISA Kit	96 Test	38220090	24,500.00
CLS0125RA	Rat Sterol regulatory element-binding protein 1(SREBP1)ELISA Kit	96 Test	38220090	24,500.00
CLS0126RA	Rat peroxisome proliferators activator receptors alpha,PPAR- α ELISA Kit	96 Test	38220090	24,500.00
CLS0127RA	Rat Tri-iodothyronine,T3 ELISA Kit	96 Test	38220090	24,500.00
CLS0128RA	Rat SREBP-1 Transcription Factor(TCF-SREBP1)ELISA Kit	96 Test	38220090	24,500.00
CLS0129RA	Rat Thyroid Hormone Receptor Beta(THRb)ELISA Kit	96 Test	38220090	24,500.00
CLS0130RA	Rat protein kinase C,PKC ELISA Kit	96 Test	38220090	24,500.00
CLS0131RA	Rat Apolipoprotein H,Apo-H ELISA Kit	96 Test	38220090	24,500.00
CLS0132RA	Rat Complement factor D/Adipsin,CFD ELISA Kit	96 Test	38220090	24,500.00
CLS0133RA	Rat type I procollagen(PC I)ELISA Kit	96 Test	38220090	24,500.00
CLS0134RA	Rat Sirtuin 3(SIRT3)ELISA Kit	96 Test	38220090	24,500.00
CLS0135RA	Rat Oxoguanine Glycosylase 1(OGG1)ELISA Kit	96 Test	38220090	24,500.00
CLS0136RA	Rat Fibrinogen,Fbg ELISA Kit	96 Test	38220090	24,500.00
CLS0137RA	Rat calreticulin, CRT ELISA Kit	96 Test	38220090	24,500.00
CLS0138RA	Rat TERF1 Interacting Nuclear Factor 2(TINF2)ELISA Kit	96 Test	38220090	24,500.00
CLS0139RA	Rat Telomere Repeat Binding Factor 2(TRF2)ELISA Kit	96 Test	38220090	24,500.00
CLS0140RA	Rat Telomere Repeat Binding Factor 1(TRF1)ELISA Kit	96 Test	38220090	24,500.00
CLS0141RA	Rat Nuclear factor erythroid 2-related factor 2,NRF2 ELISA kit	96 Test	38220090	24,500.00
CLS0142RA	Rat p53/tumor protein,p53/TP53 ELISA Kit	96 Test	38220090	24,500.00
CLS0143RA	Rat Cytochrome P450 2B6(CYP2B6)ELISA Kit	96 Test	38220090	24,500.00
CLS0144RA	Rat Cyclin-dependent kinase 4(CDK-4)ELISA Kit	96 Test	38220090	24,500.00
CLS0145RA	Rat Cyclin D(CCND)ELISA Kit	96 Test	38220090	24,500.00
CLS0146RA	Rat Cyclin A(CCNA)ELISA Kit	96 Test	38220090	24,500.00
CLS0147RA	Rat Cyclin E(CCNE)ELISA Kit	96 Test	38220090	24,500.00
CLS0148RA	Rat Sestrin 1(SES1)ELISA Kit	96 Test	38220090	24,500.00
CLS0149RA	Rat Serotonin,ST ELISA Kit	96 Test	38220090	24,500.00
CLS0150RA	Rat Neuroglobin,NGB ELISA Kit	96 Test	38220090	24,500.00
CLS0151RA	Rat 15-lipoxygenase,15-LO/LOX ELISA Kit	96 Test	38220090	24,500.00
CLS0152RA	Rat 4-hydroxynonenal(4HNE) ELISA Kit	96 Test	38220090	24,500.00
CLS0153RA	Rat Interleukin 1,IL-1 ELISA Kit	96 Test	38220090	24,500.00
CLS0154RA	Rat Estradiol 17-beta-dehydrogenase 1,HSD17B1 ELISA Kit	96 Test	38220090	24,500.00
CLS0155RA	Rat interferon-inducible protein 10,IP-10 ELISA Kit	96 Test	38220090	24,500.00
CLS0156RA	Rat Transforming Growth factor β ,TGF- β ELISA kit	96 Test	38220090	24,500.00
CLS0157RA	Rat tumor necrosis factor receptor 2,TNF-R2 ELISA Kit	96 Test	38220090	24,500.00
CLS0158RA	Rat Protein Kinase C Theta(PKC θ)ELISA Kit	96 Test	38220090	24,500.00
CLS0159RA	Rat diacyl glycerol acid(DAG/DG)ELISA Kit	96 Test	38220090	24,500.00
CLS0160RA	Rat Adropin,AD ELISA kit	96 Test	38220090	24,500.00
CLS0161RA	Rat Myelin-oligodendrocyte glycoprotein(MOG)ELISA Kit	96 Test	38220090	24,500.00
CLS0162RA	Rat angiotensinogen,aGT ELISA Kit	96 Test	38220090	24,500.00
CLS0163RA	Rat annexin V ,ANX- V ELISA Kit	96 Test	38220090	24,500.00
CLS0164RA	Rat sorbitol dehydrogenase,SDH ELISA Kit	96 Test	38220090	24,500.00
CLS0165RA	Rat Aldose reductase(AR)ELISA Kit	96 Test	38220090	24,500.00
CLS0166RA	Rat Peroxisome Proliferator-activated receptor γ ,PPAR- γ ELISA Kit	96 Test	38220090	24,500.00
CLS0167RA	Rat Renin(RENIN)ELISA Kit	96 Test	38220090	24,500.00

Cat.No.	Product Description	Pack Size	HSN	Unit Price
CLS0168RA	Rat prostacycline,PGI2 ELISA Kit	96 Test	38220090	24,500.00
CLS0169RA	Rat KI-67(KI-67)ELISA Kit	96 Test	38220090	24,500.00
CLS0170RA	Rat advanced glycation end products,AGEs ELISA Kit	96 Test	38220090	24,500.00
CLS0171RA	Rat Protein Kinase,AMP Activated Beta 1(PRKAβ1)ELISA Kit	96 Test	38220090	24,500.00
CLS0172RA	Rat connective tissue growth factor,CTGF ELISA Kit	96 Test	38220090	24,500.00
CLS0173RA	Rat Transforming Growth factor β1,TGF-β1 ELISA kit	96 Test	38220090	24,500.00
CLS0174RA	Rat alkaline phosphatase,ALP ELISA Kit	96 Test	38220090	24,500.00
CLS0175RA	Rat Argininosuccinate lyase(ASL)ELISA Kit	96 Test	38220090	24,500.00
CLS0176RA	Rat Argininosuccinate synthase(ASS1)ELISA Kit	96 Test	38220090	24,500.00
CLS0177RA	Rat secretin(SCT) ELISA Kit	96 Test	38220090	24,500.00
CLS0178RA	Rat retinoblastoma tumor suppressor,pRB ELISA kit	96 Test	38220090	24,500.00
CLS0179RA	Rat Ribosomal S6 Kinase type-1,S6K1 ELISA kit	96 Test	38220090	24,500.00
CLS0180RA	Rat advanced oxidation protein products,AOPP ELISA Kit	96 Test	38220090	24,500.00
CLS0181RA	Rat Beta-2 adrenergic receptor(ADRB2) ELISA kit	96 Test	38220090	24,500.00
CLS0182RA	Rat Muscarinic acetylcholine receptor M2(CHRM2) ELISA kit	96 Test	38220090	24,500.00
CLS0183RA	Rat Soluble Cluster of differentiation 40 ligand,sCD40L ELISA Kit	96 Test	38220090	24,500.00
CLS0184RA	Rat basic fibroblast growth factor,bFGF ELISA Kit	96 Test	38220090	24,500.00
CLS0185RA	Rat albumin(albumin)ELISA Kit	96 Test	38220090	24,500.00
CLS0186RA	Rat 5-Hydroxytryptamine,5HT ELISA Kit	96 Test	38220090	24,500.00
CLS0187RA	Rat Apolipoprotein E,Apo-E ELISA Kit	96 Test	38220090	24,500.00
CLS0188RA	Rat apoprotein B100,apo-B100 ELISA Kit	96 Test	38220090	24,500.00
CLS0189RA	Rat apoprotein A1,apo-A1 ELISA Kit	96 Test	38220090	24,500.00
CLS0190RA	Rat Vascular Endothelial cell Growth Factor,VEGF ELISA Kit	96 Test	38220090	24,500.00
CLS0191RA	Rat Glutathione reductase(GR) ELISA kit	96 Test	38220090	24,500.00
CLS0192RA	Rat growth hormone,GH ELISA KIT	96 Test	38220090	24,500.00
CLS0193RA	Rat total Procollagen Type I Intact N-terminal Propeptide(total-P1NP)ELISA Kit	96 Test	38220090	24,500.00
CLS0194RA	Rat Acylated ghrelin(AG) ELISA kit	96 Test	38220090	24,500.00
CLS0195RA	Rat Collagen Type I ,Col I ELISA Kit	96 Test	38220090	24,500.00
CLS0196RA	Rat Agouti Related Protein(AGRP)ELISA Kit	96 Test	38220090	24,500.00
CLS0197RA	Rat Intelectin-1,ITLN1/Omentin ELISA Kit	96 Test	38220090	24,500.00
CLS0198RA	Rat Retinol binding protein 4,RBP-4 ELISA Kit	96 Test	38220090	24,500.00
CLS0199RA	Rat Methemoglobin,MHB ELISA Kit	96 Test	38220090	24,500.00
CLS0200RA	Rat Acetylcholinesterase,AChE ELISA Kit	96 Test	38220090	24,500.00
CLS0201RA	Rat Interleukin 17,IL-17 ELISA KIT	96 Test	38220090	24,500.00
CLS0202RA	Rat dopamine,DA ELISA Kit	96 Test	38220090	24,500.00
CLS0203RA	Rat Resistin(Retn) ELISA Kit	96 Test	38220090	24,500.00
CLS0204RA	Rat total Tau Proteins(tr)ELISA Kit	96 Test	38220090	24,500.00
CLS0205RA	Rat Estradiol,E2 ELISA Kit	96 Test	38220090	24,500.00
CLS0206RA	Rat neuropeptide Y,NP-Y ELISA Kit	96 Test	38220090	24,500.00
CLS0207RA	Rat Progesterone,PROG ELISA kit	96 Test	38220090	24,500.00
CLS0208RA	Rat Myostatin,MSTN ELISA Kit	96 Test	38220090	24,500.00
CLS0209RA	Rat Visceral adipose-specific serine protease inhibitor,vaspin ELISA Kit	96 Test	38220090	24,500.00
CLS0210RA	Rat Mothers Against Decapentaplegic Homolog 2 (Smad2)ELISA Kit	96 Test	38220090	24,500.00
CLS0211RA	Rat Mothers Against Decapentaplegic Homolog 3 (Smad3)ELISA Kit	96 Test	38220090	24,500.00
CLS0212RA	Rat Mothers Against Decapentaplegic Homolog 4 (Smad4)ELISA Kit	96 Test	38220090	24,500.00
CLS0213RA	Ratα-Smooth muscle actin(A-SMA)ELISA Kit	96 Test	38220090	24,500.00
CLS0214RA	Rat Extracellular signal-regulated kinase(ERK)ELISA Kit	96 Test	38220090	24,500.00
CLS0215RA	Rat Vitamin D2,VD2 ELISA Kit	96 Test	38220090	24,500.00
CLS0216RA	Rat bradykinin,BK ELISA Kit	96 Test	38220090	24,500.00
CLS0217RA	Rat Factor-related Apoptosis ligand,FASL ELISA Kit	96 Test	38220090	24,500.00

Cat.No.	Product Description	Pack Size	HSN	Unit Price
CLS0218RA	Rat Pancreatic Polypeptide,PP ELISA Kit	96 Test	38220090	24,500.00
CLS0219RA	Rat Chemerin(Chemerin) ELISA Kit	96 Test	38220090	24,500.00
CLS0220RA	Rat Interleukin 4,IL-4 ELISA Kit	96 Test	38220090	24,500.00
CLS0221RA	Rat Interleukin 33,IL-33 ELISA Kit	96 Test	38220090	24,500.00
CLS0222RA	Rat Interleukin 13,IL-13 ELISA KIT	96 Test	38220090	24,500.00
CLS0223RA	Rat soluble amyloid precursor protein α (sAPP α)ELISA Kit	96 Test	38220090	24,500.00
CLS0224RA	Rat Prostaglandin F2(PGF2)ELISA Kit	96 Test	38220090	24,500.00
CLS0225RA	Rat Luteinizing Hormone-Releasing Hormone,LHRH ELISA Kit	96 Test	38220090	24,500.00
CLS0226RA	Rat Ferroportin(FPN)ELISA Kit	96 Test	38220090	24,500.00
CLS0227RA	Rat Transferrin receptor protein 2,TFR2 ELISA Kit	96 Test	38220090	24,500.00
CLS0228RA	Rat Sarcophilin(SLN)ELISA Kit	96 Test	38220090	24,500.00
CLS0229RA	Rat Vitamin A,VA ELISA Kit	96 Test	38220090	24,500.00
CLS0230RA	Rat apoptosis inducing factor,AIF ELISA Kit	96 Test	38220090	24,500.00
CLS0231RA	Rat Connexin 43(CX43)ELISA Kit	96 Test	38220090	24,500.00
CLS0232RA	Rat Connexin 40(CX40)ELISA Kit	96 Test	38220090	24,500.00
CLS0233RA	Rat Succinate receptor 1(SUCNR1)ELISA Kit	96 Test	38220090	24,500.00
CLS0234RA	Rat Tumor necrosis factor γ (TNF- γ)ELISA Kit	96 Test	38220090	24,500.00
CLS0235RA	Rat Dicarbonyl/L-Xylulose Reductase(DCXR)ELISA Kit	96 Test	38220090	24,500.00
CLS0236RA	Rat Oxidized glutathione(GSSG)ELISA Kit	96 Test	38220090	24,500.00
CLS0237RA	Rat Xanthine Oxidase(XOD)ELISA Kit	96 Test	38220090	24,500.00
CLS0238RA	rat adrenocorticotrophic hormone,ACTH ELISA Kit	96 Test	38220090	24,500.00
CLS0239RA	Rat thyroxine,T4 ELISA Kit	96 Test	38220090	24,500.00
CLS0240RA	Rat Desacyl-Ghrelin(D-GHR)ELISA Kit	96 Test	38220090	24,500.00
CLS0241RA	Rat Afamin(AFM)ELISA Kit	96 Test	38220090	24,500.00
CLS0242RA	Rat Interleukin 8,IL-8 ELISA Kit	96 Test	38220090	24,500.00
CLS0243RA	Rat deoxypridinoline,DPD ELISA Kit	96 Test	38220090	24,500.00
CLS0244RA	Rat 25-Dihydroxy vitamin D2,HVD2 ELISA Kit	96 Test	38220090	24,500.00
CLS0245RA	Rat 25-Dihydroxy vitamin D3,HVD3 ELISA Kit	96 Test	38220090	24,500.00
CLS0246RA	Rat Glucose Regulated Protein 78(GRP78)ELISA Kit	96 Test	38220090	24,500.00
CLS0247RA	Rat Vitamin D3,VD3 ELISA Kit	96 Test	38220090	24,500.00
CLS0248RA	Rat Serotonin Transporter(SERT)ELISA Kit	96 Test	38220090	24,500.00
CLS0249RA	Rat Rho-associated protein kinase 1(ROCK1)ELISA Kit	96 Test	38220090	24,500.00
CLS0250RA	Rat Thromboxane A2, TX-A2 ELISA Kit	96 Test	38220090	24,500.00
CLS0251RA	Rat Xaa-Pro Dipeptidase/Prolidase(PEPD)ELISA Kit	96 Test	38220090	24,500.00
CLS0252RA	Rat Interleukin 5,IL-5 ELISA KIT	96 Test	38220090	24,500.00
CLS0253RA	Rat Cyclic AMP response element binding protein,CREB ELISA Kit	96 Test	38220090	24,500.00
CLS0254RA	Rat Glucose transporter 1, GLUT1 ELISA Kit	96 Test	38220090	24,500.00
CLS0255RA	Rat Alanine Aminotransferase,ALT/GPT ELISA Kit	96 Test	38220090	24,500.00
CLS0256RA	Rat 12-lipoxygenase,LOX-12 ELISA Kit	96 Test	38220090	24,500.00
CLS0257RA	Rat Vitamin D-binding protein,DBP ELISA Kit	96 Test	38220090	24,500.00
CLS0258RA	Rat Pyridinoline,PYD ELISA Kit	96 Test	38220090	24,500.00
CLS0259RA	Rat Pyruvate Kinase(PK)ELISA Kit	96 Test	38220090	24,500.00
CLS0260RA	Rat Fibronectin,FN ELISA Kit	96 Test	38220090	24,500.00
CLS0261RA	Rat fibroblast growth factor 2,FGF2 ELISA Kit	96 Test	38220090	24,500.00
CLS0262RA	Rat transforming growth factor α ,TGF- α ELISA Kit	96 Test	38220090	24,500.00
CLS0263RA	Rat Protein Kinase A(PKA)ELISA Kit	96 Test	38220090	24,500.00
CLS0264RA	Rat Collagen alpha-1(X) chain(COL10A1)ELISA Kit	96 Test	38220090	24,500.00
CLS0265RA	Rat β -Thromboglobulin, β -TG ELISA Kit	96 Test	38220090	24,500.00
CLS0266RA	Rat inducible nitric oxide synthase,iNOS/NOS2 ELISA Kit	96 Test	38220090	24,500.00
CLS0267RA	Rat Interleukin 12,IL-12/P70 ELISA KIT	96 Test	38220090	24,500.00
CLS0268RA	Rat Complement 4,C4 ELISA Kit	96 Test	38220090	24,500.00
CLS0269RA	Rat heme oxygenase 1,HO-1 ELISA Kit	96 Test	38220090	24,500.00
CLS0270RA	Rat Cyclic guanosine monophosphate,cGMP ELISA Kit	96 Test	38220090	24,500.00
CLS0271RA	Rat Granulocyte-Macrophage Colony Stimulating Factor,GM-CSF ELISA Kit	96 Test	38220090	24,500.00
CLS0272RA	Rat intercellular adhesion molecule 1,ICAM-1 ELISA Kit	96 Test	38220090	24,500.00
CLS0273RA	Rat fibroblast growth factor-23,FGF-23 ELISA Kit	96 Test	38220090	24,500.00

Cat.No.	Product Description	Pack Size	HSN	Unit Price
CLS0274RA	Rat Adipolin(Adipolin)ELISA Kit	96 Test	38220090	24,500.00
CLS0275RA	Rat ATP-binding cassette sub-family G member 8(ABCG8)ELISA Kit	96 Test	38220090	24,500.00
CLS0276RA	Rat ATP-binding cassette sub-family G member 5(ABCG5)ELISA Kit	96 Test	38220090	24,500.00
CLS0277RA	Rat Alpha-fetoprotein,AFP ELISA Kit	96 Test	38220090	24,500.00
CLS0278RA	Rat cyclooxygenase-1(COX-1)ELISA Kit	96 Test	38220090	24,500.00
CLS0279RA	Rat High Density Lipoprotein cholesterol(HDL-C)ELISA Kit	96 Test	38220090	24,500.00
CLS0280RA	Rat Low Density Lipoprotein cholesterol(LDL-C)ELISA Kit	96 Test	38220090	24,500.00
CLS0281RA	Rat Alpha-crystallin B chain(CRYAB)ELISA Kit	96 Test	38220090	24,500.00
CLS0282RA	Rat Cytochrome-C1,Cyt-C1 ELISA Kit	96 Test	38220090	24,500.00
CLS0283RA	Rat 3-Nitrotyrosine,3-NT ELISA Kit	96 Test	38220090	24,500.00
CLS0284RA	Rat Collagen Type II,Col II ELISA Kit	96 Test	38220090	24,500.00
CLS0285RA	Rat Collagen type I alpha 2,COL1A2/Collagen I ELISA Kit	96 Test	38220090	24,500.00
CLS0286RA	Rat Casein Kinase 2, beta (CSNK2B)ELISA KIT	96 Test	38220090	24,500.00
CLS0287RA	Rat Fatty acid-binding protein 9(FABP9/T-FABP)ELISA Kit	96 Test	38220090	24,500.00
CLS0288RA	Rat soluble tumor necrosis factor-like weak inducer of apoptosis(sTWEAK)ELISA Kit	96 Test	38220090	24,500.00
CLS0289RA	Rat D-Dimer(D2D)ELISA Kit	96 Test	38220090	24,500.00
CLS0290RA	Rat Ischemia Modified Albumin,IMA ELISA Kit	96 Test	38220090	24,500.00
CLS0291RA	Rat Signal peptide, CUB and EGF-like domain-containing protein 1(SCUBE1) ELISA Kit	96 Test	38220090	24,500.00
CLS0292RA	Rat Neprilysin(NEP)ELISA Kit	96 Test	38220090	24,500.00
CLS0293RA	Rat Beta-Site APP Cleaving Enzyme 1(bACE1)ELISA Kit	96 Test	38220090	24,500.00
CLS0294RA	Rat Pentraxin 3(PTX3)ELISA Kit	96 Test	38220090	24,500.00
CLS0295RA	Rat Sclerostin(SOST)ELISA Kit	96 Test	38220090	24,500.00
CLS0296RA	Rat Dickkopf 1(DKK1)ELISA Kit	96 Test	38220090	24,500.00
CLS0297RA	Rat Troponin T,Tn-T ELISA Kit	96 Test	38220090	24,500.00
CLS0298RA	Rat Collagenase I(Collagenase I)ELISA Kit	96 Test	38220090	24,500.00
CLS0299RA	Rat proliferating cell nuclear antigen antibody,PCNA ELISA Kit	96 Test	38220090	24,500.00
CLS0300RA	Rat Homocysteine,Hcy ELISA Kit	96 Test	38220090	24,500.00
CLS0301RA	Rat soluble receptor for advanced glycation end products(sRAGE)ELISA Kit	96 Test	38220090	24,500.00
CLS0302RA	Rat Osteocalcin/Bone gla protein,OT/BGP ELISA kit	96 Test	38220090	24,500.00
CLS0303RA	Rat β -catenin, β -cat ELISA Kit	96 Test	38220090	24,500.00
CLS0304RA	Rat oxytocin(OT)ELISA Kit	96 Test	38220090	24,500.00
CLS0305RA	Rat Soluble Vascular Endothelial Growth Factor Receptor 1(SFLT-1)ELISA Kit	96 Test	38220090	24,500.00
CLS0306RA	Rat placenta growth factor,PLGF ELISA kit	96 Test	38220090	24,500.00
CLS0307RA	Rat anti-sperm antibody,AsAb ELISA Kit	96 Test	38220090	24,500.00
CLS0308RA	Rat Dopamine D1 receptor,D1R ELISA Kit	96 Test	38220090	24,500.00
CLS0309RA	Rat cathepsin D,cath-D ELISA Kit	96 Test	38220090	24,500.00
CLS0310RA	Rat anti-diuretic hormone/vasopressin/arginine vasopressin,ADH/VP/AVP ELISA Kit	96 Test	38220090	24,500.00
CLS0311RA	Rat Total antioxidant capacity(T-AOC)ELISA Kit	96 Test	38220090	24,500.00
CLS0312RA	Rat Apelin ,AP ELISA Kit	96 Test	38220090	24,500.00
CLS0313RA	Rat Nerve growth factor,NGF ELISA kit	96 Test	38220090	24,500.00
CLS0314RA	Rat Brain derived neurotrophic facor,BDNF ELISA Kit	96 Test	38220090	24,500.00
CLS0315RA	Rat catecholamine,CA ELISA Kit	96 Test	38220090	24,500.00
CLS0316RA	Rat inositol 1,4,5,-trisphosphate,IP3 ELISA kit	96 Test	38220090	24,500.00
CLS0317RA	Rat Histamine,HIS ELISA Kit	96 Test	38220090	24,500.00
CLS0318RA	Rat Neurotrophin 3,NT-3 ELISA KIT	96 Test	38220090	24,500.00
CLS0319RA	Rat Interferon γ ,IFN- γ ELISA Kit	96 Test	38220090	24,500.00
CLS0320RA	Rat pituitary adenylate cyclase activating polypeptide,PACAP ELISA Kit	96 Test	38220090	24,500.00
CLS0321RA	Rat plasmin-antiplasmin complex,PAP ELISA Kit	96 Test	38220090	24,500.00
CLS0322RA	Rat Aspartate aminotransferase,GOT/GPT ELISA Kit	96 Test	38220090	24,500.00
CLS0323RA	Rat Adenosine triphosphate(ATP) ELISA Kit	96 Test	38220090	24,500.00

Cat.No.	Product Description	Pack Size	HSN	Unit Price
CLS0324RA	Rat prealbumin,PA ELISA Kit	96 Test	38220090	24,500.00
CLS0325RA	Rat thyrotropin-releasing hormone,TRH ELISA KIT	96 Test	38220090	24,500.00
CLS0326RA	Rat Nesfatin1(Nes-1)ELISA kit	96 Test	38220090	24,500.00
CLS0327RA	Rat Gamma-aminobutyric acid,GABA ELISA Kit	96 Test	38220090	24,500.00
CLS0328RA	Rat matrix metalloproteinase 1,MMP-1 ELISA kit	96 Test	38220090	24,500.00
CLS0329RA	Rat glial fibrillary acidic protein,GFAP ELISA Kit	96 Test	38220090	24,500.00
CLS0330RA	Rat Neurotrophic Tyrosine Kinase Receptor Type 2(NTRK2)ELISA Kit	96 Test	38220090	24,500.00
CLS0331RA	Rat Dihydropyrimidinase like protein 2(DPYSL2)ELISA Kit	96 Test	38220090	24,500.00
CLS0332RA	Rat Endothelin 1,ET-1 ELISA Kit	96 Test	38220090	24,500.00
CLS0333RA	Rat Endothelin 2,ET-2 ELISA Kit	96 Test	38220090	24,500.00
CLS0334RA	Rat kynurenine,KYN Elisa kit	96 Test	38220090	24,500.00
CLS0335RA	Rat Norepinephrine,NOR ELISA Kit	96 Test	38220090	24,500.00
CLS0336RA	Rat Vanillylmandelic acid(VMA)ELISA Kit	96 Test	38220090	24,500.00
CLS0337RA	Rat 5-hydroxyindoleacetic acid,5-HIAA ELISA Kit	96 Test	38220090	24,500.00
CLS0338RA	Rat Bone-specific Alkphase B,ALP-B ELISA Kit	96 Test	38220090	24,500.00
CLS0339RA	Rat Cross-linked Carboxy-terminal telopeptide of type I collagen, I CTP ELISA Kit	96 Test	38220090	24,500.00
CLS0340RA	Rat Kynureninase(KYNU)ELISA Kit	96 Test	38220090	24,500.00
CLS0341RA	Rat Histone deacetylase 3,HDAC3 Elisa kit	96 Test	38220090	24,500.00
CLS0342RA	Rat Coronin 1A(CORO1A)ELISA Kit	96 Test	38220090	24,500.00
CLS0343RA	Rat Vasoactive Intestinal Peptide,VIP ELISA Kit	96 Test	38220090	24,500.00
CLS0344RA	Rat Complement 3,C3 ELISA Kit	96 Test	38220090	24,500.00
CLS0345RA	Rat UDP-glucumno-syltransferase 1(UGT1)ELISA Kit	96 Test	38220090	24,500.00
CLS0346RA	Rat NADPH--cytochrome P450 reductase(POR)ELISA Kit	96 Test	38220090	24,500.00
CLS0347RA	Rat Cytochrome P450 2D6(CYP2D6)ELISA Kit	96 Test	38220090	24,500.00
CLS0348RA	Rat Cytochrome P450 3A4(CYP3A4)ELISA Kit	96 Test	38220090	24,500.00
CLS0349RA	Rat Interleukin 9,IL-9 ELISA KIT	96 Test	38220090	24,500.00
CLS0350RA	Rat Estrogen Receptor beta,ER-beta ELISA Kit	96 Test	38220090	24,500.00
CLS0351RA	Rat Butyrylcholinesterase(BCHE)ELISA Kit	96 Test	38220090	24,500.00
CLS0352RA	Rat Parathyroid hormone,PTH ELISA Kit	96 Test	38220090	24,500.00
CLS0353RA	Rat bone alkaline phosphatase,BALP ELISA Kit	96 Test	38220090	24,500.00
CLS0354RA	Rat estrogen,E ELISA Kit	96 Test	38220090	24,500.00
CLS0355RA	Rat Histone deacetylase 1,HDAC1 ELISA KIT	96 Test	38220090	24,500.00
CLS0356RA	Rat 50% complement hemolysis(CH50)ELISA Kit	96 Test	38220090	24,500.00
CLS0357RA	Rat Complement fragment 3a,C3a ELISA Kit	96 Test	38220090	24,500.00
CLS0358RA	Rat Interleukin 20(IL-20)ELISA Kit	96 Test	38220090	24,500.00
CLS0359RA	Rat Receptor Activity Modifying Protein 1(RAMP1)ELISA Kit	96 Test	38220090	24,500.00
CLS0360RA	Rat c-fos(c-fos)ELISA Kit	96 Test	38220090	24,500.00
CLS0361RA	Rat Immunoglobulin G2(IgG2)ELISA Kit	96 Test	38220090	24,500.00
CLS0362RA	Rat Immunoglobulin G1(IgG1)ELISA Kit	96 Test	38220090	24,500.00
CLS0363RA	Rat Bactericidal permeability-increasing protein,BPI ELISA Kit	96 Test	38220090	24,500.00
CLS0364RA	Rat lipid peroxide,LPO ELISA Kit	96 Test	38220090	24,500.00
CLS0365RA	Rat Sirtuin 1(SIRT1)ELISA Kit	96 Test	38220090	24,500.00
CLS0366RA	Rat cysteinyl aspartate specific proteinases-9,Caspase-9 ELISA Kit	96 Test	38220090	24,500.00
CLS0367RA	Rat Acetyl-CoA Acetyltransferase 1(ACAT1)ELISA Kit	96 Test	38220090	24,500.00
CLS0368RA	Rat 1,5-Anhydroglucitol (1,5-AG)ELISA kit	96 Test	38220090	24,500.00
CLS0369RA	Rat soluble Toll-like receptor 6,sTLR-6 ELISA Kit	96 Test	38220090	24,500.00
CLS0370RA	Rat soluble Toll-like receptor 2,sTLR-2 ELISA Kit	96 Test	38220090	24,500.00
CLS0371RA	Rat amyloid beta peptide 1-40,Aβ1-40 ELISA Kit	96 Test	38220090	24,500.00
CLS0372RA	Rat amyloid beta peptide 1-42,Aβ1-42 ELISA Kit	96 Test	38220090	24,500.00
CLS0373RA	Rat Troponin I ,Tn- I ELISA Kit	96 Test	38220090	24,500.00
CLS0374RA	Rat Thrombospondin 1,TSP-1 ELISA Kit	96 Test	38220090	24,500.00
CLS0375RA	Rat Interleukin 11,IL-11 ELISA KIT	96 Test	38220090	24,500.00
CLS0376RA	Rat Calprotectin(CALP)ELISA Kit	96 Test	38220090	24,500.00
CLS0377RA	Rat Pepsin,PP ELISA Kit	96 Test	38220090	24,500.00

Cat.No.	Product Description	Pack Size	HSN	Unit Price
CLS0378RA	Rat macrophage inflammatory protein 2,MIP-2 ELISA kit	96 Test	38220090	24,500.00
CLS0379RA	Rat reactive oxygen species,ROS ELISA Kit	96 Test	38220090	24,500.00
CLS0380RA	Rat glutathione S-transferases,GSTs ELISA Kit	96 Test	38220090	24,500.00
CLS0381RA	Rat Granulocyte Colony Stimulating Factor,G-CSF ELISA Kit	96 Test	38220090	24,500.00
CLS0382RA	Rat C-Peptide(C-P)ELISA Kit	96 Test	38220090	24,500.00
CLS0383RA	Rat Cytochrome P450 19A1,CYP19A1 ELISA Kit	96 Test	38220090	24,500.00
CLS0384RA	Rat glucocorticoid,GC ELISA Kit	96 Test	38220090	24,500.00
CLS0385RA	Rat heart fatty acid binding protein,h-FABP ELISA Kit	96 Test	38220090	24,500.00
CLS0386RA	Rat Glucose dependent insulin releasing polypeptide,GIP ELISA Kit	96 Test	38220090	24,500.00
CLS0387RA	Rat Klotho(KL)ELISA Kit	96 Test	38220090	24,500.00
CLS0388RA	Rat cholesterol,CH ELISA Kit	96 Test	38220090	24,500.00
CLS0389RA	Rat CX3C-chemokine/Fractalkine,FKN/CX3CL1 ELISA Kit	96 Test	38220090	24,500.00
CLS0390RA	Rat Interleukin-2 receptor,IL-2R/CD122 ELISA kit	96 Test	38220090	24,500.00
CLS0391RA	Rat Glutamate[NMDA]receptor subunit epsilon-1(GRIN2A)ELISA Kit	96 Test	38220090	24,500.00
CLS0392RA	Rat Glutamate[NMDA]receptor subunit epsilon-2(GRIN2B)ELISA Kit	96 Test	38220090	24,500.00
CLS0393RA	Rat Neopterin(NEOP) ELISA Kit	96 Test	38220090	24,500.00
CLS0394RA	Rat neutrophil gelatinase-associated lipocalin,NGAL ELISA Kit	96 Test	38220090	24,500.00
CLS0395RA	Rat Cystatin C,Cys-C ELISA Kit	96 Test	38220090	24,500.00
CLS0396RA	Rat Kidney injury molecule 1,Kim-1 ELISA Kit	96 Test	38220090	24,500.00
CLS0397RA	Rat peroxisome proliferator-activated receptor γ coactivator-1a(PGC-1a)ELISA Kit	96 Test	38220090	24,500.00
CLS0398RA	Rat phosphorylation AKT(p-AKT)ELISA Kit	96 Test	38220090	24,500.00
CLS0399RA	Rat extracellular signal-regulated kinase 2,ERK2 ELISA KIT	96 Test	38220090	24,500.00
CLS0400RA	Rat extracellular signal-regulated kinase 1,ERK1 ELISA KIT	96 Test	38220090	24,500.00
CLS0401RA	Rat hydroxyphenylpyruvate dioxygenase(HPD)ELISA Kit	96 Test	38220090	24,500.00
CLS0402RA	Rat purine nucleoside phosphorylase(PNP)ELISA Kit	96 Test	38220090	24,500.00
CLS0403RA	Rat Malate Dehydrogenase(MDH)ELISA Kit	96 Test	38220090	24,500.00
CLS0404RA	Rat Glutamate dehydrogenase(GDH,GLDH)ELISA Kit	96 Test	38220090	24,500.00
CLS0405RA	Rat gamma glutamyl transpeptidase,GGT ELISA Kit	96 Test	38220090	24,500.00
CLS0406RA	Rat COP9 signalosome complex subunit 1(GPS1)ELISA Kit	96 Test	38220090	24,500.00
CLS0407RA	Rat Microtubule Associated Protein Tau(MAPT)ELISA Kit	96 Test	38220090	24,500.00
CLS0408RA	Rat Fibronectin type III domain-containing protein 5,FNDC5/FRCP2 ELISA Kit	96 Test	38220090	24,500.00
CLS0409RA	Rat Cortisol(COR) ELISA Kit	96 Test	38220090	24,500.00
CLS0410RA	Rat Melatonin,MT/MLT ELISA Kit	96 Test	38220090	24,500.00
CLS0411RA	Rat α -glutathione S-transferases, α -GST ELISA Kit	96 Test	38220090	24,500.00
CLS0412RA	Rat Myelin associated glycoprotein,MAG ELISA Kit	96 Test	38220090	24,500.00
CLS0413RA	Rat CXC-chemokine ligand 11,CXCL11 ELISA kit	96 Test	38220090	24,500.00
CLS0414RA	Rat extracellular superoxide dismutase,Cu/Zn-SOD/SOD3 ELISA KIT	96 Test	38220090	24,500.00
CLS0415RA	Rat Glycogen Phosphorylase Liver(PYGL)ELISA Kit	96 Test	38220090	24,500.00
CLS0416RA	Rat very low density lipoprotein(VLDL)ELISA Kit	96 Test	38220090	24,500.00
CLS0417RA	Rat Angiotensin 2,ANG-2 ELISA Kit	96 Test	38220090	24,500.00
CLS0418RA	Rat carbohydrate-deficient transferrin,CDT ELISA Kit	96 Test	38220090	24,500.00
CLS0419RA	Rat cytochrome P450,CYP450 ELISA Kit	96 Test	38220090	24,500.00
CLS0420RA	Rat Androsterone(ADT)ELISA Kit	96 Test	38220090	24,500.00
CLS0421RA	Rat Cytochrome P450 3A5(CYP3A5)ELISA Kit	96 Test	38220090	24,500.00
CLS0422RA	Rat Cytochrome P450 1A2(CYP1A2)ELISA Kit	96 Test	38220090	24,500.00
CLS0423RA	Rat Cytochrome P450 2C9(CYP2C9)ELISA Kit	96 Test	38220090	24,500.00
CLS0424RA	Rat Cytochrome P450 2C19(CYP2C19)ELISA Kit	96 Test	38220090	24,500.00
CLS0425RA	Rat Cytochrome P450 1B1(CYP1B1)ELISA Kit	96 Test	38220090	24,500.00
CLS0426RA	Rat matrix metalloproteinase 7,MMP-7 ELISA kit	96 Test	38220090	24,500.00

Cat.No.	Product Description	Pack Size	HSN	Unit Price
CLS0427RA	Rat Macrophage Colony-Stimulating Factor,M-CSF ELISA kit	96 Test	38220090	24,500.00
CLS0428RA	Rat Lactoferrin,LTF/LF ELISA kit	96 Test	38220090	24,500.00
CLS0429RA	Rat Laminin,LN ELISA kit	96 Test	38220090	24,500.00
CLS0430RA	Rat Lipin(Lipin)ELISA Kit	96 Test	38220090	24,500.00
CLS0431RA	Rat Lipopolysaccharides/lipooligosaccharide,LPS/LOS ELISA Kit	96 Test	38220090	24,500.00
CLS0432RA	Rat Lipoprotein Associated Phospholipase A2(LP-PLA2)ELISA Kit	96 Test	38220090	24,500.00
CLS0433RA	Rat Kisspeptin 1(KISS-1) ELISA Kit	96 Test	38220090	24,500.00
CLS0434RA	Rat Interleukin 17A,IL-17A ELISA Kit	96 Test	38220090	24,500.00
CLS0435RA	Rat intestinal fatty acid binding protein,iFABP ELISA Kit	96 Test	38220090	24,500.00
CLS0436RA	Rat Interleukin 2,IL-2 ELISA kit	96 Test	38220090	24,500.00
CLS0437RA	Rat Interleukin 22,IL-22 ELISA kit	96 Test	38220090	24,500.00
CLS0438RA	Rat Interleukin 23,IL-23 ELISA Kit	96 Test	38220090	24,500.00
CLS0439RA	Rat Interleukin 26(IL-26)ELISA Kit	96 Test	38220090	24,500.00
CLS0440RA	Rat Interleukin 10,IL-10 ELISA KIT	96 Test	38220090	24,500.00
CLS0441RA	Rat inhibin B,INH-B ELISA Kit	96 Test	38220090	24,500.00
CLS0442RA	Rat Hyaluronic acid,HA ELISA Kit	96 Test	38220090	24,500.00
CLS0443RA	Rat hypoxia-inducible factor 1 α ,HIF-1 α ELISA Kit	96 Test	38220090	24,500.00
CLS0444RA	Rat High density lipoprotein,HDL ELISA Kit	96 Test	38220090	24,500.00
CLS0445RA	Rat Hemoglobin A1C(Hba1C)ELISA Kit	96 Test	38220090	24,500.00
CLS0446RA	Rat hepatic lipase,HL ELISA Kit	96 Test	38220090	24,500.00
CLS0447RA	Rat hepatocyte growth factor,HGF ELISA kit	96 Test	38220090	24,500.00
CLS0448RA	Rat heat shock protein 90,hSP-90 ELISA Kit	96 Test	38220090	24,500.00
CLS0449RA	Rat heme oxygenase 2,HO-2 ELISA Kit	96 Test	38220090	24,500.00
CLS0450RA	Rat Growth Hormone Releasing Peptide-ghrelin,GHRP-ghrelin ELISA Kit	96 Test	38220090	24,500.00
CLS0451RA	Rat Glycogen phosphorylase,GP ELISA Kit	96 Test	38220090	24,500.00
CLS0452RA	Rat Glycogen synthase,GYS/GYS1 ELISA Kit	96 Test	38220090	24,500.00
CLS0453RA	Rat Gonadotropin-releasing hormone receptor,GnRHR ELISA Kit	96 Test	38220090	24,500.00
CLS0454RA	Rat glucocorticoid receptor- α ,GR- α ELISA Kit	96 Test	38220090	24,500.00
CLS0455RA	Rat Vascular Endothelial cell Growth Factor C,VEGF-C ELISA kit	96 Test	38220090	24,500.00
CLS0456RA	Rat Tumour necrosis factor related weak inducer of apoptosis,TWEAK ELISA Kit	96 Test	38220090	24,500.00
CLS0457RA	Rat trypsinogen activation peptide,TAP ELISA Kit	96 Test	38220090	24,500.00
CLS0458RA	Rat Tumor necrosis factor β ,TNF- β ELISA Kit	96 Test	38220090	24,500.00
CLS0459RA	Rat soluble platelet endothelial cell adhesion molecule 1,sPECAM-1/sCD31 ELISA Kit	96 Test	38220090	24,500.00
CLS0460RA	Rat total cholesterol,TC ELISA Kit	96 Test	38220090	24,500.00
CLS0461RA	Rat soluble cluster of differentiation 14,sCD14 ELISA Kit	96 Test	38220090	24,500.00
CLS0462RA	Rat Thromboxane B2,TXB2 ELISA Kit	96 Test	38220090	24,500.00
CLS0463RA	Rat Tissue-type Plasminogen Actilyse,t-PA ELISA Kit	96 Test	38220090	24,500.00
CLS0464RA	Rat Salusin Beta,Salusin- β ELISA Kit	96 Test	38220090	24,500.00
CLS0465RA	Rat Salusin α (Salusin α)ELISA Kit	96 Test	38220090	24,500.00
CLS0466RA	Rat Secreted Frizzled Related Protein 4 (SFRP4)ELISA Kit	96 Test	38220090	24,500.00
CLS0467RA	Rat secretory immunoglobulin A,sIgA ELISA Kit	96 Test	38220090	24,500.00
CLS0468RA	Rat Serum amyloid A,SAA ELISA Kit	96 Test	38220090	24,500.00
CLS0469RA	Rat sex hormone-binding globulin,SHBG ELISA Kit	96 Test	38220090	24,500.00
CLS0470RA	Rat S100 calcium binding protein A8/calgranulin A,S100A8 ELISA Kit	96 Test	38220090	24,500.00
CLS0471RA	Rat Reverse Tri-iodothyronine(rT3)ELISA Kit	96 Test	38220090	24,500.00
CLS0472RA	Rat S100 calcium binding protein A9/calgranulin B,S100A9 ELISA Kit	96 Test	38220090	24,500.00
CLS0473RA	Rat Prostaglandin F2 α ,PGF2 α ELISA Kit	96 Test	38220090	24,500.00
CLS0474RA	Rat Pyruvate kinase isozymes M1/M2,M2-PK ELISA Kit	96 Test	38220090	24,500.00
CLS0475RA	Rat receptor activator of nuclear factor kappa B ligand,RANKL ELISA Kit	96 Test	38220090	24,500.00

Cat.No.	Product Description	Pack Size	HSN	Unit Price
CLS0476RA	Rat Renalase(RNLS) ELISA Kit	96 Test	38220090	24,500.00
CLS0477RA	Rat Retinol-binding protein,RBP ELISA Kit	96 Test	38220090	24,500.00
CLS0478RA	Rat plasminogen activator inhibitor 1,PAI-1 ELISA Kit	96 Test	38220090	24,500.00
CLS0479RA	Rat Phosphorylated adenosine monophosphate activated protein kinase,AMPK ELISA kit	96 Test	38220090	24,500.00
CLS0480RA	Rat Pulmonary surfatcant-associated protein D,SP-D ELISA Ki	96 Test	38220090	24,500.00
CLS0481RA	Rat phospho Protein Kinase C,P-PKC ELISA Kit	96 Test	38220090	24,500.00
CLS0482RA	Rat phosphoenolpyruvate carboxykinase,PCK ELISA Kit	96 Test	38220090	24,500.00
CLS0483RA	Rat protein kinase B,PKB ELISA Kit	96 Test	38220090	24,500.00
CLS0484RA	Rat Pulmonary surfatcant-associated protein A,SP-A ELISA Ki	96 Test	38220090	24,500.00
CLS0485RA	Rat Procollagen III C-terminal peptide(P III CP) ELISA Kit	96 Test	38220090	24,500.00
CLS0486RA	Rat Proinsulin,PI ELISA Kit	96 Test	38220090	24,500.00
CLS0487RA	Rat Procalcitonin,PCT ELISA Kit	96 Test	38220090	24,500.00
CLS0488RA	Rat procollagen I N-terminal peptide,P I NP ELISA Kit	96 Test	38220090	24,500.00
CLS0489RA	Rat pro-opiomelanocortin,POMC ELISA Kit	96 Test	38220090	24,500.00
CLS0490RA	Rat Microalbumin,Malb ELISA KIT	96 Test	38220090	24,500.00
CLS0491RA	Rat Microtubule-associated protein light chain 3(MAPLC3)ELISA Kit	96 Test	38220090	24,500.00
CLS0492RA	Rat platelet Selectin,P-Selectin ELISA kit	96 Test	38220090	24,500.00
CLS0493RA	Rat platelet-derived growth factor,PDGF ELISA Kit	96 Test	38220090	24,500.00
CLS0494RA	Rat lipoprotein lipase,LPL ELISA Kit	96 Test	38220090	24,500.00
CLS0495RA	Rat low density lipoprotein,LDL ELISA Kit	96 Test	38220090	24,500.00
CLS0496RA	Rat Phosphotylinosital 3 kinase,PI3K ELISA Kit	96 Test	38220090	24,500.00
CLS0497RA	Rat Interleukin 27,IL-27 ELISA Kit	96 Test	38220090	24,500.00
CLS0498RA	Rat Leptin Soluble Receptor,sLR ELISA Kit	96 Test	38220090	24,500.00
CLS0499RA	Rat Phosphofructokinase,PFK ELISA Kit	96 Test	38220090	24,500.00
CLS0500RA	Rat Interleukin 21,IL-21 ELISA Kit	96 Test	38220090	24,500.00
CLS0501RA	Rat Phosphatidylinositol-3,4,5-trisphosphate 3- phosphatase and dual-specificity protein phosphatase PTEN,PTEN ELISA kit	96 Test	38220090	24,500.00
CLS0502RA	Rat phospho-inhibitory subunit of NF-κBα,pIKBα ELISA kit	96 Test	38220090	24,500.00
CLS0503RA	Rat Immunoglobulin E,IgE ELISA Kit	96 Test	38220090	24,500.00
CLS0504RA	Rat Immunoglobulin M,IgM ELISA Kit	96 Test	38220090	24,500.00
CLS0505RA	Rat oxidized lowdensity lipoprotein,OxLDL ELISA Kit	96 Test	38220090	24,500.00
CLS0506RA	Rat Pentraxin 3(PTX3)ELISA Kit	96 Test	38220090	24,500.00
CLS0507RA	Rat Perforin/Pore-forming protein,PF/PFP ELISA Kit	96 Test	38220090	24,500.00
CLS0508RA	Rat ovalbumin specific IgG,OVA sIgG ELISA Kit	96 Test	38220090	24,500.00
CLS0509RA	Rat ovalbumin specific IgG1,OVA sIgG1 ELISA Kit	96 Test	38220090	24,500.00
CLS0510RA	Rat Osteopontin,OPN ELISA Kit	96 Test	38220090	24,500.00
CLS0511RA	Rat Osteoprotegerin,OPG ELISA KIT	96 Test	38220090	24,500.00
CLS0512RA	Rat ovalbumin IgE,OVA IgE ELISA Kit	96 Test	38220090	24,500.00
CLS0513RA	Rat nuclear factor-κB p65,NF-κB p65 ELISA Kit	96 Test	38220090	24,500.00
CLS0514RA	Rat Nuclear respiratory factor 1,NRF1 ELISA Kit	96 Test	38220090	24,500.00
CLS0515RA	Rat Ornithine decarboxylase,ODC1 ELISA Kit	96 Test	38220090	24,500.00
CLS0516RA	Rat neutrophil elastase,NE ELISA Kit	96 Test	38220090	24,500.00
CLS0517RA	Rat nicotinic acetylcholine receptor,N-AChR ELISA Kit	96 Test	38220090	24,500.00
CLS0518RA	Rat Free Thyroxine,FT4 ELISA Kit	96 Test	38220090	24,500.00
CLS0519RA	Rat Free Tri-iodothyronine Indes,Free-T3 ELISA Kit	96 Test	38220090	24,500.00
CLS0520RA	Rat Neuregulin 1,NRG-1 ELISA Kit	96 Test	38220090	24,500.00
CLS0521RA	Rat free KXtty acids,FKX ELISA KIT	96 Test	38220090	24,500.00
CLS0522RA	Rat Free Testosterone,F-TESTO ELISA Kit	96 Test	38220090	24,500.00
CLS0523RA	Rat fibroblast growth factor-10,FGF-10 ELISA Kit	96 Test	38220090	24,500.00
CLS0524RA	Rat Forkhead box O3A,FOXO3A ELISA Kit	96 Test	38220090	24,500.00
CLS0525RA	Rat Fcoagulation factor IX,FIX ELISA Kit	96 Test	38220090	24,500.00
CLS0526RA	Rat Fibrinogen Degradation Product,FDP ELISA Kit	96 Test	38220090	24,500.00
CLS0527RA	Rat Factor-related Apoptosis,FAS ELISA Kit	96 Test	38220090	24,500.00

Cat.No.	Product Description	Pack Size	HSN	Unit Price
CLS0528RA	Rat Fas Ligand(FL)ELISA Kit	96 Test	38220090	24,500.00
CLS0529RA	Rat Fatty acid synthase(FAS)ELISA Kit	96 Test	38220090	24,500.00
CLS0530RA	Rat Eotaxin 1(CCL11) ELISA Kit	96 Test	38220090	24,500.00
CLS0531RA	Rat Epinephrine/Adrenaline,EPI ELISA Kit	96 Test	38220090	24,500.00
CLS0532RA	Rat Erythropoietin,EPO ELISA Kit	96 Test	38220090	24,500.00
CLS0533RA	Rat Endothelial nitric oxide synthase,eNOS ELISA Kit	96 Test	38220090	24,500.00
CLS0534RA	Rat endothelium Selectin,E-Selectin ELISA kit	96 Test	38220090	24,500.00
CLS0535RA	Rat eosinophil chemotactic factor,ECF ELISA Kit	96 Test	38220090	24,500.00
CLS0536RA	Rat E2/ubiquitin-conjugating enzyme,E2/UBCE ELISA Kit	96 Test	38220090	24,500.00
CLS0537RA	Rat E3/ubiquitin-protein ligase,E3/UBPL ELISA Kit	96 Test	38220090	24,500.00
CLS0538RA	Rat dynorphin,Dyn ELISA Kit	96 Test	38220090	24,500.00
CLS0539RA	Rat E1/ubiquitin-activating enzyme,E1/UBAE ELISA Kit	96 Test	38220090	24,500.00
CLS0540RA	Rat DNA methyltransferase3 α ,DNAM3 α ELISA Kit	96 Test	38220090	24,500.00
CLS0541RA	Rat dopamine transporter,DAT ELISA Kit	96 Test	38220090	24,500.00
CLS0542RA	Rat Dipeptidase 2(DPEP2) ELISA Kit	96 Test	38220090	24,500.00
CLS0543RA	Rat DNA methyltransferase 1, DNAM1 ELISA Kit	96 Test	38220090	24,500.00
CLS0544RA	Rat deubiquitinating enzyme,DUB ELISA Kit	96 Test	38220090	24,500.00
CLS0545RA	Rat cytochrome P450 7A1,CYP7A1 ELISA Kit	96 Test	38220090	24,500.00
CLS0546RA	Rat Cytochrome-C,Cyt-C ELISA Kit	96 Test	38220090	24,500.00
CLS0547RA	Rat Cytokeratin 18-M30,CK18-M30 ELISA kit	96 Test	38220090	24,500.00
CLS0548RA	Rat Cyclin-dependent kinase inhibitor 1,CDKN1A/P21 ELISA kit	96 Test	38220090	24,500.00
CLS0549RA	Rat Cytochrome P450 1A1 (CYP1A1)ELISA kit	96 Test	38220090	24,500.00
CLS0550RA	Rat Cytochrome P450 2E1,CYP2E1 ELISA Kit	96 Test	38220090	24,500.00
CLS0551RA	Rat cyclic adenosine monophosphate,cAMP ELISA Kit	96 Test	38220090	24,500.00
CLS0552RA	Rat Cyclic AMP-dependent transcription factor ATF-2,ATF2 ELISA kit	96 Test	38220090	24,500.00
CLS0553RA	Rat CXC-chemokine receptor 2,IL8RB/CXCR2 ELISA Kit	96 Test	38220090	24,500.00
CLS0554RA	Rat CXC-chemokine receptor 4,CXCR4 ELISA Kit	96 Test	38220090	24,500.00
CLS0555RA	Rat cross linked C-telopeptide of type I collagen,CTX- I ELISA Kit	96 Test	38220090	24,500.00
CLS0556RA	Rat cross linked N-telopeptide of type I collagen,NTX ELISA Kit	96 Test	38220090	24,500.00
CLS0557RA	Rat CXC-chemokine receptor 1,CXCR1/IL8Ra ELISA Kit	96 Test	38220090	24,500.00
CLS0558RA	Rat corticotropin-releasing factor,CRF ELISA Kit	96 Test	38220090	24,500.00
CLS0559RA	Rat Creatine Kinase MB isoenzyme,CK-MB ELISA Kit	96 Test	38220090	24,500.00
CLS0560RA	Rat Creatinine,Cr ELISA Kit	96 Test	38220090	24,500.00
CLS0561RA	Rat soluble endothelium-selectin,sE-selectin ELISA Kit	96 Test	38220090	24,500.00
CLS0562RA	Rat Soluble Intercellular Adhesion Molecule 1,sICAM-1 ELISA Kit	96 Test	38220090	24,500.00
CLS0563RA	Rat soluble Interleukin 6 receptor,sIL-6R/CD126 ELISA Kit	96 Test	38220090	24,500.00
CLS0564RA	Rat soluble interleukin-2 receptor,IL-2sR α ELISA kit	96 Test	38220090	24,500.00
CLS0565RA	Rat soluble receptor activator of nuclear factor-kB ligand,sRANKL ELISA Kit	96 Test	38220090	24,500.00
CLS0566RA	Rat soluble Vascular cell adhesion molecule 1,sVCAM-1 ELISA Kit	96 Test	38220090	24,500.00
CLS0567RA	Rat Substance P,SP ELISA Kit	96 Test	38220090	24,500.00
CLS0568RA	Rat survivin,Surv ELISA kit	96 Test	38220090	24,500.00
CLS0569RA	Rat tartrate-resistant acid phosphatase 5b,TRACP-5b ELISA Kit	96 Test	38220090	24,500.00
CLS0570RA	Rat terminal complement complex C5b-9,TCC C5b-9 ELISA Kit	96 Test	38220090	24,500.00
CLS0571RA	Rat thioredoxin reductase,TrxR ELISA Kit	96 Test	38220090	24,500.00
CLS0572RA	Rat tissue inhibitors of metalloproteinase 1,TIMP-1 ELISA Kit	96 Test	38220090	24,500.00
CLS0573RA	Rat tissue inhibitors of metalloproteinase 2,TIMP-2 ELISA Kit	96 Test	38220090	24,500.00
CLS0574RA	Rat transferrin receptor,TFR ELISA Kit	96 Test	38220090	24,500.00
CLS0575RA	Rat transforming growth factors β 2,TGF β 2 ELISA Kit	96 Test	38220090	24,500.00
CLS0576RA	Rat Triglyceride,TG ELISA Kit	96 Test	38220090	24,500.00

Cat.No.	Product Description	Pack Size	HSN	Unit Price
CLS0577RA	Rat ultrasensitive thyroid-stimulating hormone,U-TSH ELISA Kit	96 Test	38220090	24,500.00
CLS0578RA	Rat Vascular cell adhesion molecule 1,VCAM-1 ELISA kit	96 Test	38220090	24,500.00
CLS0579RA	Rat Vitamin B,VB ELISA Kit	96 Test	38220090	24,500.00
CLS0580RA	Rat α 1-Acid glycoprotein, α 1-AGP ELISA Kit	96 Test	38220090	24,500.00
CLS0581RA	Rat α -Smooth muscle actin(A-SMA)ELISA Kit	96 Test	38220090	24,500.00
CLS0582RA	Rat β 2-microglobulin,BMG/ β 2-MG ELISA Kit	96 Test	38220090	24,500.00
CLS0583RA	Rat β -glucuronidase, β GD ELISA Kit	96 Test	38220090	24,500.00
CLS0584RA	Rat Somatostatin,SS ELISA Ki	96 Test	38220090	24,500.00
CLS0585RA	Rat matrix metalloproteinase 9/Gelatinase B,MMP-9 ELISA Kit	96 Test	38220090	24,500.00
CLS0586RA	Rat Melanotransferrin (MFI2)ELISA Kit	96 Test	38220090	24,500.00
CLS0587RA	Rat Metallothionein,MT ELISA Kit	96 Test	38220090	24,500.00
CLS0588RA	Rat F-box only protein 32,FBXO32/MAFbx ELISA Kit	96 Test	38220090	24,500.00
CLS0589RA	Rat Muscle-specific RING finger protein 1,MuRF1 ELISA Kit	96 Test	38220090	24,500.00
CLS0590RA	Rat Myoglobin,MYO/MB ELISA Kit	96 Test	38220090	24,500.00
CLS0591RA	Rat Natriuretic peptides B(NPPB)ELISA Kit	96 Test	38220090	24,500.00
CLS0592RA	Rat nicotinamide adenine dinucleotide phosphate,NADPH ELISA Kit	96 Test	38220090	24,500.00
CLS0593RA	Rat non-ester fatty acid(NEFA)ELISA Kit	96 Test	38220090	24,500.00
CLS0594RA	Rat Orexin A(Orexin A)ELISA Kit	96 Test	38220090	24,500.00
CLS0595RA	Rat ovalbumin specific IgA,OVA sIgA ELISA Kit	96 Test	38220090	24,500.00
CLS0596RA	Rat ovalbumin specific IgE,OVA sIgE ELISA Kit	96 Test	38220090	24,500.00
CLS0597RA	Rat Paraoxonase-1,PON1 ELISA Kit	96 Test	38220090	24,500.00
CLS0598RA	Rat Platelet-Derived Growth Factor AB,PDGF-AB ELISA kit	96 Test	38220090	24,500.00
CLS0599RA	Rat Prostaglandin E1(PGE1)ELISA Kit	96 Test	38220090	24,500.00
CLS0600RA	Rat Prostaglandin E2(PGE2)ELISA Kit	96 Test	38220090	24,500.00
CLS0601RA	Rat 1,25-dihydroxyvitamin D3,DVD/DHVD3 ELISA Kit	96 Test	38220090	24,500.00
CLS0602RA	Rat C-telopeptide of type I collagen,CTX- I ELISA Kit	96 Test	38220090	24,500.00
CLS0603RA	Rat Carboxyterminal propeptide of type I procollagen,P I CP ELISA Kit	96 Test	38220090	24,500.00
CLS0604RA	Rat C-telopeptide of type II collagen,CTX- II ELISA Kit	96 Test	38220090	24,500.00
CLS0605RA	Rat Collagen Type III,Col III ELISA Kit	96 Test	38220090	24,500.00
CLS0606RA	Rat N-terminal procollagen III propeptide,P III NP ELISA Kit	96 Test	38220090	24,500.00
CLS0607RA	Rat Collagen Type IV,Col IV ELISA KIT	96 Test	38220090	24,500.00
CLS0608RA	Rat 5-Nucleotidase,5-NT ELISA Kit	96 Test	38220090	24,500.00
CLS0609RA	Rat apelin 12,AP12 ELISA Kit	96 Test	38220090	24,500.00
CLS0610RA	Rat BH3 interacting domain death agonist,Bid ELISA Kit	96 Test	38220090	24,500.00
CLS0611RA	Rat cluster Of differentiation,CD44 ELISA Kit	96 Test	38220090	24,500.00
CLS0612RA	Rat c-jun(c-jun)ELISA Kit	96 Test	38220090	24,500.00
CLS0613RA	Rat D-Lactate Dehydrogenase,D-LDH ELISA Kit	96 Test	38220090	24,500.00
CLS0614RA	Rat N-acetyl- β -D-glucosaminidase,NAG ELISA Kit	96 Test	38220090	24,500.00
CLS0615RA	Rat substance P receptor,SP-R ELISA Kit	96 Test	38220090	24,500.00
CLS0616RA	Rat Toll-like receptor 4,TLR4 ELISA Kit	96 Test	38220090	24,500.00
CLS0617RA	Rat Beta-Endorphin, β -EP ELISA Kit	96 Test	38220090	24,500.00
CLS0618RA	Rat Beta-Hydroxybutyric Acid, β -OHB ELISA Kit	96 Test	38220090	24,500.00
CLS0619RA	Rat Interleukin 1 α ,IL-1 α ELISA kit	96 Test	38220090	24,500.00
CLS0620RA	Rat Interleukin 1 receptor antagonist,IL-1ra/CD121 ELISA kit	96 Test	38220090	24,500.00
CLS0621RA	Rat soluble interleukin-2 receptor,IL-2sR β ELISA kit	96 Test	38220090	24,500.00
CLS0622RA	Rat Interleukin 32,IL-32 ELISA Kit	96 Test	38220090	24,500.00
CLS0623RA	Rat asymmetrical dimethylarginine,ADMA ELISA kit	96 Test	38220090	24,500.00
CLS0624RA	Rat Leukotriene B4,LT-B4 ELISA Kit	96 Test	38220090	24,500.00
CLS0625RA	Rat leukemia inhibitory factor,LIF ELISA Kit	96 Test	38220090	24,500.00
CLS0626RA	Rat Epidermal growth factor,EGF ELISA Kit	96 Test	38220090	24,500.00
CLS0627RA	Rat epidermal growth factor receptor,EGFR ELISA Kit	96 Test	38220090	24,500.00

Cat.No.	Product Description	Pack Size	HSN	Unit Price
CLS0628RA	Rat Epidermal growth factor receptor 2,HER2 ELISA Kit	96 Test	38220090	24,500.00
CLS0629RA	Rat Complement fragment 5a,C5a ELISA Kit	96 Test	38220090	24,500.00
CLS0630RA	Rat Estrogen Receptor,ER ELISA Kit	96 Test	38220090	24,500.00
CLS0631RA	Rat corticotropin releasing hormone,CRH ELISA Kit	96 Test	38220090	24,500.00
CLS0632RA	Rat monocyte chemotactic protein 2,MCP-2 ELISA ki	96 Test	38220090	24,500.00
CLS0633RA	Rat monocyte chemotactic protein 4,MCP-4 ELISA kit	96 Test	38220090	24,500.00
CLS0634RA	Rat cholecystokinin octapeptide,CCK-8 ELISA Kit	96 Test	38220090	24,500.00
CLS0635RA	Rat Insulin Receptor,INSR ELISA Kit	96 Test	38220090	24,500.00
CLS0636RA	Rat diamine oxidase,DAO ELISA Kit	96 Test	38220090	24,500.00
CLS0637RA	Rat dipeptidyl peptidase 4,DPP4 ELISA Kit	96 Test	38220090	24,500.00
CLS0638RA	Rat Ubiquitin,Ub ELISA Kit	96 Test	38220090	24,500.00
CLS0639RA	Rat Mannma binding protein/mannan binding lectin,MBP/MBL ELISA Kit	96 Test	38220090	24,500.00
CLS0640RA	Rat Ultrasensitivity Tri-iodothyronine,u-T3 ELISA Kit	96 Test	38220090	24,500.00
CLS0641RA	Rat High mobility group protein B1,HMGB-1 ELISA Kit	96 Test	38220090	24,500.00
CLS0642RA	Rat Bone morphogenetic protein 2,BMP-2 ELISA Kit	96 Test	38220090	24,500.00
CLS0643RA	Rat Bone morphogenetic protein receptor II ,BMPR- II ELISA Kit	96 Test	38220090	24,500.00
CLS0644RA	Rat Complement fragment 4a,C4a ELISA Kit	96 Test	38220090	24,500.00
CLS0645RA	Rat receptor activator of nuclear factor kappa B,RANK ELISA Kit	96 Test	38220090	24,500.00
CLS0646RA	Rat matrix metalloproteinase 2/Gelatinase A,MMP-2 ELISA kit	96 Test	38220090	24,500.00
CLS0647RA	Rat matrix metalloproteinase 3,MMP-3 ELISA kit	96 Test	38220090	24,500.00
CLS0648RA	Rat matrix metalloproteinase 8/Neutrophil collagenase,MMP-8 ELISA kit	96 Test	38220090	24,500.00
CLS0649RA	Rat tissue inhibitors of metalloproteinase 4,TIMP-4 ELISA Kit	96 Test	38220090	24,500.00
CLS0650RA	Rat Stromal cell derived factor 1a,SDF-1a ELISA Kit	96 Test	38220090	24,500.00
CLS0651RA	Rat Hexokinase,HK ELISA Kit	96 Test	38220090	24,500.00
CLS0652RA	Rat Thyroid-Peroxidase,TPO ELISA Kit	96 Test	38220090	24,500.00
CLS0653RA	Rat Calcitonin,CT ELISA Kit	96 Test	38220090	24,500.00
CLS0654RA	Rat calcitonin gene related peptide,CGRP ELISA Kit	96 Test	38220090	24,500.00
CLS0655RA	Rat Haptoglobin,Hpt/HP ELISA KIT	96 Test	38220090	24,500.00
CLS0656RA	Rat macrophage inflammatory protein 1 β ,MIP-1 β ELISA kit	96 Test	38220090	24,500.00
CLS0657RA	Rat anti-Endomysial Antibody IgA,EMA IgA ELISA Kit	96 Test	38220090	24,500.00
CLS0658RA	Rat soluble platelet-selectin,sP-selectin ELISA Kit	96 Test	38220090	24,500.00
CLS0659RA	Rat tyrosine kinase B,trk B ELISA Kit	96 Test	38220090	24,500.00
CLS0660RA	Rat Biopyrrin(BPn) ELISA Kit	96 Test	38220090	24,500.00
CLS0661RA	Rat Leptin receptor,LR/Ob-R ELISA KIT	96 Test	38220090	24,500.00
CLS0662RA	Rat endotoxin,ET ELISA Kit	96 Test	38220090	24,500.00
CLS0663RA	Rat Endocrine gland vascular endothelial growth factor,EG-VEGF ELISA Kit	96 Test	38220090	24,500.00
CLS0664RA	Rat brain-gut peptides,BGP/Ghrelin Elisa kit	96 Test	38220090	24,500.00
CLS0665RA	Rat enkephalin,ENK ELISA Kit	96 Test	38220090	24,500.00
CLS0666RA	Rat brain natriuretic peptide,BNP ELISA Kit	96 Test	38220090	24,500.00
CLS0667RA	Rat Urokinase-type Plasminogen Activator Receptor,PLAUR/uPAR ELISA kit	96 Test	38220090	24,500.00
CLS0668RA	Rat Citrate synthase,CS ELISA Kit	96 Test	38220090	24,500.00
CLS0669RA	Rat Clusterin,CLU ELISA Kit	96 Test	38220090	24,500.00
CLS0670RA	Rat coagulation factor VIII related antigen,FVIII-Ag ELISA Kit	96 Test	38220090	24,500.00
CLS0671RA	Rat Glucose transporter 4 , GLUT4 ELISA Kit	96 Test	38220090	24,500.00
CLS0672RA	Rat Prostaglandin E1,PG-E1 Elisa kit	96 Test	38220090	24,500.00
CLS0673RA	Rat intact Parathormone ,i-PTH ELISA Kit	96 Test	38220090	24,500.00
CLS0674RA	Rat aldosterone,ALD ELISA Kit	96 Test	38220090	24,500.00
CLS0675RA	Rat heat shock protein 27,HSP-27 ELISA Kit	96 Test	38220090	24,500.00
CLS0676RA	Rat cartilage oligomeric matrix protein,COMP ELISA Kit	96 Test	38220090	24,500.00
CLS0677RA	Rat adrenomedullin,ADM ELISA Kit	96 Test	38220090	24,500.00

Cat.No.	Product Description	Pack Size	HSN	Unit Price
CLS0678RA	Rat growth differentiation factor 15,GDF15 ELISA Kit	96 Test	38220090	24,500.00
CLS0679RA	Rat eosinophil cationic protein,ECP ELISA Kit	96 Test	38220090	24,500.00
CLS0680RA	Rat Acid Phosphatase 1,ACP1 ELISA Kit	96 Test	38220090	24,500.00
CLS0681RA	Rat Fetuin A,FETU-A ELISA Kit	96 Test	38220090	24,500.00
CLS0682RA	Rat carbonic anhydrase,CA ELISA Ki	96 Test	38220090	24,500.00
CLS0683RA	Rat glucoprotein 130,gp130/CD130 ELISA KIT	96 Test	38220090	24,500.00
CLS0684RA	Rat Aspartate aminotransferase,AST ELISA Kit	96 Test	38220090	24,500.00
CLS0685RA	Rat ferritin,FE ELISA Kit	96 Test	38220090	24,500.00
CLS0686RA	Rat Homocysteic acid,Hcy ELISA Kit	96 Test	38220090	24,500.00
CLS0687RA	Rat Dehydroepiandrosterone,DHEA ELISA Kit	96 Test	38220090	24,500.00
CLS0688RA	Rat Vitamin B12,VB12 ELISA Kit	96 Test	38220090	24,500.00
CLS0689RA	Rat Vitamin B6,VB6 ELISA Kit	96 Test	38220090	24,500.00
CLS0690RA	Rat Vitamin C,VC ELISA Kit	96 Test	38220090	24,500.00
CLS0691RA	Rat Vitamin D,VD ELISA Kit	96 Test	38220090	24,500.00
CLS0692RA	Rat Vitamin E,VE ELISA Kit	96 Test	38220090	24,500.00
CLS0693RA	Rat Vitamin K1,VK1 ELISA Kit	96 Test	38220090	24,500.00
CLS0694RA	Rat intercellular adhesion molecule 2,ICAM-2 ELISA Kit	96 Test	38220090	24,500.00
CLS0695RA	Rat Atrial Natriuretic Peptide,ANP ELISA Kit	96 Test	38220090	24,500.00
CLS0696RA	Rat Zn-Metallothionein,Zn-MT ELISA Kit	96 Test	38220090	24,500.00
CLS0697RA	Rat Bromodeoxyuridine,BrdU ELISA Kit	96 Test	38220090	24,500.00
CLS0698RA	Rat angiotensin I ,Ang- I ELISA Kit	96 Test	38220090	24,500.00
CLS0699RA	Rat angiotensin II ,ANG- II ELISA Kit	96 Test	38220090	24,500.00
CLS0700RA	Rat Angiotensin converting enzyme,ACE ELISA Kit	96 Test	38220090	24,500.00
CLS0701RA	Rat Vascular Endothelial cell Growth Factor B,VEGF-B ELISA kit	96 Test	38220090	24,500.00
CLS0702RA	Rat Vascular Endothelial cell Growth Factor D,VEGF-D ELISA kit	96 Test	38220090	24,500.00
CLS0703RA	Rat Vasculoar endothelial cell growth factor receptor 1,VEGFR-1/Flt1 ELISA kit	96 Test	38220090	24,500.00
CLS0704RA	Rat Vasculoar endothelial cell growth factor receptor 2,VEGFR-2/Flt1 ELISA kit	96 Test	38220090	24,500.00
CLS0705RA	Rat Endoglin,ENG ELISA Kit	96 Test	38220090	24,500.00
CLS0706RA	Rat Angiopoietin 1,ANG-1 ELISA Kit	96 Test	38220090	24,500.00
CLS0707RA	Rat angiopoietin receptor Tie1,ANG-R-Tie1 ELISA KIT	96 Test	38220090	24,500.00
CLS0708RA	Rat von Willebrand Factor,vWF ELISA Kit	96 Test	38220090	24,500.00
CLS0709RA	Rat nicotinamide adenine dinucleotide phosphate,NADPH ELISA Kit	96 Test	38220090	24,500.00
CLS0710RA	Rat Insulin Receptor β ,ISR- β ELISA KIT	96 Test	38220090	24,500.00
CLS0711RA	Rat Insulin-like growth factor 1,IGF-1 ELISA Kit	96 Test	38220090	24,500.00
CLS0712RA	Rat Glucagon-like peptide 1,GLP-1 ELISA Kit	96 Test	38220090	24,500.00
CLS0713RA	Rat alcohol dehydrogenase,ADH ELISA Kit	96 Test	38220090	24,500.00
CLS0714RA	Rat acetylcholine,ACH ELISA Kit	96 Test	38220090	24,500.00
CLS0715RA	Rat Choline acetyltransferase,ChAT ELISA Kit	96 Test	38220090	24,500.00
CLS0716RA	Rat free chorionic gonadotropin,f- β CG ELISA Kit	96 Test	38220090	24,500.00
CLS0717RA	Rat Free Prostate Specific Antigen,fPSA ELISA Kit	96 Test	38220090	24,500.00
CLS0718RA	Rat Mucin-5 subtype AC,MUC5AC ELISA Kit	96 Test	38220090	24,500.00
CLS0719RA	Rat Integrin α M,ITG/CD11b ELISA Kit	96 Test	38220090	24,500.00
CLS0720RA	Rat lipoprotein α ,Lp- α ELISA Kit	96 Test	38220090	24,500.00
CLS0721RA	Rat Histone Deacetylase,HD ELISA Kit	96 Test	38220090	24,500.00
CLS0722RA	Rat Tissue factor,TF ELISA Kit	96 Test	38220090	24,500.00
CLS0723RA	Rat Ubiquitin Carboxyl Terminal Hydrolase L1 (UCHL1)ELISA Kit	96 Test	38220090	24,500.00
CLS0724RA	Rat Tumor Protein, Translationally Controlled 1 (TPT1)ELISA Kit	96 Test	38220090	24,500.00
CLS0725RA	Rat Deiodinase Iodothyronine Type II (DIO2)ELISA Kit	96 Test	38220090	24,500.00
CLS0726RA	Rat A disintegrin and metalloproteinase with thrombospondin motifs 1,ADAMTS1 ELISA kit	96 Test	38220090	24,500.00
CLS0727RA	Rat Cerebral Dopamine Neurotrophic Factor (CDNF) ELISA Kit	96 Test	38220090	24,500.00

Cat.No.	Product Description	Pack Size	HSN	Unit Price
CLS0728RA	Rat bone sialoprotein,BSP ELISA Kit	96 Test	38220090	24,500.00
CLS0729RA	Rat Glypican-3,GPC-3 ELISA Kit	96 Test	38220090	24,500.00
CLS0730RA	Rat FMS-like tyrosine kinase 1,Flt1 ELISA Kit	96 Test	38220090	24,500.00
CLS0731RA	Rat Beclin1,BECN1 ELISA kit	96 Test	38220090	24,500.00
CLS0732RA	Rat Carboxyhemoglobin,HbCO ELISA Kit	96 Test	38220090	24,500.00
CLS0733RA	Rat Chitinase-3-like Protein 1(YKL-40/CHI3L1)ELISA Kit	96 Test	38220090	24,500.00
CLS0734RA	Rat Hormone sensitive lipase(HSL)ELISA Kit	96 Test	38220090	24,500.00
CLS0735RA	Rat Acetyl-Coa Carboxylase1(ACC1) ELISA Kit	96 Test	38220090	24,500.00
CLS0736RA	Rat Fructose-1,6-bisphosphatase 1,FBP1 ELISA kit	96 Test	38220090	24,500.00
CLS0737RA	Rat N-methyl-d-aspartic acid,NMDA ELISA Kit	96 Test	38220090	24,500.00
CLS0738RA	Rat Gonadotropin-inhibitory hormone,GnIH ELISA Kit	96 Test	38220090	24,500.00
CLS0739RA	Rat Glucose Transporter 2 (GLUT2)ELISA kit	96 Test	38220090	24,500.00
CLS0740RA	Rat Mesencephalic astrocyte-derived neurotrophic factor,MANF ELISA Kit	96 Test	38220090	24,500.00
CLS0741RA	Rat Fructosamine,FTA ELISA kit	96 Test	38220090	24,500.00
CLS0742RA	Rat GRB2-related adapter protein 2(GRAP2/P38) ELISA Kit	96 Test	38220090	24,500.00
CLS0743RA	Rat mitogen activated protein kinase1,MAPK1/MAPK ELISA Kit	96 Test	38220090	24,500.00
CLS0744RA	Rat glucokinase,GCK ELISA Kit	96 Test	38220090	24,500.00
CLS0745RA	Rat Glucose-6-phosphate isomerase,GPI ELISA Kit	96 Test	38220090	24,500.00
CLS0746RA	Rat Fibroblast growth factor 6,FGF6 ELISA Kit	96 Test	38220090	24,500.00
CLS0747RA	Rat Gastrin,GAS ELISA Kit	96 Test	38220090	24,500.00
CLS0748RA	Rat Alpha-Synuclein,SNCA ELISA Kit	96 Test	38220090	24,500.00
CLS0749RA	Rat Interleukin 25,IL-25 ELISA Kit	96 Test	38220090	24,500.00
CLS0750RA	Rat Annexin A1 (ANXA1)ELISA Kit	96 Test	38220090	24,500.00
CLS0751RA	Rat Kallikrein 6,KLK6 ELISA Kit	96 Test	38220090	24,500.00
CLS0752RA	Rat Lipoxin A4,LXA4 ELISA Kit	96 Test	38220090	24,500.00
CLS0753RA	Rat Carbohydrate Antigen 15-3 (CA15-3)ELISA kit	96 Test	38220090	24,500.00
CLS0754RA	Rat Glutamate oxaloacetate transaminase 1,GOT1 ELISA Kit	96 Test	38220090	24,500.00
CLS0755RA	Rat NAD-dependent protein deacetylase sirtuin-1 (SIRT1)ELISA Kit	96 Test	38220090	24,500.00
CLS0756RA	Rat α -Amylase,AMS/AMY ELISA Kit	96 Test	38220090	24,500.00
CLS0757RA	Rat connective tissue-activating peptide III,CTAP III ELISA Kit	96 Test	38220090	24,500.00
CLS0758RA	Rat mammary derived growth inhibitor,MDGI ELISA Kit	96 Test	38220090	24,500.00
CLS0759RA	Rat platelet membrane glycoprotein I bIX α ,GP- I bIX α ELISA Kit	96 Test	38220090	24,500.00
CLS0760RA	Rat lymphocyte function associated antigen 2,LFA-2 ELISA Kit	96 Test	38220090	24,500.00
CLS0761RA	Rat soluble vascular endothelial growth factor receptor-3, sVEGFR-3/sFLT-4 ELISA Kit	96 Test	38220090	24,500.00
CLS0762RA	Rat soluble cluster of differentiation 44 variant 9,sCD44-v9 ELISA Kit	96 Test	38220090	24,500.00
CLS0763RA	Rat Follistatin-related protein 4(FSTL4)ELISA Kit	96 Test	38220090	24,500.00
CLS0764RA	Rat Dual Specificity Phosphatase 6 (DUSP6)ELISA Kit	96 Test	38220090	24,500.00
CLS0765RA	Rat Orosomuroid 1,ORM1 ELISA Kit	96 Test	38220090	24,500.00
CLS0766RA	Rat Total Testosteron,Total-T ELISA Kit	96 Test	38220090	24,500.00
CLS0767RA	Rat Angiotensin III,ANG-III ELISA Kit	96 Test	38220090	24,500.00
CLS0768RA	Rat Angiotensin IV,ANG-IV ELISA Kit	96 Test	38220090	24,500.00
CLS0769RA	Rat Angiotensin 1-7 (Ang1-7) ELISA Kit	96 Test	38220090	24,500.00
CLS0770RA	Rat Adipose Triglyceride Lipase(ATGL)ELISA Kit	96 Test	38220090	24,500.00
CLS0771RA	Rat Progranulin(PGRN)ELISA Kit	96 Test	38220090	24,500.00
CLS0772RA	Rat NADPH oxidase 4(NOX4)ELISA Ki	96 Test	38220090	24,500.00
CLS0773RA	Rat 1,3- β D glucosidase,1,3- β D-Glu ELISA Kit	96 Test	38220090	24,500.00
CLS0774RA	Rat 17-Hydroxycorticosteroids,17-OHCS ELISA Kit	96 Test	38220090	24,500.00
CLS0775RA	Rat 17-Hydroxyprogesterone,17-OHP ELISA Kit	96 Test	38220090	24,500.00
CLS0776RA	Rat 17-ketosteroids,17-KS ELISA Kit	96 Test	38220090	24,500.00

Cat.No.	Product Description	Pack Size	HSN	Unit Price
CLS0777RA	Rat cross-linked C-telopeptides of Type I collagen, C I CP ELISA Kit	96 Test	38220090	24,500.00
CLS0778RA	Rat 26S proteasome, 26S PSM ELISA Kit	96 Test	38220090	24,500.00
CLS0779RA	Rat procollagen III N-terminal peptide, PIII NT ELISA Kit	96 Test	38220090	24,500.00
CLS0780RA	Rat Collagen Type IV, Col IV ELISA KIT	96 Test	38220090	24,500.00
CLS0781RA	Rat 5-lipoxygenase, 5-LO/LOX ELISA Kit	96 Test	38220090	24,500.00
CLS0782RA	Rat 6-keto-prostaglandin, 6-K-PG ELISA Kit	96 Test	38220090	24,500.00
CLS0783RA	Rat 6-keto-prostaglandin F1a, 6-K-PGF1a ELISA Kit	96 Test	38220090	24,500.00
CLS0784RA	Rat 8-oxoguanine DNA glycosylase, OGG ELISA Kit	96 Test	38220090	24,500.00
CLS0785RA	Rat 8-iso prostaglandin (8-iso-PG) ELISA Kit	96 Test	38220090	24,500.00
CLS0786RA	Rat factor B, BF ELISA Kit	96 Test	38220090	24,500.00
CLS0787RA	Rat CCAAT/enhancer binding protein beta, C/EBPβ ELISA Kit	96 Test	38220090	24,500.00
CLS0788RA	Rat Cluster of differentiation 30, CD30 ELISA Kit	96 Test	38220090	24,500.00
CLS0789RA	Rat Cluster of differentiation 3, CD3 ELISA Kit	96 Test	38220090	24,500.00
CLS0790RA	Rat cluster Of differentiation, CD4 ELISA Kit	96 Test	38220090	24,500.00
CLS0791RA	Rat cluster of differentiation 8, CD8 ELISA Kit	96 Test	38220090	24,500.00
CLS0792RA	Rat c-Jun N-terminal kinases/stress-activated protein kinase, JNK/SAPK ELISA Kit	96 Test	38220090	24,500.00
CLS0793RA	Rat CXC-chemokine ligand 16, CXCL16 ELISA Kit	96 Test	38220090	24,500.00
CLS0794RA	Rat CXC-chemokine receptor 3, CXCR3 ELISA Kit	96 Test	38220090	24,500.00
CLS0795RA	Rat C-type natriuretic peptide, CNP ELISA Kit	96 Test	38220090	24,500.00
CLS0796RA	Rat Epithelial-Cadherin, E-Cad ELISA Kit	96 Test	38220090	24,500.00
CLS0797RA	Rat FMS-like tyrosine kinase 3, Flt3 ELISA Kit	96 Test	38220090	24,500.00
CLS0798RA	Rat FMS-like tyrosine kinase 3 ligand, Flt-3L ELISA Kit	96 Test	38220090	24,500.00
CLS0799RA	Rat GATA binding protein 4, GATA4 ELISA Kit	96 Test	38220090	24,500.00
CLS0800RA	Rat Inhibitor of KB kinase, IKK ELISA Kit	96 Test	38220090	24,500.00
CLS0801RA	Rat Ki-67 protein, ki67P ELISA kit	96 Test	38220090	24,500.00
CLS0802RA	Rat L-Phenylalanine ammonia-lyase, PAL ELISA Kit	96 Test	38220090	24,500.00
CLS0803RA	Rat L-Lactate Dehydrogenase, L-LDH ELISA Kit	96 Test	38220090	24,500.00
CLS0804RA	Rat leukocyte Selectin, L-Selectin ELISA kit	96 Test	38220090	24,500.00
CLS0805RA	Rat N-Acetyl-Ser-Asp-Lys-Pro, AcSDKP ELISA Kit	96 Test	38220090	24,500.00
CLS0806RA	Rat p16 ELISA Kit	96 Test	38220090	24,500.00
CLS0807RA	Rat Soluble protein-100, S-100 ELISA Kit	96 Test	38220090	24,500.00
CLS0808RA	Rat Mothers against decapentaplegic homolog 1, Smad1 ELISA Kit	96 Test	38220090	24,500.00
CLS0809RA	Rat Mothers against decapentaplegic homolog 7, Smad7 ELISA Kit	96 Test	38220090	24,500.00
CLS0810RA	Rat TGF-beta-inducible early response gene-1, TIEG1 ELISA Kit	96 Test	38220090	24,500.00
CLS0811RA	Rat Toll-like receptor 3, TLR3 ELISA Kit	96 Test	38220090	24,500.00
CLS0812RA	Rat Toll-like receptor 9, TLR-9 ELISA kit	96 Test	38220090	24,500.00
CLS0813RA	Rat X-linked inhibitor of apoptosis protein · XIAP ELISA Kit	96 Test	38220090	24,500.00
CLS0814RA	Rat α1-microglobulin, α1-MG ELISA Kit	96 Test	38220090	24,500.00
CLS0815RA	Rat alpha-L-fucosidase, AFU ELISA Kit	96 Test	38220090	24,500.00
CLS0816RA	Rat α-Glucosidase, α-Glu ELISA Kit	96 Test	38220090	24,500.00
CLS0817RA	Rat β2-glycoprotein 1 antibody IgA/G/M, β2-GP1 IgA/G/M ELISA Kit	96 Test	38220090	24,500.00
CLS0818RA	Rat cytokeratin 17, CK-17 ELISA Kit	96 Test	38220090	24,500.00
CLS0819RA	Rat Beta-Endorphin receptor, β-EPR ELISA Kit	96 Test	38220090	24,500.00
CLS0820RA	Rat β-Defensins, β-DF ELISA Kit	96 Test	38220090	24,500.00
CLS0821RA	Rat beta-site APP-cleaving enzyme 2, BACE2 ELISA Kit	96 Test	38220090	24,500.00
CLS0822RA	Rat beta cellulin, BTC ELISA Kit	96 Test	38220090	24,500.00
CLS0823RA	Rat interferony-inducible protein 16, IFI16/P16 ELISA Kit	96 Test	38220090	24,500.00
CLS0824RA	Rat iduronate sulfatase, IDS ELISA Kit	96 Test	38220090	24,500.00
CLS0825RA	Rat Interleukin 15, IL-15 ELISA KIT	96 Test	38220090	24,500.00
CLS0826RA	Rat Interleukin 16, IL-16 ELISA KIT	96 Test	38220090	24,500.00
CLS0827RA	Rat soluble interleukin-1 receptor I, IL-1sR I ELISA kit	96 Test	38220090	24,500.00

Cat.No.	Product Description	Pack Size	HSN	Unit Price
CLS0828RA	Rat soluble interleukin-1 receptor II,IL-1sRII ELISA kit	96 Test	38220090	24,500.00
CLS0829RA	Rat soluble Interleukin 2 receptor,IL-2sR ELISA Kit	96 Test	38220090	24,500.00
CLS0830RA	Rat Interleukin-7,IL-7 ELISA kit	96 Test	38220090	24,500.00
CLS0831RA	Rat asymmetrical dimethylarginine,ADMA ELISA kit	96 Test	38220090	24,500.00
CLS0832RA	Rat Leukotriene C4,LT-C4 ELISA Kit	96 Test	38220090	24,500.00
CLS0833RA	Rat leukotriene E4,LT-E4 ELISA Kit	96 Test	38220090	24,500.00
CLS0834RA	Rat Activated Leukocyte Cell Adhesion Molecule,ALCAM ELISA Kit	96 Test	38220090	24,500.00
CLS0835RA	Rat leukemia inhibitory factor receptor,LIFR ELISA Kit	96 Test	38220090	24,500.00
CLS0836RA	Rat cysteinyl aspartate specific proteinases 12,Caspase- 12 ELISA Kit	96 Test	38220090	24,500.00
CLS0837RA	Rat cysteinyl leukotrienes,CysLTs ELISA Kit	96 Test	38220090	24,500.00
CLS0838RA	Rat Bladder tumor antigen,BTA ELISA Kit	96 Test	38220090	24,500.00
CLS0839RA	Rat Cytosolic Phospholipase A2,cPLA2 ELISA Kit	96 Test	38220090	24,500.00
CLS0840RA	Rat pyridinium crosslink/PyriLinks,PY ELISA Kit	96 Test	38220090	24,500.00
CLS0841RA	Rat pyruvate dehydrogenase-E1,PDH E1 ELISA Kit	96 Test	38220090	24,500.00
CLS0842RA	Rat complement factor H,CFH ELISA Kit	96 Test	38220090	24,500.00
CLS0843RA	Rat forkhead box P3,Foxp3 ELISA Kit	96 Test	38220090	24,500.00
CLS0844RA	Rat very late appearing antigen ,VLA ELISA Kit	96 Test	38220090	24,500.00
CLS0845RA	Rat very late appearing antigen 4,VLA4 ELISA Kit	96 Test	38220090	24,500.00
CLS0846RA	rat Estradiol receptor,ER ELISA Kit	96 Test	38220090	24,500.00
CLS0847RA	Rat Estrogen Receptor,ER ELISA Kit	96 Test	38220090	24,500.00
CLS0848RA	Rat Estriol,E3 ELISA Kit	96 Test	38220090	24,500.00
CLS0849RA	rat growth hormone releasing hormone,GHRH ELISA Kit	96 Test	38220090	24,500.00
CLS0850RA	Rat anti-gonadotropin-releasing hormone receptor antibody,GNRHR-Ab ELISA Kit	96 Test	38220090	24,500.00
CLS0851RA	Rat Big Endothelin,Big ET ELISA Kit	96 Test	38220090	24,500.00
CLS0852RA	Rat monocyte chemotactic protein 3,MCP-3 ELISA kit	96 Test	38220090	24,500.00
CLS0853RA	Rat cholest erolester transfer protein,CETP ELISA Kit	96 Test	38220090	24,500.00
CLS0854RA	Rat Protein Kinase C alpha,PKCα ELISA Kit	96 Test	38220090	24,500.00
CLS0855RA	Rat protein kinase K9,PKK9 ELISA Kit	96 Test	38220090	24,500.00
CLS0856RA	Rat Protein Phosphatase,PP ELISA Kit	96 Test	38220090	24,500.00
CLS0857RA	Rat rudimental BSA checkup ELISA Kit	96 Test	38220090	24,500.00
CLS0858RA	Rat Low density lipoprotein immune complexes,LDL-IC ELISA Kit	96 Test	38220090	24,500.00
CLS0859RA	Rat low-density lipoprotein-receptor-related protein,LRP-1 ELISA Kit	96 Test	38220090	24,500.00
CLS0860RA	Rat Factor VIII-related Antigen,FVIII _{Ag} ELISA Kit	96 Test	38220090	24,500.00
CLS0861RA	Rat muscarinic acetylcholine receptor,M-AChR ELISA Kit	96 Test	38220090	24,500.00
CLS0862RA	Rat telomerase,TE ELISA Kit	96 Test	38220090	24,500.00
CLS0863RA	Rat dopamine D2 receptor,D2R ELISA Kit	96 Test	38220090	24,500.00
CLS0864RA	Rat Poly ADP ribose polymerase,PARP ELISA Kit	96 Test	38220090	24,500.00
CLS0865RA	Rat Defensins 5,D-5 ELISA KIT	96 Test	38220090	24,500.00
CLS0866RA	Rat obestatin ELISA KIT	96 Test	38220090	24,500.00
CLS0867RA	Rat Pulmonary surfatcant-associated protein B,SP-B ELISA Ki	96 Test	38220090	24,500.00
CLS0868RA	Rat Pulmonary surfatcant-associated protein C,SP-C ELISA Ki	96 Test	38220090	24,500.00
CLS0869RA	Rat secreted phospholipase A2,sPLA2 ELISA Kit	96 Test	38220090	24,500.00
CLS0870RA	Rat secretory leukocyte protease inhibitor,SLPI ELISA Kit	96 Test	38220090	24,500.00
CLS0871RA	Rat complex edprostate specific antigen,cPSA ELISA Kit	96 Test	38220090	24,500.00
CLS0872RA	Rat calcium/calmodulin-dependent protein kinase-II ,CAMK 2 ELISA Kit	96 Test	38220090	24,500.00
CLS0873RA	Rat calcineurin,CaN ELISA Kit	96 Test	38220090	24,500.00
CLS0874RA	Rat calmodulin,CAM ELISA Kit	96 Test	38220090	24,500.00
CLS0875RA	Rat Calretinin,CR ELISA Kit	96 Test	38220090	24,500.00
CLS0876RA	Rat Stem cell factor/mast cell growth factor,SCF/MGF ELISA kit	96 Test	38220090	24,500.00
CLS0877RA	Rat Stem Cell Factor Receptor,SCFR ELISA kit	96 Test	38220090	24,500.00

Cat.No.	Product Description	Pack Size	HSN	Unit Price
CLS0878RA	Rat galanin,GAL ELISA Kit	96 Test	38220090	24,500.00
CLS0879RA	Rat mannan binding lectin associated serine protease,MASP ELISA Kit	96 Test	38220090	24,500.00
CLS0880RA	Rat heparin-binding epidermal growth factor-like growth factor,HB-EGF ELISA Kit	96 Test	38220090	24,500.00
CLS0881RA	Rat Ultrasensitivity Thyroxine,u-T4 ELISA Kit	96 Test	38220090	24,500.00
CLS0882RA	Rat Leptospira IgG,Lep IgG ELISA Kit	96 Test	38220090	24,500.00
CLS0883RA	Rat orphanin FQ/nociceptin,OFQ/N ELISA Kit	96 Test	38220090	24,500.00
CLS0884RA	Rat glutamic acid decarboxylase autoantibody,GAD-Ab ELISA Kit	96 Test	38220090	24,500.00
CLS0885RA	Rat Osteoprotegerin Ligand,OPGL ELISA Kit	96 Test	38220090	24,500.00
CLS0886RA	Rat Bone morphogenetic protein 4,BMP-4 ELISA Kit	96 Test	38220090	24,500.00
CLS0887RA	Rat Bone morphogenetic protein 7,BMP-7 ELISA Kit	96 Test	38220090	24,500.00
CLS0888RA	Rat Bone morphogenetic protein receptor 1A, BMPR-1A ELISA Kit	96 Test	38220090	24,500.00
CLS0889RA	Rat Crosslaps,Cr ELISA Kit	96 Test	38220090	24,500.00
CLS0890RA	Rat bone morphogenetic proteins,BMPs ELISA Kit	96 Test	38220090	24,500.00
CLS0891RA	Rat osteonectin,ON ELISA Kit	96 Test	38220090	24,500.00
CLS0892RA	Rat cysteinyl aspartate specific proteinases 12,Caspase-12 ELISA Kit	96 Test	38220090	24,500.00
CLS0893RA	Rat tyrosine kinase with immunoglobulin-like and EGF-like domains 2,Tie-2 ELISA kit	96 Test	38220090	24,500.00
CLS0894RA	Rat melanocyte antibody,MC Ab ELISA Kit	96 Test	38220090	24,500.00
CLS0895RA	Rat skeletal muscle Actinin- α ,sm Actinin- α ELISA Kit	96 Test	38220090	24,500.00
CLS0896RA	Rat Erythropoietin receptor,EPOR ELISA Kit	96 Test	38220090	24,500.00
CLS0897RA	Rat Transthyretin,TTR ELISA Kit	96 Test	38220090	24,500.00
CLS0898RA	Rat activated protein C,APC ELISA Kit	96 Test	38220090	24,500.00
CLS0899RA	Rat Activin A,ACV-A ELISA Kit	96 Test	38220090	24,500.00
CLS0900RA	Rat anti-Activin A receptor antibody,ACV-RAb ELISA Kit	96 Test	38220090	24,500.00
CLS0901RA	Rat Myosin,MYS ELISA Kit	96 Test	38220090	24,500.00
CLS0902RA	Rat myosin light chain kinase,MLCK ELISA Kit	96 Test	38220090	24,500.00
CLS0903RA	Rat matrix metalloproteinase 10,MMP-10 ELISA kit	96 Test	38220090	24,500.00
CLS0904RA	Rat matrix metalloproteinase 4,MMP-4 ELISA Kit	96 Test	38220090	24,500.00
CLS0905RA	Rat matrix metalloproteinase 5,MMP-5 ELISA Kit	96 Test	38220090	24,500.00
CLS0906RA	Rat tissue inhibitors of metalloproteinase 3,TIMP-3 ELISA Kit	96 Test	38220090	24,500.00
CLS0907RA	Rat matrilysin,MAT ELISA Kit	96 Test	38220090	24,500.00
CLS0908RA	Rat Stromal cell derived factor 1 β ,SDF-1 β ELISA Kit	96 Test	38220090	24,500.00
CLS0909RA	Rat Kallikrein 10,KLK10 ELISA Kit	96 Test	38220090	24,500.00
CLS0910RA	Rat Methylase ELISA Kit	96 Test	38220090	24,500.00
CLS0911RA	Rat Parathyroid Hormone Related Protein,PTHrP ELISA Ki	96 Test	38220090	24,500.00
CLS0912RA	Rat Thyroglobulin,TG ELISA Kit	96 Test	38220090	24,500.00
CLS0913RA	Rat Thyroxine antibody,TAb ELISA Kit	96 Test	38220090	24,500.00
CLS0914RA	Rat Normetanephrine ,NMN ELISA Kit	96 Test	38220090	24,500.00
CLS0915RA	Rat metanephrine,MN ELISA Kit	96 Test	38220090	24,500.00
CLS0916RA	Rat basic fibroblast growth factor 4,bFGF-4 ELISA Kit	96 Test	38220090	24,500.00
CLS0917RA	Rat basic fibroblast growth factor 6,bFGF-6 ELISA Kit	96 Test	38220090	24,500.00
CLS0918RA	Rat basic fibroblast growth factor 9,bFGF-9 ELISA Kit	96 Test	38220090	24,500.00
CLS0919RA	Rat Collagenase Type II ELISA Kit	96 Test	38220090	24,500.00
CLS0920RA	Rat keratinocyte autocrine factor/Amphiregulin, KAF/AR ELISA Kit	96 Test	38220090	24,500.00
CLS0921RA	Rat Keratinocyte Growth Factor,KGF ELISA Kit	96 Test	38220090	24,500.00
CLS0922RA	Rat Caveolin-1,Cav-1 ELISA KIT	96 Test	38220090	24,500.00
CLS0923RA	Rat Desmin,Des ELISA Kit	96 Test	38220090	24,500.00
CLS0924RA	Rat Ciliary Neurotrophic Factor,CNTF ELISA Kit	96 Test	38220090	24,500.00
CLS0925RA	Rat A Disintegrin And Metalloprotease 8,ADAM8 ELISA Kit	96 Test	38220090	24,500.00
CLS0926RA	Rat A Disintegrin And Metalloprotease 9,ADAM9 ELISA Kit	96 Test	38220090	24,500.00
CLS0927RA	Rat arginine,Arg ELISA Kit	96 Test	38220090	24,500.00

Cat.No.	Product Description	Pack Size	HSN	Unit Price
CLS0928RA	Rat Macrophage-Derived Chemokine,MDC ELISA kit	96 Test	38220090	24,500.00
CLS0929RA	Rat Alternative macrophage activation-associated CC chemokine 1,AMAC-1 ELISA Kit	96 Test	38220090	24,500.00
CLS0930RA	Rat macrophage inflammatory protein 3 α ,MIP-3 α ELISA Kit	96 Test	38220090	24,500.00
CLS0931RA	Rat macrophage inflammatory protein 3 β ,MIP-3 β ELISA kit	96 Test	38220090	24,500.00
CLS0932RA	Rat macrophage inflammatory protein 5,MIP-5 ELISA Kit	96 Test	38220090	24,500.00
CLS0933RA	Rat Macrophage Migration Inhibitory Factor,MIF ELISA Kit	96 Test	38220090	24,500.00
CLS0934RA	Rat anti-IgE receptor antibody ELISA Kit	96 Test	38220090	24,500.00
CLS0935RA	Rat anti-IVIgG antibody ELISA Kit	96 Test	38220090	24,500.00
CLS0936RA	Rat anti-alpha-Fodrin IgG/IgA, α -Fodrin IgG/IgA ELISA Kit	96 Test	38220090	24,500.00
CLS0937RA	Rat thyroid stimulating hormone receptor antibody,TRAb ELISA Kit	96 Test	38220090	24,500.00
CLS0938RA	Rat anti-Monocyte antibody,AMA ELISA Kit	96 Test	38220090	24,500.00
CLS0939RA	Rat Anti-glucoprotein 210,GP210 ELISA Kit	96 Test	38220090	24,500.00
CLS0940RA	Rat anti-red cell antibody ELISA Kit	96 Test	38220090	24,500.00
CLS0941RA	Rat anti-Thyroid-Peroxidase antibody,TPO-Ab ELISA Kit	96 Test	38220090	24,500.00
CLS0942RA	Rat Anti-thyroid-globulin antibody,ATGA/TGAB ELISA KIT	96 Test	38220090	24,500.00
CLS0943RA	Rat anti-endothelial cell antibody,AECA ELISA Kit	96 Test	38220090	24,500.00
CLS0944RA	Rat Anti-Thrombin III,AT-III ELISA Kit	96 Test	38220090	24,500.00
CLS0945RA	Rat anti-thrombin receptor,ATR ELISA Kit	96 Test	38220090	24,500.00
CLS0946RA	Rat Anti-Smooth Muscle Antibody,ASMA ELISA Kit	96 Test	38220090	24,500.00
CLS0947RA	Rat anti-double stranded DNA,dsDNA ELISA KIT	96 Test	38220090	24,500.00
CLS0948RA	Rat anti-myelin associated glycoprotein antibody,MAG Ab ELISA Kit	96 Test	38220090	24,500.00
CLS0949RA	Rat Anti-myocardial antibody,AMA ELISA Kit	96 Test	38220090	24,500.00
CLS0950RA	Rat anti-cardiolipin antibody IgA,ACA-IgA ELISA Kit	96 Test	38220090	24,500.00
CLS0951RA	Rat anti-cardiolipin antibody IgG,ACA-IgG ELISA Kit	96 Test	38220090	24,500.00
CLS0952RA	rat anti-cardiolipin antibody IgM,ACA-IgM ELISA Kit	96 Test	38220090	24,500.00
CLS0953RA	Rat platelet antibodies IgG/M/A,PA-IgG/M/A ELISA Kit	96 Test	38220090	24,500.00
CLS0954RA	Rat Anti-trypsin,AT ELISA Kit	96 Test	38220090	24,500.00
CLS0955RA	Rat anti-centrol and centrosome antibody,ACA ELISA Kit	96 Test	38220090	24,500.00
CLS0956RA	Rat Perinuclear anti-neutrophil cytoplasmic antibody,pANCA ELISA Kit	96 Test	38220090	24,500.00
CLS0957RA	Rat Endometrium Antibody,EMAb ELISA Kit	96 Test	38220090	24,500.00
CLS0958RA	Rat granzymes A,Gzms-A ELISA Kit	96 Test	38220090	24,500.00
CLS0959RA	Rat granzymes B,Gzms-B ELISA Kit	96 Test	38220090	24,500.00
CLS0960RA	Rat Soluble Cluster of differentiation 30 ligand,s CD30L ELISA Kit	96 Test	38220090	24,500.00
CLS0961RA	Rat soluble Cluster of differentiation 86,sCD86 ELISA Kit	96 Test	38220090	24,500.00
CLS0962RA	Rat soluble Interleukin 7 receptor,sIL-7R/CD127 ELISA Kit	96 Test	38220090	24,500.00
CLS0963RA	Rat soluble Factor-related Apoptosis,sFAS/Apo-1 ELISA Kit	96 Test	38220090	24,500.00
CLS0964RA	Rat soluble myosin heavy chain 1,sMHC-1 ELISA Kit	96 Test	38220090	24,500.00
CLS0965RA	Rat soluble vascular endothelial growth factor receptor-2,sVEGFR-2/sFLK-1 ELISA Kit	96 Test	38220090	24,500.00
CLS0966RA	Rat soluble endothelial protein C receptor,sEPCR ELISA Kit	96 Test	38220090	24,500.00
CLS0967RA	Rat soluble tumor necrosis factor-related apoptosis inducing ligand,sTRAIL ELISA KIT	96 Test	38220090	24,500.00
CLS0968RA	Rat Clara cell protein,CC16 ELISA Kit	96 Test	38220090	24,500.00
CLS0969RA	Rat trypase,TPS ELISA Kit	96 Test	38220090	24,500.00
CLS0970RA	Rat lymphocyte function associated antigen 3,LFA-3 ELISA Kit	96 Test	38220090	24,500.00
CLS0971RA	Rat lymphotactin,Lptn/LTN ELISA Kit	96 Test	38220090	24,500.00
CLS0972RA	Rat lymphocyte factor ELISA Kit	96 Test	38220090	24,500.00

Cat.No.	Product Description	Pack Size	HSN	Unit Price
CLS0973RA	Rat phospho-extracellular signal-regulated kinase,pERK ELISA Kit	96 Test	38220090	24,500.00
CLS0974RA	Rat Phosphorylated acetyl-CoA catboxylase, pACCase ELISA Kit	96 Test	38220090	24,500.00
CLS0975RA	Rat Phospholipidase A2,PL-A2 ELISA Kit	96 Test	38220090	24,500.00
CLS0976RA	Rat phospholipaseC, PLC ELISA Kit	96 Test	38220090	24,500.00
CLS0977RA	Rat phosphatidylinositol antibody IgG/IgM,PI Ab-IgG/IgM ELISA Kit	96 Test	38220090	24,500.00
CLS0978RA	Rat Phospholipase C,PLC ELISA Kit	96 Test	38220090	24,500.00
CLS0979RA	Rat Chondroitin Sulfate Epitope 3B3,CS3B3 ELISA Kt	96 Test	38220090	24,500.00
CLS0980RA	Rat Thioredoxin,Trx ELISA Kit	96 Test	38220090	24,500.00
CLS0981RA	Rat Follistatin,FS ELISA Kit	96 Test	38220090	24,500.00
CLS0982RA	Rat Annexin A2,Anxa2 ELISA Kit	96 Test	38220090	24,500.00
CLS0983RA	Rat Endothelin receptor A,ETR-A ELISA kit	96 Test	38220090	24,500.00
CLS0984RA	Rat Endothelin receptor B,ETR-B ELISA kit	96 Test	38220090	24,500.00
CLS0985RA	Rat Vascular adhesion protein-1,VAP-1/AOC3 ELISA Kit	96 Test	38220090	24,500.00
CLS0986RA	Rat Endostatin,ES ELISA Kit	96 Test	38220090	24,500.00
CLS0987RA	Rat Endothelial lipase,EL ELISA Kit	96 Test	38220090	24,500.00
CLS0988RA	Rat urokinase,UK ELISA Kit	96 Test	38220090	24,500.00
CLS0989RA	Rat urokinase plasminogen activator,uPA ELISA kit	96 Test	38220090	24,500.00
CLS0990RA	Rat Urea elisa kit	96 Test	38220090	24,500.00
CLS0991RA	Rat microalbuminuria,MAU/ALB ELISA Kit	96 Test	38220090	24,500.00
CLS0992RA	Rat Gelsolin ELISA Kit	96 Test	38220090	24,500.00
CLS0993RA	Rat thrombin-antithrombin complex,TAT ELISA Kit	96 Test	38220090	24,500.00
CLS0994RA	Rat thrombin receptor,TR ELISA Kit	96 Test	38220090	24,500.00
CLS0995RA	Rat coagulation factor II ,FII ELISA Kit	96 Test	38220090	24,500.00
CLS0996RA	Rat coagulation factor III ,FIII ELISA Kit	96 Test	38220090	24,500.00
CLS0997RA	Rat coagulation factor X III ,FX III ELISA Kit	96 Test	38220090	24,500.00
CLS0998RA	Rat coagulation factor XII ,FXII ELISA Kit	96 Test	38220090	24,500.00
CLS0999RA	Rat Calf Intestine Alkaline Phosphatase,CIAP ELISA Kit	96 Test	38220090	24,500.00
CLS1000RA	Rat osteoclast differentiation factor,ODF ELISA Kit	96 Test	38220090	24,500.00
CLS1001RA	Rat Prostaglandin F,PG-F ELISA Kit	96 Test	38220090	24,500.00
CLS1002RA	Rat Prostatic Acid Phosphatase,PAP ELISA Kit	96 Test	38220090	24,500.00
CLS1003RA	Rat Pro Atrial Natriuretic Peptide,Pro-ANP ELISA Kit	96 Test	38220090	24,500.00
CLS1004RA	Rat Hyaluronan synthase 2,HAS2 ELISA Kit	96 Test	38220090	24,500.00
CLS1005RA	Rat heat shock protein 20,hSP-20 ELISA Kit	96 Test	38220090	24,500.00
CLS1006RA	Rat heat shock protein 40,hSP-40 ELISA Kit	96 Test	38220090	24,500.00
CLS1007RA	Rat heat shock protein,HSP47 ELISA Kit	96 Test	38220090	24,500.00
CLS1008RA	Rat heat shock protein 60,hSP-60 ELISA Kit	96 Test	38220090	24,500.00
CLS1009RA	Rat Heat Shock Protein glycoprotein 96,HSP gp96 ELISA Kit	96 Test	38220090	24,500.00
CLS1010RA	Rat Heat Shock Factor 1,HSF1 ELISA Kit	96 Test	38220090	24,500.00
CLS1011RA	Rat pregnancy associated plasma protein A,PAPP-A ELISA Kit	96 Test	38220090	24,500.00
CLS1012RA	Rat Chorionic Gonadotrophin,CG ELISA Kit	96 Test	38220090	24,500.00
CLS1013RA	Rat carnitine-acylcarnitine translocase,CACT ELISA Kit	96 Test	38220090	24,500.00
CLS1014RA	Rat mammary carcinoma Marker-CA153 ELISA Kit	96 Test	38220090	24,500.00
CLS1015RA	Rat pigment epithelium-derived factor,PEDF ELISA Kit	96 Test	38220090	24,500.00
CLS1016RA	Rat Epithelial neutrophil activating peptide 78,ENA-78 ELISA Kit	96 Test	38220090	24,500.00
CLS1017RA	Rat Neurotrophin 4,NT-4 ELISA KIT	96 Test	38220090	24,500.00
CLS1018RA	Rat adrenergic alpha-1A receptor,ADRA1A ELISA Kit	96 Test	38220090	24,500.00
CLS1019RA	Rat Growth Hormone Releasing Peptide,GHRP ELISA Kit	96 Test	38220090	24,500.00
CLS1020RA	Rat Chromogranin-A,CgA ELISA Kit	96 Test	38220090	24,500.00
CLS1021RA	Rat DC specific intercellular adhesion molecule 3-grabbing nonintegrin,DC-SIGN/CD209 ELISA Kit	96 Test	38220090	24,500.00
CLS1022RA	Rat acidic isoform of ferritin, AIF ELISA Kit	96 Test	38220090	24,500.00
CLS1023RA	Rat Aquaporin 0,AQP-0 ELISA Kit	96 Test	38220090	24,500.00

Cat.No.	Product Description	Pack Size	HSN	Unit Price
CLS1024RA	Rat Aquaporin 1,AQP-1 ELISA Kit	96 Test	38220090	24,500.00
CLS1025RA	Rat Aquaporin 2,AQP-2 ELISA Kit	96 Test	38220090	24,500.00
CLS1026RA	Rat Aquaporin 3,AQP-3 ELISA Kit	96 Test	38220090	24,500.00
CLS1027RA	Rat Aquaporin 4,AQP-4 ELISA Kit	96 Test	38220090	24,500.00
CLS1028RA	Rat Aquaporin 5,AQP-5 ELISA Kit	96 Test	38220090	24,500.00
CLS1029RA	Rat serine/threonine protein kinase,STK ELISA Kit	96 Test	38220090	24,500.00
CLS1030RA	Rat acidic fibroblast growth factor 1,aFGF-1 ELISA Kit	96 Test	38220090	24,500.00
CLS1031RA	Rat myeloperoxidase-antineutrophil cytoplasmic antibody IgG,MPO-ANCA IgG ELISA kit	96 Test	38220090	24,500.00
CLS1032RA	Rat myelin basic protein,MBP ELISA Kit	96 Test	38220090	24,500.00
CLS1033RA	Rat myelin basic protein autoantibody,MBP ELISA Kit	96 Test	38220090	24,500.00
CLS1034RA	Rat Triggering Receptor Expresses on Myeloid Cells-1,TREM-1 ELISA Kit	96 Test	38220090	24,500.00
CLS1035RA	Rat carbonic anhydrase 2,CA-2 ELISA Kit	96 Test	38220090	24,500.00
CLS1036RA	Rat glucocorticoid receptor-β,GR-β ELISA Kit	96 Test	38220090	24,500.00
CLS1037RA	Rat glycogen synthase kinase,GSK ELISA Kit	96 Test	38220090	24,500.00
CLS1038RA	Rat Glycogen phosphorylase BB,GP-BB ELISA Kit	96 Test	38220090	24,500.00
CLS1039RA	Rat Glycogen phosphorylase II,GP-II ELISA Kit	96 Test	38220090	24,500.00
CLS1040RA	Rat Glycogen phosphorylase MM,GP-MM ELISA Kit	96 Test	38220090	24,500.00
CLS1041RA	Rat specific Immunoglobulin E,slgE ELISA Kit	96 Test	38220090	24,500.00
CLS1042RA	Rat Hya]uronate binding protein,HABP ELISA Kit	96 Test	38220090	24,500.00
CLS1043RA	Rat Dehydroepiandrosterone S7,DHEA-S7 ELISA Kit	96 Test	38220090	24,500.00
CLS1044RA	Rat Dehydroepiandrosterone sulfate,DHEA-S ELISA Kit	96 Test	38220090	24,500.00
CLS1045RA	Rat Gastrointestinalcancer Marker-CA199 ELISA Kit	96 Test	38220090	24,500.00
CLS1046RA	Rat Motilin,MTL ELISA Kit	96 Test	38220090	24,500.00
CLS1047RA	Rat Pentosidine ELISA Kit	96 Test	38220090	24,500.00
CLS1048RA	Rat intercellular adhesion molecule 3,ICAM-3 ELISA Kit	96 Test	38220090	24,500.00
CLS1049RA	Rat cytovillin/ezrin,CVL ELISA Kit	96 Test	38220090	24,500.00
CLS1050RA	Rat G1/S-specific Cyclin-D1,Cyclin-D1 ELISA Kit	96 Test	38220090	24,500.00
CLS1051RA	Rat Cyclin-D2 ELISA Kit	96 Test	38220090	24,500.00
CLS1052RA	Rat Cyclin-D3 ELISA Kit	96 Test	38220090	24,500.00
CLS1053RA	Rat Apolipoprotein M,Apo-M ELISA Kit	96 Test	38220090	24,500.00
CLS1054RA	Rat Thrombin activatable fibrinolysis inhibitor,TAFI ELISA Kit	96 Test	38220090	24,500.00
CLS1055RA	Rat cardiac isoform of Troponin T,cTnT ELISA Kit	96 Test	38220090	24,500.00
CLS1056RA	Rat cardiostrophin 1,CT-1 ELISA Kit	96 Test	38220090	24,500.00
CLS1057RA	Rat Neonatal Thyroxine,NN-T4 ELISA Kit	96 Test	38220090	24,500.00
CLS1058RA	Rat thymus activation regulated chemokine,TARC ELISA Kit	96 Test	38220090	24,500.00
CLS1059RA	Rat thymic stromal lymphopoietin,TSLP ELISA Kit	96 Test	38220090	24,500.00
CLS1060RA	Rat androgen ELISA Kit	96 Test	38220090	24,500.00
CLS1061RA	Rat Androstenedione,ASD ELISA Kit	96 Test	38220090	24,500.00
CLS1062RA	Rat Angiotensin I Converting Enzyme,ACE I ELISA Kit	96 Test	38220090	24,500.00
CLS1063RA	Rat Transferrin(TRF)ELISA Kit	96 Test	38220090	24,500.00
CLS1064RA	Rat Angiopoietin 4,ANG-4 ELISA Kit	96 Test	38220090	24,500.00
CLS1065RA	Rat tyrosine kinase with immunoglobulin-like and EGF-like domains 1,Tie1 ELISA kit	96 Test	38220090	24,500.00
CLS1066RA	Rat tyrosine kinase with immunoglobulin-like and EGF-like domains 2,Tie2 ELISA kit	96 Test	38220090	24,500.00
CLS1067RA	Rat von Willebrand Factor cleaving protease,ADAMTS-13/vWF-cp ELISA Kit	96 Test	38220090	24,500.00
CLS1068RA	Rat alpha-granular membrane protein,GMP-140 ELISA Kit	96 Test	38220090	24,500.00
CLS1069RA	Rat Urocortin,UCN LISA Kit	96 Test	38220090	24,500.00
CLS1070RA	Rat thrombomodulin,TM ELISA Kit	96 Test	38220090	24,500.00
CLS1071RA	Rat thrombus precursor protein,TpP ELISA Kit	96 Test	38220090	24,500.00
CLS1072RA	Rat platelet activating factor,PAF ELISA KIT	96 Test	38220090	24,500.00
CLS1073RA	Rat platelet membrane glycoprotein II bIII a,GP-II bIII a ELISA Kit	96 Test	38220090	24,500.00

Cat.No.	Product Description	Pack Size	HSN	Unit Price
CLS1074RA	Rat Thrombopoietin,TPO ELISA kit	96 Test	38220090	24,500.00
CLS1075RA	Rat platelet-derived growth factor-BB,PDGF-BB ELISA Kit	96 Test	38220090	24,500.00
CLS1076RA	Rat Platelet-Derived Growth Factor Soluble Receptor α ,PDGFsR- α ELISA kit	96 Test	38220090	24,500.00
CLS1077RA	Rat platelet factor 3, PF3 ELISA Kit	96 Test	38220090	24,500.00
CLS1078RA	Rat Platelet Factor 4,PF-4 ELISA Kit	96 Test	38220090	24,500.00
CLS1079RA	Rat oxidized lowdensity lipoprotein antibody,OLAb ELISA Kit	96 Test	38220090	24,500.00
CLS1080RA	Rat oxidosqualene cyclase,OSC ELISA Kit	96 Test	38220090	24,500.00
CLS1081RA	Rat Folic acid,FA ELISA Kit	96 Test	38220090	24,500.00
CLS1082RA	Rat nitric oxide synthase,NOS ELISA Kit	96 Test	38220090	24,500.00
CLS1083RA	Rat Insulin-like growth factor 2,IGF-2 ELISA Kit	96 Test	38220090	24,500.00
CLS1084RA	Rat Insulin-like growth factor binding protein 2,IGFBP-2 ELISA kit	96 Test	38220090	24,500.00
CLS1085RA	Rat Insulin-like growth factor binding protein 3,IGFBP-3 ELISA kit	96 Test	38220090	24,500.00
CLS1086RA	Rat Insulin-like growth factor binding protein 4,IGFBP-4 ELISA kit	96 Test	38220090	24,500.00
CLS1087RA	Rat insulin autoantibodies,IAA ELISA Kit	96 Test	38220090	24,500.00
CLS1088RA	Rat islet cell antibody,ICA ELISA Kit	96 Test	38220090	24,500.00
CLS1089RA	Rat Amylin ELISA Kit	96 Test	38220090	24,500.00
CLS1090RA	Rat aldehyde dehydrogenase,ALDH ELISA Kit	96 Test	38220090	24,500.00
CLS1091RA	Rat Oncostatin-M,OSM ELISA KIT	96 Test	38220090	24,500.00
CLS1092RA	Rat Inhibin,INH-A ELISA Kit	96 Test	38220090	24,500.00
CLS1093RA	Rat Inhibin binding protein,INHBP ELISA Kit	96 Test	38220090	24,500.00
CLS1094RA	Rat indoleamine 2,3-dioxygenase,IDO ELISA Kit	96 Test	38220090	24,500.00
CLS1095RA	Rat Helicobacter pylori IgG,Hp-IgG ELISA Kit	96 Test	38220090	24,500.00
CLS1096RA	Rat free cholesterol,fCHOL ELISA kit	96 Test	38220090	24,500.00
CLS1097RA	Rat dextralactic acid,D-La ELISA Kit	96 Test	38220090	24,500.00
CLS1098RA	Rat Progesterone receptor,PGR ELISA	96 Test	38220090	24,500.00
CLS1099RA	Rat regenerating gene IV,REG-4 ELISA Kit	96 Test	38220090	24,500.00
CLS1100RA	Rat tenascin,TN ELISA Kit	96 Test	38220090	24,500.00
CLS1101RA	Rat tenascin-C,TN-c ELISA Kit	96 Test	38220090	24,500.00
CLS1102RA	Rat regulated on activation in normal T-cell expressed and secreted/C-C motif chemokine 5(RANTES/CCL5)ELISA Kit	96 Test	38220090	24,500.00
CLS1103RA	Rat lipopolysaccharide binding protein,LBP ELISA Kit	96 Test	38220090	24,500.00
CLS1104RA	Rat Fatty acyl-CoA synthetase,ACS ELISA Kit	96 Test	38220090	24,500.00
CLS1105RA	Rat fatty acid binding protein,FABP4 ELISA Kit	96 Test	38220090	24,500.00
CLS1106RA	Rat neutrophil activating protein-2,NAP-2 ELISA Kit	96 Test	38220090	24,500.00
CLS1107RA	Rat Tumor necrosis factor soluble receptor I ,TNFsR- I ELISA KIT	96 Test	38220090	24,500.00
CLS1108RA	Rat Tumor necrosis factor soluble receptor II ,TNFsR- II ELISA KIT	96 Test	38220090	24,500.00
CLS1109RA	Rat tumor necrosis factor-related apoptosis-inducing ligand 1,TRAIL R1 ELISA Kit	96 Test	38220090	24,500.00
CLS1110RA	Rat tumor necrosis factor-related apoptosis-inducing ligand 3,TRAIL R3 ELISA Kit	96 Test	38220090	24,500.00
CLS1111RA	Rat tumor necrosis factor-related apoptosis-inducing ligand 4,TRAIL R4 ELISA Kit	96 Test	38220090	24,500.00
CLS1112RA	Rat Tumor Specific Growth Factor/tumor supplied group of factor,TSGF ELISA Kit	96 Test	38220090	24,500.00
CLS1113RA	Rat Netrin-1,Ntn1 ELISA Kit	96 Test	38220090	24,500.00
CLS1114RA	Rat major basic protein,MBP ELISA Kit	96 Test	38220090	24,500.00
CLS1115RA	Rat major histocompatibility complex I ,MHC I /AgB I /H-1 I ELISA Kit	96 Test	38220090	24,500.00
CLS1116RA	Rat major histocompatibility complex II ,MHC II /AgB II /H-1 II ELISA Kit	96 Test	38220090	24,500.00
CLS1117RA	Rat major histocompatibility complex III ,MHC III /AgB III /H-1 III ELISA Kit	96 Test	38220090	24,500.00

Cat.No.	Product Description	Pack Size	HSN	Unit Price
CLS1118RA	Rat transforming growth factor-beta-stimulated Protein clone-22,TSC22 ELISA Kit	96 Test	38220090	24,500.00
CLS1119RA	Rat Zinc finger CCCH domain-containing protein 15,ZC3H15 ELISA Kit	96 Test	38220090	24,500.00
CLS1120RA	Rat Total bile acide,TBA ELISA Kit	96 Test	38220090	24,500.00
CLS1121RA	Rat total thyroxine ,TT4 ELISA Kit	96 Test	38220090	24,500.00
CLS1122RA	Rat 3 · 5 · 3' - triiodothyronine,TT3 ELISA Kit	96 Test	38220090	24,500.00
CLS1123RA	Rat histon-H2b ELISA Kit	96 Test	38220090	24,500.00
CLS1124RA	Rat Cathepsin K,cath-K ELISA Kit	96 Test	38220090	24,500.00
CLS1125RA	Rat Tissue Polypeptide Antigen,TPA ELISA Kit	96 Test	38220090	24,500.00
CLS1126RA	Rat Tissue factor pathway inhibitor,TFPI ELISA Kit	96 Test	38220090	24,500.00
CLS1127RA	Rat DNA methyltransferase,DNAM ELISA Kit	96 Test	38220090	24,500.00
CLS1128RA	Rat DNA Binding Protein,DBP ELISA Kit	96 Test	38220090	24,500.00
CLS1129RA	Rat E-Cadherin,H-Cad/CDH13 ELISA Kit	96 Test	38220090	24,500.00
CLS1130RA	Rat dopamine-β-hydroxylase,DBH ELISA Kit	96 Test	38220090	24,500.00
CLS1131RA	Rat dopamine decarboxylase,DDC ELISA Kit	96 Test	38220090	24,500.00
CLS1132RA	Rat dopachrome tautomerase,DT ELISA Kit	96 Test	38220090	24,500.00
CLS1133RA	Rat Dynamin 1,DNM1 ELISA kit	96 Test	38220090	24,500.00
CLS1134RA	Rat dynamin 2,DNM2 ELISA Kit	96 Test	38220090	24,500.00
CLS1135RA	Rat dystrophin ELISA Kit	96 Test	38220090	24,500.00
CLS1136RA	Rat Protein Tyrosine Phosphatase Non Receptor Type 11 (PTPN11)ELISA Kit	96 Test	38220090	24,500.00
CLS1137RA	Rat Coronin 2A(CORO2A)ELISA Kit	96 Test	38220090	24,500.00
CLS1138RA	Rat Coronin 2B(CORO2B)ELISA Kit	96 Test	38220090	24,500.00
CLS1139RA	Rat Coronin 1B(CORO1B)ELISA Kit	96 Test	38220090	24,500.00
CLS1140RA	Rat Coronin 1C(CORO1C)ELISA Kit	96 Test	38220090	24,500.00
CLS1141RA	Rat Coronin 6(CORO6)ELISA Kit	96 Test	38220090	24,500.00
CLS1142RA	Rat Coronin 7(CORO7)ELISA Kit	96 Test	38220090	24,500.00
CLS1143RA	Rat Branched Chain Alpha-Ketoacid Dehydrogenase Kinase (BCKDK)ELISA Kit	96 Test	38220090	24,500.00
CLS1144RA	Rat Growth Arrest And DNA Damage Inducible Protein Alpha (GADD45a)ELISA Kit	96 Test	38220090	24,500.00
CLS1145RA	Rat Vaccinia Related Kinase 1 (VRK1)ELISA Kit	96 Test	38220090	24,500.00
CLS1146RA	Rat Bcl2/Adenovirus E1B 19kDa Interacting Protein 3 (BNIP3)ELISA Kit	96 Test	38220090	24,500.00
CLS1147RA	Rat Complement C1q tumor necrosis factor related protein 5,C1qtnf5/Ctrp5 ELISA Kit	96 Test	38220090	24,500.00
CLS1148RA	Rat Deiodinase Iodothyronine Type I (DIO1)ELISA Kit	96 Test	38220090	24,500.00
CLS1149RA	Rat Deiodinase Iodothyronine Type III (DIO3)ELISA Kit	96 Test	38220090	24,500.00
CLS1150RA	Rat Complement Factor H Related Protein 3 (CFHR3)ELISA Kit	96 Test	38220090	24,500.00
CLS1151RA	Rat Cleavage And Polyadenylation Specific Factor 1 (CPSF1)ELISA Kit	96 Test	38220090	24,500.00
CLS1152RA	Rat Delta Like Protein 4 (dLL4)ELISA Kit	96 Test	38220090	24,500.00
CLS1153RA	Rat Potassium Intermediate Small Conductance Calcium Activated Channel Subfamily N, Member 2 (KCNN2)ELISA Kit	96 Test	38220090	24,500.00
CLS1154RA	Rat Coiled Coil Domain Containing Protein 3 (CCDC3)ELISA Kit	96 Test	38220090	24,500.00
CLS1155RA	Rat Coiled Coil Domain Containing Protein 80 (CCDC80)ELISA Kit	96 Test	38220090	24,500.00
CLS1156RA	Rat Dynein Heavy Chain Domain Containing Protein 1 (DNHD1)ELISA Kit	96 Test	38220090	24,500.00
CLS1157RA	Rat Girdin (GRDN)ELISA Kit	96 Test	38220090	24,500.00
CLS1158RA	Rat Pseudouridylate Synthase 10 (PUS10)ELISA Kit	96 Test	38220090	24,500.00
CLS1159RA	Rat Protein Tyrosine Phosphatase Type IVA 3 (PTP4A3)ELISA Kit	96 Test	38220090	24,500.00
CLS1160RA	Rat Regenerating Islet Derived Protein 1 Alpha (REG1a)ELISA Kit	96 Test	38220090	24,500.00

Cat.No.	Product Description	Pack Size	HSN	Unit Price
CLS1161RA	Rat Protein Tyrosine Phosphatase Receptor Type K (PTPRK)ELISA Kit	96 Test	38220090	24,500.00
CLS1162RA	Rat Protein Tyrosine Phosphatase Receptor Type R (PTPRR)ELISA Kit	96 Test	38220090	24,500.00
CLS1163RA	Rat Protein Tyrosine Phosphatase Receptor Type N (PTPRN)ELISA Kit	96 Test	38220090	24,500.00
CLS1164RA	Rat Protein Tyrosine Phosphatase Receptor Type B (PTPRB)ELISA Kit	96 Test	38220090	24,500.00
CLS1165RA	Rat Protein Tyrosine Phosphatase Receptor Type O (PTPRO)ELISA Kit	96 Test	38220090	24,500.00
CLS1166RA	Rat Zinc Ribbon Domain Containing Protein 1 (ZNRD1)ELISA Kit	96 Test	38220090	24,500.00
CLS1167RA	Rat T-Cell, Immune Regulator 1 (TCIRG1)ELISA Kit	96 Test	38220090	24,500.00
CLS1168RA	Rat Histone deacetylase 10,HDAC10 ELISA KIT	96 Test	38220090	24,500.00
CLS1169RA	Rat Tomoregulin-1(TMEFF1)ELISA Kit	96 Test	38220090	24,500.00
CLS1170RA	Rat Tomoregulin-2(TMEFF2)ELISA Kit	96 Test	38220090	24,500.00
CLS1171RA	Rat Hemoglobin subunit alpha-1/2(HBA1)ELISA Kit	96 Test	38220090	24,500.00
CLS1172RA	Rat Hemoglobin subunit beta-1(HBB) ELISA Kit	96 Test	38220090	24,500.00
CLS1173RA	Rat Sclerostin domain-containing protein 1(SOSTDC1)ELISA Kit	96 Test	38220090	24,500.00
CLS1174RA	Rat Cathepsin B,cath-B ELISA Kit	96 Test	38220090	24,500.00
CLS1175RA	Rat Growth Differentiation Factor 8 (GDF8)ELISA kit	96 Test	38220090	24,500.00
CLS1176RA	Rat Copeptin ELISA Kit	96 Test	38220090	24,500.00
CLS1177RA	Rat Heat Shock Protein 90kDa Alpha A1 (HSP90aA1)ELISA kit	96 Test	38220090	24,500.00
CLS1178RA	Rat Heat Shock Protein 90kDa Beta 1 (HSP90b1)ELISA kit	96 Test	38220090	24,500.00
CLS1179RA	Rat bone sialoprotein,BSP ELISA Kit	96 Test	38220090	24,500.00
CLS1180RA	Rat Urotensin II(UII) ELISA Kit	96 Test	38220090	24,500.00
CLS1181RA	Rat Heparanase,HPA ELISA kit	96 Test	38220090	24,500.00
CLS1182RA	Rat Dipeptidyl peptidase 3(DPP3) ELISA Kit	96 Test	38220090	24,500.00
CLS1183RA	Rat Epithelial Cell Adhesion Molecule,Ep-CAM ELISA Kit	96 Test	38220090	24,500.00
CLS1184RA	Rat Glypican 2 (GPC2)ELISA Kit	96 Test	38220090	24,500.00
CLS1185RA	Rat Caldesmon,CALD1 ELISA Kit	96 Test	38220090	24,500.00
CLS1186RA	Rat Angiopoietin-like protein 4,ANGPTL4 ELISA Kit	96 Test	38220090	24,500.00
CLS1187RA	Rat Histone deacetylase 8,HDAC8 ELISA KIT	96 Test	38220090	24,500.00
CLS1188RA	Rat Follistatin-related protein 3(FSTL3)ELISA Kit	96 Test	38220090	24,500.00
CLS1189RA	Rat Platelet-derived growth factor subunit A,PDGFA ELISA kit	96 Test	38220090	24,500.00
CLS1190RA	Rat Islet amyloid polypeptide,IAPP ELISA Kit	96 Test	38220090	24,500.00
CLS1191RA	Rat Platelet-Derived Growth Factor-B,PDGF-B ELISA kit	96 Test	38220090	24,500.00
CLS1192RA	Rat Alpha-type platelet-derived growth factor receptor,PDGFRA ELISA kit	96 Test	38220090	24,500.00
CLS1193RA	Rat Platelet-derived growth factor C,PDGF-C ELISA kit	96 Test	38220090	24,500.00
CLS1194RA	Rat Reactive oxygen species modulator 1(ROMO1)ELISA Kit	96 Test	38220090	24,500.00
CLS1195RA	Rat Lymphotoxin-alpha,LTA ELISA Kit	96 Test	38220090	24,500.00
CLS1196RA	Rat Lymphotoxin-beta,LTB ELISA Kit	96 Test	38220090	24,500.00
CLS1197RA	Rat secretin receptor,SR ELISA Kit	96 Test	38220090	24,500.00
CLS1198RA	Rat Sperm-associated antigen 9(SPAG9) ELISA Kit	96 Test	38220090	24,500.00
CLS1199RA	Rat G-protein coupled receptor 54(KISS-1 receptor) ELISA Kit	96 Test	38220090	24,500.00
CLS1200RA	Rat Zinc finger E-box-binding homeobox 1 ,ZEB1 ELISA Kit	96 Test	38220090	24,500.00
CLS1201RA	Rat Androgen receptor,AR ELISA Kit	96 Test	38220090	24,500.00
CLS1202RA	Rat ELL-associated factor 2(EAF2) ELISA Kit	96 Test	38220090	24,500.00
CLS1203RA	Rat farnesyl-diphosphate farnesyltransferase 1,FDFT1 ELISA Kit	96 Test	38220090	24,500.00
CLS1204RA	Rat Glucose-6-phosphate 1-dehydrogenase(G6PD)ELISA kit	96 Test	38220090	24,500.00

Cat.No.	Product Description	Pack Size	HSN	Unit Price
CLS1205RA	Rat Steroid 17-alpha-hydroxylase/17,20 lyase,Cytochrome P450 17A1,CYP17A1 ELISA Kit	96 Test	38220090	24,500.00
CLS1206RA	Rat Zinc finger matrin-type protein 3(ZMAT3)ELISA Kit	96 Test	38220090	24,500.00
CLS1207RA	Rat Glucagon-like peptide 1 receptor (GLP1R) ELISA Kit	96 Test	38220090	24,500.00
CLS1208RA	Rat Insulin receptor substrate 1,IRS-1 ELISA Kit	96 Test	38220090	24,500.00
CLS1209RA	Rat Noggin,NOG ELISA Kit	96 Test	38220090	24,500.00
CLS1210RA	Rat Troponin T, slow skeletal muscle(TNNT1) ELISA Kit	96 Test	38220090	24,500.00
CLS1211RA	Rat Troponin T, slow skeletal muscle(TNNT3) ELISA Kit	96 Test	38220090	24,500.00
CLS1212RA	Rat Troponin I, fast skeletal muscle(TNNI2) ELISA Kit	96 Test	38220090	24,500.00
CLS1213RA	Rat Neurofilament heavy polypeptide,NEFH ELISA Kit	96 Test	38220090	24,500.00
CLS1214RA	Rat Histidine-proline-rich glycoprotein(HPRG) ELISA Kit	96 Test	38220090	24,500.00
CLS1215RA	Rat Receptor for advanced glycation end products, RAGE/AGER ELISA Kit	96 Test	38220090	24,500.00
CLS1216RA	Rat Thyroxine-Binding Globulin,TBG ELISA Kit	96 Test	38220090	24,500.00
CLS1217RA	Rat proteolipid protein,PLP ELISA Kit	96 Test	38220090	24,500.00
CLS1218RA	Rat parathyroid hormone-like protein,PLP ELISA Kit	96 Test	38220090	24,500.00
CLS1219RA	Rat Interleukin 4 receptor,IL4R/CD124 ELISA Kit	96 Test	38220090	24,500.00
CLS1220RA	Rat Sialidase-1,NEU1 ELISA Kit	96 Test	38220090	24,500.00
CLS1221RA	Rat Sialidase-2,NEU2 ELISA Kit	96 Test	38220090	24,500.00
CLS1222RA	Rat Sialidase-3,NEU3 ELISA Kit	96 Test	38220090	24,500.00
CLS1223RA	Rat high mobility group protein 17,HMG-17 ELISA Kit	96 Test	38220090	24,500.00
CLS1224RA	Rat Interleukin 17F,IL-17F ELISA Kit	96 Test	38220090	24,500.00
CLS1225RA	Rat Leukotriene B4 receptor 1,LTB4R ELISA Kit	96 Test	38220090	24,500.00
CLS1226RA	Rat Leukotriene B4 receptor 2,LTB4R2 ELISA Kit	96 Test	38220090	24,500.00
CLS1227RA	Rat latent transforming growth factor beta binding protein 2,LTBP2 ELISA Kit	96 Test	38220090	24,500.00
CLS1228RA	Rat latent transforming growth factor beta binding protein 1,LTBP1 ELISA Kit	96 Test	38220090	24,500.00
CLS1229RA	Rat Prostaglandin reductase 1,PTGR1 ELISA Kit	96 Test	38220090	24,500.00
CLS1230RA	Rat Clathrin light chain B,CLTB ELISA Kit	96 Test	38220090	24,500.00
CLS1231RA	Rat ficolin 2,FCN2 ELISA Kit	96 Test	38220090	24,500.00
CLS1232RA	Rat ficolin 1,FCN1 ELISA Kit	96 Test	38220090	24,500.00
CLS1233RA	Rat secreted protein acidic and rich in cysteine,SPARC ELISA Kit	96 Test	38220090	24,500.00
CLS1234RA	Rat Beta-defensin 1,DEFB1 ELISA kit	96 Test	38220090	24,500.00
CLS1235RA	Rat Beta-defensin 4,DEFB4 ELISA kit	96 Test	38220090	24,500.00
CLS1236RA	Rat Beta-defensin 3,DEFB3 ELISA kit	96 Test	38220090	24,500.00
CLS1237RA	Rat Defensin Beta 14 (DEFb14)ELISA Kit	96 Test	38220090	24,500.00
CLS1238RA	Rat Undercarboxylated Osteocalcin (ucOC) ELISA Kit	96 Test	38220090	24,500.00
CLS1239RA	Rat Kremen protein 1(KREMEN1) ELISA Kit	96 Test	38220090	24,500.00
CLS1240RA	Rat Endothelin-1 receptor,EDNRA ELISA Kit	96 Test	38220090	24,500.00
CLS1241RA	Rat Hyaluronan mediated motility receptor(HMMR) ELISA Kit	96 Test	38220090	24,500.00
CLS1242RA	Rat Protease Activated Receptor 1(PAR1) ELISA Kit	96 Test	38220090	24,500.00
CLS1243RA	Rat Protease Activated Receptor 2(PAR2) ELISA Kit	96 Test	38220090	24,500.00
CLS1244RA	Rat Protease Activated Receptor 3(PAR3) ELISA Kit	96 Test	38220090	24,500.00
CLS1245RA	Rat Protease Activated Receptor 4(PAR4) ELISA Kit	96 Test	38220090	24,500.00
CLS1246RA	Rat Thymidine kinase, cytosolic(TK1) ELISA Kit	96 Test	38220090	24,500.00
CLS1247RA	Rat Acetyl Coenzyme A,A-COA ELISA Kit	96 Test	38220090	24,500.00
CLS1248RA	Rat Atrial natriuretic peptide receptor 2,NPR2 ELISA kit	96 Test	38220090	24,500.00
CLS1249RA	Rat Atrial natriuretic peptide receptor 1,NPR1 ELISA kit	96 Test	38220090	24,500.00
CLS1250RA	Rat Atrial natriuretic peptide receptor 3,NPR3 ELISA kit	96 Test	38220090	24,500.00
CLS1251RA	Rat Atrial natriuretic peptide-converting enzyme,CORIN ELISA Kit	96 Test	38220090	24,500.00
CLS1252RA	Rat Cytokine receptor-like factor 2,CRLF2 ELISA kit	96 Test	38220090	24,500.00
CLS1253RA	Rat SPRY domain-containing SOCS box protein 2,SPSB2 ELISA kit	96 Test	38220090	24,500.00
CLS1254RA	Rat Serum response factor-binding protein 1,SRFBP1 ELISA kit	96 Test	38220090	24,500.00

Cat.No.	Product Description	Pack Size	HSN	Unit Price
CLS1255RA	Rat Fibroblast growth factor-binding protein 1,FGFBP1 ELISA kit	96 Test	38220090	24,500.00
CLS1256RA	Rat Polyamine-modulated factor 1-binding protein 1,PMFBP1 ELISA kit	96 Test	38220090	24,500.00
CLS1257RA	Rat Formin-binding protein 1,FNBP1 ELISA kit	96 Test	38220090	24,500.00
CLS1258RA	Rat Formin-binding protein 1-like,FNBP1L ELISA kit	96 Test	38220090	24,500.00
CLS1259RA	Rat 6-phosphofructo-2-kinase/fructose-2,6-biphosphatase 1,PFKFB1 ELISA kit	96 Test	38220090	24,500.00
CLS1260RA	Rat 6-phosphofructo-2-kinase/fructose-2,6-biphosphatase 2,PFKFB2 ELISA kit	96 Test	38220090	24,500.00
CLS1261RA	Rat Collagen alpha-1(XVIII) chain,COL18A1 ELISA kit	96 Test	38220090	24,500.00
CLS1262RA	Rat Glycogen synthase kinase-3 alpha,Gsk3a ELISA Kit	96 Test	38220090	24,500.00
CLS1263RA	Rat Glycogen synthase 2,GYS2 ELISA Kit	96 Test	38220090	24,500.00
CLS1264RA	Rat 6-phosphofructokinase, liver type(PFKL)ELISA kit	96 Test	38220090	24,500.00
CLS1265RA	Rat 6-phosphofructokinase type C,PFKC ELISA Kit	96 Test	38220090	24,500.00
CLS1266RA	Rat polymeric immunoglobulin receptor/secretory component,PIGR/SC ELISA Kit	96 Test	38220090	24,500.00
CLS1267RA	Rat Transcription factor 4,TCF-4 ELISA Kit	96 Test	38220090	24,500.00
CLS1268RA	Rat Heat Shock 70kDa Protein 5 (HSPA5)ELISA kit	96 Test	38220090	24,500.00
CLS1269RA	Rat T-lymphocyte activation antigen CD86,CD86 ELISA Kit	96 Test	38220090	24,500.00
CLS1270RA	Rat Protein tyrosine phosphatase receptor type A,PTPRA ELISA Kit	96 Test	38220090	24,500.00
CLS1271RA	Rat leukocyte common antigen,LCA/CD45 ELISA Kit	96 Test	38220090	24,500.00
CLS1272RA	Rat Protein Tyrosine Phosphatase Receptor Type S (PTPRS)ELISA Kit	96 Test	38220090	24,500.00
CLS1273RA	Rat Protein Tyrosine Phosphatase Receptor Type T,PTPRT/LAR ELISA Kit	96 Test	38220090	24,500.00
CLS1274RA	Rat Protein Tyrosine Phosphatase Receptor Type J (PTPRJ)ELISA Kit	96 Test	38220090	24,500.00
CLS1275RA	Rat Glutamate [NMDA] receptor subunit zeta-1,GRIN1 ELISA Kit	96 Test	38220090	24,500.00
CLS1276RA	Rat Endothelin 3,ET-3 ELISA Kit	96 Test	38220090	24,500.00
CLS1277RA	Rat Endothelin-converting enzyme 1,ECE1 ELISA Kit	96 Test	38220090	24,500.00
CLS1278RA	Rat soluble amyloid precursor protein β ,sAPP β ELISA Kit	96 Test	38220090	24,500.00
CLS1279RA	Rat Breast cancer susceptibility protein 1,BRCA-1 ELISA Kit	96 Test	38220090	24,500.00
CLS1280RA	Rat Breast cancer susceptibility protein 2,BRCA-2 ELISA Kit	96 Test	38220090	24,500.00
CLS1281RA	Rat Lys-63-specific deubiquitinase BRCC36,BRCC3/BRCC36 ELISA Kit	96 Test	38220090	24,500.00
CLS1282RA	Rat Myo-inositol oxygenase,MIOX ELISA Kit	96 Test	38220090	24,500.00
CLS1283RA	Rat Kallikrein 8,KLK8 ELISA Kit	96 Test	38220090	24,500.00
CLS1284RA	Rat Kallikrein 7,KLK7 ELISA Kit	96 Test	38220090	24,500.00
CLS1285RA	Rat Protein jagged-1,JAG1/CD339 ELISA Kit	96 Test	38220090	24,500.00
CLS1286RA	Rat Protein jagged-2,JAG2 ELISA Kit	96 Test	38220090	24,500.00
CLS1287RA	Rat Neurogenic locus notch homolog protein 1,NOTCH1 ELISA Kit	96 Test	38220090	24,500.00
CLS1288RA	Rat Collagen alpha-1(IV) chain,COL4A1/Collagen IV ELISA Kit	96 Test	38220090	24,500.00
CLS1289RA	Rat Urocortin-2,UCN2/SRP LISA Kit	96 Test	38220090	24,500.00
CLS1290RA	Rat Urocortin-3,UCN3/SPC ELISA Kit	96 Test	38220090	24,500.00
CLS1291RA	Rat Apelin receptor,APLNR ELISA Kit	96 Test	38220090	24,500.00
CLS1292RA	Rat Potassium channel subfamily K member 1,KCNK1 ELISA Kit	96 Test	38220090	24,500.00
CLS1293RA	Rat Potassium channel subfamily K member 3,KCNK3 ELISA Kit	96 Test	38220090	24,500.00
CLS1294RA	Rat Potassium channel subfamily K member 9,KCNK9 ELISA Kit	96 Test	38220090	24,500.00

Cat.No.	Product Description	Pack Size	HSN	Unit Price
CLS1295RA	Rat Potassium channel subfamily K member 10,KCNK10 ELISA Kit	96 Test	38220090	24,500.00
CLS1296RA	Rat Potassium channel subfamily K member 12,KCNK12 ELISA Kit	96 Test	38220090	24,500.00
CLS1297RA	Rat Potassium channel subfamily K member 13,KCNK13 ELISA Kit	96 Test	38220090	24,500.00
CLS1298RA	Rat Potassium channel subfamily K member 15,KCNK15 ELISA Kit	96 Test	38220090	24,500.00
CLS1299RA	Rat Potassium channel subfamily K member 18,KCNK18 ELISA Kit	96 Test	38220090	24,500.00
CLS1300RA	Rat ATP-sensitive inward rectifier potassium channel 1,KCNJ1/ROM-K ELISA Kit	96 Test	38220090	24,500.00
CLS1301RA	Rat ATP-sensitive inward rectifier potassium channel 10,KCNJ10/Kir4.1 ELISA Kit	96 Test	38220090	24,500.00
CLS1302RA	Rat ATP-sensitive inward rectifier potassium channel 11,KCNJ11/Kir6.2 ELISA Kit	96 Test	38220090	24,500.00
CLS1303RA	Rat ATP-sensitive inward rectifier potassium channel 12,KCNJ12/Kir2.2 ELISA Kit	96 Test	38220090	24,500.00
CLS1304RA	Rat Inward rectifier potassium channel 13,KCNJ13 ELISA Kit	96 Test	38220090	24,500.00
CLS1305RA	Rat ATP-sensitive inward rectifier potassium channel 14,KCNJ14/Kir2.4 ELISA Kit	96 Test	38220090	24,500.00
CLS1306RA	Rat ATP-sensitive inward rectifier potassium channel 15,KCNJ15/Kir4.2 ELISA Kit	96 Test	38220090	24,500.00
CLS1307RA	Rat Inward rectifier potassium channel 16,KCNJ16 ELISA Kit	96 Test	38220090	24,500.00
CLS1308RA	Rat Inward rectifier potassium channel 2,KCNJ2 ELISA Kit	96 Test	38220090	24,500.00
CLS1309RA	Rat G protein-activated inward rectifier potassium channel 1,KCNJ3/GIRK1 ELISA Kit	96 Test	38220090	24,500.00
CLS1310RA	Rat Inward rectifier potassium channel 4,KCNJ4 ELISA Kit	96 Test	38220090	24,500.00
CLS1311RA	Rat G protein-activated inward rectifier potassium channel 4,KCNJ5/GIRK4 ELISA Kit	96 Test	38220090	24,500.00
CLS1312RA	Rat G protein-activated inward rectifier potassium channel 2,KCNJ6/GIRK2 ELISA Kit	96 Test	38220090	24,500.00
CLS1313RA	Rat ATP-sensitive inward rectifier potassium channel 8,KCNJ8/Kir6.1 ELISA Kit	96 Test	38220090	24,500.00
CLS1314RA	Rat G protein-activated inward rectifier potassium channel 3,KCNJ9/GIRK3 ELISA Kit	96 Test	38220090	24,500.00
CLS1315RA	Rat Bruton tyrosine kinase,Btk ELISA Kit	96 Test	38220090	24,500.00
CLS1316RA	Rat Deoxyribonuclease 1,DNase-1 ELISA Kit	96 Test	38220090	24,500.00
CLS1317RA	Rat Deoxyribonuclease-2-alpha, DNASE2A ELISA Kit	96 Test	38220090	24,500.00
CLS1318RA	Rat Deoxyribonuclease-2-beta, DNASE2B ELISA Kit	96 Test	38220090	24,500.00
CLS1319RA	Rat Deoxyribonuclease-1-like 1, DNASE1L1 ELISA Kit	96 Test	38220090	24,500.00
CLS1320RA	Rat Opsin 5 (OPN5)ELISA Kit	96 Test	38220090	24,500.00
CLS1321RA	Rat Isocitrate dehydrogenase [NADP] cytoplasmic(IDH1) ELISA Kit	96 Test	38220090	24,500.00
CLS1322RA	Rat Isocitrate dehydrogenase [NADP] mitochondrial(IDH2) ELISA Kit	96 Test	38220090	24,500.00
CLS1323RA	Rat Perilipin-1(PLIN1)ELISA kit	96 Test	38220090	24,500.00
CLS1324RA	Rat Oxidized low-density lipoprotein receptor 1,OLR1/LOX1 ELISA kit	96 Test	38220090	24,500.00
CLS1325RA	Rat matrix metalloproteinase 12,MMP-12 ELISA kit	96 Test	38220090	24,500.00
CLS1326RA	Rat Rho Guanine Nucleotide Exchange Factor 1(ARHGEF1)ELISA Kit	96 Test	38220090	24,500.00
CLS1327RA	Rat Rho Guanine Nucleotide Exchange Factor 2(ARHGEF2)ELISA Kit	96 Test	38220090	24,500.00
CLS1328RA	Rat Rho Guanine Nucleotide Exchange Factor 4(ARHGEF4)ELISA Kit	96 Test	38220090	24,500.00
CLS1329RA	Rat Rho Guanine Nucleotide Exchange Factor 6(ARHGEF6)ELISA Kit	96 Test	38220090	24,500.00
CLS1330RA	Rat Rho Guanine Nucleotide Exchange Factor 7(ARHGEF7)ELISA Kit	96 Test	38220090	24,500.00

Cat.No.	Product Description	Pack Size	HSN	Unit Price
CLS1331RA	Rat anti-zona pellucida antibody,aZP ELISA Kit	96 Test	38220090	24,500.00
CLS1332RA	Rat Hemopexin,HPX ELISA kit	96 Test	38220090	24,500.00
CLS1333RA	Rat Selenium-binding protein 1,SELENBP1 ELISA kit	96 Test	38220090	24,500.00
CLS1334RA	Rat mitogen activated protein kinase3,MAPK3/PRKM3 ELISA Kit	96 Test	38220090	24,500.00
CLS1335RA	Rat Calpastatin/Calpain inhibitor,CAST ELISA Kit	96 Test	38220090	24,500.00
CLS1336RA	Rat glucokinase regulatory protein,GKRP ELISA Kit	96 Test	38220090	24,500.00
CLS1337RA	Rat Regenerating islet-derived protein 3-alpha,REG-3-alpha ELISA Kit	96 Test	38220090	24,500.00
CLS1338RA	Rat Copper transporter 1,COPT1/SLC31A1 ELISA Kit	96 Test	38220090	24,500.00
CLS1339RA	Rat Growth arrest-specific protein 6,GAS6 ELISA Kit	96 Test	38220090	24,500.00
CLS1340RA	Rat Retinal dehydrogenase 1,ALDH1A1 ELISA Kit	96 Test	38220090	24,500.00
CLS1341RA	Rat Delta Like Protein 1(DLL1)ELISA Kit	96 Test	38220090	24,500.00
CLS1342RA	Rat Delta Like Protein 3(DLL3)ELISA Kit	96 Test	38220090	24,500.00
CLS1343RA	Rat Neurogenic locus notch homolog protein 2,NOTCH2 ELISA Kit	96 Test	38220090	24,500.00
CLS1344RA	Rat Neurogenic locus notch homolog protein 3,NOTCH3 ELISA Kit	96 Test	38220090	24,500.00
CLS1345RA	Rat Neurogenic locus notch homolog protein 4,NOTCH4 ELISA Kit	96 Test	38220090	24,500.00
CLS1346RA	Rat Ghrelin receptor,GR/GHSR ELISA Kit	96 Test	38220090	24,500.00
CLS1347RA	Rat Synuclein-gamma,SNCG ELISA Kit	96 Test	38220090	24,500.00
CLS1348RA	Rat Acetyl Coenzyme A carboxylase alpha,ACACA ELISA Kit	96 Test	38220090	24,500.00
CLS1349RA	Rat Alpha-1-macroglobulin,Alpha-1-M ELISA Kit	96 Test	38220090	24,500.00
CLS1350RA	Rat Fibrinogen-like protein 1,FGL1 ELISA Kit	96 Test	38220090	24,500.00
CLS1351RA	Rat Interleukin 6 receptor,IL6R ELISA Kit	96 Test	38220090	24,500.00
CLS1352RA	Rat Transglutaminase-3,TGM3 ELISA Kit	96 Test	38220090	24,500.00
CLS1353RA	Rat Alpha-1B-glycoprotein,A1BG ELISA Kit	96 Test	38220090	24,500.00
CLS1354RA	Rat Fetuin B,FETU-B ELISA Kit	96 Test	38220090	24,500.00
CLS1355RA	Rat Annexin A3 (ANXA3)ELISA Kit	96 Test	38220090	24,500.00
CLS1356RA	Rat Annexin A6 (ANXA6)ELISA Kit	96 Test	38220090	24,500.00
CLS1357RA	Rat Annexin A4 (ANXA4)ELISA Kit	96 Test	38220090	24,500.00
CLS1358RA	Rat Telomerase reverse transcriptase,TERT ELISA Kit	96 Test	38220090	24,500.00
CLS1359RA	Rat Homeobox protein Nkx-2.1,NKX2-1 ELISA Kit	96 Test	38220090	24,500.00
CLS1360RA	Rat Secreted Frizzled Related Protein 1 (SFRP1)ELISA Kit	96 Test	38220090	24,500.00
CLS1361RA	Rat Placenta-specific protein 1,PLAC1 ELISA Kit	96 Test	38220090	24,500.00
CLS1362RA	Rat TGF-beta receptor type-1,TGFB1 ELISA Kit	96 Test	38220090	24,500.00
CLS1363RA	Rat Interleukin 28A,IL-28A/IFN-λ2 ELISA Kit	96 Test	38220090	24,500.00
CLS1364RA	Rat 1,25-dihydroxyvitamin D(3) 24-hydroxylase,CYP24A1 ELISA Kit	96 Test	38220090	24,500.00
CLS1365RA	Rat Nestin(NES) ELISA Kit	96 Test	38220090	24,500.00
CLS1366RA	Rat Tumor necrosis factor receptor superfamily member 4,Tnfrsf4/Ox40 ELISA Kit	96 Test	38220090	24,500.00
CLS1367RA	Rat Neuromedin U (NMU)ELISA kit	96 Test	38220090	24,500.00
CLS1368RA	Rat 8-iso prostaglandin F2α,8-iso-PGF2a ELISA Kit	96 Test	38220090	24,500.00
CLS1369RA	Rat chemokine (C-C motif) ligand 5,CCL5 ELISA KIT	96 Test	38220090	24,500.00
CLS1370RA	Rat CXC-chemokine ligand 10,CXCL10 ELISA KIT	96 Test	38220090	24,500.00
CLS1371RA	Rat Neural-Cadherin(N-Cad)ELISA Kit	96 Test	38220090	24,500.00
CLS1372RA	Rat Peptide YY(PYY)ELISA Kit	96 Test	38220090	24,500.00
CLS1373RA	Rat 8-isoprostane ELISA Kit	96 Test	38220090	24,500.00
CLS0001PO	Porcine Interferon γ ,IFN-γ ELISA Kit	96 Test	38220090	24,500.00
CLS0002PO	Porcine Granulocyte-Macrophage Colony Stimulating Factor,GM-CSF ELISA KIT	96 Test	38220090	24,500.00
CLS0003PO	Porcine Immunoglobulin G,IgG ELISA Kit	96 Test	38220090	24,500.00
CLS0004PO	Porcine Immunoglobulin A,IgA ELISA KIT	96 Test	38220090	24,500.00
CLS0005PO	Porcine Receptor for advanced glycation end products, RAGE/AGER ELISA Kit	96 Test	38220090	24,500.00
CLS0006PO	Porcine procollagen I N-terminal peptide,P I NP ELISA Kit	96 Test	38220090	24,500.00

Cat.No.	Product Description	Pack Size	HSN	Unit Price
CLS0007PO	Porcine Procollagen Type I Intact N-terminal Propeptide(P1NP)ELISA Kit	96 Test	38220090	24,500.00
CLS0008PO	Porcine Noradrenaline,NE ELISA Kit	96 Test	38220090	24,500.00
CLS0009PO	Porcine Melatonin,MT ELISA Kit	96 Test	38220090	24,500.00
CLS0010PO	Porcine Catechol-O-Methyltransferase(COMT)ELISA Kit	96 Test	38220090	24,500.00
CLS0011PO	Porcine monoamine oxidase B(MAOB)ELISA Kit	96 Test	38220090	24,500.00
CLS0012PO	Porcine monoamine oxidase A(MAOA)ELISA Kit	96 Test	38220090	24,500.00
CLS0013PO	Porcine tyrosine hydroxylase(TH)ELISA Kit	96 Test	38220090	24,500.00
CLS0014PO	Porcine corticotropin-releasing factor,CRF ELISA Kit	96 Test	38220090	24,500.00
CLS0015PO	Porcine Interleukin 6,IL-6 ELISA Kit	96 Test	38220090	24,500.00
CLS0016PO	Porcine tumor necrosis factor α ,TNF- α ELISA Kit	96 Test	38220090	24,500.00
CLS0017PO	Porcine Cortisol(COR) ELISA Kit	96 Test	38220090	24,500.00
CLS0018PO	Porcine Immunoglobulin M,IgM ELISA Kit	96 Test	38220090	24,500.00
CLS0019PO	Porcine interleukin 4,IL-4 ELISA Kit	96 Test	38220090	24,500.00
CLS0020PO	Porcine Pancreatic Polypeptide,PP ELISA Kit	96 Test	38220090	24,500.00
CLS0021PO	Porcine Tryptophan Hydroxylase 1(TPH1)ELISA Kit	96 Test	38220090	24,500.00
CLS0022PO	Porcine adrenocorticotrophic hormone,ACTH ELISA Kit	96 Test	38220090	24,500.00
CLS0023PO	Porcine interleukin 3,IL-3 ELISA Kit	96 Test	38220090	24,500.00
CLS0024PO	Porcine α 2-Antiplasmin, α 2-AP ELISA Kit	96 Test	38220090	24,500.00
CLS0025PO	Porcine angiotensin II,ANG-II ELISA Kit	96 Test	38220090	24,500.00
CLS0026PO	Porcine Interleukin 13,IL-13 ELISA KIT	96 Test	38220090	24,500.00
CLS0027PO	Porcine thrombin-antithrombin complex(TAT)ELISA Kit	96 Test	38220090	24,500.00
CLS0028PO	Porcine Immunoglobulin E,IgE ELISA Kit	96 Test	38220090	24,500.00
CLS0029PO	Porcine Type II Procollagen,PC II ELISA Kit	96 Test	38220090	24,500.00
CLS0030PO	Porcine adrenocorticotrophic hormone,ACTH ELISA Kit	96 Test	38220090	24,500.00
CLS0031PO	Porcine Cytosolic Phospholipase A2,cPLA2 ELISA Kit	96 Test	38220090	24,500.00
CLS0032PO	Porcine growth hormone,GH ELISA Kit	96 Test	38220090	24,500.00
CLS0033PO	Porcine Cystatin C,Cys-C ELISA Kit	96 Test	38220090	24,500.00
CLS0034PO	Porcine prolactin,PRL ELISA Kit	96 Test	38220090	24,500.00
CLS0035PO	Porcine Epinephrine/Adrenaline,EPI ELISA Kit	96 Test	38220090	24,500.00
CLS0036PO	Porcine heparin(Hep)ELISA Kit	96 Test	38220090	24,500.00
CLS0037PO	Porcine Monocyte Chemotactic Protein 1,MCP-1 ELISA KIT	96 Test	38220090	24,500.00
CLS0038PO	Porcine interleukin 10,IL-10 ELISA Kit	96 Test	38220090	24,500.00
CLS0039PO	Porcine interleukin 8,IL-8 ELISA Kit	96 Test	38220090	24,500.00
CLS0040PO	Porcine Interleukin 12,IL-12/P40 ELISA KIT	96 Test	38220090	24,500.00
CLS0041PO	Porcine Interleukin 1 β ,IL-1 β ELISA Kit	96 Test	38220090	24,500.00
CLS0042PO	Porcine Leukotriene B4,LTB4 ELISA KIT	96 Test	38220090	24,500.00
CLS0043PO	Porcine prostaglandin G/H synthase 2(PTGS2)ELISA Kit	96 Test	38220090	24,500.00
CLS0044PO	Porcine Prostaglandin E2,PG-E2 ELISA Kit	96 Test	38220090	24,500.00
CLS0045PO	Porcine Interferon β ,IFN- β /IFNB ELISA Kit	96 Test	38220090	24,500.00
CLS0046PO	Porcine C-telopeptide of type II collagen,CTX-II ELISA Kit	96 Test	38220090	24,500.00
CLS0047PO	Porcine cluster Of differentiation,CD4 ELISA Kit	96 Test	38220090	24,500.00
CLS0048PO	Porcine cluster of differentiation 8,CD8 ELISA Kit	96 Test	38220090	24,500.00
CLS0049PO	Porcine Leptin,LEP ELISA Kit	96 Test	38220090	24,500.00
CLS0050PO	Porcine Matrix Metalloproteinase 2(MMP-2)ELISA Kit	96 Test	38220090	24,500.00
CLS0051PO	Porcine intestinal fatty acid binding protein,iFABP ELISA Kit	96 Test	38220090	24,500.00
CLS0052PO	Porcine Keratinocyte Growth Factor,KGF ELISA Kit	96 Test	38220090	24,500.00
CLS0053PO	Porcine interleukin 17,IL-17 ELISA Kit	96 Test	38220090	24,500.00
CLS0054PO	Porcine Interleukin 21,IL-21 ELISA Kit	96 Test	38220090	24,500.00
CLS0055PO	Porcine Insulin-like growth factor binding protein (IGFBP- I) ELISA Kit	96 Test	38220090	24,500.00
CLS0056PO	Porcine Insulin-like growth factors binding protein 2 · IGFBP-2 Elisa Kit	96 Test	38220090	24,500.00
CLS0057PO	Porcine insulin-like growth factors-1,IGF-1 ELISA Kit	96 Test	38220090	24,500.00
CLS0058PO	Porcine insulin-like growth factors 2,IGF-2 ELISA Kit	96 Test	38220090	24,500.00

Cat.No.	Product Description	Pack Size	HSN	Unit Price
CLS0059PO	Porcine growth hormone releasing peptide-Ghrelin,GHRP-Ghrelin ELISA Kit	96 Test	38220090	24,500.00
CLS0060PO	Porcine high sensitivity C-Reactive Protein,hs-CRP ELISA Kit	96 Test	38220090	24,500.00
CLS0061PO	Porcine Erythropoietin,EPO ELISA Kit	96 Test	38220090	24,500.00
CLS0062PO	Porcine ferritin,FE ELISA Kit	96 Test	38220090	24,500.00
CLS0063PO	Porcine Collagen Type I (Col I)ELISA Kit	96 Test	38220090	24,500.00
CLS0064PO	Porcine cytosolic phospholipase A2,cPLA2 ELISA Kit	96 Test	38220090	24,500.00
CLS0065PO	Porcine Carboxyterminal propeptide of type II procollagen,P II CP ELISA Kit	96 Test	38220090	24,500.00
CLS0066PO	Porcine Cathepsin B,cath-B ELISA Kit	96 Test	38220090	24,500.00
CLS0067PO	Porcine cluster Of differentiation,CD14 ELISA Kit	96 Test	38220090	24,500.00
CLS0068PO	Porcine Collagen Type II,Col II ELISA Kit	96 Test	38220090	24,500.00
CLS0069PO	Porcine α1-Acid glycoprotein,α1-AGP ELISA Kit	96 Test	38220090	24,500.00
CLS0070PO	Porcine α-Smooth muscle actin,α-SMA ELISA Kit	96 Test	38220090	24,500.00
CLS0071PO	Porcine parvovirus(PPV)ELISA Kit	96 Test	38220090	24,500.00
CLS0072PO	Porcine soluble E-selectin,sE-selectin ELISA Kit	96 Test	38220090	24,500.00
CLS0073PO	Porcine soluble P-selectin,sP-Selectin ELISA Kit	96 Test	38220090	24,500.00
CLS0074PO	Porcine major histocompatibility complex II,MHC II/HLA-II ELISA Kit	96 Test	38220090	24,500.00
CLS0075PO	Porcine Beta-Endorphin,β-EP ELISA Kit	96 Test	38220090	24,500.00
CLS0076PO	Porcine classical swine fever virus Antibody(CSFV Ab)ELISA Kit	96 Test	38220090	24,500.00
CLS0077PO	Porcine C-telopeptide of type I collagen(CTX- I)ELISA Kit	96 Test	38220090	24,500.00
CLS0078PO	Porcine diamine oxidase,DAO ELISA Kit	96 Test	38220090	24,500.00
CLS0079PO	Porcine Heat Shock Protein 90(HSP90)ELISA Kit	96 Test	38220090	24,500.00
CLS0080PO	Porcine insulin-like growth factors binding protein 3,IGFBP-3 ELISA Kit	96 Test	38220090	24,500.00
CLS0081PO	Porcine Interleukin 1,IL-1 ELISA Kit	96 Test	38220090	24,500.00
CLS0082PO	Porcine Methemoglobin,MHB ELISA Kit	96 Test	38220090	24,500.00
CLS0083PO	Porcine N-terminal pro-brain natriuretic peptide,NT-proBNP ELISA KIT	96 Test	38220090	24,500.00
CLS0084PO	Porcine oxidized lowdensity lipoprotein,OxLDL ELISA Kit	96 Test	38220090	24,500.00
CLS0085PO	Porcine thrombomodulin,TM ELISA Kit	96 Test	38220090	24,500.00
CLS0086PO	Porcine β-Amylase,AMS/AMY ELISA Kit	96 Test	38220090	24,500.00
CLS0087PO	Porcine C-reactive protein,CRP ELISA Kit	96 Test	38220090	24,500.00
CLS0088PO	Porcine D-Dimer,D2D ELISA Kit	96 Test	38220090	24,500.00
CLS0089PO	Porcine interleukin 2,IL-2 ELISA Kit	96 Test	38220090	24,500.00
CLS0090PO	Porcine myeloperoxidase,MPO ELISA Kit	96 Test	38220090	24,500.00
CLS0091PO	Porcine matrix metalloproteinase 9,MMP-9 ELISA Kit	96 Test	38220090	24,500.00
CLS0092PO	Porcine Nerve growth factor,NGF ELISA kit	96 Test	38220090	24,500.00
CLS0093PO	Porcine Orexin receptor,OXR ELISA Kit	96 Test	38220090	24,500.00
CLS0094PO	Porcine parvovirus(PPV)ELISA Kit	96 Test	38220090	24,500.00
CLS0095PO	Porcine secretory immunoglobulin A,SIgA ELISA Kit	96 Test	38220090	24,500.00
CLS0096PO	Porcine soluble vascular endothelial growth factor receptor-2,VEGFR-2/sFLK-1 ELISA Kit	96 Test	38220090	24,500.00
CLS0097PO	Porcine Somatostatin,SS ELISA Kit	96 Test	38220090	24,500.00
CLS0098PO	Porcine Super Oxidase Dimutase,SOD ELISA Kit	96 Test	38220090	24,500.00
CLS0099PO	Porcine total cholesterol,TC ELISA Kit	96 Test	38220090	24,500.00
CLS0100PO	Porcine transforming growth factor β1,TGF-β1 ELISA Kit	96 Test	38220090	24,500.00
CLS0101PO	Porcine Ultra Sensitive growth hormone,U S-GH ELISA Kit	96 Test	38220090	24,500.00
CLS0102PO	Porcine Vascular Endothelial-Cadherin Complex,VE-cad ELISA Kit	96 Test	38220090	24,500.00
CLS0103PO	Porcine α-glutathione S-transferases,α-GST ELISA Kit	96 Test	38220090	24,500.00
CLS0104PO	Porcine Cathepsin B,cath-B ELISA Kit	96 Test	38220090	24,500.00
CLS0105PO	Porcine gamma glutamyl transpeptidase,GGT ELISA Kit	96 Test	38220090	24,500.00
CLS0106PO	Porcine Epidermal growth factor,EGF ELISA Kit	96 Test	38220090	24,500.00
CLS0107PO	Porcine Interferon α(IFN-α)ELISA Kit	96 Test	38220090	24,500.00

Cat.No.	Product Description	Pack Size	HSN	Unit Price
CLS0108PO	Porcine cross linked N-telopeptide of type I collagen(NTX)ELISA Kit	96 Test	38220090	24,500.00
CLS0109PO	Porcine Cross-linked Carboxy-terminal telopeptide of type I collagen(I ctp)ELISA Kit	96 Test	38220090	24,500.00
CLS0110PO	Porcine type I procollagen(PC I) ELISA Kit	96 Test	38220090	24,500.00
CLS0111PO	Porcine cross-linked C-telopeptides of Type I collagen,C I CP ELISA Kit	96 Test	38220090	24,500.00
CLS0112PO	Porcine Carboxyterminal propeptide of type I procollagen,P I CP ELISA Kit	96 Test	38220090	24,500.00
CLS0113PO	Porcine Krebs von den Lundgen-6 (KL-6) ELISA Kit	96 Test	38220090	24,500.00
CLS0114PO	Porcine type II collagen helical peptide,HELIX-II ELISA Kit	96 Test	38220090	24,500.00
CLS0115PO	Porcine Collagen Type III,Col III ELISA KIT	96 Test	38220090	24,500.00
CLS0116PO	Porcine N-terminal procollagen III propeptide,P III NP ELISA Kit	96 Test	38220090	24,500.00
CLS0117PO	Porcine procollagen III N-terminal peptide,P III NT ELISA Kit	96 Test	38220090	24,500.00
CLS0118PO	Porcine Carboxyterminal propeptide of type III procollagen,P III CP ELISA Kit	96 Test	38220090	24,500.00
CLS0119PO	Porcine 4-Hydroxynonenal,4HNE ELISA Kit	96 Test	38220090	24,500.00
CLS0120PO	Porcine Collagen Type IV,Col IV ELISA KIT	96 Test	38220090	24,500.00
CLS0121PO	Porcine 5-lipoxygenase,5-LO/LOX ELISA Kit	96 Test	38220090	24,500.00
CLS0122PO	Porcine 6-hydroxydopamine,6-OHDA ELISA Kit	96 Test	38220090	24,500.00
CLS0123PO	Porcine 6-keto-prostaglandin,6-K-PG ELISA Kit	96 Test	38220090	24,500.00
CLS0124PO	Porcine 6-keto-prostaglandin F1a,6-K-PGF1a ELISA Kit	96 Test	38220090	24,500.00
CLS0125PO	Porcine 6-keto-prostaglandin F2a,6-K-PGF2a ELISA Kit	96 Test	38220090	24,500.00
CLS0126PO	Porcine 8-Hydroxy-desoxyguanosine,8-OHdG ELISA Kit	96 Test	38220090	24,500.00
CLS0127PO	Porcine 8-epi-prostaglandin F2alpha,8-epi-PGF2α ELISA Kit	96 Test	38220090	24,500.00
CLS0128PO	Porcine 8-iso prostaglandin(8-iso-PG) ELISA Kit	96 Test	38220090	24,500.00
CLS0129PO	Porcine ADAM metallopeptidase with thrombospondin type 1 motif4,ADAMTS4 ELISAkit	96 Test	38220090	24,500.00
CLS0130PO	Porcine Agouti Related Protein,AGRP ELISA Kit	96 Test	38220090	24,500.00
CLS0131PO	Porcine A kinase PRKA anchor protein-gravin 12,Akap12 ELISA Kit	96 Test	38220090	24,500.00
CLS0132PO	Porcine Bcl-2 Associated X protein,BAX ELISA Kit	96 Test	38220090	24,500.00
CLS0133PO	Porcine B-cell leukemia/lymphoma 2,Bcl-2 ELISA Kit	96 Test	38220090	24,500.00
CLS0134PO	Porcine CCAAT/enhancer binding protein epsilon,C/EBPε ELISA Kit	96 Test	38220090	24,500.00
CLS0135PO	Porcine CC-chemokine receptor 1,CCR-1 ELISA Kit	96 Test	38220090	24,500.00
CLS0136PO	Porcine CC Chemokine receptor 4,CCR-4 ELISA Kit	96 Test	38220090	24,500.00
CLS0137PO	Porcine CC Chemokine receptor 6,CCR-6 ELISA Kit	96 Test	38220090	24,500.00
CLS0138PO	Porcine CC Chemokine receptor 7,CCR-7 ELISA Kit	96 Test	38220090	24,500.00
CLS0139PO	Porcine CD163 antigen,CD163 LISA kit	96 Test	38220090	24,500.00
CLS0140PO	Porcine Cluster of differentiation 30,CD30 ELISA Kit	96 Test	38220090	24,500.00
CLS0141PO	Porcine cluster Of differentiation,CD34 ELISA Kit	96 Test	38220090	24,500.00
CLS0142PO	Porcine Cluster of differentiation 3,CD3 ELISA Kit	96 Test	38220090	24,500.00
CLS0143PO	Porcine cluster Of differentiation,CD44 ELISA Kit	96 Test	38220090	24,500.00
CLS0144PO	Porcine Cluster of differentiation 98,CD98 ELISA Kit	96 Test	38220090	24,500.00
CLS0145PO	Porcine E-Selectin ELISA kit	96 Test	38220090	24,500.00
CLS0146PO	Porcine NOD-like receptor9,NLR ELISA Kit	96 Test	38220090	24,500.00
CLS0147PO	Porcine anti-Nogo-A antibody,NOGO-A Ab ELISA Kit	96 Test	38220090	24,500.00
CLS0148PO	Porcine N-terminal extein,Ext-N ELISA Kit	96 Test	38220090	24,500.00
CLS0149PO	Porcine N-MID Osteocalcin,N-MID-OT ELISA Kit	96 Test	38220090	24,500.00
CLS0150PO	Porcine Neural-Cadherin, N-Cad ELISA kit	96 Test	38220090	24,500.00
CLS0151PO	Porcine Placenta Cadherin,P-cad ELISA Kit	96 Test	38220090	24,500.00
CLS0152PO	Porcine permeability glycoprotein,P-gp ELISA Kit	96 Test	38220090	24,500.00
CLS0153PO	Porcine Substance P,SP ELISA Kit	96 Test	38220090	24,500.00
CLS0154PO	Porcine substance P receptor,SP-R ELISA Kit	96 Test	38220090	24,500.00
CLS0155PO	Porcine platelet Selectin,P-Selectin/CD62P ELISA kit	96 Test	38220090	24,500.00

Cat.No.	Product Description	Pack Size	HSN	Unit Price
CLS0156PO	Porcine Alpha1 Antichymotrypsin,AACT ELISA Kit	96 Test	38220090	24,500.00
CLS0157PO	Porcine α1-microglobulin,α1-MG ELISA Kit	96 Test	38220090	24,500.00
CLS0158PO	Porcine alpha-1-microglobulin bikunin precursor,AMBP ELISA Kit	96 Test	38220090	24,500.00
CLS0159PO	Porcine α2 macroglobulin,α2 MG ELISA Kit	96 Test	38220090	24,500.00
CLS0160PO	Porcine α2 macroglobulin precursor,pre-α2 MG ELISA Kit	96 Test	38220090	24,500.00
CLS0161PO	Porcine α mannosidase,α Manase ELISA Kit	96 Test	38220090	24,500.00
CLS0162PO	Porcine α-sarcomeric actin,α-SCA ELISA Kit	96 Test	38220090	24,500.00
CLS0163PO	Porcine Alpha-Actin,α Actin ELISA Kit	96 Test	38220090	24,500.00
CLS0164PO	Porcine α-Endomorphin,α-EP ELISA Kit	96 Test	38220090	24,500.00
CLS0165PO	Porcinea-Glucosidase,α-Glu ELISA Kit	96 Test	38220090	24,500.00
CLS0166PO	Porcine β2-microglobulin,BMG/β2-MG ELISA Kit	96 Test	38220090	24,500.00
CLS0167PO	Porcine integrin β2,ITG β2/CD11+CD18 ELISA Kit	96 Test	38220090	24,500.00
CLS0168PO	Porcine β-hexosaminidase A,β-Hex A ELISA Kit	96 Test	38220090	24,500.00
CLS0169PO	Porcine β-galactosidase,βGAL ELISA Kit	96 Test	38220090	24,500.00
CLS0170PO	Porcine β-lipotropic hormone,β-LPH ELISA Kit	96 Test	38220090	24,500.00
CLS0171PO	Porcine amyloid beta peptide 1-40,Aβ1-40 ELISA Kit	96 Test	38220090	24,500.00
CLS0172PO	Porcine amyloid beta peptide 1-42,Aβ1-42 ELISA Kit	96 Test	38220090	24,500.00
CLS0173PO	Porcine β-Defensins,β-DF ELISA Kit	96 Test	38220090	24,500.00
CLS0174PO	Porcine Beta-defensin 1,DEFB1 ELISA kit	96 Test	38220090	24,500.00
CLS0175PO	Porcine β defensin 2,DEFB2 ELISA kit	96 Test	38220090	24,500.00
CLS0176PO	Porcine β mannosidase,β Manase ELISA Kit	96 Test	38220090	24,500.00
CLS0177PO	Porcine β catenin,β-Cat ELISA Kit	96 Test	38220090	24,500.00
CLS0178PO	Porcine Beta-Endorphin receptor,β-EPR ELISA Kit	96 Test	38220090	24,500.00
CLS0179PO	Porcine β-lactamase ELISA Kit	96 Test	38220090	24,500.00
CLS0180PO	Porcine β-Lactamase inhibitors,BLI ELISA Kit	96 Test	38220090	24,500.00
CLS0181PO	Porcine Beta-naphthol,β-Nph ELISA KIT	96 Test	38220090	24,500.00
CLS0182PO	Porcine β-glucosidase ELISA Kit	96 Test	38220090	24,500.00
CLS0183PO	Porcine β-Thromboglobulin,β-TG ELISA Kit	96 Test	38220090	24,500.00
CLS0184PO	Porcine beta-arrestin 1,ARRB1 ELISA Kit	96 Test	38220090	24,500.00
CLS0185PO	Porcine beta-arrestin 2,ARRB2 ELISA Kit	96 Test	38220090	24,500.00
CLS0186PO	Porcine beta-arrestin,ARRB ELISA Kit	96 Test	38220090	24,500.00
CLS0187PO	Porcine Gamma-aminobutyric acid,GABA ELISA Kit	96 Test	38220090	24,500.00
CLS0188PO	Porcine monocyte interferon gamma inducing factor,MIGF ELISA Kit	96 Test	38220090	24,500.00
CLS0189PO	Porcine monokine induced by interferon-gamma,MIG/CXCL9 ELISA Kit	96 Test	38220090	24,500.00
CLS0190PO	Porcine interferon-inducible protein 16,IFI16/p16 ELISA Kit	96 Test	38220090	24,500.00
CLS0191PO	Porcine γ-glutamyl cysteine synthetase,γ-ECS ELISA Kit	96 Test	38220090	24,500.00
CLS0192PO	Porcine Peptide y,Py ELISA Kit	96 Test	38220090	24,500.00
CLS0193PO	Porcine Interferon ω,IFN-ω ELISA Kit	96 Test	38220090	24,500.00
CLS0194PO	Porcine Acrine Orange,AO ELISA Kit	96 Test	38220090	24,500.00
CLS0195PO	Porcine Interleukin 18,IL-18 ELISA Kit	96 Test	38220090	24,500.00
CLS0196PO	Porcine Interleukin 1α ,IL-1α ELISA kit	96 Test	38220090	24,500.00
CLS0197PO	Porcine Interleukin 1 receptor antagonist, IL-1ra ELISA kit	96 Test	38220090	24,500.00
CLS0198PO	Porcine Interleukin 5,IL-5 ELISA KIT	96 Test	38220090	24,500.00
CLS0199PO	Porcine Interleukin 15,IL-15 ELISA Kit	96 Test	38220090	24,500.00
CLS0200PO	Porcine leukemia inhibitory factor receptor,LIFR ELISA Kit	96 Test	38220090	24,500.00
CLS0201PO	Porcine Cystatin S,Cys-S ELISA Kit	96 Test	38220090	24,500.00
CLS0202PO	Porcine Cystatin SN,Cys-SN ELISA Kit	96 Test	38220090	24,500.00
CLS0203PO	Porcine cysteinyl leukotrienes,CysLTs ELISA Kit	96 Test	38220090	24,500.00
CLS0204PO	Porcine galactose-6-sulphate sulphatase,Gal-6S ELISA Kit	96 Test	38220090	24,500.00
CLS0205PO	Porcine GALECTIN-3 ELISA Kit	96 Test	38220090	24,500.00
CLS0206PO	Porcine chaperonin 10,CPN10 ELISA Kit	96 Test	38220090	24,500.00
CLS0207PO	Porcine urinary bladder cancer antigen,UBC ELISA Kit	96 Test	38220090	24,500.00

Cat.No.	Product Description	Pack Size	HSN	Unit Price
CLS0208PO	Porcine Bladder tumor antigen,BTA ELISA Kit	96 Test	38220090	24,500.00
CLS0209PO	Porcine cytoplasmic immunoglobulin,CiG ELISA Kit	96 Test	38220090	24,500.00
CLS0210PO	Porcine Galanin,GAL ELISA Kit	96 Test	38220090	24,500.00
CLS0211PO	Porcine L-phenylalanine,LPA ELISA Kit	96 Test	38220090	24,500.00
CLS0212PO	Porcine membrane IgA,mIgA ELISA Kit	96 Test	38220090	24,500.00
CLS0213PO	Porcine membrane IgD,mIgD ELISA Kit	96 Test	38220090	24,500.00
CLS0214PO	Porcine membrane IgM,mIgM ELISA Kit	96 Test	38220090	24,500.00
CLS0215PO	Porcine Epiregulin,EPR ELISA Kit	96 Test	38220090	24,500.00
CLS0216PO	Porcine epidermal keratin,EK ELISA Kit	96 Test	38220090	24,500.00
CLS0217PO	Porcine epidermal growth factor receptor,EGFR ELISA Kit	96 Test	38220090	24,500.00
CLS0218PO	Porcine Epidermal growth factor receptor 2,HER2 ELISA Kit	96 Test	38220090	24,500.00
CLS0219PO	Porcine Cuticular Active Peptide Factor,CAPF ELISA Kit	96 Test	38220090	24,500.00
CLS0220PO	Porcine epidermal Fatty acid binding protein,E-FABP ELISA Kit	96 Test	38220090	24,500.00
CLS0221PO	Porcine epiligrin,EP ELISA Kit	96 Test	38220090	24,500.00
CLS0222PO	Porcine Alanine Aminotransferase,ALT/GPT ELISA Kit	96 Test	38220090	24,500.00
CLS0223PO	Porcine malondialchehyche,MDA ELISA Kit	96 Test	38220090	24,500.00
CLS0224PO	Porcine pyruvate kinase,PK ELISA Kit	96 Test	38220090	24,500.00
CLS0225PO	Porcine Pyruvate kinase isozymes M1/M2,M2-PK ELISA Kit	96 Test	38220090	24,500.00
CLS0226PO	Porcine pyruvate dehydrogenase-E1,PDH E1 ELISA Kit	96 Test	38220090	24,500.00
CLS0227PO	Porcine Complement 3,C3 ELISA Kit	96 Test	38220090	24,500.00
CLS0228PO	Porcine Laminin,LN ELISA Kit	96 Test	38220090	24,500.00
CLS0229PO	Porcine Intestinal trefoil factor,ITF ELISA Kit	96 Test	38220090	24,500.00
CLS0230PO	Porcine Ultra Sensitive Prostate Specific Antigen,PSA U S ELISA Kit	96 Test	38220090	24,500.00
CLS0231PO	Porcine ultra Estriol,uE3 ELISA KIT	96 Test	38220090	24,500.00
CLS0232PO	Porcine Super Oxidase Dimutase 1,SOD-1 ELISA kit	96 Test	38220090	24,500.00
CLS0233PO	Porcine Osteogenic Growth Peptide,OGP ELISA Kit	96 Test	38220090	24,500.00
CLS0234PO	Porcine maturation promoting factor,MFP ELISA Kit	96 Test	38220090	24,500.00
CLS0235PO	Porcine fibroblast growth factor 2,FGF2 ELISA Kit	96 Test	38220090	24,500.00
CLS0236PO	Porcine fibroblast growth factor-21,FGF-21 ELISA Kit	96 Test	38220090	24,500.00
CLS0237PO	Porcine fibroblast growth factor-23,FGF-23 ELISA Kit	96 Test	38220090	24,500.00
CLS0238PO	Porcine Programed Death Ligand-1,PDL1/B7-H1/CD274 ELISA Kit	96 Test	38220090	24,500.00
CLS0239PO	Porcine very late appearing antigen 4,VLA4 ELISA Kit	96 Test	38220090	24,500.00
CLS0240PO	Porcine Transmissible Gastroenteritis virus antibody,TGEV ELISA Kit	96 Test	38220090	24,500.00
CLS0241PO	Porcine Estradiol,E2 ELISA Kit	96 Test	38220090	24,500.00
CLS0242PO	Porcine Estradiol receptor,ER ELISA Kit	96 Test	38220090	24,500.00
CLS0243PO	Porcine estrogen,E ELISA Kit	96 Test	38220090	24,500.00
CLS0244PO	Porcine Estrogen Receptor,ER ELISA Kit	96 Test	38220090	24,500.00
CLS0245PO	Porcine Estrogen-induced protein pS2(EIP-PS2)ELISA Kit	96 Test	38220090	24,500.00
CLS0246PO	Porcine Estriol,E3 ELISA Kit	96 Test	38220090	24,500.00
CLS0247PO	Porcine mitogen-activated protein kinase-activated protein kinase 3,MAPKAPK3 ELISA Kit	96 Test	38220090	24,500.00
CLS0248PO	Porcine Luteinizing Hormone,LH ELISA Kit	96 Test	38220090	24,500.00
CLS0249PO	Porcine Thyroid Stimulating Hormone,TSH ELISA Kit	96 Test	38220090	24,500.00
CLS0250PO	Porcine thyrotropin-releasing hormone,TRH ELISA KIT	96 Test	38220090	24,500.00
CLS0251PO	Porcine follicle-stimulating hormone,FSH ELISA Kit	96 Test	38220090	24,500.00
CLS0252PO	Porcine corticotropin releasing hormone,CRH ELISA Kit	96 Test	38220090	24,500.00
CLS0253PO	Porcine growth hormone releasing hormone,GHRH ELISA Kit	96 Test	38220090	24,500.00
CLS0254PO	Porcine delta sleep-inducing peptide,DSIP ELISA Kit	96 Test	38220090	24,500.00
CLS0255PO	Porcine gastrin receptor,GsaR ELISA Kit	96 Test	38220090	24,500.00
CLS0256PO	Porcine gonadotropin-releasing hormone,GnRH ELISA Kit	96 Test	38220090	24,500.00
CLS0257PO	Porcine Secretin(SCT) ELISA Kit	96 Test	38220090	24,500.00

Cat.No.	Product Description	Pack Size	HSN	Unit Price
CLS0258PO	Porcine maturation promoting factor,MF/MPF ELISA Kit	96 Test	38220090	24,500.00
CLS0259PO	Porcine oxytocin,OT ELISA Kit	96 Test	38220090	24,500.00
CLS0260PO	Porcine listeriolysin O,LLO ELISA Kit	96 Test	38220090	24,500.00
CLS0261PO	Porcine cholecystokinin,CCK ELISA Kit	96 Test	38220090	24,500.00
CLS0262PO	Porcine cholecystokinin,CCK ELISA Kit	96 Test	38220090	24,500.00
CLS0263PO	Porcine low molecular weight heparin,LMWH ELISA Kit	96 Test	38220090	24,500.00
CLS0264PO	Porcine Vascular Endothelial cell Growth Factor A,VEGF-A ELISA KIT	96 Test	38220090	24,500.00
CLS0265PO	Porcine Factor-related Apoptosis,FAS ELISA Kit	96 Test	38220090	24,500.00
CLS0266PO	Porcine telomerase,TE ELISA Kit	96 Test	38220090	24,500.00
CLS0267PO	Porcine Pulmonary surfactant-associated protein A,SP-A ELISA Kit	96 Test	38220090	24,500.00
CLS0268PO	Porcine Interferon γ ,IFN- γ ELISA Kit	96 Test	38220090	24,500.00
CLS0269PO	Porcine Triglyceride,TG ELISA Kit	96 Test	38220090	24,500.00
CLS0270PO	Porcine hepatocyte growth factor,HGF ELISA Kit	96 Test	38220090	24,500.00
CLS0271PO	Porcine Testosterone,T ELISA Kit	96 Test	38220090	24,500.00
CLS0272PO	Porcine Osteocalcin/Bone gla protein,OT/BGP ELISA kit	96 Test	38220090	24,500.00
CLS0273PO	Porcine melanoma metastasis surface adhesion molecule,MMSAM ELISA Kit	96 Test	38220090	24,500.00
CLS0274PO	Porcine Activin A,ACV-A ELISA Kit	96 Test	38220090	24,500.00
CLS0275PO	Porcine tissue inhibitors of metalloproteinase 1,TIMP-1 ELISA Kit	96 Test	38220090	24,500.00
CLS0276PO	Porcine Hormone sensitive lipase(HSL)ELISA Kit	96 Test	38220090	24,500.00
CLS0277PO	Porcine macrophage inflammatory protein 1 α ,MIP-1 α ELISA Kit	96 Test	38220090	24,500.00
CLS0278PO	Porcine anti-thrombin receptor,ATR ELISA Kit	96 Test	38220090	24,500.00
CLS0279PO	Porcine Soluble Intercellular Adhesion Molecule-1,sICAM-1 ELISA Kit	96 Test	38220090	24,500.00
CLS0280PO	Porcine soluble Vascular cell adhesion molecules 1,sVCAM-1 ELISA Kit	96 Test	38220090	24,500.00
CLS0281PO	Porcine Growth Differentiation Factor 8 (GDF8)ELISA kit	96 Test	38220090	24,500.00
CLS0282PO	Porcine phospho-extracellular signal-regulated kinase,pERK ELISA Kit	96 Test	38220090	24,500.00
CLS0283PO	Porcine Phosphofructokinase,PFK ELISA Kit	96 Test	38220090	24,500.00
CLS0284PO	Porcine endothelin 1,ET-1 ELISA Kit	96 Test	38220090	24,500.00
CLS0285PO	Porcine Endothelial nitric oxide synthase,eNOS ELISA Kit	96 Test	38220090	24,500.00
CLS0286PO	Porcine Inward rectifier potassium channel 2,KCNJ2 ELISA Kit	96 Test	38220090	24,500.00
CLS0287PO	Porcine brain natriuretic peptide,BNP ELISA Kit	96 Test	38220090	24,500.00
CLS0288PO	Porcine Cortisol(COR) ELISA Kit	96 Test	38220090	24,500.00
CLS0289PO	Porcine Corticosterone,CORT ELISA Kit	96 Test	38220090	24,500.00
CLS0290PO	Porcine Glucose transporter 2,GLUT2 ELISA Kit	96 Test	38220090	24,500.00
CLS0291PO	Porcine Platelet Factor 4,PF-4 ELISA Kit	96 Test	38220090	24,500.00
CLS0292PO	Porcine Heat Shock Protein 20,HSP-20 ELISA Kit	96 Test	38220090	24,500.00
CLS0293PO	Porcine Heat Shock Protein 40,HSP-40 ELISA Kit	96 Test	38220090	24,500.00
CLS0294PO	Porcine Heat Shock Protein 70,HSP-70 ELISA Kit	96 Test	38220090	24,500.00
CLS0295PO	Porcine Heat Shock Protein 90,HSP-90 ELISA Kit	96 Test	38220090	24,500.00
CLS0296PO	Porcine secretin receptor,SR ELISA Kit	96 Test	38220090	24,500.00
CLS0297PO	Porcine Salmonella pig Antibody ELISA Kit	96 Test	38220090	24,500.00
CLS0298PO	Porcine Growth Hormone Releasing Peptide,GHRP ELISA Kit	96 Test	38220090	24,500.00
CLS0299PO	Porcine Orexin B,OX-B ELISA Kit	96 Test	38220090	24,500.00
CLS0300PO	Porcine Relaxin,RLN ELISA Kit	96 Test	38220090	24,500.00
CLS0301PO	Porcine α 1-Acid glycoprotein, α 1-AGP ELISA Kit	96 Test	38220090	24,500.00
CLS0302PO	Porcine myelin basic protein,MBP ELISA Kit	96 Test	38220090	24,500.00
CLS0303PO	Porcine Hyaluronic acid,HA ELISA Kit	96 Test	38220090	24,500.00
CLS0304PO	Porcine intercellular adhesion molecule 1,ICAM-1 ELISA Kit	96 Test	38220090	24,500.00

Cat.No.	Product Description	Pack Size	HSN	Unit Price
CLS0305PO	Porcine intercellular adhesion molecule 2,ICAM-2 ELISA Kit	96 Test	38220090	24,500.00
CLS0306PO	Porcine intercellular adhesion molecule 3,ICAM-3 ELISA Kit	96 Test	38220090	24,500.00
CLS0307PO	Porcine Apolipoprotein M,Apo-M ELISA Kit	96 Test	38220090	24,500.00
CLS0308PO	Porcine plasminogen activator inhibitor 1,PAI-1 ELISA Kit	96 Test	38220090	24,500.00
CLS0309PO	Porcine cardiac troponin I ,cTn- I ELISA Kit	96 Test	38220090	24,500.00
CLS0310PO	Porcine von Willebrand Factor,vWF ELISA Kit	96 Test	38220090	24,500.00
CLS0311PO	Porcine Vascular Endothelial cell Growth Factor,VEGF ELISA KIT	96 Test	38220090	24,500.00
CLS0312PO	Porcine Vascular cell adhesion molecule 1,VCAM-1 ELISA Kit	96 Test	38220090	24,500.00
CLS0313PO	Porcine Angiopoietin 1,ANG-1 ELISA Kit	96 Test	38220090	24,500.00
CLS0314PO	Porcine Angiopoietin 2,ANG-2 ELISA Kit	96 Test	38220090	24,500.00
CLS0315PO	Porcine tyrosine kinase with immunoglobulin-like and EGF-like domains 2,Tie-2 ELISA kit	96 Test	38220090	24,500.00
CLS0316PO	Porcine Vascular cell adhesion molecule 1,VCAM-1 ELISA kit	96 Test	38220090	24,500.00
CLS0317PO	Porcine Fibrinogen,Fbg ELISA Kit	96 Test	38220090	24,500.00
CLS0318PO	Porcine Fibrinogen Degradation Product,FDP ELISA Kit	96 Test	38220090	24,500.00
CLS0319PO	Porcine platelet activating factor,PAF ELISA Kit	96 Test	38220090	24,500.00
CLS0320PO	Porcine platelet-derived growth factor,PDGF ELISA Kit	96 Test	38220090	24,500.00
CLS0321PO	Porcine nitric oxide,NO ELISA Kit	96 Test	38220090	24,500.00
CLS0322PO	Porcine Insulin,INS ELISA Kit	96 Test	38220090	24,500.00
CLS0323PO	Porcine Insulin-like growth factor binding protein (IGFBP) ELISA Kit	96 Test	38220090	24,500.00
CLS0324PO	Porcine acetylcholine,ACH ELISA Kit	96 Test	38220090	24,500.00
CLS0325PO	Porcine acetylcholine receptor antibody,AChRab ELISA Kit	96 Test	38220090	24,500.00
CLS0326PO	Porcine B encephalitis antibody ELISA Kit	96 Test	38220090	24,500.00
CLS0327PO	Porcine Progesterone,PROG ELISA Kit	96 Test	38220090	24,500.00
CLS0328PO	Porcine apoprotein A1,apo-A1 ELISA Kit	96 Test	38220090	24,500.00
CLS0329PO	Porcine apoprotein B100,apo-B100 ELISA Kit	96 Test	38220090	24,500.00
CLS0330PO	Porcine lipoprotein α ,Lp- α ELISA Kit	96 Test	38220090	24,500.00
CLS0331PO	Porcine Adipose Triglyceride Lipase (ATGL) ELISA Kit	96 Test	38220090	24,500.00
CLS0332PO	Porcine adiponectin,ADP ELISA Kit	96 Test	38220090	24,500.00
CLS0333PO	Porcine Major acute phase proteins(MAP)ELISA Kit	96 Test	38220090	24,500.00
CLS0334PO	Porcine swine major histocompatibility complex I ,MHC I /SLA I ELISA Kit	96 Test	38220090	24,500.00
CLS0335PO	Porcine swine major histocompatibility complex II ,MHC II/SLA II ELISA Kit	96 Test	38220090	24,500.00
CLS0336PO	Porcine swine major histocompatibility complex III ,MHC III/SLA III ELISA Kit	96 Test	38220090	24,500.00
CLS0337PO	Porcine Transforming Growth factor β 2,TGF- β 2 ELISA Kit	96 Test	38220090	24,500.00
CLS0338PO	Porcine Total bile acide,TBA ELISA Kit	96 Test	38220090	24,500.00
CLS0339PO	Porcine total phospholipin(TPL)ELISA Kit	96 Test	38220090	24,500.00
CLS0340PO	Porcine Histamine,HIS ELISA Kit	96 Test	38220090	24,500.00
CLS0341PO	Porcine Tissue-type Plasminogen Actilyse,t-PA ELISA Kit	96 Test	38220090	24,500.00
CLS0342PO	Porcine Tissue factor,TF ELISA Kit	96 Test	38220090	24,500.00
CLS0343PO	Porcine Transthyretin,TTR ELISA Kit	96 Test	38220090	24,500.00
CLS0344PO	Porcine streptococcus (STR) ELISA Kit	96 Test	38220090	24,500.00
CLS0345PO	Porcine streptococcus II (STR-II) ELISA Kit	96 Test	38220090	24,500.00
CLS0346PO	Porcine diamine oxidase (DAO)ELISA Kit	96 Test	38220090	24,500.00
CLS0347PO	Porcine fatty acid binding protein,FABP4 ELISA Kit	96 Test	38220090	24,500.00
CLS0348PO	Porcine Heat Shock Protein 90kDa Alpha A1 (HSP90aA1)ELISA kit	96 Test	38220090	24,500.00
CLS0349PO	Porcine Pentosidine ELISA Kit	96 Test	38220090	24,500.00
CLS0350PO	Porcine Myostatin,MSTN ELISA Kit	96 Test	38220090	24,500.00
CLS0351PO	Porcine Urotensin II(UII) ELISA Kit	96 Test	38220090	24,500.00
CLS0352PO	Porcine dipeptidyl peptidase 4,DPP4 ELISA Kit	96 Test	38220090	24,500.00

Cat.No.	Product Description	Pack Size	HSN	Unit Price
CLS0353PO	Porcine Epithelial Cell Adhesion Molecule,Ep-CAM ELISA Kit	96 Test	38220090	24,500.00
CLS0354PO	Porcine chemokine (C-C motif) ligand 28 (CCL28) ELISA Kit	96 Test	38220090	24,500.00
CLS0355PO	Porcine Angiopoietin-like protein 4,ANGPTL4 ELISA Kit	96 Test	38220090	24,500.00
CLS0356PO	Porcine Hemoglobin subunit alpha(HBA)ELISA Kit	96 Test	38220090	24,500.00
CLS0357PO	Porcine Hemoglobin subunit beta(HBB) ELISA Kit	96 Test	38220090	24,500.00
CLS0358PO	Porcine desmogleins 1,Dsg-1 ELISA Kit	96 Test	38220090	24,500.00
CLS0359PO	Porcine Islet amyloid polypeptide,IAPP ELISA Kit	96 Test	38220090	24,500.00
CLS0360PO	Porcine Follistatin,FS ELISA Kit	96 Test	38220090	24,500.00
CLS0361PO	Porcine Platelet-Derived Growth Factor-B,PDGF-B ELISA kit	96 Test	38220090	24,500.00
CLS0362PO	Porcine Platelet-Derived Growth Factor-BB,PDGF-BB ELISA kit	96 Test	38220090	24,500.00
CLS0363PO	Porcine Ghrelin(GHRL) ELISA Kit	96 Test	38220090	24,500.00
CLS0364PO	Porcine Beclin1,BECN1 ELISA kit	96 Test	38220090	24,500.00
CLS0365PO	Porcine Chitinase-3-like Protein 1(YKL-40/CHI3L1)ELISA Kit	96 Test	38220090	24,500.00
CLS0366PO	Porcine Reactive oxygen species modulator 1(ROMO1)ELISA Kit	96 Test	38220090	24,500.00
CLS0367PO	Porcine Lymphotoxin-alpha,LTA ELISA Kit	96 Test	38220090	24,500.00
CLS0368PO	Porcine Lymphotoxin-beta,LTB ELISA Kit	96 Test	38220090	24,500.00
CLS0369PO	Porcine Interleukin 17A,IL-17A ELISA Kit	96 Test	38220090	24,500.00
CLS0370PO	Porcine Free Tri-iodothyronine Indes,Free-T3 ELISA Kit	96 Test	38220090	24,500.00
CLS0371PO	Porcine Free Thyroxine,FT4 ELISA Kit	96 Test	38220090	24,500.00
CLS0372PO	Porcine cytochrome P450 2E1,CYP2E1 ELISA Kit	96 Test	38220090	24,500.00
CLS0373PO	Porcine S100 Calcium Binding Protein A12 ,S100A12 ELISA Kit	96 Test	38220090	24,500.00
CLS0374PO	Porcine Dihydrotestosterone,DHT ELISA Kit	96 Test	38220090	24,500.00
CLS0375PO	Porcine Androgen receptor,AR ELISA Kit	96 Test	38220090	24,500.00
CLS0376PO	Porcine 17-Hydroxyprogesterone,17-OHP ELISA Kit	96 Test	38220090	24,500.00
CLS0377PO	Porcine Angiotensin converting enzyme,ACE ELISA Kit	96 Test	38220090	24,500.00
CLS0378PO	Porcine sorbitol dehydrogenase,SDH ELISA Kit	96 Test	38220090	24,500.00
CLS0379PO	Porcine cytochrome P450 7A1,CYP7A1 ELISA Kit	96 Test	38220090	24,500.00
CLS0380PO	Porcine Steroid 17-alpha-hydroxylase/17,20 lyase;Cytochrome P450 17A1,CYP17A1 ELISA Kit	96 Test	38220090	24,500.00
CLS0381PO	Porcine Neurokinins B,NKB ELISA Kit	96 Test	38220090	24,500.00
CLS0382PO	Porcine Glucose dependent insulin releasing polypeptide,GIP ELISA Kit	96 Test	38220090	24,500.00
CLS0383PO	Porcine Proinsulin,PI ELISA Kit	96 Test	38220090	24,500.00
CLS0384PO	Porcine Glycated hemoglobin A1c,GHbA1c ELISA Kit	96 Test	38220090	24,500.00
CLS0385PO	Porcine Troponin T, slow skeletal muscle(TNNT1) ELISA Kit	96 Test	38220090	24,500.00
CLS0386PO	Porcine Troponin T, slow skeletal muscle(TNNT3) ELISA Kit	96 Test	38220090	24,500.00
CLS0387PO	Porcine Neurofilament heavy polypeptide,NEFH ELISA Kit	96 Test	38220090	24,500.00
CLS0388PO	Porcine visfatin ELISA Kit	96 Test	38220090	24,500.00
CLS0389PO	Porcine Thyroxine-Binding Globulin,TBG ELISA Kit	96 Test	38220090	24,500.00
CLS0390PO	Porcine proteolipid protein,PLP ELISA Kit	96 Test	38220090	24,500.00
CLS0391PO	Porcine Interleukin 4 receptor,IL4R/CD124 ELISA Kit	96 Test	38220090	24,500.00
CLS0392PO	Porcine High mobility group protein B1,HMGB-1 ELISA Kit	96 Test	38220090	24,500.00
CLS0393PO	Porcine Sialidase-1,NEU1 ELISA Kit	96 Test	38220090	24,500.00
CLS0394PO	Porcine high mobility group protein 17,HMG-17 ELISA Kit	96 Test	38220090	24,500.00
CLS0395PO	Porcine Prostaglandin reductase 1,PTGR1 ELISA Kit	96 Test	38220090	24,500.00
CLS0396PO	Porcine ficolin 2,FCN2 ELISA Kit	96 Test	38220090	24,500.00
CLS0397PO	Porcine ficolin 1,FCN1 ELISA Kit	96 Test	38220090	24,500.00
CLS0398PO	Porcine secreted protein acidic and rich in cysteine,SPARC ELISA Kit	96 Test	38220090	24,500.00

Cat.No.	Product Description	Pack Size	HSN	Unit Price
CLS0399PO	Porcine Tumor necrosis factor receptor superfamily member 5,CD40/TNFRSF5 ELISA Kit	96 Test	38220090	24,500.00
CLS0400PO	Porcine Endothelin-1 receptor,EDNRA ELISA Kit	96 Test	38220090	24,500.00
CLS0401PO	Porcine Ryanodine receptor 1,RyR1 ELISA kit	96 Test	38220090	24,500.00
CLS0402PO	Porcine transforming growth factor β ,TGF- β ELISA Kit	96 Test	38220090	24,500.00
CLS0403PO	Porcine Fructose-1,6-bisphosphatase 1,FBP1 ELISA kit	96 Test	38220090	24,500.00
CLS0404PO	Porcine Complement fragment 5a,C5a ELISA Kit	96 Test	38220090	24,500.00
CLS0405PO	Porcine Immunoglobulin G1,IgG1 ELISA Kit	96 Test	38220090	24,500.00
CLS0406PO	Porcine Immunoglobulin G2,IgG2 ELISA Kit	96 Test	38220090	24,500.00
CLS0407PO	Porcine Pulmonary surfactant-associated protein D,SP-D ELISA Kit	96 Test	38220090	24,500.00
CLS0408PO	Porcine Pulmonary surfactant-associated protein B,SP-B ELISA Kit	96 Test	38220090	24,500.00
CLS0409PO	Porcine Pulmonary surfactant-associated protein C,SP-C ELISA Kit	96 Test	38220090	24,500.00
CLS0410PO	Porcine transferrin receptor,TFR ELISA Kit	96 Test	38220090	24,500.00
CLS0411PO	Porcine polymeric immunoglobulin receptor/secretory component,PIGR/SC ELISA Kit	96 Test	38220090	24,500.00
CLS0412PO	Porcine Heat Shock 70kDa Protein 5 (HSPA5)ELISA kit	96 Test	38220090	24,500.00
CLS0413PO	Porcine Endothelin 3,ET-3 ELISA Kit	96 Test	38220090	24,500.00
CLS0414PO	Porcine Myo-inositol oxygenase,MIOX ELISA Kit	96 Test	38220090	24,500.00
CLS0415PO	Porcine Gonadotropin-releasing hormone receptor,GnRHR ELISA Kit	96 Test	38220090	24,500.00
CLS0416PO	Porcine Gonadotropin-inhibitory hormone,GnIH ELISA Kit	96 Test	38220090	24,500.00
CLS0417PO	Porcine glial cell line-derived neurotrophic factor,GDNF ELISA KIT	96 Test	38220090	24,500.00
CLS0418PO	Porcine G protein-activated inward rectifier potassium channel 4,KCNJ5/GIRK4 ELISA Kit	96 Test	38220090	24,500.00
CLS0419PO	Porcine Deoxyribonuclease 1,DNase-1 ELISA Kit	96 Test	38220090	24,500.00
CLS0420PO	Porcine Deoxyribonuclease-2-alpha,DNASE2A ELISA Kit	96 Test	38220090	24,500.00
CLS0421PO	Porcine Deoxyribonuclease-1-like 1,DNASE1L1 ELISA Kit	96 Test	38220090	24,500.00
CLS0422PO	Porcine Isocitrate dehydrogenase [NADP] cytoplasmic(IDH1) ELISA Kit	96 Test	38220090	24,500.00
CLS0423PO	Porcine Isocitrate dehydrogenase [NADP] mitochondrial(IDH2) ELISA Kit	96 Test	38220090	24,500.00
CLS0424PO	Porcine Perilipin-2(PLIN2)ELISA kit	96 Test	38220090	24,500.00
CLS0425PO	Porcine Oxidized low-density lipoprotein receptor 1,OLR1/LOX1 ELISA kit	96 Test	38220090	24,500.00
CLS0426PO	Porcine Glucagon,GC ELISA Kit	96 Test	38220090	24,500.00
CLS0427PO	Porcine Rho Guanine Nucleotide Exchange Factor 2(ARHGEF2)ELISA Kit	96 Test	38220090	24,500.00
CLS0428PO	Porcine Hemopexin,HPX ELISA kit	96 Test	38220090	24,500.00
CLS0429PO	Porcine Selenide, water dikinase 2,SEPHS2 ELISA kit	96 Test	38220090	24,500.00
CLS0430PO	Porcine Glucose transporter 1,GLUT1/SLC2A1 ELISA Kit	96 Test	38220090	24,500.00
CLS0431PO	Porcine Calpastatin/Calpain inhibitor,CAST ELISA Kit	96 Test	38220090	24,500.00
CLS0432PO	Porcine Glucose-6-phosphate isomerase,GPI ELISA Kit	96 Test	38220090	24,500.00
CLS0433PO	Porcine Signal transducer and activator of transcription 1,STAT1 ELISA Kit	96 Test	38220090	24,500.00
CLS0434PO	Porcine Gastrin,GAS ELISA Kit	96 Test	38220090	24,500.00
CLS0435PO	Porcine Transferrin(TRF)ELISA Kit	96 Test	38220090	24,500.00
CLS0436PO	Porcine Alpha-Synuclein,SNCA ELISA Kit	96 Test	38220090	24,500.00
CLS0437PO	Porcine Complement factor D/Adipsin,CFD ELISA Kit	96 Test	38220090	24,500.00
CLS0438PO	Porcine Gelsolin,GS ELISA Kit	96 Test	38220090	24,500.00
CLS0439PO	Porcine Interleukin 6 receptor,IL6R ELISA Kit	96 Test	38220090	24,500.00
CLS0440PO	Porcine Alpha-1B-glycoprotein,A1BG ELISA Kit	96 Test	38220090	24,500.00
CLS0441PO	Porcine vitronectin,VNR ELISA Kit	96 Test	38220090	24,500.00
CLS0442PO	Porcine Fetuin A,FETU-A ELISA Kit	96 Test	38220090	24,500.00
CLS0443PO	Porcine Estrogen Receptor beta,ER-beta ELISA Kit	96 Test	38220090	24,500.00
CLS0444PO	Porcine Pancreatic triacylglycerol lipase,PNLIP ELISA Kit	96 Test	38220090	24,500.00

Cat.No.	Product Description	Pack Size	HSN	Unit Price
CLS0445PO	Porcine Lactoferrin,LTF/LF ELISA kit	96 Test	38220090	24,500.00
CLS0446PO	Porcine Annexin A1 (ANXA1)ELISA Kit	96 Test	38220090	24,500.00
CLS0447PO	Porcine Annexin A4 (ANXA4)ELISA Kit	96 Test	38220090	24,500.00
CLS0448PO	Porcine F-box only protein 32,FBXO32/MAFbx ELISA Kit	96 Test	38220090	24,500.00
CLS0449PO	Porcine Cysteinyl aspartate specific proteinases 3,Caspase-3/PPP32 ELISA Kit	96 Test	38220090	24,500.00
CLS0450PO	Porcine Glutamate oxaloacetate transaminase 1,GOT1 ELISA Kit	96 Test	38220090	24,500.00
CLS0451PO	Porcine Fibrillin-1,FBN1 ELISA Kit	96 Test	38220090	24,500.00
CLS0452PO	Porcine TGF-beta receptor type-1,TGFBR1 ELISA Kit	96 Test	38220090	24,500.00
CLS0453PO	Porcine Neuromedin U (NMU)ELISA kit	96 Test	38220090	24,500.00
CLS0454PO	Porcine brucella antibody IgG(brucella Ab IgG)ELISA Kit	96 Test	38220090	24,500.00
CLS0455PO	Porcine Amelogenin(AMEL)ELISA Kit	96 Test	38220090	24,500.00
CLS0456PO	Porcine Circovirus(PCV2)ELISA Kit	96 Test	38220090	24,500.00
CLS0457PO	Porcine Procollagen Type I Intact N-terminal Propeptide(P1NP)ELISA Kit	96 Test	38220090	24,500.00
CLS0458PO	Porcine Japanese Encephalitis Virus Antibody ELISA Kit	96 Test	38220090	24,500.00
CLS0001MO	Mouse Succinate receptor 1(SUCNR1)ELISA Kit	96 Test	38220090	24,500.00
CLS0002MO	Mouse Cytochrome-C,Cyt-C ELISA Kit	96 Test	38220090	24,500.00
CLS0003MO	Mouse lipid peroxide(LPO)ELISA Kit	96 Test	38220090	24,500.00
CLS0004MO	Mouse Proto-oncogene Wnt-1(WNT1)ELISA Kit	96 Test	38220090	24,500.00
CLS0005MO	Mouse Protein Wnt-3a(WNT3A)ELISA Kit	96 Test	38220090	24,500.00
CLS0006MO	Mouse Vitamin D,VD ELISA Kit	96 Test	38220090	24,500.00
CLS0007MO	Mouse A Disintegrin And Metalloprotease 17 (ADAM17)ELISA Kit	96 Test	38220090	24,500.00
CLS0008MO	Mouse diacyl glycerol,DAG/DG ELISA kit	96 Test	38220090	24,500.00
CLS0009MO	Mouse Microtubule Associated Protein Tau(MAPT)ELISA Kit	96 Test	38220090	24,500.00
CLS0010MO	Mouse Nad-Dependent Protein Deacetylase Sirtuin-1(SIRT1)ELISA Kit	96 Test	38220090	24,500.00
CLS0011MO	Mouse lipoprotein lipase,LPL ELISA Kit	96 Test	38220090	24,500.00
CLS0012MO	Mouse Hydroxymethylglutaryl CoA Reductase(MHG-CoAR)ELISA Kit	96 Test	38220090	24,500.00
CLS0013MO	Mouse uncoupling protein 1, UCP1 ELISA Kit	96 Test	38220090	24,500.00
CLS0014MO	Mouse Interleukin 4,IL-4 ELISA Kit	96 Test	38220090	24,500.00
CLS0015MO	Mouse Insulin,INS ELISA Kit	96 Test	38220090	24,500.00
CLS0016MO	Mouse Undercarboxylated Osteocalcin (ucOC) ELISA Kit	96 Test	38220090	24,500.00
CLS0017MO	Mouse advanced oxidation protein products,AOPP ELISA Kit	96 Test	38220090	24,500.00
CLS0018MO	Mouse Beta-defensin 4,DEFB4 ELISA kit	96 Test	38220090	24,500.00
CLS0019MO	Mouse Glucocorticoid(GC)ELISA Kit	96 Test	38220090	24,500.00
CLS0020MO	Mouse Vascular Endothelial cell Growth Factor,VEGF ELISA Kit	96 Test	38220090	24,500.00
CLS0021MO	Mouse Low Density Lipoprotein Receptor Related Protein 1 (LRP1)ELISA kit	96 Test	38220090	24,500.00
CLS0022MO	Mouse Receptor for advanced glycation end products, RAGE/AGER ELISA Kit	96 Test	38220090	24,500.00
CLS0023MO	Mouse phospho Tau Protein(pr)ELISA Kit	96 Test	38220090	24,500.00
CLS0024MO	Mouse Beta-Site APP Cleaving Enzyme 1(bACE1)ELISA Kit	96 Test	38220090	24,500.00
CLS0025MO	Mouse total Tau Proteins(tr)ELISA Kit	96 Test	38220090	24,500.00
CLS0026MO	Mouse Troponin I ,Tn- I ELISA Kit	96 Test	38220090	24,500.00
CLS0027MO	Mouse C-Reactive Protein,CRP ELISA Kit	96 Test	38220090	24,500.00
CLS0028MO	Mouse luteotropic hormone(LH)ELISA Kit	96 Test	38220090	24,500.00
CLS0029MO	Mouse Mullerian Inhibiting Substance/Anti-Mullerian hormone,MIS/AMH ELISA Kit	96 Test	38220090	24,500.00
CLS0030MO	Mouse estrogen,E ELISA Kit	96 Test	38220090	24,500.00
CLS0031MO	Mouse Progesterone,PROG ELISA Kit	96 Test	38220090	24,500.00
CLS0032MO	Mouse Endothelial cell-specific molecule 1,ESM-1 ELISA kit	96 Test	38220090	24,500.00

Cat.No.	Product Description	Pack Size	HSN	Unit Price
CLS0033MO	Mouse Super Oxidase Dimutase,SOD ELISA Kit	96 Test	38220090	24,500.00
CLS0034MO	Mouse oxidized lowdensity lipoprotein,OxLDL ELISA Kit	96 Test	38220090	24,500.00
CLS0035MO	Mouse pyruvate dehydrogenase-E1,PDH E1 ELISA Kit	96 Test	38220090	24,500.00
CLS0036MO	Mouse Isocitrate dehydrogenase [NADP] cytoplasmic(IDH1) ELISA Kit	96 Test	38220090	24,500.00
CLS0037MO	Mouse phosphoenolpyruvate carboxykinase,PCK ELISA Kit	96 Test	38220090	24,500.00
CLS0038MO	Mouse glucokinase,GCK ELISA Kit	96 Test	38220090	24,500.00
CLS0039MO	Mouse Phosphofructokinase,PFK ELISA Kit	96 Test	38220090	24,500.00
CLS0040MO	Mouse 6-phosphofructokinase, liver type(PFKL)ELISA kit	96 Test	38220090	24,500.00
CLS0041MO	Mouse Malic Enzyme(ME)ELISA Kit	96 Test	38220090	24,500.00
CLS0042MO	Mouse Protein Kinase C alpha(PKCα)ELISA Kit	96 Test	38220090	24,500.00
CLS0043MO	Mouse cyclophilin B,CyPB ELISA Kit	96 Test	38220090	24,500.00
CLS0044MO	Mouse Prostaglandin E2,PG-E2 ELISA Kit	96 Test	38220090	24,500.00
CLS0045MO	Mouse Interleukin 23,IL-23 ELISA Kit	96 Test	38220090	24,500.00
CLS0046MO	Mouse Beta-defensin 1,DEFB1 ELISA kit	96 Test	38220090	24,500.00
CLS0047MO	Mouse Interleukin 22,IL-22 ELISA kit	96 Test	38220090	24,500.00
CLS0048MO	Mouse Kidney injury molecule 1,Kim-1 ELISA Kit	96 Test	38220090	24,500.00
CLS0049MO	Mouse β2-microglobulin,BMG/β2-MG ELISA Kit	96 Test	38220090	24,500.00
CLS0050MO	Mouse aldose reductase(AR)ELISA Kit	96 Test	38220090	24,500.00
CLS0051MO	Mouse Acylamino-acid-releasing enzyme(APEH)ELISA Kit	96 Test	38220090	24,500.00
CLS0052MO	Mouse Cerebral Dopamine Neurotrophic Factor(CDNF)ELISA Kit	96 Test	38220090	24,500.00
CLS0053MO	Mouse Testosterone,T ELISA Kit	96 Test	38220090	24,500.00
CLS0054MO	Mouse Luteinizing Hormone,LH ELISA Kit	96 Test	38220090	24,500.00
CLS0055MO	mouse follicle-stimulating hormone,FSH ELISA Kit	96 Test	38220090	24,500.00
CLS0056MO	Mouse Cathepsin K (CTSK) ELISA Kit	96 Test	38220090	24,500.00
CLS0057MO	Mouse α-amylase(AMY)ELISA Kit	96 Test	38220090	24,500.00
CLS0058MO	Mouse Pepsin,PP ELISA Kit	96 Test	38220090	24,500.00
CLS0059MO	Mouse trypsin ELISA Kit	96 Test	38220090	24,500.00
CLS0060MO	Mouse Retinoic X receptor gamma(RXRg)ELISA Kit	96 Test	38220090	24,500.00
CLS0061MO	Mouse Retinoic X receptor beta(RXRb)ELISA Kit	96 Test	38220090	24,500.00
CLS0062MO	Mouse Retinoic acid receptor gamma(RARG)ELISA Kit	96 Test	38220090	24,500.00
CLS0063MO	Mouse Retinoic acid receptor beta(RARB)ELISA Kit	96 Test	38220090	24,500.00
CLS0064MO	Mouse Glycogen synthase kinase-3 beta,Gsk3b ELISA Kit	96 Test	38220090	24,500.00
CLS0065MO	Mouse Transcription Factor/Activator Protein 1(AP-1)ELISA Kit	96 Test	38220090	24,500.00
CLS0066MO	Mouse Hypoxia Up Regulated 1 (HYOU1)ELISA kit	96 Test	38220090	24,500.00
CLS0067MO	Mouse Brain derived neurotrophic factor,BDNF ELISA Kit	96 Test	38220090	24,500.00
CLS0068MO	Mouse monoamine oxidase B(MAOB)ELISA Kit	96 Test	38220090	24,500.00
CLS0069MO	Mouse Tyrosine Hydroxylase(TH)ELISA Kit	96 Test	38220090	24,500.00
CLS0070MO	Mouse Lamin-B1(LMNB1)ELISA Kit	96 Test	38220090	24,500.00
CLS0071MO	Mouse NAD Kinase(NADK)ELISA Kit	96 Test	38220090	24,500.00
CLS0072MO	Mouse interleukin 8,IL-8 ELISA Kit	96 Test	38220090	24,500.00
CLS0073MO	Mouse Cross-linked Carboxy-terminal telopeptide of type I collagen, I CTP ELISA Kit	96 Test	38220090	24,500.00
CLS0074MO	Mouse NADPH oxidase 1(NOX1)ELISA Kit	96 Test	38220090	24,500.00
CLS0075MO	Mouse Tryptophan Hydroxylase 2(TPH2)ELISA	96 Test	38220090	24,500.00
CLS0076MO	Mouse nitric oxide,NO ELISA Kit	96 Test	38220090	24,500.00
CLS0077MO	Mouse Endothelial nitric oxide synthase,eNOS ELISA Kit	96 Test	38220090	24,500.00
CLS0078MO	Mouse 5-Hydroxytryptophan(5-HTP)ELISA Kit	96 Test	38220090	24,500.00
CLS0079MO	Mouse Nuclear factor-kappa B,NF-κB ELISA Kit	96 Test	38220090	24,500.00
CLS0080MO	Mouse Glutathione peroxidase,GSH-Px ELISA Kit	96 Test	38220090	24,500.00
CLS0081MO	Mouse Cysteinyl aspartate specific proteinases 3,Caspase-3/ CPP32 ELISA Kit	96 Test	38220090	24,500.00
CLS0082MO	Mouse Atrial Natriuretic Peptide,ANP ELISA Ki	96 Test	38220090	24,500.00
CLS0083MO	Mouse Soluble protein-100,S-100 ELISA Kit	96 Test	38220090	24,500.00
CLS0084MO	Mouse Acetylcholinesterase,AChE ELISA Kit	96 Test	38220090	24,500.00
CLS0085MO	Mouse Cyclin-dependent kinase 4,CDK-4 ELISA Kit	96 Test	38220090	24,500.00

Cat.No.	Product Description	Pack Size	HSN	Unit Price
CLS0086MO	Mouse glutamic acid decarboxylase(GAD)ELISA Kit	96 Test	38220090	24,500.00
CLS0087MO	Mouse growth arrest-specific gene-6,gas-6 ELISA Kit	96 Test	38220090	24,500.00
CLS0088MO	Mouse Sestrin 3(SES3)ELISA Kit	96 Test	38220090	24,500.00
CLS0089MO	Mouse Sestrin 2(SES2)ELISA Kit	96 Test	38220090	24,500.00
CLS0090MO	Mouse Anti-nuclear Antibody,ANA ELISA Kit	96 Test	38220090	24,500.00
CLS0091MO	Mouse Macrophage Inflammatory Protein 2,MIP-2 ELISA kit	96 Test	38220090	24,500.00
CLS0092MO	Mouse muscarinic acetylcholine receptor M3,M-AChR M3 ELISA Kit	96 Test	38220090	24,500.00
CLS0093MO	Mouse Carboxymethyl lysine(CML)ELISA Kit	96 Test	38220090	24,500.00
CLS0094MO	Mouse Transforming Growth Factor Beta 3 (TGFβ3) ELISA kit	96 Test	38220090	24,500.00
CLS0095MO	Mouse Adropin,AD ELISA kit	96 Test	38220090	24,500.00
CLS0096MO	Mouse Interferon γ ,IFN-γ ELISA Kit	96 Test	38220090	24,500.00
CLS0097MO	Mouse Tumor necrosis factor α(TNF-α)ELISA Kit	96 Test	38220090	24,500.00
CLS0098MO	Mouse interleukin 12,IL-12/P40 ELISA KIT	96 Test	38220090	24,500.00
CLS0099MO	Mouse Interleukin 3,IL-3 ELISA KIT	96 Test	38220090	24,500.00
CLS0100MO	Mouse Interleukin-7,IL-7 ELISA kit	96 Test	38220090	24,500.00
CLS0101MO	Mouse Monocarboxylate Transporter-1(MCT-1)ELISA Kit	96 Test	38220090	24,500.00
CLS0102MO	Mouse KI-67(KI-67)ELISA Kit	96 Test	38220090	24,500.00
CLS0103MO	Mouse Tyrosinase(TYR)ELISA Kit	96 Test	38220090	24,500.00
CLS0104MO	Mouse very low density lipoprotein(VLDL)ELISA Kit	96 Test	38220090	24,500.00
CLS0105MO	Mouse Soluble Cluster of differentiation 40 ligand,sCD40L ELISA Kit	96 Test	38220090	24,500.00
CLS0106MO	Mouse Glucose Transporter 1(GLUT-1)ELISA Kit	96 Test	38220090	24,500.00
CLS0107MO	Mouse Phospho Fructo Kinase 1(PFK-1)ELISA	96 Test	38220090	24,500.00
CLS0108MO	Mouse Monocyte chemotactic protein 1(MCP-1)ELISA Kit	96 Test	38220090	24,500.00
CLS0109MO	Mouse Interleukin 18,IL-18 ELISA Kit	96 Test	38220090	24,500.00
CLS0110MO	Mouse Sclerostin(SOST)ELISA Kit	96 Test	38220090	24,500.00
CLS0111MO	Mouse Histamine,HIS ELISA Kit	96 Test	38220090	24,500.00
CLS0112MO	Mouse Immunoglobulin G,IgG ELISA Kit	96 Test	38220090	24,500.00
CLS0113MO	Mouse Transforming growth factor β,TGF-β ELISA Kit	96 Test	38220090	24,500.00
CLS0114MO	Mouse SH3 domain-containing YSC84-like protein 1(SH3YL1)ELISA Kit	96 Test	38220090	24,500.00
CLS0115MO	Mouse Cortisol(COR) ELISA Kit	96 Test	38220090	24,500.00
CLS0116MO	Mouse Interleukin 12,IL-12/P70 ELISA Kit	96 Test	38220090	24,500.00
CLS0117MO	Mouse interleukin 10,IL-10 ELISA Kit	96 Test	38220090	24,500.00
CLS0118MO	Mouse platelet-derived growth factor,PDGF ELISA Kit	96 Test	38220090	24,500.00
CLS0119MO	Mouse Urotensin II(UII) ELISA Kit	96 Test	38220090	24,500.00
CLS0120MO	Mouse Homocysteine,Hcy ELISA Kit	96 Test	38220090	24,500.00
CLS0121MO	Mouse Luteinizing Hormone-Releasing Hormone,LHRH ELISA Kit	96 Test	38220090	24,500.00
CLS0122MO	Mouse CXC-chemokine ligand 1(CXCL1/KC)ELISA Kit	96 Test	38220090	24,500.00
CLS0123MO	Mouse Cathepsin G(CTSG)ELISA Kit	96 Test	38220090	24,500.00
CLS0124MO	Mouse Macrophage metalloelastase(MMP12)ELISA Kit	96 Test	38220090	24,500.00
CLS0125MO	Mouse Eotaxin 2(CCL24) ELISA Kit	96 Test	38220090	24,500.00
CLS0126MO	Mouse Nuclear respiratory factor 1,NRF1 ELISA Kit	96 Test	38220090	24,500.00
CLS0127MO	Mouse Nuclear factor erythroid 2-related factor 2,NRF2 ELISA kit	96 Test	38220090	24,500.00
CLS0128MO	Mouse Peroxisome Proliferator-activated receptor γ,PPAR-γ ELISA Kit	96 Test	38220090	24,500.00
CLS0129MO	Mouse platelet-derived growth factor,PDGF ELISA Kit	96 Test	38220090	24,500.00
CLS0130MO	Mouse β2 macroglobulin(β2-MG)ELISA Kit	96 Test	38220090	24,500.00
CLS0131MO	Mouse cartilage oligomeric matrix protein,COMP ELISA Kit	96 Test	38220090	24,500.00
CLS0132MO	Mouse Capase 9(CASP9)ELISA Kit	96 Test	38220090	24,500.00
CLS0133MO	Mouse Capase 7(CASP7)ELISA Kit	96 Test	38220090	24,500.00
CLS0134MO	Mouse Capase 3(CASP3)ELISA Kit	96 Test	38220090	24,500.00
CLS0135MO	Mouse Capase 11(CASP11)ELISA Kit	96 Test	38220090	24,500.00

Cat.No.	Product Description	Pack Size	HSN	Unit Price
CLS0136MO	Mouse Capase 10(CASP10)ELISA Kit	96 Test	38220090	24,500.00
CLS0137MO	Mouse matrix metalloproteinase 1,MMP-1 ELISA kit	96 Test	38220090	24,500.00
CLS0138MO	Mouse Podocalyxin,PCX ELISA Kit	96 Test	38220090	24,500.00
CLS0139MO	Mouse Nephryn,NPHS1 ELISA Kit	96 Test	38220090	24,500.00
CLS0140MO	Mouse Heremans Schmid Glycoprotein Alpha 2,HSGa ELISA Kit	96 Test	38220090	24,500.00
CLS0141MO	Mouse α2 macroglobulin(α2-MG)ELISA Kit	96 Test	38220090	24,500.00
CLS0142MO	Mouse Haptoglobin precursor(Pre-Hpt)ELISA Kit	96 Test	38220090	24,500.00
CLS0143MO	Mouse Gamma-aminobutyric acid,GABA ELISA Kit	96 Test	38220090	24,500.00
CLS0144MO	Mouse glutamic acid decarboxylase autoantibody(GAD-Ab)ELISA Kit	96 Test	38220090	24,500.00
CLS0145MO	Mouse peroxisome proliferator-activated receptor γ coactivator-1α(PGC-1α)ELISA Kit	96 Test	38220090	24,500.00
CLS0146MO	Mouse Carbohydrate Antigen 125 (CA125)ELISA kit	96 Test	38220090	24,500.00
CLS0147MO	Mouse 8-Hydroxy-desoxyguanosine,8-OHdG ELISA Kit	96 Test	38220090	24,500.00
CLS0148MO	Mouse cardiac isoform of Troponin T,cTnT ELISA Kit	96 Test	38220090	24,500.00
CLS0149MO	Mouse β secretase(β-secretase)ELISA Kit	96 Test	38220090	24,500.00
CLS0150MO	Mouse Granulocyte-Macrophage Colony Stimulating Factor,GM-CSF ELISA kit	96 Test	38220090	24,500.00
CLS0151MO	Mouse Immunoglobulin M,IgM ELISA Kit	96 Test	38220090	24,500.00
CLS0152MO	Mouse Interleukin 1β,IL-1β ELISA Kit	96 Test	38220090	24,500.00
CLS0153MO	Mouse Interleukin 6,IL-6 ELISA Kit	96 Test	38220090	24,500.00
CLS0154MO	Mouse Protein Induced Vitamin K Absence or Antagonist-II (PIVKA-II)ELISA Kit	96 Test	38220090	24,500.00
CLS0155MO	Mouse C-X-C motif chemokine 9(CXCL9)ELISA Kit	96 Test	38220090	24,500.00
CLS0156MO	Mouse C-C motif chemokine 4(CCL4) ELISA kit	96 Test	38220090	24,500.00
CLS0157MO	Mouse Stem cell factor/mast cell growth factor,SCF/MGF ELISA kit	96 Test	38220090	24,500.00
CLS0158MO	Mouse Liver Type Fatty Acid Binding Protein(L-FABP)ELISA Kit	96 Test	38220090	24,500.00
CLS0159MO	Mouse Fatty acid-binding proteins(FABP)ELISA Kit	96 Test	38220090	24,500.00
CLS0160MO	Mouse transforming growth factorβ2,TGFβ2 ELISA Kit	96 Test	38220090	24,500.00
CLS0161MO	Mouse Insulin-like growth factor(IGF)binding protein 5(IGFBP5)ELISA Kit	96 Test	38220090	24,500.00
CLS0162MO	Mouse Insulin Like Growth Factor Binding Protein 4(IGFBP4)ELISA kit	96 Test	38220090	24,500.00
CLS0163MO	Mouse Insulin Like Growth Factor Binding Protein 3 (IGFBP3)ELISA KIT	96 Test	38220090	24,500.00
CLS0164MO	Mouse growth hormone releasing hormone,GHRH ELISA Kit	96 Test	38220090	24,500.00
CLS0165MO	Mouse Tumor necrosis factor β,TNF-β ELISA KIT	96 Test	38220090	24,500.00
CLS0166MO	Mouse hydroxyproline,Hyp ELISA Kit	96 Test	38220090	24,500.00
CLS0167MO	Mouse glutathione(GSH)ELISA Kit.doc	96 Test	38220090	24,500.00
CLS0168MO	Mouse myeloperoxidase-antineutrophil cytoplasmic antibody IgG(MPO-ANCA IgG)ELISA Kit	96 Test	38220090	24,500.00
CLS0169MO	Mouse Coronin 1A(CORO1A)ELISA Kit	96 Test	38220090	24,500.00
CLS0170MO	Mouse growth hormone,GH ELISA KIT	96 Test	38220090	24,500.00
CLS0171MO	Mouse Osteocalcin/Bone gla protein,OT/BGP ELISA kit	96 Test	38220090	24,500.00
CLS0172MO	Mouse cross linked N-telopeptide of type I collagen,NTX	96 Test	38220090	24,500.00
CLS0173MO	Mouse intercellular adhesion molecule 1,ICAM-1 ELISA KIT	96 Test	38220090	24,500.00
CLS0174MO	Mouse thrombospondin 1,TSP-1 ELISA Kit	96 Test	38220090	24,500.00
CLS0175MO	Mouse Leptin,LEP ELISA kit	96 Test	38220090	24,500.00
CLS0176MO	Mouse adiponectin,ADP ELISA Kit	96 Test	38220090	24,500.00
CLS0177MO	Mouse Fibroblast Growth Factor 15 (FGF15)ELISA kit	96 Test	38220090	24,500.00
CLS0178MO	Mouse Growth Differentiation Factor 11 (GDF11)ELISA kit	96 Test	38220090	24,500.00
CLS0179MO	Mouse dopamine,DA ELISA Kit	96 Test	38220090	24,500.00
CLS0180MO	Mouse advanced glycation end products,AGEs ELISA Kit	96 Test	38220090	24,500.00

Cat.No.	Product Description	Pack Size	HSN	Unit Price
CLS0181MO	Mouse C-telopeptide of type I collagen(CTX-I)ELISA Kit	96 Test	38220090	24,500.00
CLS0182MO	Mouse Cathepsin B,cath-B ELISA Kit	96 Test	38220090	24,500.00
CLS0183MO	Mouse Vitamin B12,VB12 ELISA Kit	96 Test	38220090	24,500.00
CLS0184MO	Mouse von Willebrand Factor,vWF ELISA Kit	96 Test	38220090	24,500.00
CLS0185MO	Mouse β -Defensins, β -DF ELISA Kit	96 Test	38220090	24,500.00
CLS0186MO	Mouse Interleukin 1 Receptor 2 (IL1R2) ELISA Kit	96 Test	38220090	24,500.00
CLS0187MO	Mouse tryptase,TPS ELISA Kit	96 Test	38220090	24,500.00
CLS0188MO	Mouse Galectin 9 (GAL9) ELISA kit	96 Test	38220090	24,500.00
CLS0189MO	Mouse mucin-5 subtype B,MUC5B ELISA kit	96 Test	38220090	24,500.00
CLS0190MO	Mouse adrenomedullin,ADM ELISA Kit	96 Test	38220090	24,500.00
CLS0191MO	Mouse calcitonin gene related peptide,CGRP ELISA Kit	96 Test	38220090	24,500.00
CLS0192MO	Mouse Adenosine triphosphate(ATP) ELISA Kit	96 Test	38220090	24,500.00
CLS0193MO	Mouse Vascular Endothelial cell Growth Factor D,VEGF-D ELISA kit	96 Test	38220090	24,500.00
CLS0194MO	Mouse Vascular Endothelial cell Growth Factor C,VEGF-C ELISA kit	96 Test	38220090	24,500.00
CLS0195MO	Mouse heme oxygenase 1,HO-1 ELISA Kit	96 Test	38220090	24,500.00
CLS0196MO	Mouse plasmin-antiplasmin complex,PAP ELISA Kit	96 Test	38220090	24,500.00
CLS0197MO	Mouse angiotensin II,ANG-II ELISA Kit	96 Test	38220090	24,500.00
CLS0198MO	Mouse Vascular adhesion protein-1,VAP-1/AOC3 ELISA Kit	96 Test	38220090	24,500.00
CLS0199MO	Mouse 4-aminobutyrate aminotransferase,mitochondrial(ABAT)ELISA Kit	96 Test	38220090	24,500.00
CLS0200MO	Mouse Lipoxin A4,LXA4 ELISA Kit	96 Test	38220090	24,500.00
CLS0201MO	Mouse Protein Wnt-5a(WNT5A)ELISA Kit	96 Test	38220090	24,500.00
CLS0202MO	Mouse Protein Wnt-4(WNT4)ELISA Kit	96 Test	38220090	24,500.00
CLS0203MO	Mouse prostacycline(PGI2)ELISA Kit	96 Test	38220090	24,500.00
CLS0204MO	Mouse Prostaglandin D2(PGD2)ELISA Kit	96 Test	38220090	24,500.00
CLS0205MO	Mouse Leukotriene C4,LT-C4 ELISA Kit	96 Test	38220090	24,500.00
CLS0206MO	Mouse cytochrome P450 2E1,CYP2E1 ELISA Kit	96 Test	38220090	24,500.00
CLS0207MO	Mouse Bone Morphogenetic Protein 7 (BMP7)ELISA kit	96 Test	38220090	24,500.00
CLS0208MO	Mouse neutrophil gelatinase-associated lipocalin,NGAL ELISA Kit	96 Test	38220090	24,500.00
CLS0209MO	Mouse DNA(cytosine-5)-methyltransferase 3-like(DNMT3L)ELISA Kit	96 Test	38220090	24,500.00
CLS0210MO	Mouse Serum amyloid A,SAA ELISA Kit	96 Test	38220090	24,500.00
CLS0211MO	Mouse Protein S100-B(S100B)ELISA Kit	96 Test	38220090	24,500.00
CLS0212MO	Mouse tartrate-resistant acid phosphatase 5b,TRACP-5b ELISA Kit	96 Test	38220090	24,500.00
CLS0213MO	Mouse Lipase, Gastric (LIPF)ELISA kit	96 Test	38220090	24,500.00
CLS0214MO	Mouse pyridinoline(Pyd)ELISA Kit	96 Test	38220090	24,500.00
CLS0215MO	Mouse bone-specific alkaline phosphatase(BAP)ELISA Kit	96 Test	38220090	24,500.00
CLS0216MO	Mouse E-Cadherin,E-Cad ELISA Kit	96 Test	38220090	24,500.00
CLS0217MO	Mouse Immunoglobulin G2a(IgG2A)ELISA Kit	96 Test	38220090	24,500.00
CLS0218MO	Mouse Collagen Type III,Col III ELISA KIT	96 Test	38220090	24,500.00
CLS0219MO	Mouse Progesterone receptor,PGR ELISA kit	96 Test	38220090	24,500.00
CLS0220MO	Mouse thyroid stimulating hormone receptor antibody,TRAb ELISA Kit	96 Test	38220090	24,500.00
CLS0221MO	Mouse Cholecystokinin,CCK ELISA Kit	96 Test	38220090	24,500.00
CLS0222MO	Mouse Peroxisome proliferator-activated receptor gamma coactivator 1 alpha(PGC1 α)ELISA Kit	96 Test	38220090	24,500.00
CLS0223MO	Mouse neutrophil elastase,NE ELISA Kit	96 Test	38220090	24,500.00
CLS0224MO	Mouse aldosterone,ALD ELISA Kit	96 Test	38220090	24,500.00
CLS0225MO	Mouse Acetyl-CoA Acetyltransferase 1(ACAT1)ELISA Kit	96 Test	38220090	24,500.00
CLS0226MO	Mouse 1,5-Anhydroglucitol (1,5-AG)ELISA kit	96 Test	38220090	24,500.00
CLS0227MO	Mouse 1-Malondialdehyde(1-Malondialdehyde)ELISA Kit	96 Test	38220090	24,500.00
CLS0228MO	Mouse Paraoxonase(PON)ELISA Kit	96 Test	38220090	24,500.00
CLS0229MO	Mouse Paraoxonase-1,PON1 ELISA Kit	96 Test	38220090	24,500.00
CLS0230MO	Mouse Toll-like receptor 2,TLR2 ELISA Kit	96 Test	38220090	24,500.00

Cat.No.	Product Description	Pack Size	HSN	Unit Price
CLS0231MO	Mouse Interleukin 1 α ,IL-1 α ELISA kit	96 Test	38220090	24,500.00
CLS0232MO	Mouse Interleukin 1,IL-1 ELISA Kit	96 Test	38220090	24,500.00
CLS0233MO	Mouse Calprotectin(CALP)ELISA Kit	96 Test	38220090	24,500.00
CLS0234MO	Mouse Platelet-Derived Growth Factor AB,PDGF-AB ELISA kit	96 Test	38220090	24,500.00
CLS0235MO	Mouse high sensitivity C-Reactive Protein,hs-CRP ELISA Kit	96 Test	38220090	24,500.00
CLS0236MO	Mouse Glutathione peroxidase(GPX)ELISA Kit	96 Test	38220090	24,500.00
CLS0237MO	Mouse Complement Factor I (CFI)ELISA Kit	96 Test	38220090	24,500.00
CLS0238MO	Mouse Epinephrine/Adrenaline,EPI ELISA Kit	96 Test	38220090	24,500.00
CLS0239MO	Mouse Noradrenaline,NE ELISA Kit	96 Test	38220090	24,500.00
CLS0240MO	Mouse Homovanillic acid,HVA ELISA Kit	96 Test	38220090	24,500.00
CLS0241MO	Mouse Epidermal growth factor receptor 2,HER2 ELISA Kit	96 Test	38220090	24,500.00
CLS0242MO	Mouse epidermal growth factor receptor,EGFR ELISA Kit	96 Test	38220090	24,500.00
CLS0243MO	Mouse Estrogen Receptor(ER)ELISA Kit	96 Test	38220090	24,500.00
CLS0244MO	Mouse cardiac troponin I ,cTn- I ELISA Kit	96 Test	38220090	24,500.00
CLS0245MO	Mouse Macrophage Migration Inhibitory Factor,MIF ELISA	96 Test	38220090	24,500.00
CLS0246MO	Mouse Irisin(irisin)ELISA Kit	96 Test	38220090	24,500.00
CLS0247MO	Mouse Apoprotein B(APO-B)ELISA Kit	96 Test	38220090	24,500.00
CLS0248MO	Mouse Mast Cell Tryptase,MCT ELISA kit	96 Test	38220090	24,500.00
CLS0249MO	Mouse S100 calcium binding protein A12(S100A12)ELISA Kit	96 Test	38220090	24,500.00
CLS0250MO	Mouse S100 calcium binding protein A7(S100A7)ELISA Kit	96 Test	38220090	24,500.00
CLS0251MO	Mouse S100 calcium binding protein A9/calgranulin B,S100A9 ELISA Kit	96 Test	38220090	24,500.00
CLS0252MO	Mouse S100 calcium binding protein A8/calgranulin A,S100A8 ELISA Kit	96 Test	38220090	24,500.00
CLS0253MO	Mouse Defensin Beta 104A(DEFB 104A)ELISA Kit	96 Test	38220090	24,500.00
CLS0254MO	Mouse Defensin Beta 103A(DEFB 103A)ELISA Kit	96 Test	38220090	24,500.00
CLS0255MO	Mouse Ubiquitin,Ub ELISA Kit	96 Test	38220090	24,500.00
CLS0256MO	Mouse Myonectin(CTRP15)ELISA Kit	96 Test	38220090	24,500.00
CLS0257MO	Mouse Thromboxane A2,TX-A2 ELISA Kit	96 Test	38220090	24,500.00
CLS0258MO	Mouse Coagulation Factor XII(F12)ELISA Kit	96 Test	38220090	24,500.00
CLS0259MO	Mouse Coagulation Factor VII(F7)ELISA Kit	96 Test	38220090	24,500.00
CLS0260MO	Mouse Aminomethyltransferase(AMT)ELISA Kit	96 Test	38220090	24,500.00
CLS0261MO	Mouse Hepcidin,Hepc ELISA Kit	96 Test	38220090	24,500.00
CLS0262MO	Mouse Interleukin 15,IL-15 ELISA Kit	96 Test	38220090	24,500.00
CLS0263MO	Mouse uncoupling protein 3, UCP3 ELISA Kit	96 Test	38220090	24,500.00
CLS0264MO	Mouse Osteoprotegerin,OPG ELISA KIT	96 Test	38220090	24,500.00
CLS0265MO	Mouse Nerve growth factor,NGF ELISA kit	96 Test	38220090	24,500.00
CLS0266MO	Mouse basic fibroblast growth factor,bFGF ELISA Kit	96 Test	38220090	24,500.00
CLS0267MO	Mouse hepatocyte growth factor,HGF ELISA kit	96 Test	38220090	24,500.00
CLS0268MO	Mouse Epidermal growth factor,EGF ELISA Kit	96 Test	38220090	24,500.00
CLS0269MO	Mouse anti-double stranded DNA IgG(dsDNA IgG)ELISA Kit	96 Test	38220090	24,500.00
CLS0270MO	Mouse anti-double stranded DNA,dsDNA ELISA KIT	96 Test	38220090	24,500.00
CLS0271MO	Mouse Total 50% Complement Hemolytic unit(CH50)ELISA Kit	96 Test	38220090	24,500.00
CLS0272MO	Mouse Glucagon-like peptide 2(GLP-2)ELISA Kit	96 Test	38220090	24,500.00
CLS0273MO	Mouse Triglyceride,TG ELISA Kit	96 Test	38220090	24,500.00
CLS0274MO	Mouse cholesterol,CH ELISA Kit	96 Test	38220090	24,500.00
CLS0275MO	Mouse Free Prostate Specific Antigen,fPSA ELISA Kit	96 Test	38220090	24,500.00
CLS0276MO	Mouse non-ester fatty acid(NEFA)ELISA Kit	96 Test	38220090	24,500.00
CLS0277MO	Mouse Transforming Growth factor β 1,TGF- β 1 ELISA kit	96 Test	38220090	24,500.00
CLS0278MO	Mouse Interleukin 13,IL-13 ELISA Kit	96 Test	38220090	24,500.00
CLS0279MO	Mouse Interleukin 5,IL-5 ELISA KIT	96 Test	38220090	24,500.00
CLS0280MO	Mouse Angiopoietin 1,ANG-1 ELISA Kit	96 Test	38220090	24,500.00

Cat.No.	Product Description	Pack Size	HSN	Unit Price
CLS0281MO	Mouse inducible nitric oxide synthase,iNOS ELISA KIT	96 Test	38220090	24,500.00
CLS0282MO	Mouse Interferon α ,IFN- α ELISA Kit	96 Test	38220090	24,500.00
CLS0283MO	Mouse Lymphotoxin-beta,LTB ELISA Kit	96 Test	38220090	24,500.00
CLS0284MO	Mouse Lymphotoxin-alpha,LTA ELISA Kit	96 Test	38220090	24,500.00
CLS0285MO	Mouse spleen tyrosine kinase(Syk)ELISA Kit	96 Test	38220090	24,500.00
CLS0286MO	Mouse β -Thromboglobulin, β -TG ELISA Kit	96 Test	38220090	24,500.00
CLS0287MO	Mouse Acid Phosphatase 1,ACP1 ELISA Kit	96 Test	38220090	24,500.00
CLS0288MO	Mouse visfatin ELISA Kit	96 Test	38220090	24,500.00
CLS0289MO	Mouse Vascuolar endothelial cell growth factor receptor 3(VEGFR-3/Flt-4)ELISA Kit	96 Test	38220090	24,500.00
CLS0290MO	Mouse Tumor Protein, Translationally Controlled 1 (TPT1)ELISA Kit	96 Test	38220090	24,500.00
CLS0291MO	Mouse ultrasensitive thyroid-stimulating hormone(U-TSH)ELISA Kit	96 Test	38220090	24,500.00
CLS0292MO	Mouse Troponin T,Tn-T ELISA Kit	96 Test	38220090	24,500.00
CLS0293MO	Mouse Tumor necrosis factor soluble receptor I ,TNFsR-I ELISA KIT	96 Test	38220090	24,500.00
CLS0294MO	Mouse Thyroglobulin,TG ELISA Kit	96 Test	38220090	24,500.00
CLS0295MO	Mouse tissue inhibitors of metalloproteinase 1,TIMP-1 ELISA Kit	96 Test	38220090	24,500.00
CLS0296MO	Mouse pulmonary activation regulated chemokine,PARC/CCL18 ELISA Kit	96 Test	38220090	24,500.00
CLS0297MO	Mouse rheumatoid factor,RF ELISA Kit	96 Test	38220090	24,500.00
CLS0298MO	Mouse Soluble Endoglin,ENG/sCD105 ELISA Kit	96 Test	38220090	24,500.00
CLS0299MO	Mouse soluble interleukin-2 receptor,IL-2sR α ELISA kit	96 Test	38220090	24,500.00
CLS0300MO	Mouse pigment epithelium-derived factor,PEDF ELISA Kit	96 Test	38220090	24,500.00
CLS0301MO	Mouse Platelet-Derived Growth Factor-B,PDGF-B ELISA kit	96 Test	38220090	24,500.00
CLS0302MO	Mouse Protein lin-28 homolog B(LIN28B) ELISA Kit	96 Test	38220090	24,500.00
CLS0303MO	Mouse Perforin/Pore-forming protein,PF/PFP ELISA Kit	96 Test	38220090	24,500.00
CLS0304MO	Mouse Phospholipase C,PLC ELISA Kit	96 Test	38220090	24,500.00
CLS0305MO	Mouse Neuron-specific enolase,NSE ELISA Kit	96 Test	38220090	24,500.00
CLS0306MO	Mouse N-terminal procollagen III propeptide,P III NP ELISA Kit	96 Test	38220090	24,500.00
CLS0307MO	Mouse Oncostatin-M,OSM ELISA KIT	96 Test	38220090	24,500.00
CLS0308MO	Mouse N-terminal pro-brain natriuretic peptide,NT-proBNP ELISA KIT	96 Test	38220090	24,500.00
CLS0309MO	Mouse nitric oxide synthase,NOS ELISA Kit	96 Test	38220090	24,500.00
CLS0310MO	Mouse Orexin A ELISA Kit	96 Test	38220090	24,500.00
CLS0311MO	Mouse phospho Protein Kinase C,P-PKC ELISA Kit	96 Test	38220090	24,500.00
CLS0312MO	Mouse Melatonin,MT ELISA Kit	96 Test	38220090	24,500.00
CLS0313MO	Mouse Mucin-5 subtype AC,MUC5AC ELISA Kit	96 Test	38220090	24,500.00
CLS0314MO	Mouse myeloperoxidase,MPO ELISA Kit	96 Test	38220090	24,500.00
CLS0315MO	Mouse nicotinamide adenine dinucleotide phosphate,NADPH ELISA Kit	96 Test	38220090	24,500.00
CLS0316MO	Mouse Matrix metalloproteinase 2/Gelatinase A(MMP-2/Gelatinase A)ELISA Kit	96 Test	38220090	24,500.00
CLS0317MO	Mouse matrix metalloproteinase 9//Gelatinase B,MMP-9 ELISA Kit	96 Test	38220090	24,500.00
CLS0318MO	Mouse low density lipoprotein,LDL ELISA Kit	96 Test	38220090	24,500.00
CLS0319MO	Mouse malondialdehyde,MDA ELISA Kit	96 Test	38220090	24,500.00
CLS0320MO	Mouse Interleukin 2,IL-2 ELISA kit	96 Test	38220090	24,500.00
CLS0321MO	Mouse Interleukin 17,IL-17 ELISA Kit	96 Test	38220090	24,500.00
CLS0322MO	Mouse Insulin-like growth factor 1,IGF-1 ELISA Kit	96 Test	38220090	24,500.00
CLS0323MO	Mouse indoleamine 2,3-dioxygenase,IDO ELISA Kit	96 Test	38220090	24,500.00
CLS0324MO	Mouse Insulin Like Growth Factor Binding Protein 1 (IGFBP1)ELISA Kit	96 Test	38220090	24,500.00
CLS0325MO	Mouse Hyaluronic acid,HA ELISA Kit	96 Test	38220090	24,500.00
CLS0326MO	Mouse Immunoglobulin E,IgE ELISA Kit	96 Test	38220090	24,500.00

Cat.No.	Product Description	Pack Size	HSN	Unit Price
CLS0327MO	Mouse Heparanase,HPA ELISA kit	96 Test	38220090	24,500.00
CLS0328MO	Mouse hepatitis B virus surface antibody(HBSAB)ELISA Kit	96 Test	38220090	24,500.00
CLS0329MO	Mouse High density lipoprotein,HDL ELISA Kit	96 Test	38220090	24,500.00
CLS0330MO	Mouse Glucose-6-phosphate 1-dehydrogenase(G6PD)ELISA kit	96 Test	38220090	24,500.00
CLS0331MO	Mouse gonadotropin-releasing hormone,GnRH ELISA Kit	96 Test	38220090	24,500.00
CLS0332MO	Mouse Estriol,E3 ELISA Kit	96 Test	38220090	24,500.00
CLS0333MO	Mouse gamma glutamyl transpeptidase,GGT ELISA Kit	96 Test	38220090	24,500.00
CLS0334MO	Mouse Estradiol,E2 ELISA Kit	96 Test	38220090	24,500.00
CLS0335MO	Mouse cyclooxygenase-2,COX-2 ELISA Kit	96 Test	38220090	24,500.00
CLS0336MO	Mouse Dehydroepiandrosterone,DHEA ELISA Kit	96 Test	38220090	24,500.00
CLS0337MO	Mouse Creatine Transporter (CRT)ELISA kit	96 Test	38220090	24,500.00
CLS0338MO	Mouse Cyclic guanosine monophosphate,cGMP ELISA Kit	96 Test	38220090	24,500.00
CLS0339MO	Mouse ovalbumin specific IgG,OVA sIgG ELISA Kit	96 Test	38220090	24,500.00
CLS0340MO	Mouse ovalbumin specific IgG1,OVA sIgG1 ELISA Kit	96 Test	38220090	24,500.00
CLS0341MO	Mouse Catalase (CAT)ELISA Kit	96 Test	38220090	24,500.00
CLS0342MO	Mouse Corticosterone,CORT ELISA Kit	96 Test	38220090	24,500.00
CLS0343MO	Mouse C-telopeptide of type I collagen,CTX- I ELISA Kit	96 Test	38220090	24,500.00
CLS0344MO	Mouse Collagen Type I ,Col I ELISA Kit	96 Test	38220090	24,500.00
CLS0345MO	Mouse Collagen Type II ,Col II ELISA Kit	96 Test	38220090	24,500.00
CLS0346MO	Mouse Collagen Type IV,Col IV ELISA KIT	96 Test	38220090	24,500.00
CLS0347MO	Mouse Beta-Endorphin, β -EP ELISA Kit	96 Test	38220090	24,500.00
CLS0348MO	Mouse C-Peptide ELISA Kit	96 Test	38220090	24,500.00
CLS0349MO	Mouse α 1-Antitrypsin, α 1-AT ELISA Kit	96 Test	38220090	24,500.00
CLS0350MO	Mouse Anti-Thrombin III ,AT- III ELISA Kit	96 Test	38220090	24,500.00
CLS0351MO	Mouse apoprotein,apo-A1 ELISA Kit	96 Test	38220090	24,500.00
CLS0352MO	Mouse Aspartate aminotransferase,AST ELISA Kit	96 Test	38220090	24,500.00
CLS0353MO	Mouse Soluble Vascular Endothelial Growth Factor Receptor 2(VEGFR-2/sFLK-1)ELISA kit	96 Test	38220090	24,500.00
CLS0354MO	Mouse α -glutathione S-transferases, α -GST ELISA Kit	96 Test	38220090	24,500.00
CLS0355MO	Mouse Anti-Mullerian Hormone(AMH)ELISA Kit	96 Test	38220090	24,500.00
CLS0356MO	Mouse Uromodulin(UMOD)ELISA Kit	96 Test	38220090	24,500.00
CLS0357MO	Mouse v-rel avian reticuloendotheliosis viral oncogene related B,RELB ELISA Kit	96 Test	38220090	24,500.00
CLS0358MO	Mouse 5-hydroxyindoleacetic acid,5-HIAA ELISA Kit	96 Test	38220090	24,500.00
CLS0359MO	Mouse advanced glycation end products,AGEs ELISA Kit	96 Test	38220090	24,500.00
CLS0360MO	Mouse Ubiquitin Carboxyl Terminal Hydrolase L1 (UCHL1)ELISA Kit	96 Test	38220090	24,500.00
CLS0361MO	Mouse Troponin T Type 2, Cardiac (TNNT2)ELISA kit	96 Test	38220090	24,500.00
CLS0362MO	Mouse trypsinogen activation peptide,TAP ELISA Kit	96 Test	38220090	24,500.00
CLS0363MO	Mouse Tumor necrosis factor receptor superfamily member 4,Tnfrsf4/Ox40 ELISA Kit	96 Test	38220090	24,500.00
CLS0364MO	Mouse transforming growth factor α ,TGF- α ELISA Kit	96 Test	38220090	24,500.00
CLS0365MO	Mouse Transthyretin,TTR ELISA Kit	96 Test	38220090	24,500.00
CLS0366MO	Mouse Thyroid Stimulating Hormone,TSH ELISA Kit	96 Test	38220090	24,500.00
CLS0367MO	Mouse thyrotropin-releasing hormone,TRH ELISA KIT	96 Test	38220090	24,500.00
CLS0368MO	Mouse inhibitory subunit of NF- κ B α ,IKB α ELISA Kit	96 Test	38220090	24,500.00
CLS0369MO	Mouse inositol 1,4,5,-trisphosphate,IP3 ELISA kit	96 Test	38220090	24,500.00
CLS0370MO	Mouse Inhibin,INH-A ELISA Kit	96 Test	38220090	24,500.00
CLS0371MO	Mouse Immunoglobulin,IgA ELISA Kit	96 Test	38220090	24,500.00
CLS0372MO	Mouse hypoxia-inducible factor 1 α ,HIF-1 α ELISA Kit	96 Test	38220090	24,500.00
CLS0373MO	Mouse Histidine-proline-rich glycoprotein(HPRG) ELISA Kit	96 Test	38220090	24,500.00
CLS0374MO	Mouse Hormone sensitive lipase(HSL)ELISA Kit	96 Test	38220090	24,500.00
CLS0375MO	Mouse Heat Shock Protein 90kDa Alpha A1 (HSP90aA1)ELISA kit	96 Test	38220090	24,500.00
CLS0376MO	Mouse High density lipoprotein cholesterol(HDL-C)ELISA Kit	96 Test	38220090	24,500.00

Cat.No.	Product Description	Pack Size	HSN	Unit Price
CLS0377MO	Mouse High mobility group protein B1, HMGB-1 ELISA Kit	96 Test	38220090	24,500.00
CLS0378MO	Mouse growth differentiation factor 15, GDF15 ELISA Kit	96 Test	38220090	24,500.00
CLS0379MO	Mouse Growth Differentiation Factor3(GDF3)ELISA Kit	96 Test	38220090	24,500.00
CLS0380MO	Mouse Haptoglobin, Hpt/HP ELISA KIT	96 Test	38220090	24,500.00
CLS0381MO	Mouse granulysin, GNLY ELISA Kit	96 Test	38220090	24,500.00
CLS0382MO	Mouse Glucagon-like peptide 1, GLP-1 ELISA Kit	96 Test	38220090	24,500.00
CLS0383MO	Mouse Glutamate oxaloacetate transaminase 1, GOT1 ELISA Kit	96 Test	38220090	24,500.00
CLS0384MO	Mouse Glutathione reductase(GR) ELISA kit	96 Test	38220090	24,500.00
CLS0385MO	Mouse Gastrokine 1 (GKN1)ELISA kit	96 Test	38220090	24,500.00
CLS0386MO	Mouse Glucagon, GC ELISA Kit	96 Test	38220090	24,500.00
CLS0387MO	Mouse free fatty acids, FFA ELISA Kit	96 Test	38220090	24,500.00
CLS0388MO	Mouse Free Thyroxine, FT4 ELISA Kit	96 Test	38220090	24,500.00
CLS0389MO	Mouse Free Tri-iodothyronine Indes, Free-T3 ELISA Kit	96 Test	38220090	24,500.00
CLS0390MO	Mouse fibroblast growth factor-23, FGF-23 ELISA Kit	96 Test	38220090	24,500.00
CLS0391MO	Mouse forkhead box P3, Foxp3 ELISA Kit	96 Test	38220090	24,500.00
CLS0392MO	Mouse Fetuin A, FETU-A ELISA Kit	96 Test	38220090	24,500.00
CLS0393MO	Mouse fibrinopeptide A, FPA ELISA Kit	96 Test	38220090	24,500.00
CLS0394MO	Mouse Fibroblast Growth Factor 1, Acidic (FGF1)ELISA kit	96 Test	38220090	24,500.00
CLS0395MO	Mouse Factor-related Apoptosis ligand, FASL ELISA Kit	96 Test	38220090	24,500.00
CLS0396MO	Mouse fatty acid binding protein, FABP4 ELISA Kit	96 Test	38220090	24,500.00
CLS0397MO	Mouse eosinophil cationic protein, ECP ELISA Kit	96 Test	38220090	24,500.00
CLS0398MO	Mouse Eotaxin 1 (CCL11) ELISA Kit	96 Test	38220090	24,500.00
CLS0399MO	Mouse E3/ubiquitin-protein ligase, E3/UBPL ELISA Kit	96 Test	38220090	24,500.00
CLS0400MO	Mouse Endostatin, ES ELISA Kit	96 Test	38220090	24,500.00
CLS0401MO	Mouse DNA (cytosine-5)-methyltransferase 3B (DNMT3B) ELISA Kit	96 Test	38220090	24,500.00
CLS0402MO	Mouse DNA methyltransferase 1, DNAM1 ELISA Kit	96 Test	38220090	24,500.00
CLS0403MO	Mouse E1/ubiquitin-activating enzyme, E1/UBAE ELISA Kit	96 Test	38220090	24,500.00
CLS0404MO	Mouse E2/ubiquitin-conjugating enzyme, E2/UBCE ELISA Kit	96 Test	38220090	24,500.00
CLS0405MO	Mouse Dickkopf-3, DKK3 ELISA Kit	96 Test	38220090	24,500.00
CLS0406MO	Mouse Dihydrotestosterone, DHT ELISA Kit	96 Test	38220090	24,500.00
CLS0407MO	Mouse DNA (cytosine-5)-methyltransferase 3A (DNMT3A) ELISA Kit	96 Test	38220090	24,500.00
CLS0408MO	Mouse deubiquitinating enzyme, DUB ELISA Kit	96 Test	38220090	24,500.00
CLS0409MO	Mouse diamine oxidase, DAO ELISA Kit	96 Test	38220090	24,500.00
CLS0410MO	Mouse Dickkopf Related Protein 2 (DKK2)ELISA Kit	96 Test	38220090	24,500.00
CLS0411MO	Mouse Procalcitonin, PCT ELISA Kit	96 Test	38220090	24,500.00
CLS0412MO	Mouse Renin ELISA Kit	96 Test	38220090	24,500.00
CLS0413MO	Mouse Secreted Frizzled Related Protein 5 (SFRP5)ELISA Kit	96 Test	38220090	24,500.00
CLS0414MO	Mouse soluble receptor activator of nuclear factor-kB ligand(sRANKL)ELISA Kit	96 Test	38220090	24,500.00
CLS0415MO	Mouse Somatostatin, SS ELISA Kit	96 Test	38220090	24,500.00
CLS0416MO	Mouse thrombin-antithrombin complex, TAT ELISA Kit	96 Test	38220090	24,500.00
CLS0417MO	Mouse thyroxine, T4 ELISA Kit	96 Test	38220090	24,500.00
CLS0418MO	Mouse Total antioxidant capacity (T-AOC)ELISA Kit	96 Test	38220090	24,500.00
CLS0419MO	Mouse total cholesterol, TC ELISA Kit	96 Test	38220090	24,500.00
CLS0420MO	Mouse Tri-iodothyronine, T3 ELISA Kit	96 Test	38220090	24,500.00
CLS0421MO	Mouse α 1-Acid glycoprotein(α 1-AGP)ELISA Kit	96 Test	38220090	24,500.00
CLS0422MO	Mouse amyloid beta peptide 1-40, A β 1-40 ELISA Kit	96 Test	38220090	24,500.00
CLS0423MO	Mouse Angiopoietin 2, ANG-2 ELISA Kit	96 Test	38220090	24,500.00
CLS0424MO	Mouse Angiotensin I (Ang I)ELISA Kit	96 Test	38220090	24,500.00
CLS0425MO	Mouse antidiuretic hormone(ADH)ELISA Kit	96 Test	38220090	24,500.00
CLS0426MO	Mouse anti-diuretic hormone/vasopressin/arginine vasopressin, ADH/VP/AVP ELISA Kit	96 Test	38220090	24,500.00
CLS0427MO	Mouse anti-nucleolus antibody, ANA ELISA Kit	96 Test	38220090	24,500.00

Cat.No.	Product Description	Pack Size	HSN	Unit Price
CLS0428MO	Mouse anti-oligodendrocyte-myelin glycoprotein antibody,OMgp-Ab ELISA Kit	96 Test	38220090	24,500.00
CLS0429MO	Mouse Anti-trypsin,AT ELISA Kit	96 Test	38220090	24,500.00
CLS0430MO	Mouse Apelin ,AP ELISA Kit	96 Test	38220090	24,500.00
CLS0431MO	Mouse B-cell leukemia/lymphoma 2,Bcl-2 ELISA Kit	96 Test	38220090	24,500.00
CLS0432MO	Mouse Bcl-2 associated X protein(BAX)ELISA Kit	96 Test	38220090	24,500.00
CLS0433MO	Mouse bone alkaline phosphatase,BALP ELISA Kit	96 Test	38220090	24,500.00
CLS0434MO	Mouse Bone Morphogenetic Protein 3 (BMP3)ELISA kit	96 Test	38220090	24,500.00
CLS0435MO	Mouse bone sialoprotein,BSP ELISA Kit	96 Test	38220090	24,500.00
CLS0436MO	Mouse Calcitonin,CT ELISA Kit	96 Test	38220090	24,500.00
CLS0437MO	Mouse Carboxyterminal propeptide of type I procollagen,P I CP ELISA Kit	96 Test	38220090	24,500.00
CLS0438MO	Mouse c-fos ELISA Kit	96 Test	38220090	24,500.00
CLS0439MO	Mouse Clara cell protein,CC16 ELISA Kit	96 Test	38220090	24,500.00
CLS0440MO	Mouse Complement 4,C4 ELISA Kit	96 Test	38220090	24,500.00
CLS0441MO	Mouse Complement Factor H Related Protein 3 (CFHR3)ELISA Kit	96 Test	38220090	24,500.00
CLS0442MO	Mouse connective tissue growth factor,CTGF ELISA Kit	96 Test	38220090	24,500.00
CLS0443MO	Mouse corticotropin releasing hormone,CRH ELISA Kit	96 Test	38220090	24,500.00
CLS0444MO	Mouse Cytochrome P450 1A2 (CYP1A2)ELISA kit	96 Test	38220090	24,500.00
CLS0445MO	Mouse endotoxin,ET ELISA Kit	96 Test	38220090	24,500.00
CLS0446MO	Mouse Fcoagulation factor IX,FIX ELISA Kit	96 Test	38220090	24,500.00
CLS0447MO	Mouse fetal hemoglobin,HbF ELISA Kit	96 Test	38220090	24,500.00
CLS0448MO	Mouse Fibronectin,FN ELISA Kit	96 Test	38220090	24,500.00
CLS0449MO	Mouse Folic acid,FA ELISA Kit	96 Test	38220090	24,500.00
CLS0450MO	Mouse formylmethionine,fMet ELISA Kit	96 Test	38220090	24,500.00
CLS0451MO	Mouse Galectin 9C (GAL9C) ELISA kit	96 Test	38220090	24,500.00
CLS0452MO	Mouse Gastrin,GAS ELISA Kit	96 Test	38220090	24,500.00
CLS0453MO	Mouse glucocorticoid receptor- α ,GR- α ELISA Kit	96 Test	38220090	24,500.00
CLS0454MO	Mouse Glucose transporter 4,GLUT4 ELISA Kit	96 Test	38220090	24,500.00
CLS0455MO	Mouse Glycated hemoglobin A1c,GHbA1c ELISA Kit	96 Test	38220090	24,500.00
CLS0456MO	Mouse Granulocyte Colony Stimulating Factor,G-CSF ELISA Kit	96 Test	38220090	24,500.00
CLS0457MO	Mouse Immunoglobulin G-1(IgG-1)ELISA Kit	96 Test	38220090	24,500.00
CLS0458MO	Mouse Immunoglobulin G-2(IgG-2)ELISA Kit	96 Test	38220090	24,500.00
CLS0459MO	Mouse Insulin-like growth factor 2,IGF-2 ELISA Kit	96 Test	38220090	24,500.00
CLS0460MO	Mouse Interferon β ,IFN- β /IFNB ELISA Kit	96 Test	38220090	24,500.00
CLS0461MO	Mouse Interleukin 16,IL-16 ELISA KIT	96 Test	38220090	24,500.00
CLS0462MO	Mouse Interleukin 32,IL-32 ELISA Kit	96 Test	38220090	24,500.00
CLS0463MO	Mouse Interleukin 35,IL-35 ELISA Kit	96 Test	38220090	24,500.00
CLS0464MO	Mouse intestinal fatty acid binding protein,IFABP ELISA Kit	96 Test	38220090	24,500.00
CLS0465MO	Mouse Lactate Dehydrogenase,LDH ELISA Kit	96 Test	38220090	24,500.00
CLS0466MO	Mouse Lactoferrin,LTF/LF ELISA kit	96 Test	38220090	24,500.00
CLS0467MO	Mouse Macrophage Inflammatory Protein 1 α ,MIP-1 α ELISA kit	96 Test	38220090	24,500.00
CLS0468MO	Mouse Macrophage Inflammatory Protein 1 γ ,MIP-1 γ ELISA kit	96 Test	38220090	24,500.00
CLS0469MO	Mouse matrix metalloproteinase 10,MMP-10 ELISA kit	96 Test	38220090	24,500.00
CLS0470MO	Mouse matrix metalloproteinase 13,MMP-13 ELISA kit	96 Test	38220090	24,500.00
CLS0471MO	Mouse STEAP family member 4,Steap4 ELISA Kit	96 Test	38220090	24,500.00
CLS0472MO	Mouse Stromal cell derived factor 1a,SDF-1a ELISA kit	96 Test	38220090	24,500.00
CLS0473MO	Mouse thrombomodulin,TM ELISA Kit	96 Test	38220090	24,500.00
CLS0474MO	Mouse Thromboxane B2,TXB2 ELISA Kit	96 Test	38220090	24,500.00
CLS0475MO	Mouse Thymic stromal lymphopoietin,TSLP ELISA Kit	96 Test	38220090	24,500.00
CLS0476MO	Mouse p16 ELISA Kit	96 Test	38220090	24,500.00
CLS0477MO	Mouse Parathyroid hormone,PTH ELISA Kit	96 Test	38220090	24,500.00
CLS0478MO	Mouse PaMonkeyhyroid Hormone-Like Related Protein(PThrP)ELISA Kit	96 Test	38220090	24,500.00

Cat.No.	Product Description	Pack Size	HSN	Unit Price
CLS0479MO	Mouse Phosphotylinosital 3 kinase,PI3K ELISA Kit	96 Test	38220090	24,500.00
CLS0480MO	Mouse placenta growth factor,PLGF ELISA kit	96 Test	38220090	24,500.00
CLS0481MO	Mouse platelet activating factor,PAF ELISA KIT	96 Test	38220090	24,500.00
CLS0482MO	Mouse procollagen I N-terminal peptide,P I NP ELISA Kit	96 Test	38220090	24,500.00
CLS0483MO	Mouse procollagen III N-terminal peptide,P III NT ELISA Ki	96 Test	38220090	24,500.00
CLS0484MO	Mouse Proinsulin,PI ELISA Kit	96 Test	38220090	24,500.00
CLS0485MO	Mouse prolactin,PRL ELISA Kit	96 Test	38220090	24,500.00
CLS0486MO	Mouse prostate specific antigen,PSA ELISA Kit	96 Test	38220090	24,500.00
CLS0487MO	Mouse protein kinase B,PKB ELISA Kit	96 Test	38220090	24,500.00
CLS0488MO	Mouse Protein O-Glucosyltransferase 1 (POGLUT1)ELISA kit	96 Test	38220090	24,500.00
CLS0489MO	Mouse Pulmonary surfatcant-associated protein B,SP-B ELISA Kit	96 Test	38220090	24,500.00
CLS0490MO	Mouse Qa lymphocyte antigen 2 region,Qa-2 ELISA Kit	96 Test	38220090	24,500.00
CLS0491MO	Mouse Rheumatoid factor (RF) antibody (IgA) ELISA Kit	96 Test	38220090	24,500.00
CLS0492MO	Mouse Rheumatoid factor (RF) antibody (IgG) ELISA Kit	96 Test	38220090	24,500.00
CLS0493MO	Mouse Rheumatoid factor (RF) antibody (IgM) ELISA Kit	96 Test	38220090	24,500.00
CLS0494MO	Mouse Secreted Frizzled Related Protein 4 (SFRP4)ELISA Kit	96 Test	38220090	24,500.00
CLS0495MO	Mouse secretory immunoglobulin A,sIgA ELISA Kit	96 Test	38220090	24,500.00
CLS0496MO	Mouse Serotonin transporter,SERT ELISA Kit	96 Test	38220090	24,500.00
CLS0497MO	Mouse Serotonin,ST ELISA Kit	96 Test	38220090	24,500.00
CLS0498MO	Mouse Signal transducer and activator of transcription 1,STAT1 ELISA Kit	96 Test	38220090	24,500.00
CLS0499MO	Mouse Signal transducer and activator of transcription 6,STAT6 ELISA Kit	96 Test	38220090	24,500.00
CLS0500MO	Mouse soluble amyloid precursor protein beta(sAPPbeta)ELISA Kit	96 Test	38220090	24,500.00
CLS0501MO	Mouse soluble amyloid precursor protein alpha,sAPPalpha ELISA Kit	96 Test	38220090	24,500.00
CLS0502MO	Mouse soluble endothelium-selectin,sE-selectin ELISA Kit	96 Test	38220090	24,500.00
CLS0503MO	Mouse Soluble Intercellular Adhesion Molecule 1,sICAM-1 ELISA Kit	96 Test	38220090	24,500.00
CLS0504MO	Mouse soluble platelet-selectin,sP-selectin ELISA Kit	96 Test	38220090	24,500.00
CLS0505MO	Mouse soluble Vascular cell adhesion molecule 1,sVCAM-1	96 Test	38220090	24,500.00
CLS0506MO	Mouse Soluble Vascular Endothelial Growth Factor Receptor 1(sFlt-1/sVEGFR-1)ELISA kit	96 Test	38220090	24,500.00
CLS0507MO	Mouse nuclear factor-kB p65,NF-kB p65 ELISA Kit	96 Test	38220090	24,500.00
CLS0508MO	Mouse Nuclear receptor ROR-gamma(RORC) ELISA Kit	96 Test	38220090	24,500.00
CLS0509MO	Mouse ovalbumin specific IgE,OVA sIgE ELISA Kit	96 Test	38220090	24,500.00
CLS0510MO	Mouse oxidized glutathione,GSSG ELISA Kit	96 Test	38220090	24,500.00
CLS0511MO	Mouse oxytocin,OT ELISA Kit	96 Test	38220090	24,500.00
CLS0512MO	Mouse Low density lipoprotein cholesterol(LDL-C)ELISA Kit	96 Test	38220090	24,500.00
CLS0513MO	Mouse Low Density Lipoprotein Receptor (LDLR)ELISA kit	96 Test	38220090	24,500.00
CLS0514MO	Mouse Lysozyme,LZM ELISA Kit	96 Test	38220090	24,500.00
CLS0515MO	Mouse matrix metalloproteinase 3,MMP-3 ELISA kit	96 Test	38220090	24,500.00
CLS0516MO	Mouse Methemoglobin,MHB ELISA Kit	96 Test	38220090	24,500.00
CLS0517MO	Mouse Microalbuminuria,MAU/ALB ELISA Kit	96 Test	38220090	24,500.00
CLS0518MO	Mouse N-acetyl-beta-D-glucosaminidase,NAG ELISA Kit	96 Test	38220090	24,500.00
CLS0519MO	Mouse Neuregulin 1,NRG-1 ELISA Kit	96 Test	38220090	24,500.00
CLS0520MO	Mouse neutrophil activating protein-2,NAP-2 ELISA Kit	96 Test	38220090	24,500.00
CLS0521MO	Mouse Intelectin-1,ITLN1/Omentin ELISA Kit	96 Test	38220090	24,500.00
CLS0522MO	Mouse Interleukin 6 receptor,IL6R ELISA Kit	96 Test	38220090	24,500.00
CLS0523MO	Mouse Interleukin 17A,IL-17A ELISA Kit	96 Test	38220090	24,500.00
CLS0524MO	Mouse Interleukin 17F,IL-17F ELISA Kit	96 Test	38220090	24,500.00

Cat.No.	Product Description	Pack Size	HSN	Unit Price
CLS0525MO	Mouse Kallikrein 6, KLK6 ELISA Kit	96 Test	38220090	24,500.00
CLS0526MO	Mouse Kisspeptin 1(KISS-1) ELISA Kit	96 Test	38220090	24,500.00
CLS0527MO	Mouse Laminin, LN ELISA kit	96 Test	38220090	24,500.00
CLS0528MO	Mouse latent transforming growth factor beta binding protein 2, LTBP2 ELISA Kit	96 Test	38220090	24,500.00
CLS0529MO	Mouse Leptin Soluble Receptor, sLR ELISA Kit	96 Test	38220090	24,500.00
CLS0530MO	Mouse Leukotriene B4, LT-B4 ELISA Kit	96 Test	38220090	24,500.00
CLS0531MO	Mouse lipid peroxide(LPO)ELISA Kit	96 Test	38220090	24,500.00
CLS0532MO	Mouse Lipoprotein Associated Phospholipase A2(LP-PLA2)ELISA Kit	96 Test	38220090	24,500.00
CLS0533MO	Mouse cyclic adenosine monophosphate, cAMP ELISA Kit	96 Test	38220090	24,500.00
CLS0534MO	Mouse CYR61 Cysteine-rich protein 61, Cyr 61 ELISA Kit	96 Test	38220090	24,500.00
CLS0535MO	Mouse D-Dimer(D2D)ELISA Kit	96 Test	38220090	24,500.00
CLS0536MO	Mouse Dehydroepiandrosterone sulfate, DHEA-S ELISA Kit	96 Test	38220090	24,500.00
CLS0537MO	Mouse Delta Like Protein 4 (DLL4)ELISA Kit	96 Test	38220090	24,500.00
CLS0538MO	Mouse coagulation factor VIII related antigen, FVIII-Ag ELISA KIT	96 Test	38220090	24,500.00
CLS0539MO	Mouse coagulation factor Xa, FXa ELISA kit	96 Test	38220090	24,500.00
CLS0540MO	Mouse Coiled Coil Domain Containing Protein 3 (CCDC3)ELISA Kit	96 Test	38220090	24,500.00
CLS0541MO	Mouse Complement 3, C3 ELISA Kit	96 Test	38220090	24,500.00
CLS0542MO	Mouse complement factor H, CFH ELISA Kit	96 Test	38220090	24,500.00
CLS0543MO	Mouse Complement fragment 5a, C5a ELISA Kit	96 Test	38220090	24,500.00
CLS0544MO	Mouse Creatine Kinase MB isoenzyme, CK-MB ELISA Kit	96 Test	38220090	24,500.00
CLS0545MO	Mouse Creatinine, Cr ELISA Kit	96 Test	38220090	24,500.00
CLS0546MO	Mouse cross linked C-telopeptide of type I collagen, CTX-I ELISA Kit	96 Test	38220090	24,500.00
CLS0547MO	Mouse brain natriuretic peptide, BNP ELISA Kit	96 Test	38220090	24,500.00
CLS0548MO	Mouse Caspase 1 (CASP1)ELISA kit	96 Test	38220090	24,500.00
CLS0549MO	Mouse cathepsin D, cath-D ELISA Kit	96 Test	38220090	24,500.00
CLS0550MO	Mouse Cathepsin L(Cath-L)ELISA Kit	96 Test	38220090	24,500.00
CLS0551MO	Mouse Chitinase-3-like Protein 1(YKL-40/CHI3L1)ELISA Kit	96 Test	38220090	24,500.00
CLS0552MO	Mouse cholecystokinin octapeptide, CCK-8 ELISA Kit	96 Test	38220090	24,500.00
CLS0553MO	Mouse C-telopeptide of type II collagen, CTX-II ELISA Kit	96 Test	38220090	24,500.00
CLS0554MO	Mouse C-type natriuretic peptide, CNP ELISA Kit	96 Test	38220090	24,500.00
CLS0555MO	Mouse aldehyde dehydrogenase 2, ALDH2 ELISA kit	96 Test	38220090	24,500.00
CLS0556MO	Mouse Alpha-fetoprotein, AFP ELISA Kit	96 Test	38220090	24,500.00
CLS0557MO	Mouse α-L-iduronidase, IDUA ELISA Kit	96 Test	38220090	24,500.00
CLS0558MO	Mouse Angiotensin Like Protein 6 (ANGPTL6)ELISA kit	96 Test	38220090	24,500.00
CLS0559MO	Mouse Angiotensin-like protein 3, ANGPTL3 ELISA Kit	96 Test	38220090	24,500.00
CLS0560MO	Mouse Angiotensin-like protein 4, ANGPTL4 ELISA Kit	96 Test	38220090	24,500.00
CLS0561MO	Mouse Angiotensin converting enzyme 2, ACE2 ELISA Kit	96 Test	38220090	24,500.00
CLS0562MO	Mouse Apolipoprotein E, Apo-E ELISA Kit	96 Test	38220090	24,500.00
CLS0563MO	Mouse apoprotein B100, apo-B100 ELISA Kit	96 Test	38220090	24,500.00
CLS0564MO	Mouse Aquaporin 4, AQP-4 ELISA Kit	96 Test	38220090	24,500.00
CLS0565MO	Mouse arginine, Arg ELISA Ki	96 Test	38220090	24,500.00
CLS0566MO	Mouse Atrial natriuretic peptide receptor 3, NPR3 ELISA kit	96 Test	38220090	24,500.00
CLS0567MO	Mouse beta-catenin(beta-cat)ELISA Kit	96 Test	38220090	24,500.00
CLS0568MO	Mouse Beta-Hydroxybutyric Acid, β-OHB ELISA Kit	96 Test	38220090	24,500.00
CLS0569MO	Mouse Biopyrrin(BPn)ELISA Kit	96 Test	38220090	24,500.00
CLS0570MO	Mouse Bone morphogenetic protein 4(BMP-4)ELISA Kit	96 Test	38220090	24,500.00
CLS0571MO	Mouse Bone Morphogenetic Protein 6 (BMP6)ELISA kit	96 Test	38220090	24,500.00
CLS0572MO	Mouse 1,25-dihydroxyvitamin D3, DVD/DHVD3 ELISA Kit	96 Test	38220090	24,500.00
CLS0573MO	Mouse 4-Hydroxynonenal, 4HNE ELISA Kit	96 Test	38220090	24,500.00
CLS0574MO	Mouse acetylcholine receptor antibody, AChRab ELISA Kit	96 Test	38220090	24,500.00

Cat.No.	Product Description	Pack Size	HSN	Unit Price
CLS0575MO	Mouse Activin A (ACV-A)ELISA kit	96 Test	38220090	24,500.00
CLS0576MO	Mouse Acylated ghrelin(AG) ELISA kit	96 Test	38220090	24,500.00
CLS0577MO	Mouse albumin(ALB)ELISA Kit	96 Test	38220090	24,500.00
CLS0578MO	Mouse Bcl-2 associated X protein(BAX)ELISA Kit	96 Test	38220090	24,500.00
CLS0579MO	Mouse cyclophilin A,CyPA ELISA Kit	96 Test	38220090	24,500.00
CLS0580MO	Mouse Interferon gamma(IFN-gamma)ELISA Kit	96 Test	38220090	24,500.00
CLS0581MO	Mouse Follistatin,FS ELISA Kit	96 Test	38220090	24,500.00
CLS0582MO	Mouse Defensin Beta 14 (DEFb14)ELISA Kit	96 Test	38220090	24,500.00
CLS0583MO	Mouse Alpha-1-Acid Glycoprotein (a1AGP/ORM1)ELISA kit	96 Test	38220090	24,500.00
CLS0584MO	Mouse Mothers against decapentaplegic homolog 7,Smad7 ELISA Kit	96 Test	38220090	24,500.00
CLS0585MO	Mouse Substance P,SP ELISA Kit	96 Test	38220090	24,500.00
CLS0586MO	Mouse Tenascin M3 (TENM3)ELISA Kit	96 Test	38220090	24,500.00
CLS0587MO	Mouse Methionyl Aminopeptidase 2 (METAP2)ELISA Kit	96 Test	38220090	24,500.00
CLS0588MO	Mouse Selenide, water dikinase 1,SEPHS1 ELISA kit	96 Test	38220090	24,500.00
CLS0589MO	Mouse leukocyte immunoglobulin-like receptor subfamily B member 4,LILRB4 ELISA Kit	96 Test	38220090	24,500.00
CLS0590MO	Mouse Macrophage Colony-Stimulating Factor Receptor,M-CSFR/CD115 ELISA Kit	96 Test	38220090	24,500.00
CLS0591MO	Mouse insulin-like growth factors 2 receptor,IGF-2R ELISA Kit	96 Test	38220090	24,500.00
CLS0592MO	Mouse Receptor II for the Fc region of immunoglobulin E,FcεR II ELISA Kit	96 Test	38220090	24,500.00
CLS0593MO	Mouse lymphocyte function associated antigen 3,(LFA-3/CD58)ELISA Kit	96 Test	38220090	24,500.00
CLS0594MO	Mouse apelin 12,AP12 ELISA Kit	96 Test	38220090	24,500.00
CLS0595MO	Mouse Macrophage-Derived Chemokine,MDC ELISA kit	96 Test	38220090	24,500.00
CLS0596MO	Mouse Podoplanin (PDPN)ELISA kit	96 Test	38220090	24,500.00
CLS0597MO	Mouse glial cell line-derived neurotrophic factor,GDNF ELISA kit	96 Test	38220090	24,500.00
CLS0598MO	Mouse CXC-chemokine receptor 1,CXCR1/IL8Ra ELISA Kit	96 Test	38220090	24,500.00
CLS0599MO	Mouse secondary lymphoid-tissue chemokine,SLC ELISA Kit	96 Test	38220090	24,500.00
CLS0600MO	Mouse sex hormone-binding globulin,SHBG ELISA Kit	96 Test	38220090	24,500.00
CLS0601MO	Mouse Osteopontin,OPN ELISA Kit	96 Test	38220090	24,500.00
CLS0602MO	Mouse Alanine Aminotransferase(ALT)ELISA Kit	96 Test	38220090	24,500.00
CLS0603MO	Mouse Factor-related Apoptosis,FAS ELISA Kit	96 Test	38220090	24,500.00
CLS0604MO	Mouse endothelium Selectin,E-Selectin ELISA kit	96 Test	38220090	24,500.00
CLS0605MO	Mouse Erythropoietin,EPO ELISA Kit	96 Test	38220090	24,500.00
CLS0606MO	Mouse eosinophil chemotactic factor,ECF ELISA Kit	96 Test	38220090	24,500.00
CLS0607MO	Mouse soluble endothelial protein C receptor,sEPCR ELISA Kit	96 Test	38220090	24,500.00
CLS0608MO	Mouse Cluster of differentiation 30,CD30 ELISA Kit	96 Test	38220090	24,500.00
CLS0609MO	Mouse Bone morphogenetic protein receptor II ,BMPR-II ELISA Kit	96 Test	38220090	24,500.00
CLS0610MO	Mouse Bone morphogenetic protein receptor 1A,BMPR-1A ELISA Kit	96 Test	38220090	24,500.00
CLS0611MO	Mouse Bone morphogenetic protein 2,BMP-2 ELISA Kit	96 Test	38220090	24,500.00
CLS0612MO	Mouse keratinocyte autocrine KXctor/Amphiregulin,KAF/AR ELISA KIT	96 Test	38220090	24,500.00
CLS0613MO	Mouse Angiotensin converting enzyme,ACE ELISA Kit	96 Test	38220090	24,500.00
CLS0614MO	Mouse Interleukin 11,IL-11 ELISA KIT	96 Test	38220090	24,500.00
CLS0615MO	Mouse α-galactoyl,Gal ELISA Kit	96 Test	38220090	24,500.00
CLS0616MO	Mouse α-Hydroxybutyrate Dehydrogenase,αHBDH ELISA Kit	96 Test	38220090	24,500.00
CLS0617MO	Mouse α mannosidase,α Manase ELISA Kit	96 Test	38220090	24,500.00
CLS0618MO	Mouse αN-acetylglucosaminidase,αNAG ELISA Kit	96 Test	38220090	24,500.00
CLS0619MO	Mouse bradykinin,BK ELISA Kit	96 Test	38220090	24,500.00

Cat.No.	Product Description	Pack Size	HSN	Unit Price
CLS0620MO	Mouse Big Endothelin,Big ET ELISA Kit	96 Test	38220090	24,500.00
CLS0621MO	Mouse glucoprotein 130,gp130/CD130 ELISA KIT	96 Test	38220090	24,500.00
CLS0622MO	Mouse Stromal cell derived factor 1 β ,SDF-1 β ELISA kit	96 Test	38220090	24,500.00
CLS0623MO	Mouse 17-Hydroxycorticosteroids,17-OHCS ELISA Kit	96 Test	38220090	24,500.00
CLS0624MO	Mouse CX3C-chemokine/Fractalkine,FKN/CX3CL1 ELISA Kit	96 Test	38220090	24,500.00
CLS0625MO	Mouse FMS-like tyrosine kinase 3,Flt3 ELISA Kit	96 Test	38220090	24,500.00
CLS0626MO	Mouse Soluble Cluster of differentiation 30 ligand,sCD30L ELISA Kit	96 Test	38220090	24,500.00
CLS0627MO	Mouse 17-Hydroxyprogesterone,17-OHP ELISA Kit	96 Test	38220090	24,500.00
CLS0628MO	Mouse Neonatal Thyroxine,NN-T4 ELISA Kit	96 Test	38220090	24,500.00
CLS0629MO	Mouse β -galactosidase, β GAL ELISA Kit	96 Test	38220090	24,500.00
CLS0630MO	Mouse FMS-like tyrosine kinase 3 ligand,Flt-3L ELISA Kit	96 Test	38220090	24,500.00
CLS0631MO	Mouse matrix metalloproteinase 8/Neutrophil collagenase,MMP-8 ELISA Kit	96 Test	38220090	24,500.00
CLS0632MO	Mouse basic fibroblast growth factor 6,bFGF-6 ELISA Kit	96 Test	38220090	24,500.00
CLS0633MO	Mouse Interleukin 9,IL-9 ELISA KIT	96 Test	38220090	24,500.00
CLS0634MO	Mouse macrophage inflammatory protein 3 β ,MIP-3 β	96 Test	38220090	24,500.00
CLS0635MO	Mouse 5-Nucleotidase,5-NT ELISA Kit	96 Test	38220090	24,500.00
CLS0636MO	Mouse Neurotrophin 3,NT-3 ELISA kit	96 Test	38220090	24,500.00
CLS0637MO	Mouse Neurotrophin 4,NT-4 ELISA KIT	96 Test	38220090	24,500.00
CLS0638MO	Mouse matrix metalloproteinase 7,MMP-7 ELISA kit	96 Test	38220090	24,500.00
CLS0639MO	Mouse intercellular adhesion molecule 3,ICAM-3 ELISA	96 Test	38220090	24,500.00
CLS0640MO	Mouse plasminogen activator inhibitor 1,PAI-1 ELISA Kit	96 Test	38220090	24,500.00
CLS0641MO	Mouse Insulin Receptor,INSR ELISA Kit	96 Test	38220090	24,500.00
CLS0642MO	Mouse Fibrinogen Degradation Product,FDP ELISA Kit	96 Test	38220090	24,500.00
CLS0643MO	Mouse alpha-fetoprotein Lens culinaris agglutinin 1(AFP-L1)ELISA Kit	96 Test	38220090	24,500.00
CLS0644MO	Mouse alpha-fetoprotein Lens culinaris agglutinin 2(AFP-L2)ELISA Kit	96 Test	38220090	24,500.00
CLS0645MO	Mouse alpha-fetoprotein Lens culinaris agglutinin 3(AFP-L3)ELISA Kit	96 Test	38220090	24,500.00
CLS0646MO	Mouse Cluster of differentiation 3,CD3 ELISA Kit	96 Test	38220090	24,500.00
CLS0647MO	Mouse Cluster of differentiation 19,CD19 ELISA Kit	96 Test	38220090	24,500.00
CLS0648MO	Mouse carcinoembryonic antigen,CEA ELISA Kit	96 Test	38220090	24,500.00
CLS0649MO	Mouse serine/threonine protein kinase,STK ELISA Kit	96 Test	38220090	24,500.00
CLS0650MO	Mouse small nuclear ribonucleoprotein,snRNP/Sm ELISA Kit	96 Test	38220090	24,500.00
CLS0651MO	Mouse intercellular adhesion molecule 2,ICAM-2/CD102 ELISA Kit	96 Test	38220090	24,500.00
CLS0652MO	Mouse growth hormone releasing hormone,GHRH ELISA Kit	96 Test	38220090	24,500.00
CLS0653MO	Mouse soluble interleukin-1 receptor I ,IL-1sR I ELISA kit	96 Test	38220090	24,500.00
CLS0654MO	Mouse factor B,BF ELISA Kit	96 Test	38220090	24,500.00
CLS0655MO	Mouse Vascular endothelial cell growth factor receptor 1(VEGFR-1/Flt1)ELISA Kit	96 Test	38220090	24,500.00
CLS0656MO	Mouse Thrombopoietin,TPO ELISA kit	96 Test	38220090	24,500.00
CLS0657MO	Mouse Tumor necrosis factor soluble receptor II ,TNFsR-II ELISA KIT	96 Test	38220090	24,500.00
CLS0658MO	Mouse Interleukin-2 receptor,IL-2R/CD122 ELISA kit	96 Test	38220090	24,500.00
CLS0659MO	Mouse GRB10-interacting GYF protein 1,GIGYF1 ELISA Kit	96 Test	38220090	24,500.00
CLS0660MO	Mouse Calf intestinal alkaline phosphatase,CIAP ELISA KIT	96 Test	38220090	24,500.00
CLS0661MO	Mouse Estradiol receptor,ER ELISA Kit	96 Test	38220090	24,500.00
CLS0662MO	Mouse pulmonary surfactant-associated protein A,SP-A ELISA kit	96 Test	38220090	24,500.00
CLS0663MO	Mouse Anti-glucoprotein 210,GP210 ELISA Ki	96 Test	38220090	24,500.00
CLS0664MO	Mouse insulin autoantibodies,IAA ELISA Kit	96 Test	38220090	24,500.00
CLS0665MO	Mouse Collagenase I ELISA Kit	96 Test	38220090	24,500.00

Cat.No.	Product Description	Pack Size	HSN	Unit Price
CLS0666MO	Mouse Collagenase Type II ELISA Kit	96 Test	38220090	24,500.00
CLS0667MO	Mouse Thioredoxin,Trx ELISA Kit	96 Test	38220090	24,500.00
CLS0668MO	Mouse Protein Phosphatase,PP ELISA Kit	96 Test	38220090	24,500.00
CLS0669MO	Mouse major histocompatibility complex- III ,MHC- III/H-2 III	96 Test	38220090	24,500.00
CLS0670MO	Mouse apoptosis inducing factor,AIF ELISA Kit	96 Test	38220090	24,500.00
CLS0671MO	Mouse anti-Thyroid-Peroxidase antibody,TPO-Ab ELISA Kit	96 Test	38220090	24,500.00
CLS0672MO	Mouse major histocompatibility complex- II ,MHC- II/H-2 II	96 Test	38220090	24,500.00
CLS0673MO	Mouse Slit2 ELISA Kit	96 Test	38220090	24,500.00
CLS0674MO	Mouse soluble cluster of differentiation 30,sCD30 Elisa Kit	96 Test	38220090	24,500.00
CLS0675MO	Mouse thioredoxin reductase,TrxR ELISA Kit	96 Test	38220090	24,500.00
CLS0676MO	Mouse orphanin FQ/nociceptin,OFQ/N ELISA Ki	96 Test	38220090	24,500.00
CLS0677MO	Mouse peroxisome proliferators activator receptors alpha,PPAR-α ELISA Kit	96 Test	38220090	24,500.00
CLS0678MO	Mouse monocyte chemotactic protein 4(MCP-4/CCL13)ELISA kit	96 Test	38220090	24,500.00
CLS0679MO	Mouse α1-microglobulin,α1-MG ELISA Kit	96 Test	38220090	24,500.00
CLS0680MO	Mouse Bromodeoxyuridine,BrdU ELISA Kit	96 Test	38220090	24,500.00
CLS0681MO	Mouse Visceral adipose-specific serine protease inhibitor,vaspin ELISA KIT	96 Test	38220090	24,500.00
CLS0682MO	Mouse growth hormone releasing peptide-Ghrelin,GHRP Ghrelin ELISA Kit	96 Test	38220090	24,500.00
CLS0683MO	Mouse lymphocyte factor,LF ELISA Kit	96 Test	38220090	24,500.00
CLS0684MO	Mouse hepatic lipase,HL ELISA Kit	96 Test	38220090	24,500.00
CLS0685MO	Mouse immunoglobulin joining chain,Ig-j ELISA Kit	96 Test	38220090	24,500.00
CLS0686MO	Mouse hepatitis B virus e antibody,HBeAb ELISA Kit	96 Test	38220090	24,500.00
CLS0687MO	Mouse Leptospira IgG,Lep IgG ELISA Kit	96 Test	38220090	24,500.00
CLS0688MO	Mouse α-Glucosidase,α-Glu ELISA Kit	96 Test	38220090	24,500.00
CLS0689MO	Mouse basic fibroblast growth factor 9,bFGF-9 ELISA Kit	96 Test	38220090	24,500.00
CLS0690MO	Mouse basic fibroblast growth factor 4,bFGF-4 ELISA Kit	96 Test	38220090	24,500.00
CLS0691MO	Mouse acidic fibroblast growth factor 1,αFGF-1 ELISA Kit	96 Test	38220090	24,500.00
CLS0692MO	Mouse soluble myosin heavy chain 1,sMHC-1 ELISA Kit	96 Test	38220090	24,500.00
CLS0693MO	Mouse soluble myosin heavy chain 2,sMHC-2 ELISA Kit	96 Test	38220090	24,500.00
CLS0694MO	Mouse Macrophage Inflammatory Protein 1δ,MIP-1δ/CCL15 ELISA kit	96 Test	38220090	24,500.00
CLS0695MO	Mouse amyloid beta peptide 1-42,Aβ1-42 ELISA Kit	96 Test	38220090	24,500.00
CLS0696MO	Mouse osteoclast differentiation factor,ODF ELISA Kit	96 Test	38220090	24,500.00
CLS0697MO	Mouse Toll-like receptor 9,TLR-9 ELISA kit	96 Test	38220090	24,500.00
CLS0698MO	Mouse platelet factor 3, PF-3 ELISA Kit	96 Test	38220090	24,500.00
CLS0699MO	Mouse Beta-Endorphin receptor,β-EPR ELISA Kit	96 Test	38220090	24,500.00
CLS0700MO	Mouse Heat Shock Factor 1,HSF1 ELISA Kit	96 Test	38220090	24,500.00
CLS0701MO	Mouse reduced glutathione,GSH ELISA Ki	96 Test	38220090	24,500.00
CLS0702MO	Mouse Interleukin 1 receptor antagonist,IL-1ra/CD121 ELISA kit	96 Test	38220090	24,500.00
CLS0703MO	Mouse c-jun ELISA Kit	96 Test	38220090	24,500.00
CLS0704MO	Mouse Myoglobin,MYO/MB ELISA Kit	96 Test	38220090	24,500.00
CLS0705MO	Mouse β-catenin,β-cat ELISA Kit	96 Test	38220090	24,500.00
CLS0706MO	Mouse alkaline phosphatase,ALP ELISA Kit	96 Test	38220090	24,500.00
CLS0707MO	Mouse Tissue factor,TF ELISA Kit	96 Test	38220090	24,500.00
CLS0708MO	Mouse Angiopoietin 4,ANG-4 ELISA Kit	96 Test	38220090	24,500.00
CLS0709MO	Mouse Apolipoprotein H/Beta-2-glycoprotein 1,Apo-H ELISA Kit	96 Test	38220090	24,500.00
CLS0710MO	Mouse Linker for activation of T cell,LAT ELISA Kit	96 Test	38220090	24,500.00
CLS0711MO	Mouse phosphatidylinositol antibody IgG/IgM,PI Ab-IgG/IgM	96 Test	38220090	24,500.00
CLS0712MO	Mouse β-Lactamase inhibitors,BLI ELISA Kit	96 Test	38220090	24,500.00
CLS0713MO	Mouse β mannosidase,β Manase ELISA Kit	96 Test	38220090	24,500.00

Cat.No.	Product Description	Pack Size	HSN	Unit Price
CLS0714MO	Mouse β -glucosidase ELISA Kit	96 Test	38220090	24,500.00
CLS0715MO	Mouse Complement 1 inhibitor autoantibody,C1INH ELISA Kit	96 Test	38220090	24,500.00
CLS0716MO	Mouse tyrosine kinase with immunoglobulin-like and EGF-like domains 2,Tie-2 ELISA kit	96 Test	38220090	24,500.00
CLS0717MO	Mouse tissue inhibitors of metalloproteinase 2,TIMP-2 ELISA kit	96 Test	38220090	24,500.00
CLS0718MO	Mouse tissue inhibitors of metalloproteinase 3,TIMP-3 ELISA kit	96 Test	38220090	24,500.00
CLS0719MO	Mouse matrix metalloproteinase 4,MMP-4 ELISA Kit	96 Test	38220090	24,500.00
CLS0720MO	Mouse matrix metalloproteinase 5,MMP-5 ELISA Kit	96 Test	38220090	24,500.00
CLS0721MO	Mouse Tissue-type Plasiminogen Actilyse,t-PA ELISA Kit	96 Test	38220090	24,500.00
CLS0722MO	Mouse Tissue Polypeptide Antigen,TPA ELISA Kit	96 Test	38220090	24,500.00
CLS0723MO	Mouse Insulin-like growth factor binding protein 2,IGFBP 2 ELISA Kit	96 Test	38220090	24,500.00
CLS0724MO	Mouse tissue inhibitors of metalloproteinase 4,TIMP-4 ELISA kit	96 Test	38220090	24,500.00
CLS0725MO	Mouse tumor necrosis factor-related apoptosis-inducing ligand 1(TRAIL-R1)ELISA KIT	96 Test	38220090	24,500.00
CLS0726MO	Mouse G protein-regulated inducer of neurite outgrowth 1,GPRIN1 ELISA Kit	96 Test	38220090	24,500.00
CLS0727MO	Mouse hepatitis B virus surface antigen,HBsAg ELISA Kit	96 Test	38220090	24,500.00
CLS0728MO	Mouse A Disintegrin And Metalloprotease 9 (ADAM9)ELISA Kit	96 Test	38220090	24,500.00
CLS0729MO	Mouse anti-zona pellucida antibody,aZP ELISA Kit	96 Test	38220090	24,500.00
CLS0730MO	Mouse Activated Leukocyte Cell Adhesion Molecule,ALCAM ELISA Kit	96 Test	38220090	24,500.00
CLS0731MO	Mouse Androstenedione,ASD ELISA Kit	96 Test	38220090	24,500.00
CLS0732MO	Mouse Helicobacter pylori IgG, Hp-IgG ELISA Kit	96 Test	38220090	24,500.00
CLS0733MO	Mouse Calretinin,CR ELISA Kit	96 Test	38220090	24,500.00
CLS0734MO	Mouse Dopamine D1 receptor,D1R ELISA Kit	96 Test	38220090	24,500.00
CLS0735MO	Mouse adrenergic alpha-1A receptor,ADRA1A	96 Test	38220090	24,500.00
CLS0736MO	Mouse Hya]uronate binding protein,HABP ELISA Kit	96 Test	38220090	24,500.00
CLS0737MO	Mouse hepatitis B virus e antigen,HBeAg ELISA Kit	96 Test	38220090	24,500.00
CLS0738MO	Mouse Ceruloplasmin,CP/CER ELISA Kit	96 Test	38220090	24,500.00
CLS0739MO	Mouse keyhole limpet hemocyanin,KLH ELISA Kit	96 Test	38220090	24,500.00
CLS0740MO	Mouse β -hexosaminidase A, β -Hex A ELISA Kit	96 Test	38220090	24,500.00
CLS0741MO	Mouse Endothelin 1,ET-1 ELISA Kit	96 Test	38220090	24,500.00
CLS0742MO	Mouse Free Testosterone,F-TESTO ELISA Kit	96 Test	38220090	24,500.00
CLS0743MO	Mouse Resistin(Retn) ELISA Kit	96 Test	38220090	24,500.00
CLS0744MO	Mouse Phospholipidase A2,PL-A2 ELISA Kit	96 Test	38220090	24,500.00
CLS0745MO	Mouse Tissue factor pathway inhibitor,TFPI ELISA Kit	96 Test	38220090	24,500.00
CLS0746MO	Mouse Aquaporin 5,AQP-5 ELISA Kit	96 Test	38220090	24,500.00
CLS0747MO	Mouse anti-alpha-Fodrin IgG/IgA, α -Fodrin IgG/IgA	96 Test	38220090	24,500.00
CLS0748MO	Mouse lipoprotein α ,Lp- α ELISA Kit	96 Test	38220090	24,500.00
CLS0749MO	Mouse coagulation factor X ,F X ELISA Kit	96 Test	38220090	24,500.00
CLS0750MO	Mouse macrophage inflammatory protein 5,MIP-5 ELISA Kit	96 Test	38220090	24,500.00
CLS0751MO	Mouse androgen EIISA Kit	96 Test	38220090	24,500.00
CLS0752MO	Mouse anti-thrombin receptor,ATR ELISA Kit	96 Test	38220090	24,500.00
CLS0753MO	Mouse thrombin receptor,TR ELISA Kit	96 Test	38220090	24,500.00
CLS0754MO	Mouse Heat Shock Protein glycoprotein 96,HSP gp96 ELISA Kit	96 Test	38220090	24,500.00
CLS0755MO	Mouse Krueppel-like factor 5(KLF5) ELISA Kit	96 Test	38220090	24,500.00
CLS0756MO	Mouse soluble Cluster of differentiation 86,sCD86 ELISA Kit	96 Test	38220090	24,500.00
CLS0757MO	Mouse Amylin ELISA Kit	96 Test	38220090	24,500.00
CLS0758MO	Mouse dipeptidyl peptidase 4,DPP4 ELISA Kit	96 Test	38220090	24,500.00
CLS0759MO	Mouse Complement fragment 4a,C4a ELISA Kit	96 Test	38220090	24,500.00
CLS0760MO	Mouse Complement fragment 3a,C3a ELISA Kit	96 Test	38220090	24,500.00

Cat.No.	Product Description	Pack Size	HSN	Unit Price
CLS0761MO	Mouse toxic shock syndrome toxin,TSST-1 ELISA Kit	96 Test	38220090	24,500.00
CLS0762MO	Mouse Heat Shock Protein 90,Hsp-90 ELISA Kit	96 Test	38220090	24,500.00
CLS0763MO	Mouse Heat Shock Protein 70,Hsp-70 ELISA Kit	96 Test	38220090	24,500.00
CLS0764MO	Mouse Heat Shock Protein 40,Hsp-40 ELISA Kit	96 Test	38220090	24,500.00
CLS0765MO	Mouse Heat Shock Protein 20,Hsp-20 ELISA Kit	96 Test	38220090	24,500.00
CLS0766MO	Mouse Crestine phosphokinase,CPK ELISA Kit	96 Test	38220090	24,500.00
CLS0767MO	Mouse Histone Deacetylase,HD ELISA Kit	96 Test	38220090	24,500.00
CLS0768MO	Mouse Methylase ELISA Kit	96 Test	38220090	24,500.00
CLS0769MO	Mouse proliferating cell nuclear antigen antibody,PCNA ELISA Kit	96 Test	38220090	24,500.00
CLS0770MO	Mouse β 2-glycoprotein 1 antibody IgA/G/M, β 2-GP1 IgA/G/M ELISA Kit	96 Test	38220090	24,500.00
CLS0771MO	Mouse pyridinium crosslink/PyriLinks,PY ELISA Kit	96 Test	38220090	24,500.00
CLS0772MO	Mouse transferrin receptor,TFR ELISA Kit	96 Test	38220090	24,500.00
CLS0773MO	Mouse Bone-specific Alkphase B,ALP-B ELISA Kit	96 Test	38220090	24,500.00
CLS0774MO	Mouse tyrosine kinase with immunoglobulin-like and EGF-like domains 1,Tie1 ELISA kit	96 Test	38220090	24,500.00
CLS0775MO	Mouse Endocrine gland vascular endothelial growth factor(EG-VEGF)ELISA Kit	96 Test	38220090	24,500.00
CLS0776MO	Mouse 1,3- β D glucosidase,1,3- β D-Glu ELISA Kit	96 Test	38220090	24,500.00
CLS0777MO	Mouse Ciliary Neurotrophic Factor,CNTF ELISA Kit	96 Test	38220090	24,500.00
CLS0778MO	Mouse beta celluln,BTC ELISA Kit	96 Test	38220090	24,500.00
CLS0779MO	Mouse Midkine,MK ELISA Kit	96 Test	38220090	24,500.00
CLS0780MO	Mouse Cyclin-D2 ELISA Kit	96 Test	38220090	24,500.00
CLS0781MO	Mouse Cyclin-D3 ELISA Kit	96 Test	38220090	24,500.00
CLS0782MO	Mouse Cystatin C,Cys-C ELISA Kit	96 Test	38220090	24,500.00
CLS0783MO	Mouse Factor VIII-related Antigen,FVIII _{Ag} ELISA Kit	96 Test	38220090	24,500.00
CLS0784MO	Mouse Pyruvate kinase isozymes M1/M2,M2-PK ELISA Kit	96 Test	38220090	24,500.00
CLS0785MO	Mouse galactose-6-sulphate sulphatase,Gal-6S ELISA Kit	96 Test	38220090	24,500.00
CLS0786MO	Mouse β -glucuronidase, β GD ELISA Kit	96 Test	38220090	24,500.00
CLS0787MO	Mouse Ureaplasma urealyticum antibody,UU-Ab ELISA Kit	96 Test	38220090	24,500.00
CLS0788MO	Mouse L-phenylalanine,LPA ELISA Kit	96 Test	38220090	24,500.00
CLS0789MO	Mouse CA724 ELISA Kit	96 Test	38220090	24,500.00
CLS0790MO	Mouse pyruvate kinase,PK ELISA Kit	96 Test	38220090	24,500.00
CLS0791MO	Mouse Glucose dependent insulin releasing polypeptide,GIP ELISA Kit	96 Test	38220090	24,500.00
CLS0792MO	Mouse Glycogen phosphorylase II,GP-II ELISA Kit	96 Test	38220090	24,500.00
CLS0793MO	Mouse 5-Hydroxytryptamine,5HT ELISA Kit	96 Test	38220090	24,500.00
CLS0794MO	Mouse substance P receptor,SP-R ELISA Kit	96 Test	38220090	24,500.00
CLS0795MO	Mouse Mannma binding protein/mannan binding lectin,MBP/MBL ELISA Kit	96 Test	38220090	24,500.00
CLS0796MO	Mouse Annexin A2,Anxa2 ELISA Kit	96 Test	38220090	24,500.00
CLS0797MO	Mouse Endometrium Antibody,EMAb ELISA Kit	96 Test	38220090	24,500.00
CLS0798MO	Mouse Low Density Lipoprotein immune complex,LDL-IC ELISA Kit	96 Test	38220090	24,500.00
CLS0799MO	Mouse glial fibrillary acidic protein,GFAP ELISA Kit	96 Test	38220090	24,500.00
CLS0800MO	Mouse Perinuclear anti-neutrophil cytoplasmic antibody,pANCA ELISA Kit	96 Test	38220090	24,500.00
CLS0801MO	Mouse 15-lipoxygenase,15-LO/LOX ELISA Kit	96 Test	38220090	24,500.00
CLS0802MO	Mouse Copeptin ELISA Kit	96 Test	38220090	24,500.00
CLS0803MO	Mouse cluster Of differentiation,CD34 ELISA Kit	96 Test	38220090	24,500.00
CLS0804MO	Mouse secreted phospholipase A2,sPLA2 ELISA Kit	96 Test	38220090	24,500.00
CLS0805MO	Mouse heme oxygenase 2,HO-2 ELISA Kit	96 Test	38220090	24,500.00
CLS0806MO	Mouse Crosslaps,Cr ELISA Kit	96 Test	38220090	24,500.00
CLS0807MO	Mouse cross-linked C-telopeptides of Type I collagen,C I CP ELISA Kit	96 Test	38220090	24,500.00
CLS0808MO	Mouse deoxyypyridinoline,DPD ELISA Kit	96 Test	38220090	24,500.00

Cat.No.	Product Description	Pack Size	HSN	Unit Price
CLS0809MO	Mouse lipoprotein-associated phospholipase A2,Lp-PL-A2 ELISA Kit	96 Test	38220090	24,500.00
CLS0810MO	Mouse alpha-L-fucosidase,AFU ELISA Kit	96 Test	38220090	24,500.00
CLS0811MO	Mouse 16- α Hydroxyestrogen 1,16- α OHE-1 ELISA Kit	96 Test	38220090	24,500.00
CLS0812MO	Mouse cholest erolester transfer protein,CETP ELISA Kit	96 Test	38220090	24,500.00
CLS0813MO	Mouse Thyroid-Peroxidase,TPO ELISA Kit	96 Test	38220090	24,500.00
CLS0814MO	Mouse tenascin,TN ELISA Kit	96 Test	38220090	24,500.00
CLS0815MO	Mouse Vasoactive Intestinal Peptide,VIP ELISA Kit	96 Test	38220090	24,500.00
CLS0816MO	Mouse atrial natriuretic factor,ANF ELISA Kit	96 Test	38220090	24,500.00
CLS0817MO	Mouse mannan binding lectin associated serine protease(MASP) ELISA Kit	96 Test	38220090	24,500.00
CLS0818MO	Mouse anti-Glucose transporter 4 antibody,anti-GLUT4 ELISA Kit	96 Test	38220090	24,500.00
CLS0819MO	Mouse Complement 1 inhibitor,C1INH ELISA Kit	96 Test	38220090	24,500.00
CLS0820MO	Mouse anti-IgE receptor antibody ELISA Kit	96 Test	38220090	24,500.00
CLS0821MO	Mouse anti-IVIgG antibody ELISA Kit	96 Test	38220090	24,500.00
CLS0822MO	Mouse Anti-myocardial antibody,AMA ELISA Kit	96 Test	38220090	24,500.00
CLS0823MO	Mouse p53/tumor protein,p53/TP53 ELISA Kit	96 Test	38220090	24,500.00
CLS0824MO	Mouse anti-nucleosome antibody IgG,AnuA-IgG ELISA Kit	96 Test	38220090	24,500.00
CLS0825MO	Mouse 12-lipoxygenase,LOX-12 ELISA Kit	96 Test	38220090	24,500.00
CLS0826MO	Mouse protein kinase K9,PKK9 ELISA Kit	96 Test	38220090	24,500.00
CLS0827MO	Mouse melanopsin,MEL ELISA Kit	96 Test	38220090	24,500.00
CLS0828MO	Mouse Homocysteic acid,Hcy ELISA Kit	96 Test	38220090	24,500.00
CLS0829MO	Mouse glucocorticoid receptor- β ,GR- β ELISA Kit	96 Test	38220090	24,500.00
CLS0830MO	Mouse Interleukin 34,IL-34 ELISA Kit	96 Test	38220090	24,500.00
CLS0831MO	Mouse skeletal muscle Actinin- α ,sm Actinin- α ELISA Kit	96 Test	38220090	24,500.00
CLS0832MO	Mouse major histocompatibility complex I ,MHC I /H-2 I ELISA Kit	96 Test	38220090	24,500.00
CLS0833MO	Mouse Epithelial neutrophil activating peptide 78,ENA-78 ELISA Kit	96 Test	38220090	24,500.00
CLS0834MO	Mouse GATA binding protein 4,GATA4 ELISA Kit	96 Test	38220090	24,500.00
CLS0835MO	Mouse interferon-inducible protein 10,IP-10 ELISA Kit	96 Test	38220090	24,500.00
CLS0836MO	Mouse G1/S-specific Cyclin-D1,Cyclin-D1 ELISA Kit	96 Test	38220090	24,500.00
CLS0837MO	Mouse Apolipoprotein M,Apo-M ELISA Kit	96 Test	38220090	24,500.00
CLS0838MO	Mouse Ultrasensitivity Thyroxine,u-T4 ELISA Kit	96 Test	38220090	24,500.00
CLS0839MO	Mouse anti-cardiolipin antibody IgA,ACA-IgA ELISA Kit	96 Test	38220090	24,500.00
CLS0840MO	Mouse granzymes B,Gzms-B ELISA Kit	96 Test	38220090	24,500.00
CLS0841MO	Mouse granzymes A,Gzms-A ELISA Kit	96 Test	38220090	24,500.00
CLS0842MO	Mouse anti-cardiolipin antibody IgM,ACA-IgM ELISA Kit	96 Test	38220090	24,500.00
CLS0843MO	Mouse anti-cardiolipin antibody IgG,ACA-IgG ELISA Kit	96 Test	38220090	24,500.00
CLS0844MO	Mouse Vitamin K1,VK1 ELISA Kit	96 Test	38220090	24,500.00
CLS0845MO	Mouse Inhibin binding protein,INHBP ELISA Kit	96 Test	38220090	24,500.00
CLS0846MO	Mouse Vitamin D3,VD3 ELISA Kit	96 Test	38220090	24,500.00
CLS0847MO	Mouse Vitamin D2,VD2 ELISA Kit	96 Test	38220090	24,500.00
CLS0848MO	Mouse Vitamin E,VE ELISA Kit	96 Test	38220090	24,500.00
CLS0849MO	Mouse Vitamin A,VA ELISA Kit	96 Test	38220090	24,500.00
CLS0850MO	Mouse telomerase,TE ELISA Kit	96 Test	38220090	24,500.00
CLS0851MO	Mouse Desmin,Des ELISA Kit	96 Test	38220090	24,500.00
CLS0852MO	Mouse Myosin,MYS ELISA Kit	96 Test	38220090	24,500.00
CLS0853MO	Mouse calcium channel blockers,CCB ELISA Kit	96 Test	38220090	24,500.00
CLS0854MO	Mouse phospho-extracellularsignal-regulatedkinase(pERK)ELISA Kit	96 Test	38220090	24,500.00
CLS0855MO	Mouse Bladder tumor antigen,BTA ELISA Kit	96 Test	38220090	24,500.00
CLS0856MO	Mouse Platelet-Derived Growth Factor-BB,PDGF-BB ELISA kit	96 Test	38220090	24,500.00
CLS0857MO	Mouse Alternative macrophage activation-associated CC chemokine 1(AmAC-1)ELISA Kit	96 Test	38220090	24,500.00
CLS0858MO	Mouse bone morphogenetic proteins,BMPs ELISA Kit	96 Test	38220090	24,500.00

Cat.No.	Product Description	Pack Size	HSN	Unit Price
CLS0859MO	Mouse Mucin-7,MUC7 ELISA Ki	96 Test	38220090	24,500.00
CLS0860MO	Mouse Thrombin activatable fibrinolysis inhibitor,TAFI ELISA Kit	96 Test	38220090	24,500.00
CLS0861MO	Mouse platelet membrane glycoprotein IIb/IIIa,GP-IIb/IIIa/CD41+CD61 ELISA Kit	96 Test	38220090	24,500.00
CLS0862MO	Mouse Surface Membrane Immunoglobulin,Smlg ELISA Kit	96 Test	38220090	24,500.00
CLS0863MO	Mouse heat shock protein 27,HSP-27 ELISA Kit	96 Test	38220090	24,500.00
CLS0864MO	Mouse Dipeptidase 2(DPEP2) ELISA Kit	96 Test	38220090	24,500.00
CLS0865MO	Mouse Mothers against decapentaplegic homolog 1,Smad1 ELISA Kit	96 Test	38220090	24,500.00
CLS0866MO	Mouse CXC-chemokine receptor 3,CXCR3 ELISA Kit	96 Test	38220090	24,500.00
CLS0867MO	Mouse oxidized lowdensity lipoprotein antibody,OLAb ELISA	96 Test	38220090	24,500.00
CLS0868MO	Mouse platelet antibodies IgG/M/A,PA-IgG/M/A	96 Test	38220090	24,500.00
CLS0869MO	Mouse regulated on activation in normal T-cell expressed and secreted,RANTES/CCL5 ELISA kit	96 Test	38220090	24,500.00
CLS0870MO	Mouse D-Lactate Dehydrogenase,D-LDH ELISA Kit	96 Test	38220090	24,500.00
CLS0871MO	Mouse insulin-degrading enzyme,IDE ELISA Kit	96 Test	38220090	24,500.00
CLS0872MO	Mouse TGF-beta-inducible early response gene-1,TIEG1 ELISA Kit	96 Test	38220090	24,500.00
CLS0873MO	Mouse anti-thyroid-globulin antibody,TGAB ELISA Kit	96 Test	38220090	24,500.00
CLS0874MO	Mouse 6-keto-prostaglandin F1a,6-K-PGF1a ELISA Kit	96 Test	38220090	24,500.00
CLS0875MO	Mouse Retinol-binding protein 4,RBP-4 ELISA Kit	96 Test	38220090	24,500.00
CLS0876MO	Mouse melanocyte antibody,MC Ab ELISA Kit	96 Test	38220090	24,500.00
CLS0877MO	Mouse angiotensin I ,Ang- I ELISA Kit	96 Test	38220090	24,500.00
CLS0878MO	Mouse lymphotactin,Lptn/LTN ELISA Kit	96 Test	38220090	24,500.00
CLS0879MO	Mouse annexin V ,ANX- V ELISA Kit	96 Test	38220090	24,500.00
CLS0880MO	Mouse anti-endothelial cell antibody,AECA ELISA Kit	96 Test	38220090	24,500.00
CLS0881MO	Mouse intact Parathormone ,i-PTH ELISA Kit	96 Test	38220090	24,500.00
CLS0882MO	Mouse anti-Endomysial Antibody IgA,EMA IgA ELISA Kit	96 Test	38220090	24,500.00
CLS0883MO	Mouse ferritin,FE ELISA Kit	96 Test	38220090	24,500.00
CLS0884MO	Mouse Aquaporin 2,AQP-2 ELISA Kit	96 Test	38220090	24,500.00
CLS0885MO	Mouse Aquaporin 0,AQP-0 ELISA Kit	96 Test	38220090	24,500.00
CLS0886MO	Mouse Glycogen phosphorylase MM,GP-MM ELISA Kit	96 Test	38220090	24,500.00
CLS0887MO	Mouse Aquaporin 1,AQP-1 ELISA Kit	96 Test	38220090	24,500.00
CLS0888MO	Mouse Glycogen phosphorylase BB,GP-BB ELISA Kit	96 Test	38220090	24,500.00
CLS0889MO	Mouse Aquaporin 3,AQP-3 ELISA Kit	96 Test	38220090	24,500.00
CLS0890MO	Mouse Interleukin 27,IL-27 ELISA Kit	96 Test	38220090	24,500.00
CLS0891MO	Mouse Thyroxine antibody,TAb ELISA Kit	96 Test	38220090	24,500.00
CLS0892MO	Mouse Endothelial lipase,EL ELISA Kit	96 Test	38220090	24,500.00
CLS0893MO	Mouse carbonic anhydrase,CA ELISA Kit	96 Test	38220090	24,500.00
CLS0894MO	Mouse ovarian cancer marker-CA125 ELISA Kit	96 Test	38220090	24,500.00
CLS0895MO	Mouse mammary carcinoma Marker-CA153 ELISA Kit	96 Test	38220090	24,500.00
CLS0896MO	Mouse Gastrointestinalcancer Marker-CA199 ELISA Kit	96 Test	38220090	24,500.00
CLS0897MO	Mouse carbonic anhydrase 2,CA-2 ELISA Kit	96 Test	38220090	24,500.00
CLS0898MO	Mouse brain-gut peptides,BGP/Ghrelin Elisa kit	96 Test	38220090	24,500.00
CLS0899MO	Mouse 6-keto-prostaglandin,6-K-PG ELISA Kit	96 Test	38220090	24,500.00
CLS0900MO	Mouse Chorionic Gonadotrophin β,β-CG ELISA Kit	96 Test	38220090	24,500.00
CLS0901MO	Mouse Dehydroepiandrosterone S7,DHEA-S7 ELISA Kit	96 Test	38220090	24,500.00
CLS0902MO	Mouse dipeptidyl peptidase 8,DPP8 ELISA Kit	96 Test	38220090	24,500.00
CLS0903MO	Mouse Tumor Specific Growth Factor/tumor supplied group of factor(TSGF)ELISA Kit	96 Test	38220090	24,500.00
CLS0904MO	Mouse Osteoprotegerin Ligand,OPGL ELISA Kit	96 Test	38220090	24,500.00
CLS0905MO	Mouse Hexokinase,HK ELISA Kit	96 Test	38220090	24,500.00
CLS0906MO	Mouse Hyaluronan synthase 2,HAS2 ELISA Kit	96 Test	38220090	24,500.00
CLS0907MO	Mouse Motilin,MTL ELISA Kit	96 Test	38220090	24,500.00
CLS0908MO	Mouse major histocompatibility complex I ,MHC I /H-2 I	96 Test	38220090	24,500.00

Cat.No.	Product Description	Pack Size	HSN	Unit Price
CLS0909MO	Mouse myelin basic protein,MBP ELISA Kit	96 Test	38220090	24,500.00
CLS0910MO	Mouse Prostatic Acid Phosphatase,PAP ELISA Kit	96 Test	38220090	24,500.00
CLS0911MO	Mouse receptor activator of nuclear factor kappa B ligand,RANKL ELISA Kit	96 Test	38220090	24,500.00
CLS0912MO	Mouse thrombus precursor protein, Tpp ELISA Kit	96 Test	38220090	24,500.00
CLS0913MO	Mouse inhibin B,INH-B ELISA Kit	96 Test	38220090	24,500.00
CLS0914MO	Mouse Prostaglandin E1,PGE1 ELISA Kit	96 Test	38220090	24,500.00
CLS0915MO	Mouse Prostaglandin F,PG-F ELISA Kit	96 Test	38220090	24,500.00
CLS0916MO	Mouse 17-ketosteroids,17-KS ELISA Ki	96 Test	38220090	24,500.00
CLS0917MO	Mouse 25-Dihydroxy vitamin D3,HVD3 ELISA Kit	96 Test	38220090	24,500.00
CLS0918MO	Mouse soluble interleukin-2 receptor,IL-2sRβ ELISA kit	96 Test	38220090	24,500.00
CLS0919MO	Mouse monocyte chemotactic protein 1/monocyte chemotactic and activating factor(MCP-1/CCL2/MCAF)ELISA Kit	96 Test	38220090	24,500.00
CLS0920MO	Mouse monocyte chemotactic protein 2,MCP-2 ELISA kit	96 Test	38220090	24,500.00
CLS0921MO	Mouse monocyte chemotactic protein 3,MCP-3 ELISA kit	96 Test	38220090	24,500.00
CLS0922MO	Mouse anti-centrol and centrosome antibody,ACA ELISA Kit	96 Test	38220090	24,500.00
CLS0923MO	Mouse Chorionic Gonadotrophin,CG ELISA Kit	96 Test	38220090	24,500.00
CLS0924MO	Mouse phosphatidylserine,PS ELISA Kit	96 Test	38220090	24,500.00
CLS0925MO	Mouse choline phosphoglyceride,PC/CPG ELISA Kit	96 Test	38220090	24,500.00
CLS0926MO	Mouse leukocyte Selectin,L-Selectin ELISA kit	96 Test	38220090	24,500.00
CLS0927MO	Mouse neurofilament protein,NF ELISA Kit	96 Test	38220090	24,500.00
CLS0928MO	Mouse single stranded DNA Antibody,ssDNA ELISA KIT	96 Test	38220090	24,500.00
CLS0929MO	Mouse pituitary adenylate cyclase activating polypeptide,PACAP ELISA Kit	96 Test	38220090	24,500.00
CLS0930MO	Mouse pregnancy associated plasma protein A,PAPP-A ELISA Kit	96 Test	38220090	24,500.00
CLS0931MO	Mouse Pentosidine ELISA Kit	96 Test	38220090	24,500.00
CLS0932MO	Mouse Retinol-binding protein,RBP ELISA Kit	96 Test	38220090	24,500.00
CLS0933MO	Mouse N-Acetyl-Ser-Asp-Lys-Pro,AcSDKP ELISA Kit	96 Test	38220090	24,500.00
CLS0934MO	Mouse membrane IgA,mIgA ELISA Kit	96 Test	38220090	24,500.00
CLS0935MO	Mouse Colon Cancer Antigen,CCA ELISA Kit	96 Test	38220090	24,500.00
CLS0936MO	Mouse regenerating gene IV,REG-4 ELISA Kit	96 Test	38220090	24,500.00
CLS0937MO	Mouse Toll-like receptor 7,TLR7 ELISA Kit	96 Test	38220090	24,500.00
CLS0938MO	Mouse protein tyrosine phosphatase,PTP/PTPase ELISA Kit	96 Test	38220090	24,500.00
CLS0939MO	Mouse Thrombin, TM ELISA Kit	96 Test	38220090	24,500.00
CLS0940MO	Mouse Creatine Kinase,CK ELISA kit	96 Test	38220090	24,500.00
CLS0941MO	Mouse myelin basic protein autoantibody,MBP ELISA Kit	96 Test	38220090	24,500.00
CLS0942MO	Mouse Interleukin 21,IL-21 ELISA Kit	96 Test	38220090	24,500.00
CLS0943MO	Mouse islet cell antibody,ICA ELISA Kit	96 Test	38220090	24,500.00
CLS0944MO	Mouse anti-Monocyte antibody,AMA ELISA Kit	96 Test	38220090	24,500.00
CLS0945MO	Mouse Anti-Smooth Muscle Antibody,ASMA ELISA Kit	96 Test	38220090	24,500.00
CLS0946MO	Mouse Embryonic Stem MESPU30,M30 ELISA Kit	96 Test	38220090	24,500.00
CLS0947MO	Mouse 8-iso prostaglandin(8-iso-PG) ELISA Kit	96 Test	38220090	24,500.00
CLS0948MO	Mouse BH3 interacting domain death agonist,Bid ELISA Kit	96 Test	38220090	24,500.00
CLS0949MO	Mouse Caspase-9 ELISA Kit	96 Test	38220090	24,500.00
CLS0950MO	Mouse heat shock protein 60,hSP-60 ELISA Kit	96 Test	38220090	24,500.00
CLS0951MO	Mouse A Disintegrin And Metalloprotease 8 (ADAM8)ELISA Kit	96 Test	38220090	24,500.00
CLS0952MO	Mouse Ultrasensitivity Tri-iodothyronine,u-T3 ELISA Kit	96 Test	38220090	24,500.00
CLS0953MO	Mouse CXC-chemokine ligand 16,CXCL16 ELISA Kit	96 Test	38220090	24,500.00
CLS0954MO	Mouse glycogen synthase kinase, GSK ELISA Kit	96 Test	38220090	24,500.00
CLS0955MO	Mouse angiotensinogen,aGT ELISA Kit	96 Test	38220090	24,500.00
CLS0956MO	Mouse Terminal Complement Complex C5b-9 (TCC C5b-9)ELISA Kit	96 Test	38220090	24,500.00
CLS0957MO	Mouse Platelet-Derived Growth Factor Soluble Receptor α(PDGFR-α)ELISA Kit	96 Test	38220090	24,500.00

Cat.No.	Product Description	Pack Size	HSN	Unit Price
CLS0958MO	Mouse platelet Selectin,P-Selectin ELISA kit	96 Test	38220090	24,500.00
CLS0959MO	Mouse Insulin-like growth factor binding protein 1,IGFBP 1 ELISA Kit	96 Test	38220090	24,500.00
CLS0960MO	Mouse L-Phenylalanine ammonla-lyase,PAL ELISA Kit	96 Test	38220090	24,500.00
CLS0961MO	Mouse Leukemia inhibitory factor,LIF ELISA kit	96 Test	38220090	24,500.00
CLS0962MO	Mouse Macrophage Colony-Stimulating Factor,M-CSF ELISA kit	96 Test	38220090	24,500.00
CLS0963MO	Mouse Leptin receptor,LR/Ob-R ELISA KIT	96 Test	38220090	24,500.00
CLS0964MO	Mouse Macrophage Inflammatory Protein 1 β ,MIP-1 β ELISA ki	96 Test	38220090	24,500.00
CLS0965MO	Mouse coagulation factor II,FII ELISA Kit	96 Test	38220090	24,500.00
CLS0966MO	Mouse osteonectin,ON ELISA Kit	96 Test	38220090	24,500.00
CLS0967MO	Mouse histon-H2b ELISA Kit	96 Test	38220090	24,500.00
CLS0968MO	Mouse glucocorticoid receptor,GR ELISA Kit	96 Test	38220090	24,500.00
CLS0969MO	Mouse Insulin Like Growth Factor Binding Protein 6 (IGFBP6)ELISA Kit	96 Test	38220090	24,500.00
CLS0970MO	Mouse Macrophage Inflammatory Protein 3 α ,MIP-3 α ELISA kit	96 Test	38220090	24,500.00
CLS0971MO	Mouse α 2-plasmin inhibitor, α 2-PI ELISA Kit	96 Test	38220090	24,500.00
CLS0972MO	Mouse α 2-Antiplasmin, α 2-AP ELISA Ki	96 Test	38220090	24,500.00
CLS0973MO	Mouse Vascuoar endothelial cell growth factor receptor 2,(VEGFR-2/Flk-1)ELISA Kit	96 Test	38220090	24,500.00
CLS0974MO	Mouse soluble platelet endothelial cell adhesion molecule 1(sPECAM-1/sCD31)ELISA Kit	96 Test	38220090	24,500.00
CLS0975MO	Mouse Vascular cell adhesion molecule 1,VCAM-1 ELISA kit	96 Test	38220090	24,500.00
CLS0976MO	Mouse Ischemia Modified Albumin,IMA ELISA Kit	96 Test	38220090	24,500.00
CLS0977MO	Mouse Pro Atrial Natriuretic Peptide,Pro-ANP ELISA Kit	96 Test	38220090	24,500.00
CLS0978MO	Mouse tumor necrosis factor-related apoptosis-inducing ligand 3(TRAIL-R3)ELISA Kit	96 Test	38220090	24,500.00
CLS0979MO	Mouse soluble tumor necrosis factor-related apoptosis inducing ligand,sTRAIL ELISA KIT	96 Test	38220090	24,500.00
CLS0980MO	Mouse tumor necrosis factor-related apoptosis-inducing ligand 4(TRAIL-R4)ELISA Kit	96 Test	38220090	24,500.00
CLS0981MO	Mouse urokinase plasminogen activator,uPA ELISA kit	96 Test	38220090	24,500.00
CLS0982MO	Mouse Urokinase-type Plasminogen Activator Receptor,PLAUR/uPAR ELISA Kit	96 Test	38220090	24,500.00
CLS0983MO	Mouse Vascular Endothelial cell Growth Factor B,VEGF-B ELISA kit	96 Test	38220090	24,500.00
CLS0984MO	Mouse Platelet Factor 4,PF-4 ELISA Kit	96 Test	38220090	24,500.00
CLS0985MO	Mouse anti-sperm antibody,AsAb ELISA Kit	96 Test	38220090	24,500.00
CLS0986MO	Mouse Vitamin C,VC ELISA Kit	96 Test	38220090	24,500.00
CLS0987MO	Mouse Vitamin B6,VB6 ELISA Kit	96 Test	38220090	24,500.00
CLS0988MO	Mouse acetylcholine,ACH ELISA Kit	96 Test	38220090	24,500.00
CLS0989MO	Mouse leukemia inhibitory factor receptor,LIFR ELISA Kit	96 Test	38220090	24,500.00
CLS0990MO	Mouse neuropeptide Y,NP-Y ELISA Kit	96 Test	38220090	24,500.00
CLS0991MO	Mouse Growth Hormone Releasing Peptide,GHRP ELISA Kit	96 Test	38220090	24,500.00
CLS0992MO	Mouse Gelsolin ELISA Kit	96 Test	38220090	24,500.00
CLS0993MO	Mouse Insulin Receptor β ,ISR- β ELISA KIT	96 Test	38220090	24,500.00
CLS0994MO	Mouse Insulin Like Growth Factor Binding Protein 7 (IGFBP7)ELISA Kit	96 Test	38220090	24,500.00
CLS0995MO	Mouse Amphiregulin B (AREGB)ELISA Kit	96 Test	38220090	24,500.00
CLS0996MO	Mouse A Disintegrin And Metalloprotease 19 (ADAM19)ELISA Kit	96 Test	38220090	24,500.00
CLS0997MO	Mouse N-Acetyl Alpha-D-Glucosaminidase (NAGLU)ELISA kit	96 Test	38220090	24,500.00
CLS0998MO	Mouse O-Fucosylpeptide-3-Beta-N-Acetylglucosaminyltransferase (RFNG)ELISA kit	96 Test	38220090	24,500.00

Cat.No.	Product Description	Pack Size	HSN	Unit Price
CLS0999MO	Mouse Phosphoglycerate Dehydrogenase (PHGDH)ELISA kit	96 Test	38220090	24,500.00
CLS1000MO	Mouse Sodium/Glucose Cotransporter 1 (SGLT1)ELISA kit	96 Test	38220090	24,500.00
CLS1001MO	Mouse Sodium/Glucose Cotransporter 2 (SGLT2)ELISA kit	96 Test	38220090	24,500.00
CLS1002MO	Mouse Sodium/Glucose Cotransporter 3 (SGLT3)ELISA kit	96 Test	38220090	24,500.00
CLS1003MO	Mouse Sodium/Glucose Cotransporter 4 (SGLT4)ELISA kit	96 Test	38220090	24,500.00
CLS1004MO	Mouse Sodium/Glucose Cotransporter 5 (SGLT5)ELISA kit	96 Test	38220090	24,500.00
CLS1005MO	Mouse Glucose-6-Phosphatase, Catalytic (G6PC)ELISA kit	96 Test	38220090	24,500.00
CLS1006MO	Mouse Glucoside Xylosyltransferase 1 (GXYLT1)ELISA kit	96 Test	38220090	24,500.00
CLS1007MO	Mouse Glucoside Xylosyltransferase 2 (GXYLT2)ELISA kit	96 Test	38220090	24,500.00
CLS1008MO	Mouse Phosphoglucomutase 1 (PGM1)ELISA kit	96 Test	38220090	24,500.00
CLS1009MO	Mouse Phosphoglucomutase 2 (PGM2)ELISA kit	96 Test	38220090	24,500.00
CLS1010MO	Mouse Phosphoglucomutase 2 Like Protein 1 (PGM2L1)ELISA kit	96 Test	38220090	24,500.00
CLS1011MO	Mouse Phosphoglucomutase 3 (PGM3)ELISA kit	96 Test	38220090	24,500.00
CLS1012MO	Mouse Phosphoglucomutase 5 (PGM5)ELISA kit	96 Test	38220090	24,500.00
CLS1013MO	Mouse Glucose Transporter 10 (GLUT10)ELISA kit	96 Test	38220090	24,500.00
CLS1014MO	Mouse Glucose Transporter 11 (GLUT11)ELISA kit	96 Test	38220090	24,500.00
CLS1015MO	Mouse Glucose Transporter 12 (GLUT12)ELISA kit	96 Test	38220090	24,500.00
CLS1016MO	Mouse Glucose Transporter 14 (GLUT14)ELISA kit	96 Test	38220090	24,500.00
CLS1017MO	Mouse Glucose Transporter 2 (GLUT2)ELISA kit	96 Test	38220090	24,500.00
CLS1018MO	Mouse Glucose Transporter 5 (GLUT5)ELISA kit	96 Test	38220090	24,500.00
CLS1019MO	Mouse Glucose Transporter 6 (GLUT6)ELISA kit	96 Test	38220090	24,500.00
CLS1020MO	Mouse Glucose Transporter 7 (GLUT7)ELISA kit	96 Test	38220090	24,500.00
CLS1021MO	Mouse Glucose Transporter 8 (GLUT8)ELISA kit	96 Test	38220090	24,500.00
CLS1022MO	Mouse Glucose Transporter 9 (GLUT9)ELISA kit	96 Test	38220090	24,500.00
CLS1023MO	Mouse Glucosidase Beta, Acid (GbA)ELISA kit	96 Test	38220090	24,500.00
CLS1024MO	Mouse Aspartylglucosaminidase(AGA)ELISA kit	96 Test	38220090	24,500.00
CLS1025MO	Mouse 12-Hydroxyeicosatetraenoic Acid (12-HETE)ELISA kit	96 Test	38220090	24,500.00
CLS1026MO	Mouse Fc Fragment Of IgG Binding Protein (FcγBP)ELISA kit	96 Test	38220090	24,500.00
CLS1027MO	Mouse Opioid Peptide (OP)ELISA kit	96 Test	38220090	24,500.00
CLS1028MO	Mouse Carcinoembryonic Antigen Related Cell Adhesion Molecule 1 (CEACAM1)ELISA kit	96 Test	38220090	24,500.00
CLS1029MO	Mouse Carcinoembryonic Antigen Related Cell Adhesion Molecule 6 (CEACAM6)ELISA kit	96 Test	38220090	24,500.00
CLS1030MO	Mouse Carcinoembryonic Antigen Related Cell Adhesion Molecule 7 (CEACAM7)ELISA kit	96 Test	38220090	24,500.00
CLS1031MO	Mouse Carcinoembryonic Antigen Related Cell Adhesion Molecule 8 (CEACAM8)ELISA kit	96 Test	38220090	24,500.00
CLS1032MO	Mouse Interleukin 1 Receptor Associated Kinase 2 (IRAK2)ELISA kit	96 Test	38220090	24,500.00
CLS1033MO	Mouse Leukocyte Elastase Inhibitor (LEI)ELISA kit	96 Test	38220090	24,500.00
CLS1034MO	Mouse Cysteine Rich Transmembrane BMP Regulator 1 (CRIM1)ELISA kit	96 Test	38220090	24,500.00
CLS1035MO	Mouse Sirtuin 7 (SIRT7)ELISA kit	96 Test	38220090	24,500.00
CLS1036MO	Mouse BMP And Activin Membrane Bound Inhibitor Homolog (BAMBI)ELISA kit	96 Test	38220090	24,500.00
CLS1037MO	Mouse Protein Tyrosine Phosphatase Receptor Type G (PTPRG)ELISA kit	96 Test	38220090	24,500.00
CLS1038MO	Mouse Calcineurin (CaN)ELISA kit	96 Test	38220090	24,500.00
CLS1039MO	Mouse Phospholipase A2, Calcium Independent (iPLA2)ELISA kit	96 Test	38220090	24,500.00

Cat.No.	Product Description	Pack Size	HSN	Unit Price
CLS1040MO	Mouse ATPase, Ca ⁺⁺ Transporting, Plasma Membrane 2 (ATP2B2)ELISA kit	96 Test	38220090	24,500.00
CLS1041MO	Mouse Glycyl tRNA Synthetase (GARS)ELISA kit	96 Test	38220090	24,500.00
CLS1042MO	Mouse Bone Morphogenetic Protein 1 (BMP1)ELISA kit	96 Test	38220090	24,500.00
CLS1043MO	Mouse Bone Morphogenetic Protein 10 (BMP10)ELISA kit	96 Test	38220090	24,500.00
CLS1044MO	Mouse Bone Morphogenetic Protein 15 (BMP15)ELISA kit	96 Test	38220090	24,500.00
CLS1045MO	Mouse Bone Morphogenetic Protein 2 (BMP2)ELISA kit	96 Test	38220090	24,500.00
CLS1046MO	Mouse Bone Morphogenetic Protein 4 (BMP4)ELISA kit	96 Test	38220090	24,500.00
CLS1047MO	Mouse Bone Morphogenetic Protein 5 (BMP5)ELISA kit	96 Test	38220090	24,500.00
CLS1048MO	Mouse Bone Morphogenetic Protein 8b (BMP8b)ELISA kit	96 Test	38220090	24,500.00
CLS1049MO	Mouse BMP Binding Endothelial Regulator (BMPER)ELISA kit	96 Test	38220090	24,500.00
CLS1050MO	Mouse Caspase 10 (CASP10)ELISA kit	96 Test	38220090	24,500.00
CLS1051MO	Mouse Caspase 11 (CASP11)ELISA kit	96 Test	38220090	24,500.00
CLS1052MO	Mouse Caspase 12 (CASP13)ELISA kit	96 Test	38220090	24,500.00
CLS1053MO	Mouse Caspase 13 (CASP13)ELISA kit	96 Test	38220090	24,500.00
CLS1054MO	Mouse Caspase 14 (CASP14)ELISA kit	96 Test	38220090	24,500.00
CLS1055MO	Mouse Caspase 2 (CASP2)ELISA kit	96 Test	38220090	24,500.00
CLS1056MO	Mouse Caspase 4 (CASP4)ELISA kit	96 Test	38220090	24,500.00
CLS1057MO	Mouse Caspase 5 (CASP5)ELISA kit	96 Test	38220090	24,500.00
CLS1058MO	Mouse Caspase 6 (CASP6)ELISA kit	96 Test	38220090	24,500.00
CLS1059MO	Mouse Caspase 7 (CASP7)ELISA kit	96 Test	38220090	24,500.00
CLS1060MO	Mouse Caspase 8 (CASP8)ELISA kit	96 Test	38220090	24,500.00
CLS1061MO	Mouse Erythropoietin Receptor (EPOR)ELISA kit	96 Test	38220090	24,500.00
CLS1062MO	Mouse Activated Protein C (APC)ELISA kit	96 Test	38220090	24,500.00
CLS1063MO	Mouse Myosin Light Chain 9, Regulatory (MYL9)ELISA kit	96 Test	38220090	24,500.00
CLS1064MO	Mouse Matrix Metalloproteinase 23A (MMP23A)ELISA kit	96 Test	38220090	24,500.00
CLS1065MO	Mouse Contactin 1 (CNTN1)ELISA kit	96 Test	38220090	24,500.00
CLS1066MO	Mouse Lecithin Cholesterol Acyltransferase (LCAT)ELISA kit	96 Test	38220090	24,500.00
CLS1067MO	Mouse Prothymosin Alpha (PTMa)ELISA kit	96 Test	38220090	24,500.00
CLS1068MO	Mouse Mercaptopyruvate Sulfurtransferase (MPST)ELISA kit	96 Test	38220090	24,500.00
CLS1069MO	Mouse Cartilage Associated Protein (CRTAP)ELISA kit	96 Test	38220090	24,500.00
CLS1070MO	Mouse Neuron Navigator 2 (NAV2)ELISA kit	96 Test	38220090	24,500.00
CLS1071MO	Mouse Growth Differentiation Factor 2 (GDF2)ELISA kit	96 Test	38220090	24,500.00
CLS1072MO	Mouse Growth Differentiation Factor 5 (GDF5)ELISA kit	96 Test	38220090	24,500.00
CLS1073MO	Mouse Carbonic Anhydrase II (CA2)ELISA kit	96 Test	38220090	24,500.00
CLS1074MO	Mouse Carbonic Anhydrase III, Muscle Specific (CA3)ELISA kit	96 Test	38220090	24,500.00
CLS1075MO	Mouse Carbonic Anhydrase IV (CA4)ELISA kit	96 Test	38220090	24,500.00
CLS1076MO	Mouse Carbonic Anhydrase VB, Mitochondrial (CA5B)ELISA kit	96 Test	38220090	24,500.00
CLS1077MO	Mouse Carbonic Anhydrase VI (CA6)ELISA kit	96 Test	38220090	24,500.00
CLS1078MO	Mouse Carbonic Anhydrase IX (CA9)ELISA kit	96 Test	38220090	24,500.00
CLS1079MO	Mouse Carbohydrate Antigen 15-3 (CA15-3)ELISA kit	96 Test	38220090	24,500.00
CLS1080MO	Mouse Carbohydrate Antigen 19-9 (CA19-9)ELISA kit	96 Test	38220090	24,500.00
CLS1081MO	Mouse Carbohydrate Antigen 242 (CA242)ELISA kit	96 Test	38220090	24,500.00
CLS1082MO	Mouse Cell Division Cycle Protein 23 (CDC23)ELISA kit	96 Test	38220090	24,500.00
CLS1083MO	Mouse Cytohesin Interacting Protein (CYTIP)ELISA kit	96 Test	38220090	24,500.00
CLS1084MO	Mouse Cytochrome P450 21B (CYP21B)ELISA kit	96 Test	38220090	24,500.00
CLS1085MO	Mouse Cyclin T (CCNT)ELISA kit	96 Test	38220090	24,500.00
CLS1086MO	Mouse Adenomatosis Polyposis Coli Protein (APC)ELISA kit	96 Test	38220090	24,500.00
CLS1087MO	Mouse Cardiotrophin 1 (CT1)ELISA kit	96 Test	38220090	24,500.00
CLS1088MO	Mouse Thymopoietin (TMPO)ELISA kit	96 Test	38220090	24,500.00

Cat.No.	Product Description	Pack Size	HSN	Unit Price
CLS1089MO	Mouse Hemoglobin (HB)ELISA kit	96 Test	38220090	24,500.00
CLS1090MO	Mouse Transgelin (TAGLN)ELISA kit	96 Test	38220090	24,500.00
CLS1091MO	Mouse Transgelin 2 (TAGLN2)ELISA kit	96 Test	38220090	24,500.00
CLS1092MO	Mouse Transgelin 3 (TAGLN3)ELISA kit	96 Test	38220090	24,500.00
CLS1093MO	Mouse Fibroblast Growth Factor 7 (FGF7)ELISA kit	96 Test	38220090	24,500.00
CLS1094MO	Mouse Anti-Oxidized Low Density Lipoprotein Antibody (OLAb)ELISA kit	96 Test	38220090	24,500.00
CLS1095MO	Mouse Low Density Lipoprotein Receptor Related Protein 8 (LRP8)ELISA kit	96 Test	38220090	24,500.00
CLS1096MO	Mouse Very Low Density Lipoprotein Receptor (VLDLR)ELISA kit	96 Test	38220090	24,500.00
CLS1097MO	Mouse Esophageal Cancer Related Gene 4 (ECRG4) Elisa Kit	96 Test	38220090	24,500.00
CLS1098MO	Mouse Stem Cell Factor Receptor,SCFR/CD117/C-kit ELISA kit	96 Test	38220090	24,500.00
CLS1099MO	Mouse Nuclear Mitotic Apparatus Protein 1,NUMA1 ELISA Kit	96 Test	38220090	24,500.00
CLS1100MO	Mouse Actin Alpha 1, Skeletal Muscle (ACTa1) ELISA Kit	96 Test	38220090	24,500.00
CLS1101MO	Mouse Keratin 2(KRT2)ELISA Kit	96 Test	38220090	24,500.00
CLS1102MO	Mouse non-neuronal enolase(NNE)ELISA Kit	96 Test	38220090	24,500.00
CLS1103MO	Mouse Centromere Protein H(CENPH)ELISA Kit	96 Test	38220090	24,500.00
CLS1104MO	Mouse Annexin A5 (ANXA5)ELISA Kit	96 Test	38220090	24,500.00
CLS1105MO	Mouse Matrix metalloproteinase 23B(MMP23B) ELISA kit	96 Test	38220090	24,500.00
CLS1106MO	Mouse Pepsinogen A (PGA) ELISA Kit	96 Test	38220090	24,500.00
CLS1107MO	Mouse Kallikrein 3/PSA(KLK3) Elisa kit	96 Test	38220090	24,500.00
CLS1108MO	Mouse Adiponectin Receptor 1 (ADIPOR1) ELISA Kit	96 Test	38220090	24,500.00
CLS1109MO	Mouse Connexin 43 (CX43)ELISA kit	96 Test	38220090	24,500.00
CLS1110MO	Mouse Galectin 14 (GAL14) ELISA kit	96 Test	38220090	24,500.00
CLS1111MO	Mouse Galectin 1 (GAL1) ELISA kit	96 Test	38220090	24,500.00
CLS1112MO	Mouse Galectin 9B (GAL9B) ELISA kit	96 Test	38220090	24,500.00
CLS1113MO	Mouse Galectin 7B (GAL7B) ELISA kit	96 Test	38220090	24,500.00
CLS1114MO	Mouse Galectin 8 (GAL8) ELISA kit	96 Test	38220090	24,500.00
CLS1115MO	Mouse Galectin 6 (GAL6) ELISA kit	96 Test	38220090	24,500.00
CLS1116MO	Mouse Galectin 4 (GAL4) ELISA kit	96 Test	38220090	24,500.00
CLS1117MO	Mouse Galectin 2 (GAL2) ELISA kit	96 Test	38220090	24,500.00
CLS1118MO	Mouse Galectin 12 (GAL12) ELISA kit	96 Test	38220090	24,500.00
CLS1119MO	Mouse Galectin 7 (GAL7) ELISA kit	96 Test	38220090	24,500.00
CLS1120MO	Mouse Macrophage Inflammatory Protein 1 Beta (MIP1b) ELISA Kit	96 Test	38220090	24,500.00
CLS1121MO	Mouse Insulin Like Growth Factor 2, Antisense (IGF2AS) ELISA kit	96 Test	38220090	24,500.00
CLS1122MO	Mouse Stress Induced Phosphoprotein 1 (STIP1)ELISA kit	96 Test	38220090	24,500.00
CLS1123MO	Mouse Alpha-Hemoglobin Stabilizing Protein (aHSP)ELISA kit	96 Test	38220090	24,500.00
CLS1124MO	Mouse Heat Shock 70kDa Protein 5 (HSPA5)ELISA kit	96 Test	38220090	24,500.00
CLS1125MO	Mouse Heat Shock 70kDa Protein 1 Like Protein (HSPA1L)ELISA kit	96 Test	38220090	24,500.00
CLS1126MO	Mouse Gliomedin (GLDN)ELISA kit	96 Test	38220090	24,500.00
CLS1127MO	Mouse Heat Shock 70kDa Protein 1B (HSPA1B)ELISA kit	96 Test	38220090	24,500.00
CLS1128MO	Mouse DnaJ/HSP40 Homolog Subfamily C, Member 12 (DNAJC12)ELISA kit	96 Test	38220090	24,500.00
CLS1129MO	Mouse Heat Shock 70kDa Protein 8 (HSPA8)ELISA kit	96 Test	38220090	24,500.00
CLS1130MO	Mouse Heat Shock Protein Beta 2 (HSPb2)ELISA kit	96 Test	38220090	24,500.00
CLS1131MO	Mouse Heat Shock Protein 90kDa Beta 1 (HSP90b1)ELISA kit	96 Test	38220090	24,500.00
CLS1132MO	Mouse Heat Shock Protein 47 (HSP47)ELISA kit	96 Test	38220090	24,500.00
CLS1133MO	Mouse Heat Shock 70kDa Protein 1A (HSPA1A)ELISA kit	96 Test	38220090	24,500.00

Cat.No.	Product Description	Pack Size	HSN	Unit Price
CLS1134MO	Mouse Heat Shock 70kDa Protein 4 (HSPA4)ELISA kit	96 Test	38220090	24,500.00
CLS1135MO	Mouse Heat Shock 70kDa Protein 9 (HSPA9)ELISA kit	96 Test	38220090	24,500.00
CLS1136MO	Mouse Heat Shock 10kDa Protein 1 (HSP10)ELISA kit	96 Test	38220090	24,500.00
CLS1137MO	Mouse Period Circadian Protein 1 (PER1)ELISA kit	96 Test	38220090	24,500.00
CLS1138MO	Mouse Methionine Adenosyltransferase I Alpha (MAT1a)	96 Test	38220090	24,500.00
CLS1139MO	Mouse Methionine Adenosyltransferase II Alpha (MAT2a)	96 Test	38220090	24,500.00
CLS1140MO	Mouse Claudin 1 (CLDN1)ELISA Kit	96 Test	38220090	24,500.00
CLS1141MO	Mouse Claudin 10 (CLDN10)ELISA Kit	96 Test	38220090	24,500.00
CLS1142MO	Mouse Claudin 12 (CLDN12)ELISA Kit	96 Test	38220090	24,500.00
CLS1143MO	Mouse Claudin 15 (CLDN15)ELISA Kit	96 Test	38220090	24,500.00
CLS1144MO	Mouse Claudin 17 (CLDN17)ELISA Kit	96 Test	38220090	24,500.00
CLS1145MO	Mouse Claudin 23 (CLDN23)ELISA Kit	96 Test	38220090	24,500.00
CLS1146MO	Mouse Surfactant Associated Protein J (SPJ)ELISA Kit	96 Test	38220090	24,500.00
CLS1147MO	Mouse Proprotein Convertase Subtilisin/Kexin Type 9 (PCSK9)ELISA Kit	96 Test	38220090	24,500.00
CLS1148MO	Mouse Furin (FUR)ELISA Kit	96 Test	38220090	24,500.00
CLS1149MO	Mouse Proprotein Convertase Subtilisin/Kexin Type 1 (PCSK1)ELISA Kit	96 Test	38220090	24,500.00
CLS1150MO	Mouse Proprotein Convertase Subtilisin/Kexin Type 5 (PCSK5)ELISA Kit	96 Test	38220090	24,500.00
CLS1151MO	Mouse Dual Specificity Phosphatase 1 (DUSP1)ELISA Kit	96 Test	38220090	24,500.00
CLS1152MO	Mouse Secreted Frizzled Related Protein 2 (SFRP2)ELISA Kit	96 Test	38220090	24,500.00
CLS1153MO	Mouse Secreted Frizzled Related Protein 1 (SFRP1)ELISA Kit	96 Test	38220090	24,500.00
CLS1154MO	Mouse Sex Determining Region Y Box Protein 9 (SOX9)ELISA Kit	96 Test	38220090	24,500.00
CLS1155MO	Mouse Sex Determining Region Y Box Protein 1 (SOX1)ELISA Kit	96 Test	38220090	24,500.00
CLS1156MO	Mouse Sex Determining Region Y Box Protein 2 (SOX2)ELISA Kit	96 Test	38220090	24,500.00
CLS1157MO	Mouse Sex Determining Region Y Box Protein 3 (SOX3)ELISA Kit	96 Test	38220090	24,500.00
CLS1158MO	Mouse Sex Determining Region Y Box Protein 18 (SOX18)ELISA Kit	96 Test	38220090	24,500.00
CLS1159MO	Mouse Plakophilin 4 (PKP4)ELISA Kit	96 Test	38220090	24,500.00
CLS1160MO	Mouse Plakophilin 3 (PKP3)ELISA Kit	96 Test	38220090	24,500.00
CLS1161MO	Mouse Plakophilin 2 (PKP2)ELISA Kit	96 Test	38220090	24,500.00
CLS1162MO	Mouse Plakophilin 1 (PKP1)ELISA Kit	96 Test	38220090	24,500.00
CLS1163MO	Mouse Ubiquitin Specific Peptidase 8 (USP8)ELISA Kit	96 Test	38220090	24,500.00
CLS1164MO	Mouse USP6 N-Terminal Like Protein (USP6NL)ELISA Kit	96 Test	38220090	24,500.00
CLS1165MO	Mouse Deubiquitinating Enzyme 3 (DUB3)ELISA Kit	96 Test	38220090	24,500.00
CLS1166MO	Mouse Proenkephalin (PENK)ELISA Kit	96 Test	38220090	24,500.00
CLS1167MO	Mouse Neuromedin B (NMB)ELISA Kit	96 Test	38220090	24,500.00
CLS1168MO	Mouse Ferritin Heavy Polypeptide (FTH)ELISA Kit	96 Test	38220090	24,500.00
CLS1169MO	Mouse Wiskott Aldrich Syndrome Protein (WASP)ELISA Kit	96 Test	38220090	24,500.00
CLS1170MO	Mouse Zinc Finger Homeobox Protein 3 (ZFX3)ELISA Kit	96 Test	38220090	24,500.00
CLS1171MO	Mouse Pyridoxal Kinase (PDXK)ELISA Kit	96 Test	38220090	24,500.00
CLS1172MO	Mouse aggrecan,Agc ELISA Kit	96 Test	38220090	24,500.00
CLS1173MO	Mouse Agouti Related Protein,AGRP ELISA Kit	96 Test	38220090	24,500.00
CLS1174MO	Mouse Agrin ELISA Kit	96 Test	38220090	24,500.00
CLS1175MO	Mouse alcohol dehydrogenase,ADH ELISA Kit	96 Test	38220090	24,500.00
CLS1176MO	Mouse aldehyde dehydrogenase,ALDH ELISA Kit	96 Test	38220090	24,500.00
CLS1177MO	Mouse Aldolase,ALD ELISA Kit	96 Test	38220090	24,500.00
CLS1178MO	Mouse Alpha1 Antichymotrypsin,AACT ELISA Kit	96 Test	38220090	24,500.00
CLS1179MO	Mouse alpha-1-microglobulin bikunin precursor,AMBIP ELISA Kit	96 Test	38220090	24,500.00

Cat.No.	Product Description	Pack Size	HSN	Unit Price
CLS1180MO	Mouse Alpha-Actin, α Actin ELISA Kit	96 Test	38220090	24,500.00
CLS1181MO	Mouse Carcinoembryonic Ferritin,CEF ELISA Kit	96 Test	38220090	24,500.00
CLS1182MO	Mouse cardiac ankyrin repeat domain 1,ANKRD1 ELISA Kit	96 Test	38220090	24,500.00
CLS1183MO	Mouse Cardiac myosin-light chains 1,CMLC-1 ELISA Kit	96 Test	38220090	24,500.00
CLS1184MO	Mouse Cartilage glycoprotein 39,HC gp-39 ELISA Kit	96 Test	38220090	24,500.00
CLS1185MO	Mouse caspase 4-apoptosis-related cysteine peptidase,Casp4 ELISA Kit	96 Test	38220090	24,500.00
CLS1186MO	Mouse caspase activated deoxyribonuclease,CAD ELISA Kit	96 Test	38220090	24,500.00
CLS1187MO	Mouse cathepsin antibody,cath-Ab ELISA Kit	96 Test	38220090	24,500.00
CLS1188MO	Mouse Cathepsin K,cath-K ELISA Kit	96 Test	38220090	24,500.00
CLS1189MO	Mouse Dickkopf 1,DKK1 ELISA Kit	96 Test	38220090	24,500.00
CLS1190MO	Mouse dihydropyrimidinase-like 2,DPYSL2 ELISA Kit	96 Test	38220090	24,500.00
CLS1191MO	Mouse dihydropyrimidinase-like 3,DPYSL3 ELISA Kit	96 Test	38220090	24,500.00
CLS1192MO	Mouse Dihydropyrimidine Dehydrogenase,DPYD ELISA Kit	96 Test	38220090	24,500.00
CLS1193MO	Mouse Noggin,NOG ELISA Kit	96 Test	38220090	24,500.00
CLS1194MO	Mouse cyclooxygenase-1,COX-1 ELISA Kit	96 Test	38220090	24,500.00
CLS1195MO	Mouse cyclooxygenase-receptor2,COX-2R ELISA Kit	96 Test	38220090	24,500.00
CLS1196MO	Mouse dermatan sulfate,DS ELISA Kit	96 Test	38220090	24,500.00
CLS1197MO	Mouse dermato-pontin,DPT ELISA Kit	96 Test	38220090	24,500.00
CLS1198MO	Mouse desmogleins 1,Dsg-1 ELISA Kit	96 Test	38220090	24,500.00
CLS1199MO	Mouse Guanine nucleotide exchange factor VAV3,VAV3 ELISA Kit	96 Test	38220090	24,500.00
CLS1200MO	Mouse cystathionine- γ -lyase,CSE ELISA Kit	96 Test	38220090	24,500.00
CLS1201MO	Mouse Cyclin-dependent kinase 17,CDK-17 ELISA Kit	96 Test	38220090	24,500.00
CLS1202MO	Mouse Cyclin-dependent kinase 2,CDK-2 ELISA Kit	96 Test	38220090	24,500.00
CLS1203MO	Mouse Cyclin-dependent kinase 7,CDK-7 ELISA Kit	96 Test	38220090	24,500.00
CLS1204MO	Mouse E-Cadherin,H-Cad/CDH13 ELISA Kit	96 Test	38220090	24,500.00
CLS1205MO	Mouse Elastin,ELN ELISA Kit	96 Test	38220090	24,500.00
CLS1206MO	Mouse Elastase ELISA Kit	96 Test	38220090	24,500.00
CLS1207MO	Mouse electron-transfer-flavoprotein beta polypeptide,ETFB ELISA Kit	96 Test	38220090	24,500.00
CLS1208MO	Mouse dopamine D2 receptor,D2R ELISA Kit	96 Test	38220090	24,500.00
CLS1209MO	Mouse dopamine- β -hydroxylase,DBH ELISA Kit	96 Test	38220090	24,500.00
CLS1210MO	Mouse dopamine decarboxylase,DDC ELISA Kit	96 Test	38220090	24,500.00
CLS1211MO	Mouse dopachrome tautomerase,DT ELISA Kit	96 Test	38220090	24,500.00
CLS1212MO	Mouse Dynamin 1,DNM1 ELISA kit	96 Test	38220090	24,500.00
CLS1213MO	Mouse dynamin 2,DNM2 ELISA Kit	96 Test	38220090	24,500.00
CLS1214MO	Mouse dystrophin ELISA Kit	96 Test	38220090	24,500.00
CLS1215MO	Mouse endomorphin-2,EM-2 ELISA Kit	96 Test	38220090	24,500.00
CLS1216MO	Mouse dynorphin,Dyn ELISA Kit	96 Test	38220090	24,500.00
CLS1217MO	Mouse elongin A,EloA ELISA Kit	96 Test	38220090	24,500.00
CLS1218MO	Mouse G protein-coupled receptor 109A,GPR109A ELISA Kit	96 Test	38220090	24,500.00
CLS1219MO	Mouse permeability glycoprotein,P-gp ELISA Kit	96 Test	38220090	24,500.00
CLS1220MO	Mouse TU3A Protein ELISA Kit	96 Test	38220090	24,500.00
CLS1221MO	Mouse T-Subset ELISA Kit	96 Test	38220090	24,500.00
CLS1222MO	Mouse Galectin-3 ELISA Kit	96 Test	38220090	24,500.00
CLS1223MO	Mouse Epiregulin,EPR ELISA Kit	96 Test	38220090	24,500.00
CLS1224MO	Mouse epidermal keratin,EK ELISA Kit	96 Test	38220090	24,500.00
CLS1225MO	Mouse epidermal Fatty acid binding protein,E-FABP ELISA Kit	96 Test	38220090	24,500.00
CLS1226MO	Mouse epiligrin,EP ELISA Kit	96 Test	38220090	24,500.00
CLS1227MO	Mouse forkhead box O3,FOXO3 ELISA Kit	96 Test	38220090	24,500.00
CLS1228MO	Mouse forkhead box O4,FOXO4 ELISA Kit	96 Test	38220090	24,500.00
CLS1229MO	Mouse farnesyl-diphosphate farnesyltransferase 1,FDFT1 ELISA Kit	96 Test	38220090	24,500.00

Cat.No.	Product Description	Pack Size	HSN	Unit Price
CLS1230MO	Mouse galanin,GAL ELISA Kit	96 Test	38220090	24,500.00
CLS1231MO	Mouse Fructose-1,6-bisphosphate aldolase,FDA ELISA Kit	96 Test	38220090	24,500.00
CLS1232MO	Mouse Fascin (FSCN)ELISA Kit	96 Test	38220090	24,500.00
CLS1233MO	Mouse frizzled homolog 8,FZD8 ELISA Kit	96 Test	38220090	24,500.00
CLS1234MO	Mouse epidermal basement membrane zone,EBMZ ELISA Kit	96 Test	38220090	24,500.00
CLS1235MO	Mouse granulocyte specific antinuclear antibody,GS-ANA ELISA Kit	96 Test	38220090	24,500.00
CLS1236MO	Mouse Fc region of immunoglobulin G,Fcy ELISA Kit	96 Test	38220090	24,500.00
CLS1237MO	Mouse Thrombin activatable fibrinolysis inhibitor,TAFI ELISA Kit	96 Test	38220090	24,500.00
CLS1238MO	Mouse thrombinthrombomodulin compound,T-TM ELISA Kit	96 Test	38220090	24,500.00
CLS1239MO	Mouse fetal sulfoslycoprotein antigen,FSA ELISA Kit	96 Test	38220090	24,500.00
CLS1240MO	Mouse tryptophanyl-tRNA synthetase,WARS ELISA Kit	96 Test	38220090	24,500.00
CLS1241MO	Mouse Epithelial membrane antigen,EMA ELISA Kit	96 Test	38220090	24,500.00
CLS1242MO	Mouse Epithelial Cell Adhesion Molecule,Ep-CAM ELISA Kit	96 Test	38220090	24,500.00
CLS1243MO	Mouse epidermal Fatty acid binding protein 5,eFABP5 ELISA kit	96 Test	38220090	24,500.00
CLS1244MO	Mouse Neuropilin-1(NRP1)ELISA kit	96 Test	38220090	24,500.00
CLS1245MO	Mouse growth-regulated oncogene 1,GRO-1 ELISA Kit	96 Test	38220090	24,500.00
CLS1246MO	Mouse growth-regulated oncogene α /melanoma growth stimulating activity,GRO α /MGSA ELISA Kit	96 Test	38220090	24,500.00
CLS1247MO	Mouse growth-regulated oncogene β /melanoma growth stimulating activity,GRO β /MGSA ELISA Kit	96 Test	38220090	24,500.00
CLS1248MO	Mouse Growth Hormone Binding Protein,GHBP ELISA Kit	96 Test	38220090	24,500.00
CLS1249MO	Mouse mitogen activated protein kinase1,MAPK1/MAPK ELISA Kit	96 Test	38220090	24,500.00
CLS1250MO	Mouse growth hormone relasing factor,GH-RF ELISA Kit	96 Test	38220090	24,500.00
CLS1251MO	Mouse growth-associated protein 43,GAP-43 ELISA Kit	96 Test	38220090	24,500.00
CLS1252MO	Mouse Peptidyl prolyl cis/trans isomerase,PPI ELISA Kit	96 Test	38220090	24,500.00
CLS1253MO	Mouse peptidyl-tRNA hydrolase,PTRH ELISA Kit	96 Test	38220090	24,500.00
CLS1254MO	Mouse peptidylprolyl isomerase(cyclophilin)-like 1,PP1L1 ELISA Kit	96 Test	38220090	24,500.00
CLS1255MO	Mouse gastric carcinoma Marker ELISA Kit	96 Test	38220090	24,500.00
CLS1256MO	Mouse DNA repair protein RAD51 homolog 1(RAD51) ELISA Kit	96 Test	38220090	24,500.00
CLS1257MO	Mouse Fibrin ELISA Kit	96 Test	38220090	24,500.00
CLS1258MO	Mouse Fibrinogen Degradation Product,FDP ELISA Kit	96 Test	38220090	24,500.00
CLS1259MO	Mouse Fibrinogen like peptide 2,fgl2 ELISA Kit	96 Test	38220090	24,500.00
CLS1260MO	Mouse Fibrinogen,Fbg ELISA Kit	96 Test	38220090	24,500.00
CLS1261MO	Mouse fibrinopeptide B,FPB ELISA Kit	96 Test	38220090	24,500.00
CLS1262MO	Mouse fumarase/fumarate hydratase,FUM ELISA Kit	96 Test	38220090	24,500.00
CLS1263MO	Mouse Trypsinogen-2,Try- II ELISA Kit	96 Test	38220090	24,500.00
CLS1264MO	Mouse free chorionic gonadotropin,f- β hCG ELISA KIT	96 Test	38220090	24,500.00
CLS1265MO	Mouse Free Protein S,FP-S ELISA Kit	96 Test	38220090	24,500.00
CLS1266MO	Mouse Apolipoprotein O,Apo-O ELISA Kit	96 Test	38220090	24,500.00
CLS1267MO	Mouse free haemoglobin,f-Hb ELISA Kit	96 Test	38220090	24,500.00
CLS1268MO	Mouse Free erythrocyte protoporphyrin,FEP ELISA Kit	96 Test	38220090	24,500.00
CLS1269MO	Mouse GRB10-interacting GYF protein 2(GIGYF2)ELISA kit	96 Test	38220090	24,500.00
CLS1270MO	Mouse Protein Tyrosine Phosphatase Non Receptor Type 11 (PTPN11)ELISA Kit	96 Test	38220090	24,500.00
CLS1271MO	Mouse Coronin 2A(CORO2A)ELISA Kit	96 Test	38220090	24,500.00
CLS1272MO	Mouse Coronin 2B(CORO2B)ELISA Kit	96 Test	38220090	24,500.00
CLS1273MO	Mouse Coronin 1B(CORO1B)ELISA Kit	96 Test	38220090	24,500.00
CLS1274MO	Mouse Coronin 1C(CORO1C)ELISA Kit	96 Test	38220090	24,500.00
CLS1275MO	Mouse Coronin 6(CORO6)ELISA Kit	96 Test	38220090	24,500.00

Cat.No.	Product Description	Pack Size	HSN	Unit Price
CLS1276MO	Mouse Coronin 7(CORO7)ELISA Kit	96 Test	38220090	24,500.00
CLS1277MO	Mouse Branched Chain Alpha-Ketoacid Dehydrogenase Kinase (BCKDK)ELISA Kit	96 Test	38220090	24,500.00
CLS1278MO	Mouse Growth Arrest And DNA Damage Inducible Protein Alpha (GADD45a)ELISA Kit	96 Test	38220090	24,500.00
CLS1279MO	Mouse Complement C1q tumor necrosis factor related protein 5,C1qtnf5/Ctrp5 ELISA Kit	96 Test	38220090	24,500.00
CLS1280MO	Mouse Vaccinia Related Kinase 1 (VRK1)ELISA Kit	96 Test	38220090	24,500.00
CLS1281MO	Mouse Bcl2/Adenovirus E1B 19kDa Interacting Protein 3 (BNIP3)ELISA Kit	96 Test	38220090	24,500.00
CLS1282MO	Mouse Carnitine Acylcarnitine Translocase (CACT)ELISA Kit	96 Test	38220090	24,500.00
CLS1283MO	Mouse Deiodinase Iodothyronine Type I (DIO1)ELISA Kit	96 Test	38220090	24,500.00
CLS1284MO	Mouse Deiodinase Iodothyronine Type III (DIO3)ELISA Kit	96 Test	38220090	24,500.00
CLS1285MO	Mouse Deiodinase Iodothyronine Type II (DIO2)ELISA Kit	96 Test	38220090	24,500.00
CLS1286MO	Mouse Cleavage And Polyadenylation Specific Factor 1 (CPSF1)ELISA Kit	96 Test	38220090	24,500.00
CLS1287MO	Mouse Potassium Intermediate Small Conductance Calcium Activated Channel Subfamily N, Member 2 (KCNN2)ELISA Kit	96 Test	38220090	24,500.00
CLS1288MO	Mouse CREB Regulated Transcription Coactivator 3 (CRTC3)ELISA Kit	96 Test	38220090	24,500.00
CLS1289MO	Mouse Coiled Coil Domain Containing Protein 80 (CCDC80)ELISA Kit	96 Test	38220090	24,500.00
CLS1290MO	Mouse Dynein Heavy Chain Domain Containing Protein 1 (DNHD1)ELISA Kit	96 Test	38220090	24,500.00
CLS1291MO	Mouse Girdin (GRDN)ELISA Kit	96 Test	38220090	24,500.00
CLS1292MO	Mouse Pseudouridylate Synthase 10 (PUS10)ELISA Kit	96 Test	38220090	24,500.00
CLS1293MO	Mouse Protein Tyrosine Phosphatase Type IVA 3 (PTP4A3)ELISA Kit	96 Test	38220090	24,500.00
CLS1294MO	Mouse Regenerating Islet Derived Protein 1 Alpha (REG1a)ELISA Kit	96 Test	38220090	24,500.00
CLS1295MO	Mouse Protein Tyrosine Phosphatase Receptor Type K (PTPRK)ELISA Kit	96 Test	38220090	24,500.00
CLS1296MO	Mouse Protein Tyrosine Phosphatase Receptor Type R (PTPRR)ELISA Kit	96 Test	38220090	24,500.00
CLS1297MO	Mouse Protein Tyrosine Phosphatase Receptor Type N (PTPRN)ELISA Kit	96 Test	38220090	24,500.00
CLS1298MO	Mouse Protein Tyrosine Phosphatase Receptor Type B (PTPRB)ELISA Kit	96 Test	38220090	24,500.00
CLS1299MO	Mouse Protein Tyrosine Phosphatase Receptor Type O (PTPRO)ELISA Kit	96 Test	38220090	24,500.00
CLS1300MO	Mouse Zinc Ribbon Domain Containing Protein 1 (ZNRD1)ELISA Kit	96 Test	38220090	24,500.00
CLS1301MO	Mouse T-Cell, Immune Regulator 1 (TCIRG1)ELISA Kit	96 Test	38220090	24,500.00
CLS1302MO	Mouse Growth Differentiation Factor 8 (GDF8)ELISA kit	96 Test	38220090	24,500.00
CLS1303MO	Mouse Growth Differentiation Factor 9 (GDF9)ELISA kit	96 Test	38220090	24,500.00
CLS1304MO	Mouse Myostatin,MSTN ELISA Kit	96 Test	38220090	24,500.00
CLS1305MO	Mouse Renalase(RNLS) ELISA Kit	96 Test	38220090	24,500.00
CLS1306MO	Mouse Dipeptidyl peptidase 3(DPP3) ELISA Kit	96 Test	38220090	24,500.00
CLS1307MO	Mouse Glypican-3,GPC-3 ELISA Kit	96 Test	38220090	24,500.00
CLS1308MO	Mouse Glypican 2 (GPC2)ELISA Kit	96 Test	38220090	24,500.00
CLS1309MO	Mouse Glypican 4 (GPC4)ELISA Kit	96 Test	38220090	24,500.00
CLS1310MO	Mouse Glypican-5,GPC-5 ELISA Kit	96 Test	38220090	24,500.00
CLS1311MO	Mouse Glypican-6,GPC-6 ELISA Kit	96 Test	38220090	24,500.00
CLS1312MO	Mouse Mucosae associated epithelia chemokine,MEC/CCL28 ELISA Kit	96 Test	38220090	24,500.00
CLS1313MO	Mouse Angiopoietin-like protein 2,ANGPTL2 ELISA Kit	96 Test	38220090	24,500.00
CLS1314MO	Mouse FMS-like tyrosine kinase 1,Flt1 ELISA Kit	96 Test	38220090	24,500.00

Cat.No.	Product Description	Pack Size	HSN	Unit Price
CLS1315MO	Mouse A disintegrin and metalloproteinase with thrombospondin motifs 1,ADAMTS1 ELISA kit	96 Test	38220090	24,500.00
CLS1316MO	Mouse Histone deacetylase 1,HDAC1 ELISA KIT	96 Test	38220090	24,500.00
CLS1317MO	Mouse Histone deacetylase 8,HDAC8 ELISA KIT	96 Test	38220090	24,500.00
CLS1318MO	Mouse Histone deacetylase 10,HDAC10 ELISA KIT	96 Test	38220090	24,500.00
CLS1319MO	Mouse Histone deacetylase 11,HDAC11 ELISA KIT	96 Test	38220090	24,500.00
CLS1320MO	Mouse Histone deacetylase complex subunit SAP30L(SAP30L) ELISA KIT	96 Test	38220090	24,500.00
CLS1321MO	Mouse α -galactosidase, α GAL ELISA Kit	96 Test	38220090	24,500.00
CLS1322MO	Mouse Follistatin-related protein 3(FSTL3)ELISA Kit	96 Test	38220090	24,500.00
CLS1323MO	Mouse Follistatin-related protein 4(FSTL4)ELISA Kit	96 Test	38220090	24,500.00
CLS1324MO	Mouse Follistatin-related protein 5(FSTL5)ELISA Kit	96 Test	38220090	24,500.00
CLS1325MO	Mouse Tomoregulin-1(TMEFF1)ELISA Kit	96 Test	38220090	24,500.00
CLS1326MO	Mouse Tomoregulin-2(TMEFF2)ELISA Kit	96 Test	38220090	24,500.00
CLS1327MO	Mouse Sclerostin(SOST)ELISA Kit	96 Test	38220090	24,500.00
CLS1328MO	Mouse Myelin-oligodendrocyte glycoprotein(MOG)ELISA Kit	96 Test	38220090	24,500.00
CLS1329MO	Mouse Hemoglobin subunit alpha(HBA)ELISA Kit	96 Test	38220090	24,500.00
CLS1330MO	Mouse Hemoglobin subunit beta-b1(HBB-b1) ELISA Kit	96 Test	38220090	24,500.00
CLS1331MO	Mouse Sclerostin domain-containing protein 1(SOSTDC1)ELISA Kit	96 Test	38220090	24,500.00
CLS1332MO	Mouse Islet amyloid polypeptide,IAPP ELISA Kit	96 Test	38220090	24,500.00
CLS1333MO	Mouse Platelet-derived growth factor subunit A,PDGFA ELISA kit	96 Test	38220090	24,500.00
CLS1334MO	Mouse Alpha-type platelet-derived growth factor receptor,PDGFRA ELISA kit	96 Test	38220090	24,500.00
CLS1335MO	Mouse Platelet-derived growth factor C,PDGF-C ELISA kit	96 Test	38220090	24,500.00
CLS1336MO	Mouse Ghrelin(GHRL) ELISA Kit	96 Test	38220090	24,500.00
CLS1337MO	Mouse Beclin1,BECN1 ELISA kit	96 Test	38220090	24,500.00
CLS1338MO	Mouse Carboxyhemoglobin,HbCO ELISA Kit	96 Test	38220090	24,500.00
CLS1339MO	Mouse Reactive oxygen species modulator 1(ROMO1)ELISA Kit	96 Test	38220090	24,500.00
CLS1340MO	Mouse Bactericidal permeability-increasing protein,BPI ELISA Kit	96 Test	38220090	24,500.00
CLS1341MO	Mouse Secretin(SCT) ELISA Kit	96 Test	38220090	24,500.00
CLS1342MO	Mouse secretin receptor,SR ELISA Kit	96 Test	38220090	24,500.00
CLS1343MO	Mouse Sperm-associated antigen 9(SPAG9) ELISA Kit	96 Test	38220090	24,500.00
CLS1344MO	Mouse G-protein coupled receptor 54(KISS-1 receptor) ELISA Kit	96 Test	38220090	24,500.00
CLS1345MO	Mouse Zinc finger E-box-binding homeobox 1 ,ZEB1 ELISA Kit	96 Test	38220090	24,500.00
CLS1346MO	Mouse Androgen receptor,AR ELISA Kit	96 Test	38220090	24,500.00
CLS1347MO	Mouse ELL-associated factor 2(EAF2) ELISA Kit	96 Test	38220090	24,500.00
CLS1348MO	Mouse sorbitol dehydrogenase,SDH ELISA Kit	96 Test	38220090	24,500.00
CLS1349MO	Mouse Cytochrome P450 19A1,CYP19A1 ELISA Kit	96 Test	38220090	24,500.00
CLS1350MO	Mouse Hypoxia-inducible factor 1-alpha inhibitor,HIF1AN ELISA Kit	96 Test	38220090	24,500.00
CLS1351MO	Mouse cytochrome P450 7A1,CYP7A1 ELISA Kit	96 Test	38220090	24,500.00
CLS1352MO	Mouse Steroid 17-alpha-hydroxylase/17,20 lyase,Cytochrome P450 17A1,CYP17A1 ELISA Kit	96 Test	38220090	24,500.00
CLS1353MO	Mouse Zinc finger HIT domain-containing protein 3(ZNHIT3) ELISA Kit	96 Test	38220090	24,500.00
CLS1354MO	Mouse Zinc finger matrin-type protein 3(ZMAT3)ELISA Kit	96 Test	38220090	24,500.00
CLS1355MO	Mouse Glucagon-like peptide 1 receptor (GLP1R) ELISA Kit	96 Test	38220090	24,500.00
CLS1356MO	Mouse Insulin receptor substrate 2,IRS-2 ELISA Kit	96 Test	38220090	24,500.00
CLS1357MO	Mouse Insulin receptor substrate 4,IRS-4 ELISA Kit	96 Test	38220090	24,500.00
CLS1358MO	Mouse Insulin receptor substrate 1,IRS-1 ELISA Kit	96 Test	38220090	24,500.00

Cat.No.	Product Description	Pack Size	HSN	Unit Price
CLS1359MO	Mouse Troponin T, slow skeletal muscle(TNNT1) ELISA Kit	96 Test	38220090	24,500.00
CLS1360MO	Mouse Troponin T, slow skeletal muscle(TNNT3) ELISA Kit	96 Test	38220090	24,500.00
CLS1361MO	Mouse Troponin I, fast skeletal muscle(TNNI2) ELISA Kit	96 Test	38220090	24,500.00
CLS1362MO	Mouse Neurofilament heavy polypeptide,NEFH ELISA Kit	96 Test	38220090	24,500.00
CLS1363MO	Mouse Thyroxine-Binding Globulin,TBG ELISA Kit	96 Test	38220090	24,500.00
CLS1364MO	Mouse Pancreatic Polypeptide,PP ELISA Kit	96 Test	38220090	24,500.00
CLS1365MO	Mouse proteolipid protein,PLP ELISA Kit	96 Test	38220090	24,500.00
CLS1366MO	Mouse parathyroid hormone-like protein,PLP ELISA Kit	96 Test	38220090	24,500.00
CLS1367MO	Mouse Interleukin 4 receptor,IL4R/CD124 ELISA Kit	96 Test	38220090	24,500.00
CLS1368MO	Mouse Interleukin 28B,IL-28B ELISA Kit	96 Test	38220090	24,500.00
CLS1369MO	Mouse Sialidase-1,NEU1 ELISA Kit	96 Test	38220090	24,500.00
CLS1370MO	Mouse Sialidase-2,NEU2 ELISA Kit	96 Test	38220090	24,500.00
CLS1371MO	Mouse Sialidase-3,NEU3 ELISA Kit	96 Test	38220090	24,500.00
CLS1372MO	Mouse Sialidase-4,NEU4 ELISA Kit	96 Test	38220090	24,500.00
CLS1373MO	Mouse high mobility group protein 17,HMG-17 ELISA Kit	96 Test	38220090	24,500.00
CLS1374MO	Mouse Interleukin 33,IL-33 ELISA Kit	96 Test	38220090	24,500.00
CLS1375MO	Mouse Vascular Endothelial cell Growth Factor A,VEGF-A ELISA KIT	96 Test	38220090	24,500.00
CLS1376MO	Mouse Interleukin 28A,IL-28A/IFN-λ2 ELISA Kit	96 Test	38220090	24,500.00
CLS1377MO	Mouse cutaneous T cell-attracting chemokine,CTACK ELISA Kit	96 Test	38220090	24,500.00
CLS1378MO	Mouse Breast and kidney expressed chemokine,BRAK ELISA Kit	96 Test	38220090	24,500.00
CLS1379MO	Mouse B-Lymphocyte Chemoattractant 1,BLC-1 ELISA Kit	96 Test	38220090	24,500.00
CLS1380MO	Mouse Leukotriene B4 receptor 1,LTB4R ELISA Kit	96 Test	38220090	24,500.00
CLS1381MO	Mouse Leukotriene B4 receptor 2,LTB4R2 ELISA Kit	96 Test	38220090	24,500.00
CLS1382MO	Mouse latent transforming growth factor beta binding protein 1,LTBP1 ELISA Kit	96 Test	38220090	24,500.00
CLS1383MO	Mouse latent transforming growth factor beta binding protein 3,LTBP3 ELISA Kit	96 Test	38220090	24,500.00
CLS1384MO	Mouse latent transforming growth factor beta binding protein 4,LTBP4 ELISA Kit	96 Test	38220090	24,500.00
CLS1385MO	Mouse Prostaglandin reductase 1,PTGR1 ELISA Kit	96 Test	38220090	24,500.00
CLS1386MO	Mouse Clathrin light chain B,CLTB ELISA Kit	96 Test	38220090	24,500.00
CLS1387MO	Mouse thymus expressed chemokine,TECK ELISA Kit	96 Test	38220090	24,500.00
CLS1388MO	Mouse Signal peptide, CUB and EGF-like domain-containing protein 1(SCUBE1) ELISA Kit	96 Test	38220090	24,500.00
CLS1389MO	Mouse ficolin 2,FCN2 ELISA Kit	96 Test	38220090	24,500.00
CLS1390MO	Mouse ficolin 1,FCN1 ELISA Kit	96 Test	38220090	24,500.00
CLS1391MO	Mouse secreted protein acidic and rich in cysteine,SPARC ELISA Kit	96 Test	38220090	24,500.00
CLS1392MO	Mouse Beta-defensin 3,DEFB3 ELISA kit	96 Test	38220090	24,500.00
CLS1393MO	Mouse Tumor necrosis factor receptor superfamily member 5,CD40/TNFRSF5 ELISA Kit	96 Test	38220090	24,500.00
CLS1394MO	Mouse Tumor necrosis factor ligand superfamily member 10,Tnfsf10/Trail ELISA Kit	96 Test	38220090	24,500.00
CLS1395MO	Mouse Ornithine decarboxylase,ODC1 ELISA Kit	96 Test	38220090	24,500.00
CLS1396MO	Mouse Dickkopf-4,DKK4 ELISA Kit	96 Test	38220090	24,500.00
CLS1397MO	Mouse Kremen protein 1(KREMEN1) ELISA Kit	96 Test	38220090	24,500.00
CLS1398MO	Mouse Dickkopf-like protein 1(DKKL1) ELISA Kit	96 Test	38220090	24,500.00
CLS1399MO	Mouse Endothelin-1 receptor,EDNRA ELISA Kit	96 Test	38220090	24,500.00
CLS1400MO	Mouse Hyaluronan synthase 3,HAS3 ELISA Kit	96 Test	38220090	24,500.00
CLS1401MO	Mouse Hyaluronan mediated motility receptor(HMMR) ELISA Kit	96 Test	38220090	24,500.00
CLS1402MO	Mouse Lymphatic vessel endothelial hyaluronic acid receptor 1(LYVE-1) ELISA Kit	96 Test	38220090	24,500.00
CLS1403MO	Mouse Protease Activated Receptor 2(PAR2) ELISA Kit	96 Test	38220090	24,500.00
CLS1404MO	Mouse Protease Activated Receptor 3(PAR3) ELISA Kit	96 Test	38220090	24,500.00

Cat.No.	Product Description	Pack Size	HSN	Unit Price
CLS1405MO	Mouse Protease Activated Receptor 4(PAR4) ELISA Kit	96 Test	38220090	24,500.00
CLS1406MO	Mouse Thymidine kinase, cytosolic(TK1) ELISA Kit	96 Test	38220090	24,500.00
CLS1407MO	Mouse Acetyl Coenzyme A,A-COA ELISA Kit	96 Test	38220090	24,500.00
CLS1408MO	Mouse Acetyl-Coa Carboxylase1(ACC1) ELISA Kit	96 Test	38220090	24,500.00
CLS1409MO	Mouse Atrial natriuretic peptide receptor 2,NPR2 ELISA kit	96 Test	38220090	24,500.00
CLS1410MO	Mouse Atrial natriuretic peptide receptor 1,NPR1 ELISA kit	96 Test	38220090	24,500.00
CLS1411MO	Mouse Atrial natriuretic peptide-converting enzyme,CORIN ELISA Kit	96 Test	38220090	24,500.00
CLS1412MO	Mouse Cytokine receptor-like factor 2,CRLF2 ELISA kit	96 Test	38220090	24,500.00
CLS1413MO	Mouse SPRY domain-containing SOCS box protein 1,SPSB1 ELISA kit	96 Test	38220090	24,500.00
CLS1414MO	Mouse SPRY domain-containing SOCS box protein 2,SPSB2 ELISA kit	96 Test	38220090	24,500.00
CLS1415MO	Mouse SPRY domain-containing SOCS box protein 3,SPSB3 ELISA kit	96 Test	38220090	24,500.00
CLS1416MO	Mouse SPRY domain-containing SOCS box protein 4,SPSB4 ELISA kit	96 Test	38220090	24,500.00
CLS1417MO	Mouse Non-histone chromosomal protein HMG-14,HMG14 ELISA kit	96 Test	38220090	24,500.00
CLS1418MO	Mouse Fructose-1,6-bisphosphatase 1,FBP1 ELISA kit	96 Test	38220090	24,500.00
CLS1419MO	Mouse Serum response factor-binding protein 1,SRFBP1 ELISA kit	96 Test	38220090	24,500.00
CLS1420MO	Mouse Pre-mRNA-processing factor 40 homolog A,PRPF40A ELISA kit	96 Test	38220090	24,500.00
CLS1421MO	Mouse Fibroblast growth factor-binding protein 1,FGFBP1 ELISA kit	96 Test	38220090	24,500.00
CLS1422MO	Mouse Polyamine-modulated factor 1-binding protein 1,PMFBP1 ELISA kit	96 Test	38220090	24,500.00
CLS1423MO	Mouse Formin-binding protein 1,FNBP1 ELISA kit	96 Test	38220090	24,500.00
CLS1424MO	Mouse Formin-binding protein 1-like,FNBP1L ELISA kit	96 Test	38220090	24,500.00
CLS1425MO	Mouse 6-phosphofructo-2-kinase/fructose-2,6-biphosphatase 1,PFKFB1 ELISA kit	96 Test	38220090	24,500.00
CLS1426MO	Mouse 6-phosphofructo-2-kinase/fructose-2,6-biphosphatase 2,PFKFB2 ELISA kit	96 Test	38220090	24,500.00
CLS1427MO	Mouse Collagen alpha-1(XVIII) chain,COL18A1 ELISA kit	96 Test	38220090	24,500.00
CLS1428MO	Mouse Glycogen synthase,GYS/GYS1 ELISA Kit	96 Test	38220090	24,500.00
CLS1429MO	Mouse Glycogen synthase kinase-3 alpha,Gsk3a ELISA Kit	96 Test	38220090	24,500.00
CLS1430MO	Mouse Glycogen synthase 2,GYS2 ELISA Kit	96 Test	38220090	24,500.00
CLS1431MO	Mouse Tubulin polymerization-promoting protein,TPPP ELISA Kit	96 Test	38220090	24,500.00
CLS1432MO	Mouse Tubulin polymerization-promoting protein family member 2,TPPP2 ELISA Kit	96 Test	38220090	24,500.00
CLS1433MO	Mouse Tubulin polymerization-promoting protein family member 3,TPPP3 ELISA Kit	96 Test	38220090	24,500.00
CLS1434MO	Mouse Ninein/GSK3B interacting protein,NIN ELISA Kit	96 Test	38220090	24,500.00
CLS1435MO	Mouse Serine/threonine-protein kinase Nek3,NEK3 ELISA Kit	96 Test	38220090	24,500.00
CLS1436MO	Mouse Pulmonary surfatcant-associated protein D,SP-D ELISA Kit	96 Test	38220090	24,500.00
CLS1437MO	Mouse Pulmonary surfatcant-associated protein C,SP-C ELISA Kit	96 Test	38220090	24,500.00
CLS1438MO	Mouse Transferrin receptor 2,TFR2 ELISA Kit	96 Test	38220090	24,500.00
CLS1439MO	Mouse 6-phosphofructokinase type C,PFKC ELISA Kit	96 Test	38220090	24,500.00
CLS1440MO	Mouse polymeric immunoglobulin receptor/secretory component,PIGR/SC ELISA Kit	96 Test	38220090	24,500.00
CLS1441MO	Mouse Transcription factor 4,TCF-4 ELISA Kit	96 Test	38220090	24,500.00
CLS1442MO	Mouse Receptor I for the Fc region of immunoglobulin G,FcγR I ELISA Kit	96 Test	38220090	24,500.00

Cat.No.	Product Description	Pack Size	HSN	Unit Price
CLS1443MO	Mouse T-lymphocyte activation antigen CD86,CD86 ELISA Kit	96 Test	38220090	24,500.00
CLS1444MO	Mouse Protein tyrosine phosphatase receptor type A,PTPRA ELISA Kit	96 Test	38220090	24,500.00
CLS1445MO	Mouse leukocyte common antigen,LCA/CD45 ELISA Kit	96 Test	38220090	24,500.00
CLS1446MO	Mouse Protein Tyrosine Phosphatase Receptor Type S (PTPRS)ELISA Kit	96 Test	38220090	24,500.00
CLS1447MO	Mouse Protein Tyrosine Phosphatase Receptor Type T (PTPRT)ELISA kit	96 Test	38220090	24,500.00
CLS1448MO	Mouse Protein Tyrosine Phosphatase Receptor Type T,PTPRT/LAR ELISA Kit	96 Test	38220090	24,500.00
CLS1449MO	Mouse Protein Tyrosine Phosphatase Receptor Type J (PTPRJ)ELISA Kit	96 Test	38220090	24,500.00
CLS1450MO	Mouse Glutamate [NMDA] receptor subunit zeta-1,GRIN1 ELISA Kit	96 Test	38220090	24,500.00
CLS1451MO	Mouse Endothelin 2,ET-2 ELISA Kit	96 Test	38220090	24,500.00
CLS1452MO	Mouse Endothelin 3,ET-3 ELISA Kit	96 Test	38220090	24,500.00
CLS1453MO	Mouse Fibronectin type III domain-containing protein 5,FNDC5/FRCP2 ELISA Kit	96 Test	38220090	24,500.00
CLS1454MO	Mouse Endothelin-converting enzyme 1,ECE1 ELISA Kit	96 Test	38220090	24,500.00
CLS1455MO	Mouse soluble amyloid precursor protein β ,sAPP β ELISA Kit	96 Test	38220090	24,500.00
CLS1456MO	Mouse Tripartite motif-containing protein 21,TRIM21/RNF81 ELISA Kit	96 Test	38220090	24,500.00
CLS1457MO	Mouse Breast cancer susceptibility protein 1,BRCA-1 ELISA Kit	96 Test	38220090	24,500.00
CLS1458MO	Mouse Breast cancer susceptibility protein 2,BRCA-2 ELISA Kit	96 Test	38220090	24,500.00
CLS1459MO	Mouse Lys-63-specific deubiquitinase BRCC36,BRCC3/BRCC36 ELISA Kit	96 Test	38220090	24,500.00
CLS1460MO	Mouse Myo-inositol oxygenase,MIOX ELISA Kit	96 Test	38220090	24,500.00
CLS1461MO	Mouse Gonadotropin-releasing hormone receptor,GnRHR ELISA Kit	96 Test	38220090	24,500.00
CLS1462MO	Mouse Kallikrein 8,KLK8 ELISA Kit	96 Test	38220090	24,500.00
CLS1463MO	Mouse Kallikrein 7,KLK7 ELISA Kit	96 Test	38220090	24,500.00
CLS1464MO	Mouse A Disintegrin And Metalloprotease 33,ADAM33 ELISA Kit	96 Test	38220090	24,500.00
CLS1465MO	Mouse Protein jagged-1,JAG1/CD339 ELISA Kit	96 Test	38220090	24,500.00
CLS1466MO	Mouse Protein jagged-2,JAG2 ELISA Kit	96 Test	38220090	24,500.00
CLS1467MO	Mouse Neurogenic locus notch homolog protein 1,NOTCH1 ELISA Kit	96 Test	38220090	24,500.00
CLS1468MO	Mouse Collagen type I alpha 2,COL1A2/Collagen I ELISA Kit	96 Test	38220090	24,500.00
CLS1469MO	Mouse Collagen alpha-1(IV) chain,COL4A1/Collagen IV ELISA Kit	96 Test	38220090	24,500.00
CLS1470MO	Mouse Phosphatidylinositol N- acetylglucosaminyltransferase subunit Y,PIGY ELISA Kit	96 Test	38220090	24,500.00
CLS1471MO	Mouse Retina-specific copper amine oxidase,AOC2 ELISA Kit	96 Test	38220090	24,500.00
CLS1472MO	Mouse Zinc finger CCCH domain-containing protein 15,ZC3H15 ELISA Kit	96 Test	38220090	24,500.00
CLS1473MO	Mouse Urocortin,UCN LISA Kit	96 Test	38220090	24,500.00
CLS1474MO	Mouse Urocortin-2,UCN2/SRP LISA Kit	96 Test	38220090	24,500.00
CLS1475MO	Mouse Urocortin-3,UCN3/SPC LISA Kit	96 Test	38220090	24,500.00
CLS1476MO	Mouse Apelin receptor,APLNR ELISA Kit	96 Test	38220090	24,500.00
CLS1477MO	Mouse Potassium channel subfamily K member 1,KCNK1 ELISA Kit	96 Test	38220090	24,500.00

Cat.No.	Product Description	Pack Size	HSN	Unit Price
CLS1478MO	Mouse Potassium channel subfamily K member 2,KCNK2 ELISA Kit	96 Test	38220090	24,500.00
CLS1479MO	Mouse Potassium channel subfamily K member 3,KCNK3 ELISA Kit	96 Test	38220090	24,500.00
CLS1480MO	Mouse Potassium channel subfamily K member 4,KCNK4 ELISA Kit	96 Test	38220090	24,500.00
CLS1481MO	Mouse Potassium channel subfamily K member 7,KCNK7 ELISA Kit	96 Test	38220090	24,500.00
CLS1482MO	Mouse Potassium channel subfamily K member 9,KCNK9 ELISA Kit	96 Test	38220090	24,500.00
CLS1483MO	Mouse Potassium channel subfamily K member 13,KCNK13 ELISA Kit	96 Test	38220090	24,500.00
CLS1484MO	Mouse Potassium channel subfamily K member 18,KCNK18 ELISA Kit	96 Test	38220090	24,500.00
CLS1485MO	Mouse Vitamin D-binding protein,DBP ELISA Kit	96 Test	38220090	24,500.00
CLS1486MO	Mouse ATP-sensitive inward rectifier potassium channel 1,KCNJ1/ROM-K ELISA Kit	96 Test	38220090	24,500.00
CLS1487MO	Mouse ATP-sensitive inward rectifier potassium channel 10,KCNJ10/Kir4.1 ELISA Kit	96 Test	38220090	24,500.00
CLS1488MO	Mouse ATP-sensitive inward rectifier potassium channel 11,KCNJ11/Kir6.2 ELISA Kit	96 Test	38220090	24,500.00
CLS1489MO	Mouse ATP-sensitive inward rectifier potassium channel 12,KCNJ12/Kir2.2 ELISA Kit	96 Test	38220090	24,500.00
CLS1490MO	Mouse Inward rectifier potassium channel 13,KCNJ13 ELISA Kit	96 Test	38220090	24,500.00
CLS1491MO	Mouse ATP-sensitive inward rectifier potassium channel 14,KCNJ14/Kir2.4 ELISA Kit	96 Test	38220090	24,500.00
CLS1492MO	Mouse ATP-sensitive inward rectifier potassium channel 15,KCNJ15/Kir4.2 ELISA Kit	96 Test	38220090	24,500.00
CLS1493MO	Mouse Inward rectifier potassium channel 16,KCNJ16 ELISA Kit	96 Test	38220090	24,500.00
CLS1494MO	Mouse Inward rectifier potassium channel 2,KCNJ2 ELISA Kit	96 Test	38220090	24,500.00
CLS1495MO	Mouse G protein-activated inward rectifier potassium channel 1,KCNJ3/GIRK1 ELISA Kit	96 Test	38220090	24,500.00
CLS1496MO	Mouse Inward rectifier potassium channel 4,KCNJ4 ELISA Kit	96 Test	38220090	24,500.00
CLS1497MO	Mouse G protein-activated inward rectifier potassium channel 4,KCNJ5/GIRK4 ELISA Kit	96 Test	38220090	24,500.00
CLS1498MO	Mouse G protein-activated inward rectifier potassium channel 2,KCNJ6/GIRK2 ELISA Kit	96 Test	38220090	24,500.00
CLS1499MO	Mouse ATP-sensitive inward rectifier potassium channel 8,KCNJ8/Kir6.1 ELISA Kit	96 Test	38220090	24,500.00
CLS1500MO	Mouse G protein-activated inward rectifier potassium channel 3,KCNJ9/GIRK3 ELISA Kit	96 Test	38220090	24,500.00
CLS1501MO	Mouse Bruton tyrosine kinase,Btk ELISA Kit	96 Test	38220090	24,500.00
CLS1502MO	Mouse Deoxyribonuclease 1,DNase-1 ELISA Kit	96 Test	38220090	24,500.00
CLS1503MO	Mouse Deoxyribonuclease-2-alpha,DNASE2A ELISA Kit	96 Test	38220090	24,500.00
CLS1504MO	Mouse Deoxyribonuclease-2-beta,DNASE2B ELISA Kit	96 Test	38220090	24,500.00
CLS1505MO	Mouse Deoxyribonuclease-1-like 1,DNASE1L1 ELISA Kit	96 Test	38220090	24,500.00
CLS1506MO	Mouse Cytochrome P450 1A1 (CYP1A1)ELISA kit	96 Test	38220090	24,500.00
CLS1507MO	Mouse Isocitrate dehydrogenase [NADP] mitochondrial(IDH2) ELISA Kit	96 Test	38220090	24,500.00
CLS1508MO	Mouse Perilipin-1(PLIN1)ELISA kit	96 Test	38220090	24,500.00
CLS1509MO	Mouse Perilipin-2(PLIN2)ELISA kit	96 Test	38220090	24,500.00
CLS1510MO	Mouse Oxidized low-density lipoprotein receptor 1,OLR1/LOX1 ELISA kit	96 Test	38220090	24,500.00

Cat.No.	Product Description	Pack Size	HSN	Unit Price
CLS1511MO	Mouse Periostin,POSTN ELISA kit	96 Test	38220090	24,500.00
CLS1512MO	Mouse CXC-chemokine receptor 4,CXCR4 ELISA Kit	96 Test	38220090	24,500.00
CLS1513MO	Mouse matrix metalloproteinase 12,MMP-12 ELISA kit	96 Test	38220090	24,500.00
CLS1514MO	Mouse glutathione S-transferases,GSTs ELISA Kit	96 Test	38220090	24,500.00
CLS1515MO	Mouse Lysyl oxidase-like protein 1,LOXL1 ELISA kit	96 Test	38220090	24,500.00
CLS1516MO	Mouse Mesencephalic astrocyte-derived neurotrophic factor,MANF ELISA Kit	96 Test	38220090	24,500.00
CLS1517MO	Mouse Fructosamine,FTA ELISA kit	96 Test	38220090	24,500.00
CLS1518MO	Mouse Fructosamine-3-kinase,FN3K ELISA kit	96 Test	38220090	24,500.00
CLS1519MO	Mouse Rho Guanine Nucleotide Exchange Factor 1(ARHGEF1)ELISA Kit	96 Test	38220090	24,500.00
CLS1520MO	Mouse Rho Guanine Nucleotide Exchange Factor 2(ARHGEF2)ELISA Kit	96 Test	38220090	24,500.00
CLS1521MO	Mouse Rho Guanine Nucleotide Exchange Factor 3(ARHGEF3)ELISA Kit	96 Test	38220090	24,500.00
CLS1522MO	Mouse Rho Guanine Nucleotide Exchange Factor 4(ARHGEF4)ELISA Kit	96 Test	38220090	24,500.00
CLS1523MO	Mouse Rho Guanine Nucleotide Exchange Factor 6(ARHGEF6)ELISA Kit	96 Test	38220090	24,500.00
CLS1524MO	Mouse Rho Guanine Nucleotide Exchange Factor 7(ARHGEF7)ELISA Kit	96 Test	38220090	24,500.00
CLS1525MO	Mouse GRB2-related adapter protein 2(GRAP2/P38) ELISA Kit	96 Test	38220090	24,500.00
CLS1526MO	Mouse Cyclic AMP-dependent transcription factor ATF-2,ATF2 ELISA kit	96 Test	38220090	24,500.00
CLS1527MO	Mouse Phosphatidylinositol-3,4,5-trisphosphate 3- phosphatase and dual-specificity protein phosphatase PTEN,PTEN ELISA kit	96 Test	38220090	24,500.00
CLS1528MO	Mouse Cyclin-dependent kinase inhibitor 1,CDKN1A/P21 ELISA kit	96 Test	38220090	24,500.00
CLS1529MO	Mouse Hemopexin,HPX ELISA kit	96 Test	38220090	24,500.00
CLS1530MO	Mouse Selenide, water dikinase 2,SEPHS2 ELISA kit	96 Test	38220090	24,500.00
CLS1531MO	Mouse Selenium-binding protein 1,SELENBP1 ELISA kit	96 Test	38220090	24,500.00
CLS1532MO	Mouse Glucose transporter 1,GLUT1/SLC2A1 ELISA Kit	96 Test	38220090	24,500.00
CLS1533MO	Mouse mitogen activated protein kinase3,MAPK3/PRKM3 ELISA Kit	96 Test	38220090	24,500.00
CLS1534MO	Mouse Calpastatin/Calpain inhibitor,CAST ELISA Kit	96 Test	38220090	24,500.00
CLS1535MO	Mouse glucokinase regulatory protein,GKRP ELISA Kit	96 Test	38220090	24,500.00
CLS1536MO	Mouse Glucose-6-phosphate isomerase,GPI ELISA Kit	96 Test	38220090	24,500.00
CLS1537MO	Mouse Tumour necrosis factor related weak inducer of apoptosis,TWEAK ELISA Kit	96 Test	38220090	24,500.00
CLS1538MO	Mouse DNA-dependent protein kinase catalytic subunit,PRKDC ELISA Kit	96 Test	38220090	24,500.00
CLS1539MO	Mouse Fibroblast growth factor 6,FGF6 ELISA Kit	96 Test	38220090	24,500.00
CLS1540MO	Mouse Interleukin 31,IL-31 ELISA Kit	96 Test	38220090	24,500.00
CLS1541MO	Mouse Regenerating islet-derived protein 3-alpha,REG-3-alpha ELISA Kit	96 Test	38220090	24,500.00
CLS1542MO	Mouse Growth arrest-specific protein 6,GAS6 ELISA Kit	96 Test	38220090	24,500.00
CLS1543MO	Mouse Melanotransferrin (MFI2)ELISA Kit	96 Test	38220090	24,500.00
CLS1544MO	Mouse Myelin associated glycoprotein,MAG ELISA Kit	96 Test	38220090	24,500.00
CLS1545MO	Mouse Retinal dehydrogenase 1,ALDH1A1 ELISA Kit	96 Test	38220090	24,500.00
CLS1546MO	Mouse Delta Like Protein 1(DLL1)ELISA Kit	96 Test	38220090	24,500.00
CLS1547MO	Mouse Delta Like Protein 3(DLL3)ELISA Kit	96 Test	38220090	24,500.00
CLS1548MO	Mouse Neurogenic locus notch homolog protein 2,NOTCH2 ELISA Kit	96 Test	38220090	24,500.00
CLS1549MO	Mouse Neurogenic locus notch homolog protein 3,NOTCH3 ELISA Kit	96 Test	38220090	24,500.00
CLS1550MO	Mouse Neurogenic locus notch homolog protein 4,NOTCH4 ELISA Kit	96 Test	38220090	24,500.00
CLS1551MO	Mouse Synuclein-gamma,SNCG ELISA Kit	96 Test	38220090	24,500.00

Cat.No.	Product Description	Pack Size	HSN	Unit Price
CLS1552MO	Mouse Acetyl Coenzyme A carboxylase alpha,ACACA ELISA Kit	96 Test	38220090	24,500.00
CLS1553MO	Mouse Tyrosine-protein kinase receptor UFO,AXL/UFO ELISA Kit	96 Test	38220090	24,500.00
CLS1554MO	Mouse Cadherin 11 (CDH11/CAD11)ELISA Kit	96 Test	38220090	24,500.00
CLS1555MO	Mouse Transferrin(TRF)ELISA Kit	96 Test	38220090	24,500.00
CLS1556MO	Mouse Alpha-Synuclein,SNCA ELISA Kit	96 Test	38220090	24,500.00
CLS1557MO	Mouse Complement factor D/Adipsin,CFD ELISA Kit	96 Test	38220090	24,500.00
CLS1558MO	Mouse Fibrinogen-like protein 1,FGL1 ELISA Kit	96 Test	38220090	24,500.00
CLS1559MO	Mouse Transglutaminase-3,TGM3 ELISA Kit	96 Test	38220090	24,500.00
CLS1560MO	Mouse Alpha-1B-glycoprotein,A1BG ELISA Kit	96 Test	38220090	24,500.00
CLS1561MO	Mouse CD5 antigen-like,CD5L ELISA Kit	96 Test	38220090	24,500.00
CLS1562MO	Mouse vitronectin,VNR ELISA Kit	96 Test	38220090	24,500.00
CLS1563MO	Mouse Fetuin B,FETU-B ELISA Kit	96 Test	38220090	24,500.00
CLS1564MO	Mouse Muscle-specific RING finger protein 1,MuRF1 ELISA Kit	96 Test	38220090	24,500.00
CLS1565MO	Mouse Estrogen Receptor beta,ER-beta ELISA Kit	96 Test	38220090	24,500.00
CLS1566MO	Mouse Pancreatic triacylglycerol lipase,PNLIP ELISA Kit	96 Test	38220090	24,500.00
CLS1567MO	Mouse Annexin A1 (ANXA1)ELISA Kit	96 Test	38220090	24,500.00
CLS1568MO	Mouse Annexin A3 (ANXA3)ELISA Kit	96 Test	38220090	24,500.00
CLS1569MO	Mouse Annexin A6 (ANXA6)ELISA Kit	96 Test	38220090	24,500.00
CLS1570MO	Mouse Annexin A4 (ANXA4)ELISA Kit	96 Test	38220090	24,500.00
CLS1571MO	Mouse Asymmetrical dimethylarginine,ADMA ELISA Kit	96 Test	38220090	24,500.00
CLS1572MO	Mouse F-box only protein 32,FBXO32/MAFbx ELISA Kit	96 Test	38220090	24,500.00
CLS1573MO	Mouse Telomerase reverse transcriptase,TERT ELISA Kit	96 Test	38220090	24,500.00
CLS1574MO	Mouse Homeobox protein Nkx-2.1,NKX2-1 ELISA Kit	96 Test	38220090	24,500.00
CLS1575MO	Mouse Placenta-specific protein 1,PLAC1 ELISA Kit	96 Test	38220090	24,500.00
CLS1576MO	Mouse Fibrillin-1,FBN1 ELISA Kit	96 Test	38220090	24,500.00
CLS1577MO	Mouse TGF-beta receptor type-1,TGFB1 ELISA Kit	96 Test	38220090	24,500.00
CLS1578MO	Mouse Transcription factor GATA-5,GATA5 ELISA Kit	96 Test	38220090	24,500.00
CLS1579MO	Mouse Kininogen-1,KNG1/HMWK ELISA Kit	96 Test	38220090	24,500.00
CLS1580MO	Mouse 1,25-dihydroxyvitamin D(3) 24-hydroxylase,CYP24A1 ELISA Kit	96 Test	38220090	24,500.00
CLS1581MO	Mouse Nestin(NES) ELISA Kit	96 Test	38220090	24,500.00
CLS1582MO	Mouse Neuromedin U (NMU)ELISA kit	96 Test	38220090	24,500.00
CLS1583MO	Mouse 8-iso prostaglandin F2α,8-iso-PGF2a ELISA Kit	96 Test	38220090	24,500.00
CLS1584MO	Mouse Catechol-O-Methyltransferase(COMT)ELISA Kit	96 Test	38220090	24,500.00
CLS0001GP	Guinea pig Glucagon-like peptide 1,GLP-1 ELISA Kit	96 Test	38220090	24,500.00
CLS0002GP	Guinea pig Insulin,INS ELISA Kit	96 Test	38220090	24,500.00
CLS0003GP	Guinea pig interleukin10(IL-10) ELISA Kit	96 Test	38220090	24,500.00
CLS0004GP	Guinea Pig Interleukin 1β,IL-1β ELISA Kit	96 Test	38220090	24,500.00
CLS0005GP	Guinea pig Interleukin 8,IL-8 ELISA Kit	96 Test	38220090	24,500.00
CLS0006GP	Guinea pig Tumor necrosis factor α,TNF-α ELISA Kit	96 Test	38220090	24,500.00
CLS0007GP	Guinea pig 3-Nitrotyrosine(3-NT)ELISA Kit	96 Test	38220090	24,500.00
CLS0008GP	Guinea pig Nucleoporin 153kDa(NUP153)ELISA Kit	96 Test	38220090	24,500.00
CLS0009GP	Guinea pig Protein Carbonyl(PC)ELISA Kit	96 Test	38220090	24,500.00
CLS0010GP	Guinea pig Glutathione(GSH)ELISA Kit	96 Test	38220090	24,500.00
CLS0011GP	Guinea pig Glutathione peroxidase(GSH-Px)ELISA Kit	96 Test	38220090	24,500.00
CLS0012GP	Guinea pig Malondialdehyde (MDA)ELISA Kit	96 Test	38220090	24,500.00
CLS0013GP	Guinea pig cyclooxygenase-2(COX-2)ELISA Kit	96 Test	38220090	24,500.00
CLS0014GP	Guinea pig cyclooxygenase-1(COX-1)ELISA Kit	96 Test	38220090	24,500.00
CLS0015GP	Guinea pig Lipoxxygenase-12(LOX-12)ELISA Kit	96 Test	38220090	24,500.00
CLS0016GP	Guinea pig visfatin ELISA Kit	96 Test	38220090	24,500.00
CLS0017GP	Guinea Pig Substance P,SP ELISA	96 Test	38220090	24,500.00
CLS0018GP	Guinea pig transforming growth factor β1,TGF-β1 ELISA Kit	96 Test	38220090	24,500.00
CLS0019GP	Guinea Pig calcitonin gene related peptide,CGRP ELISA Kit	96 Test	38220090	24,500.00
CLS0020GP	Guinea pig Interferon γ ,IFN-γ ELISA Kit	96 Test	38220090	24,500.00

Cat.No.	Product Description	Pack Size	HSN	Unit Price
CLS0021GP	Guinea pig interleukin 4,IL-4 ELISA Kit	96 Test	38220090	24,500.00
CLS0022GP	Guinea pig ovalbumin specific IgG,OVA sIgG ELISA Kit	96 Test	38220090	24,500.00
CLS0023GP	Guinea pig ovalbumin specific IgE,OVA sIgE ELISA Kit	96 Test	38220090	24,500.00
CLS0024GP	Guinea pig cartilage oligomeric matrix protein,COMP ELISA KIT	96 Test	38220090	24,500.00
CLS0025GP	Guinea pig heparin sulphate protoglycans,HSPG ELISA Kit	96 Test	38220090	24,500.00
CLS0026GP	Guinea pig Collagen Type II,Col II ELISA Kit	96 Test	38220090	24,500.00
CLS0027GP	Guinea pig monocyte chemotactic protein 1(MCP-1)ELISA Kit	96 Test	38220090	24,500.00
CLS0028GP	Guinea pig adiponectin,ADP ELISA Kit	96 Test	38220090	24,500.00
CLS0029GP	Guinea pig D-Dimer (D2D)ELISA Kit	96 Test	38220090	24,500.00
CLS0030GP	Guinea pig Endothelin 1,ET-1 ELISA Kit	96 Test	38220090	24,500.00
CLS0031GP	Guinea pig Histamine,HIS ELISA Kit	96 Test	38220090	24,500.00
CLS0032GP	Guinea pig Immunoglobulin E,IgE ELISA Kit	96 Test	38220090	24,500.00
CLS0033GP	Guinea pig interleukin 2,IL-2 ELISA Kit	96 Test	38220090	24,500.00
CLS0034GP	Guinea pig Interleukin 6,IL-6 ELISA Kit	96 Test	38220090	24,500.00
CLS0035GP	Guinea pig Leukotriene B4,LT-B4 ELISA Kit	96 Test	38220090	24,500.00
CLS0036GP	Guinea pig Anti-filaggrin antibody,AFA ELISA KIT	96 Test	38220090	24,500.00
CLS0037GP	Guinea pig Collagen Type I ,Col I ELISA Kit	96 Test	38220090	24,500.00
CLS0038GP	Guinea pig Collagen Type IV,Col IV ELISA Kit	96 Test	38220090	24,500.00
CLS0039GP	Guinea pig Hemoglobin subunit beta(HBB) ELISA Kit	96 Test	38220090	24,500.00
CLS0040GP	Guinea pig Hyaluronic acid,HA ELISA Kit	96 Test	38220090	24,500.00
CLS0041GP	Guinea pig Immunoglobulin G1,IgG1 ELISA kit	96 Test	38220090	24,500.00
CLS0042GP	Guinea Pig lipid peroxide,LPO ELISA Kit	96 Test	38220090	24,500.00
CLS0043GP	Guinea pig phosphorylated epidermal growth factor receptor,p-EGFR ELISA Kit	96 Test	38220090	24,500.00
CLS0044GP	Guinea pig Transforming Growth Factor beta 2(TGF-β2)ELISA Kit	96 Test	38220090	24,500.00
CLS0045GP	Guinea pig transforming growth factor β3,TGF-β3 ELISA Kit	96 Test	38220090	24,500.00
CLS0046GP	Guinea Pig advanced glycation end products,AGEs ELISA Kit	96 Test	38220090	24,500.00
CLS0047GP	Guinea pig Aldolase A, Fructose Bisphosphate (ALDOA)ELISA Kit	96 Test	38220090	24,500.00
CLS0048GP	Guinea pig Antithrombin (AT)ELISA Kit	96 Test	38220090	24,500.00
CLS0049GP	Guinea pig Ataxia Telangiectasia Mutated (ATM)ELISA Kit	96 Test	38220090	24,500.00
CLS0050GP	Guinea pig Bruton'S Tyrosine Kinase (Btk)ELISA Kit	96 Test	38220090	24,500.00
CLS0051GP	Guinea pig Catalase (CAT)ELISA Kit	96 Test	38220090	24,500.00
CLS0052GP	Guinea pig CD4 ELISA Kit	96 Test	38220090	24,500.00
CLS0053GP	Guinea pig Cluster Of Differentiation 83 (CD83)ELISA Kit	96 Test	38220090	24,500.00
CLS0054GP	Guinea pig Creatine Kinase, Mitochondrial 1A (CKMT1A)ELISA Kit	96 Test	38220090	24,500.00
CLS0055GP	Guinea pig Creatine Kinase, Mitochondrial 1B (CKMT1B)ELISA Kit	96 Test	38220090	24,500.00
CLS0056GP	Guinea Pig Endothelial nitric oxide synthase,eNOS ELISA Kit	96 Test	38220090	24,500.00
CLS0057GP	Guinea pig Epidermal growth factor,EGF ELISA Kit	96 Test	38220090	24,500.00
CLS0058GP	Guinea pig follicle-stimulating hormone,FSH ELISA Kit	96 Test	38220090	24,500.00
CLS0059GP	Guinea pig Growth hormone,GH ELISA Kit	96 Test	38220090	24,500.00
CLS0060GP	Guinea pig Hemoglobin Beta (HBb)ELISA Kit	96 Test	38220090	24,500.00
CLS0061GP	Guinea pig Heparin Binding Epidermal Growth Factor Like Growth Factor (HBEGF)ELISA Kit	96 Test	38220090	24,500.00
CLS0062GP	Guinea pig hepatocyte growth factor,HGF ELISA Kit	96 Test	38220090	24,500.00
CLS0063GP	Guinea pig Immunoglobulin A,IgA ELISA Kit	96 Test	38220090	24,500.00
CLS0064GP	Guinea pig Immunoglobulin G,IgG ELISA Kit	96 Test	38220090	24,500.00
CLS0065GP	Guinea pig Immunoglobulin G2,IgG2 ELISA kit	96 Test	38220090	24,500.00
CLS0066GP	Guinea Pig Interleukin 1 receptor antagonist, IL-1ra ELISA kit	96 Test	38220090	24,500.00

Cat.No.	Product Description	Pack Size	HSN	Unit Price
CLS0067GP	Guinea pig Interleukin-12,IL-12/P70 ELISA KIT	96 Test	38220090	24,500.00
CLS0068GP	Guinea pig interleukin5(IL-5) ELISA Kit	96 Test	38220090	24,500.00
CLS0069GP	Guinea pig intestinal fatty acid binding protein,iFABP ELISA Kit	96 Test	38220090	24,500.00
CLS0070GP	Guinea pig Leptospira IgG ELISA Kit	96 Test	38220090	24,500.00
CLS0071GP	Guinea pig leukotriene (LT) ELISA Kit	96 Test	38220090	24,500.00
CLS0072GP	Guinea pig leukotriene D4,LT-D4 ELISA Kit	96 Test	38220090	24,500.00
CLS0073GP	Guinea pig lysozyme (LYS) ELISA Kit	96 Test	38220090	24,500.00
CLS0074GP	Guinea pig major histocompatibility complex,MHC/GPLA ELISA Kit	96 Test	38220090	24,500.00
CLS0075GP	Guinea pig Mannose Associated Serine Protease 1 (MASP1)ELISA Kit	96 Test	38220090	24,500.00
CLS0076GP	Guinea pig matrix metalloproteinase 13 (MMP-13) ELISA Kit	96 Test	38220090	24,500.00
CLS0077GP	Guinea pig matrix metalloproteinase 9,MMP-9 ELISA Kit	96 Test	38220090	24,500.00
CLS0078GP	Guinea Pig monocyte chemotactic protein 4,MCP-4 ELISA kit	96 Test	38220090	24,500.00
CLS0079GP	Guinea pig Neurokinins A,NKA ELISA Kit	96 Test	38220090	24,500.00
CLS0080GP	Guinea pig Neurokinins B,NKB ELISA Kit	96 Test	38220090	24,500.00
CLS0081GP	Guinea pig Neutrophil peptide(NP) ELISA Kit	96 Test	38220090	24,500.00
CLS0082GP	Guinea pig Nibrin (NBN)ELISA Kit	96 Test	38220090	24,500.00
CLS0083GP	Guinea pig Nitric Oxide Synthase 3, Endothelial (NOS3)ELISA Kit	96 Test	38220090	24,500.00
CLS0084GP	Guinea pig nitric oxide,NO ELISA Kit	96 Test	38220090	24,500.00
CLS0085GP	Guinea Pig plasmin-antiplasmin complex,PAP ELISA Kit	96 Test	38220090	24,500.00
CLS0086GP	Guinea pig Protein Disulfide Isomerase (PDI)ELISA Kit	96 Test	38220090	24,500.00
CLS0087GP	Guinea pig P-Selectin (PS) ELISA Kit	96 Test	38220090	24,500.00
CLS0088GP	Guinea pig Specific Immunoglobulin E,SIgE ELISA KIT	96 Test	38220090	24,500.00
CLS0089GP	Guinea Pig Super Oxidase Dimutase,SOD ELISA Kit	96 Test	38220090	24,500.00
CLS0090GP	Guinea pig Superoxide Dismutase 2, Mitochondrial (SOD2)ELISA Kit	96 Test	38220090	24,500.00
CLS0091GP	Guinea pig Superoxide Dismutase, Copper Chaperone (SOD4)ELISA Kit	96 Test	38220090	24,500.00
CLS0092GP	Guinea pig telomerase,TE ELISA Kit	96 Test	38220090	24,500.00
CLS0093GP	Guinea pig tissue inhibitors of metalloproteinase 1,TIMP-1 ELISA Kit	96 Test	38220090	24,500.00
CLS0094GP	Guinea pig systemic lupus erythematosus,SLE ELISA Kit	96 Test	38220090	24,500.00
CLS0095GP	Guinea pig Islet amyloid polypeptide,IAPP ELISA Kit	96 Test	38220090	24,500.00
CLS0096GP	Guinea pig Prostaglandin reductase 1,PTGR1 ELISA Kit	96 Test	38220090	24,500.00
CLS0097GP	Guinea pig Cortisol(COR) ELISA Kit	96 Test	38220090	24,500.00
CLS0098GP	Guinea pig Neuromedin U (NMU)ELISA kit	96 Test	38220090	24,500.00
CLS0099GP	Guinea pig Interleukin 17(IL-17)ELISA Kit	96 Test	38220090	24,500.00
CLS0100GP	Guinea Pig Poliomyelitis Virus IgG(PV-IgG)ELISA Kit	96 Test	38220090	24,500.00
CLS0101GP	Guinea Pig Anti-Poliomyelitis Virus(PV-Ab)ELISA Kit	96 Test	38220090	24,500.00
CLS0001HA	Hamster Melatonin(MT)ELISA Kit	96 Test	38220090	24,500.00
CLS0002HA	Hamster Estradiol(E2)ELISA Kit	96 Test	38220090	24,500.00
CLS0003HA	Hamster Intercellular Adhesion Molecule 1 (ICAM1)ELISA Kit	96 Test	38220090	24,500.00
CLS0004HA	Hamster Bone Alkaline Phosphatase,BALP ELISA KIT	96 Test	38220090	24,500.00
CLS0005HA	Hamster Insulin(INS)ELISA Kit	96 Test	38220090	24,500.00
CLS0006HA	Hamster Interleukin 17(IL-17)ELISA Kit	96 Test	38220090	24,500.00
CLS0007HA	Hamster Immunoglobulin E(IgE)ELISA Kit	96 Test	38220090	24,500.00
CLS0008HA	Hamster apoprotein,apo-A1 ELISA Kit	96 Test	38220090	24,500.00
CLS0009HA	Hamster Interleukin 6,IL-6 ELISA KIT	96 Test	38220090	24,500.00
CLS0010HA	Hamster Cytochrome P450 7A1,CYP7A1 ELISA Kit	96 Test	38220090	24,500.00
CLS0011HA	Hamster Interferon α ,IFN- α ELISA Kit	96 Test	38220090	24,500.00
CLS0012HA	Hamster Interferon γ ,IFN- γ ELISA Kit	96 Test	38220090	24,500.00
CLS0013HA	Hamster peroxisome proliferators activator receptors alpha,PPAR- α ELISA Kit	96 Test	38220090	24,500.00
CLS0014HA	Hamster lipoprotein lipase,LPL ELISA Kit	96 Test	38220090	24,500.00

Cat.No.	Product Description	Pack Size	HSN	Unit Price
CLS0015HA	Hamster Immunoglobulin G1,IgG1 ELISA Kit	96 Test	38220090	24,500.00
CLS0016HA	Hamster 5-Hydroxytryptamine,5HT ELISA Kit	96 Test	38220090	24,500.00
CLS0017HA	Hamster Cortisol(COR) ELISA Kit	96 Test	38220090	24,500.00
CLS0018HA	Hamster inducible nitric oxide synthase,iNOS ELISA KIT	96 Test	38220090	24,500.00
CLS0019HA	Hamster 3-Nitrotyrosine,3-NT ELISA kit	96 Test	38220090	24,500.00
CLS0020HA	Hamster High mobility group protein B1,HMGB-1 ELISA Kit	96 Test	38220090	24,500.00
CLS0021HA	Hamster adiponectin,ADP ELISA Kit	96 Test	38220090	24,500.00
CLS0001NM	Nude mice Myeloid differentiation factor88 (MYD88) ELISA Kit	96 Test	38220090	24,500.00
CLS0002NM	Nude mice Toll Like Receptor 4 (TLR4) ELISA Kit	96 Test	38220090	24,500.00
CLS0001GO	Goat Super Oxidase Dimutase(SOD)ELISA Kit	96 Test	38220090	24,500.00
CLS0002GO	Goat Heat Shock Protein 27(HSP-27)ELISA Kit	96 Test	38220090	24,500.00
CLS0003GO	Goat Heat Shock Protein 72(HSP-72)ELISA Kit	96 Test	38220090	24,500.00
CLS0004GO	GOAT adrenocorticotrophic hormone(ACTH)ELISA Kit	96 Test	38220090	24,500.00
CLS0005GO	GOAT Thyroid Stimulating Hormone(TSH)ELISA Kit	96 Test	38220090	24,500.00
CLS0006GO	GOAT Estrogen(E)ELISA Kit	96 Test	38220090	24,500.00
CLS0007GO	GOAT Testosterone,T ELISA Kit	96 Test	38220090	24,500.00
CLS0008GO	GOAT gonadotropin-releasing hormone(GnRH)ELISA Kit	96 Test	38220090	24,500.00
CLS0009GO	GOAT protein tyrosine phosphatase(pty/ptpase)ELISA Kit	96 Test	38220090	24,500.00
CLS0010GO	GOAT Immunoglobulin A(IGA)ELISA Kit	96 Test	38220090	24,500.00
CLS0011GO	Goat Thyroxine,T4 ELISA KIT	96 Test	38220090	24,500.00
CLS0012GO	Goat Insulin Like Growth Factor Binding Protein 5,IGFBP5 ELISA KIT	96 Test	38220090	24,500.00
CLS0013GO	Goat Insulin Like Growth Factor Binding Protein 3,IGFBP3 ELISA KIT	96 Test	38220090	24,500.00
CLS0014GO	GOAT Melatonin(MT) ELISA Kit	96 Test	38220090	24,500.00
CLS0015GO	GOAT Heat Shock Protein 90(HSP90)ELISA Kit	96 Test	38220090	24,500.00
CLS0016GO	GOAT Interleukin 1,IL-1 ELISA Kit	96 Test	38220090	24,500.00
CLS0017GO	GOAT Immunoglobulin G(IGG) ELISA Kit	96 Test	38220090	24,500.00
CLS0018GO	GOAT Total Immunoglobulin G(Total IgG)ELISA Kit	96 Test	38220090	24,500.00
CLS0019GO	GOAT Serum amyloid A(SAA)ELISA Kit	96 Test	38220090	24,500.00
CLS0020GO	GOAT Immunoglobulin M(IgM) ELISA Kit	96 Test	38220090	24,500.00
CLS0021GO	GOAT Japanese Encephalitis IgG(JE IgG) ELISA Kit	96 Test	38220090	24,500.00
CLS0022GO	Goat Heat Shock Protein 90kDa Alpha A1(HSP90aA1)ELISA Kit	96 Test	38220090	24,500.00
CLS0023GO	Goat Heat shock protein 70(HSP70)ELISA Kit	96 Test	38220090	24,500.00
CLS0024GO	GOAT Progesterone,P ELISA Kit	96 Test	38220090	24,500.00
CLS0025GO	GOAT Resistin(Retn) ELISA Kit	96 Test	38220090	24,500.00
CLS0026GO	GOAT Transforming Growth factor β 1,TGF- β 1 ELISA kit	96 Test	38220090	24,500.00
CLS0027GO	GOAT Vascular Endothelial cell Growth Factor(VEGF) ELISA Kit	96 Test	38220090	24,500.00
CLS0028GO	GOAT Myostatin(MSTN) ELISA Kit	96 Test	38220090	24,500.00
CLS0029GO	GOAT non-ester fatty acid(NEFA)ELISA Kit	96 Test	38220090	24,500.00
CLS0030GO	GOAT prolactin,PRL ELISA Kit	96 Test	38220090	24,500.00
CLS0031GO	GOAT Growth hormone(GH) ELISA Kit	96 Test	38220090	24,500.00
CLS0032GO	GOAT Insulin-like growth factors 1,IGF-1 ELISA Kit	96 Test	38220090	24,500.00
CLS0033GO	GOAT Leptin(LEP) ELISA Kit	96 Test	38220090	24,500.00
CLS0034GO	GOAT Cortisol(COR) ELISA Kit	96 Test	38220090	24,500.00
CLS0035GO	Goat C-Reactive Protein(CRP) ELISA Kit	96 Test	38220090	24,500.00
CLS0036GO	GOAT Growth Hormone Releasing Peptide,GHRP ELISA Kit	96 Test	38220090	24,500.00
CLS0037GO	GOAT Insulin,INS ELISA Kit	96 Test	38220090	24,500.00
CLS0038GO	GOAT adiponectin,ADP ELISA Kit	96 Test	38220090	24,500.00
CLS0039GO	GOAT Amylin(Amy) ELISA Kit	96 Test	38220090	24,500.00
CLS0040GO	GOAT β -hydroxybutyric acid(BHBA)ELISA Kit	96 Test	38220090	24,500.00
CLS0041GO	GOAT Interferon γ ,IFN- γ ELISA Kit	96 Test	38220090	24,500.00
CLS0042GO	GOAT Tumor necrosis factor α ,TNF- α ELISA KIT	96 Test	38220090	24,500.00

Cat.No.	Product Description	Pack Size	HSN	Unit Price
CLS0043GO	GOAT α 1-Acid glycoprotein(α 1-AGP)ELISA Kit	96 Test	38220090	24,500.00
CLS0044GO	GOAT ferritin(Fe)ELISA Kit	96 Test	38220090	24,500.00
CLS0045GO	GOAT anti-diuretic hormone/vasopressin/arginine vasopressin,ADH/VP/AVP ELISA Kit	96 Test	38220090	24,500.00
CLS0046GO	GOAT Urotensin II(UII) ELISA Kit	96 Test	38220090	24,500.00
CLS0047GO	GOAT Vasoactive Intestinal Peptide,VIP ELISA Kit	96 Test	38220090	24,500.00
CLS0048GO	GOAT C-type natriuretic peptide,CNP ELISA Kit	96 Test	38220090	24,500.00
CLS0049GO	GOAT oxytocin,OT ELISA Kit	96 Test	38220090	24,500.00
CLS0050GO	GOAT aldosterone,ALD ELISA Kit	96 Test	38220090	24,500.00
CLS0051GO	GOAT Renin(Renin)ELISA Kit	96 Test	38220090	24,500.00
CLS0052GO	GOAT Beta-Hydroxybutyric Acid(β -OHB)ELISA Kit	96 Test	38220090	24,500.00
CLS0053GO	GOAT Folic Acid(FA)ELISA Kit	96 Test	38220090	24,500.00
CLS0054GO	GOAT Vitamin B12(VB12)ELISA Kit	96 Test	38220090	24,500.00
CLS0055GO	GOAT Arginase-1(ARG1)ELISA Kit	96 Test	38220090	24,500.00
CLS0056GO	GOAT Interleukin 13(IL-13)ELISA Kit	96 Test	38220090	24,500.00
CLS0057GO	GOAT Interleukin 4(IL-4)ELISA Kit	96 Test	38220090	24,500.00
CLS0058GO	GOAT Immunoglobulin E(IGE)ELISA Kit	96 Test	38220090	24,500.00
CLS0059GO	GOAT Three original acid iodine thyroid(T3) ELISA Kit	96 Test	38220090	24,500.00
CLS0060GO	GOAT Luteinizing Hormone(LH) ELISA Kit	96 Test	38220090	24,500.00
CLS0061GO	GOAT Follicle-Stimulating Hormone(FSH) ELISA Kit	96 Test	38220090	24,500.00
CLS0062GO	GOAT Immunoglobulin G1,IgG1 ELISA Kit	96 Test	38220090	24,500.00
CLS0063GO	GOAT Estradiol(E2) ELISA Kit	96 Test	38220090	24,500.00
CLS0064GO	GOAT Galanin,GAL ELISA Kit	96 Test	38220090	24,500.00
CLS0065GO	GOAT growth hormone releasing hormone(GHRH) ELISA Kit	96 Test	38220090	24,500.00
CLS0066GO	GOAT beta defensin 2,HBD2 ELISA kit	96 Test	38220090	24,500.00
CLS0067GO	GOAT Interleukin 1 α ,IL-1 α ELISA Kit	96 Test	38220090	24,500.00
CLS0068GO	GOAT Interleukin 1 β ,IL-1 β ELISA Kit	96 Test	38220090	24,500.00
CLS0069GO	GOAT Interleukin 2,IL-2 ELISA Kit	96 Test	38220090	24,500.00
CLS0070GO	GOAT Interleukin 6,IL-6 ELISA Kit	96 Test	38220090	24,500.00
CLS0071GO	GOAT Interleukin 18,IL-18 ELISA KIT	96 Test	38220090	24,500.00
CLS0072GO	GOAT Vitamin B,VB EELISA Kit	96 Test	38220090	24,500.00
CLS0073GO	GOAT Vitamin E,VE EELISA Kit	96 Test	38220090	24,500.00
CLS0074GO	GOAT platelet-derived growth factor-BB,PDGF-BB ELISA Kit	96 Test	38220090	24,500.00
CLS0075GO	GOAT Interleukin 1 α ,IL-1 α ELISA Kit	96 Test	38220090	24,500.00
CLS0076GO	GOAT Chitinase-3-like Protein 1(YKL-40/CHI3L1)ELISA Kit	96 Test	38220090	24,500.00
CLS0077GO	GOAT Angiotensin converting enzyme,ACE ELISA Kit	96 Test	38220090	24,500.00
CLS0078GO	GOAT Ischemia Modified Albumin,IMA ELISA Kit	96 Test	38220090	24,500.00
CLS0079GO	GOAT Glutathione reductase(GR)ELISA kit	96 Test	38220090	24,500.00
CLS0080GO	Goat Glutathione peroxidase(GSH-Px)ELISA Kit	96 Test	38220090	24,500.00
CLS0001CH	Chicken basic fibroblast growth factor(bFGF)ELISA Kit	96 Test	38220090	24,500.00
CLS0002CH	Chicken amilase(amilase)ELISA Kit	96 Test	38220090	24,500.00
CLS0003CH	Chicken Neuronal Nitric Oxide Synthase(nNOS/NOS1)ELISA Kit	96 Test	38220090	24,500.00
CLS0004CH	Chicken lactate dehydrogenase(LDH)ELISA Kit	96 Test	38220090	24,500.00
CLS0005CH	Chicken Lactase(Lactase)ELISA Kit	96 Test	38220090	24,500.00
CLS0006CH	Chicken D-lactic acid(D-LA)ELISA Kit	96 Test	38220090	24,500.00
CLS0007CH	Chicken secretory immunoglobulin A,SIgA ELISA Kit	96 Test	38220090	24,500.00
CLS0008CH	Chicken Lipopolysaccharides(LPS)ELISA Kit	96 Test	38220090	24,500.00
CLS0009CH	Chicken 25-Dihydroxy vitamin D3,HVD3 ELISA Kit	96 Test	38220090	24,500.00
CLS0010CH	Chicken Cholesterol(CH)ELISA Kit	96 Test	38220090	24,500.00
CLS0011CH	Chicken three glycerine(3-glycerine)ELISA Kit	96 Test	38220090	24,500.00
CLS0012CH	Chicken High density lipoprotein(HDL)ELISA Kit	96 Test	38220090	24,500.00
CLS0013CH	Chicken Low density lipoprotein(LDL)ELISA Kit	96 Test	38220090	24,500.00
CLS0014CH	Chicken Interleukin 11(IL-11)ELISA Kit	96 Test	38220090	24,500.00
CLS0015CH	Chicken Glutathione peroxidase,GSH-Px ELISA Kit	96 Test	38220090	24,500.00
CLS0016CH	Chicken Super Oxidase Dimutase,SOD ELISA Kit	96 Test	38220090	24,500.00
CLS0017CH	Chicken Tri-iodothyronine,T3 ELISA Kit	96 Test	38220090	24,500.00

Cat.No.	Product Description	Pack Size	HSN	Unit Price
CLS0018CH	Chicken prolactin(PRL)ELISA Kit	96 Test	38220090	24,500.00
CLS0019CH	Chicken Testosterone, T ELISA Kit	96 Test	38220090	24,500.00
CLS0020CH	Chicken Corticosterone, CORT ELISA Kit	96 Test	38220090	24,500.00
CLS0021CH	Chicken Tumor necrosis factor α , TNF- α ELISA Kit	96 Test	38220090	24,500.00
CLS0022CH	Chicken Interleukin 6, IL-6 ELISA Kit	96 Test	38220090	24,500.00
CLS0023CH	Chicken Interleukin 1 α , IL-1 α ELISA Kit	96 Test	38220090	24,500.00
CLS0024CH	Chicken Immunoglobulin G2, IgG2 ELISA KIT	96 Test	38220090	24,500.00
CLS0025CH	Chicken Immunoglobulin G1, IgG1 ELISA KIT	96 Test	38220090	24,500.00
CLS0026CH	Chicken Alanine Aminotransferase(ALT/GPT)ELISA Kit	96 Test	38220090	24,500.00
CLS0027CH	Chicken Aspartate Aminotransferase(AST)ELISA Kit	96 Test	38220090	24,500.00
CLS0028CH	Chicken Follicle-stimulating hormone, FSH ELISA Kit	96 Test	38220090	24,500.00
CLS0029CH	Chicken Luteinizing Hormone, LH ELISA Kit	96 Test	38220090	24,500.00
CLS0030CH	Chicken zonula occludens-1(ZO-1)ELISA Kit	96 Test	38220090	24,500.00
CLS0031CH	Chicken Troponin I(TN-I)ELISA Kit	96 Test	38220090	24,500.00
CLS0032CH	Chicken Troponin I, fast skeletal muscle(TNNI2) ELISA Kit	96 Test	38220090	24,500.00
CLS0033CH	Chicken Estradiol(E2)ELISA Kit	96 Test	38220090	24,500.00
CLS0034CH	Chicken Immunoglobulin of Yolk, IgY ELISA Kit	96 Test	38220090	24,500.00
CLS0035CH	Chicken Interleukin 1 β , IL-1 β ELISA Kit	96 Test	38220090	24,500.00
CLS0036CH	Chicken prolactin(PRL)ELISA Kit	96 Test	38220090	24,500.00
CLS0037CH	Chicken Interleukin 9(IL-9)ELISA Kit	96 Test	38220090	24,500.00
CLS0038CH	Chicken Tumor necrosis factor β (TNF- β)ELISA Kit	96 Test	38220090	24,500.00
CLS0039CH	Chicken toll-like receptor 4(TLR-4)ELISA Kit	96 Test	38220090	24,500.00
CLS0040CH	Chicken Heat Shock 70kDa Protein 5 (HSPA5)ELISA kit	96 Test	38220090	24,500.00
CLS0041CH	Chicken Interferon γ , IFN- γ ELISA Kit	96 Test	38220090	24,500.00
CLS0042CH	Chicken Nitric Oxide(NO)ELISA Kit	96 Test	38220090	24,500.00
CLS0043CH	Chicken Glutamate dehydrogenase(GDH/GLDH)ELISA Kit	96 Test	38220090	24,500.00
CLS0044CH	Chicken Alkaline phosphatase(ALP)ELISA Kit	96 Test	38220090	24,500.00
CLS0045CH	Chicken interleukin 8, IL-8 ELISA Kit	96 Test	38220090	24,500.00
CLS0046CH	Chicken Thyroxine, T4 ELISA Kit	96 Test	38220090	24,500.00
CLS0047CH	Chicken Interleukin 5(IL-5)ELISA Kit	96 Test	38220090	24,500.00
CLS0048CH	Chicken Interferon α (IFN- α)ELISA Kit	96 Test	38220090	24,500.00
CLS0049CH	Chicken C-Reactive Protein(CRP)ELISA Kit	96 Test	38220090	24,500.00
CLS0050CH	Chicken cluster Of differentiation, CD8 ELISA Kit	96 Test	38220090	24,500.00
CLS0051CH	Chicken cluster Of differentiation, CD4 ELISA Kit	96 Test	38220090	24,500.00
CLS0052CH	Chicken Serum total protein, TP ELISA Kit	96 Test	38220090	24,500.00
CLS0053CH	Chicken Serum albumin, HSA ELISA Kit	96 Test	38220090	24,500.00
CLS0054CH	Chicken Osteoprotegerin(OPG)ELISA Kit	96 Test	38220090	24,500.00
CLS0055CH	Chicken prolactin(PRL)ELISA Kit	96 Test	38220090	24,500.00
CLS0056CH	Chicken Prostaglandin E2, PG-E2 ELISA Kit	96 Test	38220090	24,500.00
CLS0057CH	Chicken Metallothionein, MT ELISA Kit	96 Test	38220090	24,500.00
CLS0058CH	Chicken Melatonin, MT ELISA Kit	96 Test	38220090	24,500.00
CLS0059CH	Chicken Leptin, LEP ELISA Kit	96 Test	38220090	24,500.00
CLS0060CH	Chicken Liver Type Fatty Acid Binding Protein(L-FABP)ELISA Kit	96 Test	38220090	24,500.00
CLS0061CH	Chicken Interleukin 2, IL-2 ELISA Kit	96 Test	38220090	24,500.00
CLS0062CH	Chicken Interleukin 12, IL-12 ELISA Kit	96 Test	38220090	24,500.00
CLS0063CH	Chicken Interleukin 17, IL-17 ELISA Kit	96 Test	38220090	24,500.00
CLS0064CH	Chicken Immunoglobulin M, IgM ELISA Kit	96 Test	38220090	24,500.00
CLS0065CH	Chicken Interleukin 1(IL-1)ELISA Kit	96 Test	38220090	24,500.00
CLS0066CH	Chicken Immunoglobulin A, IgA ELISA Kit	96 Test	38220090	24,500.00
CLS0067CH	Chicken Immunoglobulin G, IgG ELISA Kit	96 Test	38220090	24,500.00
CLS0068CH	Chicken Haptoglobin, Hpt/HP ELISA Kit	96 Test	38220090	24,500.00
CLS0069CH	Chicken Transforming Growth factor β 1, TGF- β 1 ELISA kit	96 Test	38220090	24,500.00
CLS0070CH	Chicken Phosphorylated adenosine monophosphate activated protein kinase, AMPK ELISA kit	96 Test	38220090	24,500.00
CLS0071CH	Chicken Progesterone, PROG ELISA Kit	96 Test	38220090	24,500.00
CLS0072CH	Chicken norepinephrine, NE ELISA Kit	96 Test	38220090	24,500.00
CLS0073CH	Chicken interleukin 4, IL-4 ELISA Kit	96 Test	38220090	24,500.00
CLS0074CH	Chicken Interleukin 10, IL-10 ELISA Kit	96 Test	38220090	24,500.00

Cat.No.	Product Description	Pack Size	HSN	Unit Price
CLS0075CH	Chicken Insulin,INS ELISA Kit	96 Test	38220090	24,500.00
CLS0076CH	Chicken Insulin-like growth factor 1(IGF-1)ELISA Kit	96 Test	38220090	24,500.00
CLS0077CH	Chicken Insulin-like growth factor binding protein 1(IGFBP-1)ELISA Kit	96 Test	38220090	24,500.00
CLS0078CH	Chicken Growth hormone,GH ELISA Kit	96 Test	38220090	24,500.00
CLS0079CH	Chicken Glutathione,GSH ELISA Kit	96 Test	38220090	24,500.00
CLS0080CH	Chicken Complement 3,C3 ELISA Kit	96 Test	38220090	24,500.00
CLS0081CH	Chicken Complement 4,C4 ELISA Kit	96 Test	38220090	24,500.00
CLS0082CH	Chicken Cortisol(COR) ELISA Kit	96 Test	38220090	24,500.00
CLS0083CH	Chicken Glucagon,GC ELISA Kit	96 Test	38220090	24,500.00
CLS0084CH	Chicken growth hormone secretagogue receptor 1 alpha(GHSR1a)ELISA Kit	96 Test	38220090	24,500.00
CLS0085CH	Chicken 8-Hydroxy-desoxyguanosine,8-OHdG ELISA Kit	96 Test	38220090	24,500.00
CLS0086CH	Chicken Acetyl Coenzyme A carboxylase alpha,ACACA ELISA Kit	96 Test	38220090	24,500.00
CLS0087CH	Chicken adiponectin,ADP ELISA Kit	96 Test	38220090	24,500.00
CLS0088CH	Chicken Catalase (CAT)ELISA Kit	96 Test	38220090	24,500.00
CLS0089CH	Chicken Epinephrine/Adrenaline,EPI ELISA Kit	96 Test	38220090	24,500.00
CLS0090CH	Chicken Estrogen,E ELISA Kit	96 Test	38220090	24,500.00
CLS0091CH	Chicken Gelsolin,GS ELISA Kit	96 Test	38220090	24,500.00
CLS0092CH	Chicken Glucocorticoid receptor,GR ELISA Kit	96 Test	38220090	24,500.00
CLS0093CH	Chicken glutathione S-transferases,GSTs ELISA Kit	96 Test	38220090	24,500.00
CLS0094CH	Chicken Heat Shock Protein 70,HSP-70 ELISA Kit	96 Test	38220090	24,500.00
CLS0095CH	Chicken Protein lin-28 homolog B(LIN28B) ELISA Kit	96 Test	38220090	24,500.00
CLS0096CH	Chicken Cathepsin B,cath-B ELISA Kit	96 Test	38220090	24,500.00
CLS0097CH	Chicken Growth Differentiation Factor 8 (GDF8)ELISA kit	96 Test	38220090	24,500.00
CLS0098CH	Chicken Heat Shock Protein 90kDa Alpha A1 (HSP90aA1)ELISA kit	96 Test	38220090	24,500.00
CLS0099CH	Chicken Heat Shock Protein 90kDa Beta 1 (HSP90b1)ELISA kit	96 Test	38220090	24,500.00
CLS0100CH	Chicken Myostatin,MSTN ELISA Kit	96 Test	38220090	24,500.00
CLS0101CH	Chicken Heparanase,HPA ELISA kit	96 Test	38220090	24,500.00
CLS0102CH	Chicken Caldesmon,CALD1 ELISA Kit	96 Test	38220090	24,500.00
CLS0103CH	Chicken Histone deacetylase 1,HDAC1 ELISA KIT	96 Test	38220090	24,500.00
CLS0104CH	Chicken Follistatin,FS ELISA Kit	96 Test	38220090	24,500.00
CLS0105CH	Chicken Hemoglobin subunit alpha-A(HBAA)ELISA Kit	96 Test	38220090	24,500.00
CLS0106CH	Chicken Hemoglobin subunit beta(HBB) ELISA Kit	96 Test	38220090	24,500.00
CLS0107CH	Chicken Sclerostin domain-containing protein 1(SOSTDC1)ELISA Kit	96 Test	38220090	24,500.00
CLS0108CH	Chicken Transthyretin,TTR ELISA Kit	96 Test	38220090	24,500.00
CLS0109CH	Chicken Alpha-type platelet-derived growth factor receptor,PDGFRA ELISA kit	96 Test	38220090	24,500.00
CLS0110CH	Chicken Platelet-derived growth factor C,PDGF-C ELISA kit	96 Test	38220090	24,500.00
CLS0111CH	Chicken Beclin1,BECN1 ELISA kit	96 Test	38220090	24,500.00
CLS0112CH	Chicken Secretin(SCT) ELISA Kit	96 Test	38220090	24,500.00
CLS0113CH	Chicken Zinc finger E-box-binding homeobox 1 ,ZEB1 ELISA Kit	96 Test	38220090	24,500.00
CLS0114CH	Chicken ELL-associated factor 2(EAF2) ELISA Kit	96 Test	38220090	24,500.00
CLS0115CH	Chicken progesterone receptor,PGR ELISA Kit	96 Test	38220090	24,500.00
CLS0116CH	Chicken Angiotensin converting enzyme,ACE ELISA Kit	96 Test	38220090	24,500.00
CLS0117CH	Chicken Cytochrome P450 19A1,CYP19A1 ELISA Kit	96 Test	38220090	24,500.00
CLS0118CH	Chicken Steroid 17-alpha-hydroxylase/17,20 lyase;Cytochrome P450 17A1,CYP17A1 ELISA Kit	96 Test	38220090	24,500.00
CLS0119CH	Chicken DNA repair protein RAD51 homolog 1(RAD51) ELISA Kit	96 Test	38220090	24,500.00
CLS0120CH	Chicken Troponin T, slow skeletal muscle(TNNT3) ELISA Kit	96 Test	38220090	24,500.00
CLS0121CH	Chicken cardiac troponin I ,cTn- I ELISA Kit	96 Test	38220090	24,500.00
CLS0122CH	Chicken Pancreatic Polypeptide,PP ELISA Kit	96 Test	38220090	24,500.00

Cat.No.	Product Description	Pack Size	HSN	Unit Price
CLS0123CH	Chicken proteolipid protein,PLP ELISA Kit	96 Test	38220090	24,500.00
CLS0124CH	Chicken High mobility group protein B1,HMGB-1 ELISA Kit	96 Test	38220090	24,500.00
CLS0125CH	Chicken high mobility group protein 17,HMG-17 ELISA Kit	96 Test	38220090	24,500.00
CLS0126CH	Chicken Vascular Endothelial cell Growth Factor A,VEGF-A ELISA KIT	96 Test	38220090	24,500.00
CLS0127CH	Chicken secreted protein acidic and rich in cysteine,SPARC ELISA Kit	96 Test	38220090	24,500.00
CLS0128CH	Chicken Galanin,GAL ELISA Kit	96 Test	38220090	24,500.00
CLS0129CH	Chicken Ornithine decarboxylase,ODC1 ELISA Kit	96 Test	38220090	24,500.00
CLS0130CH	Chicken Neopterin(NEOP) ELISA Kit	96 Test	38220090	24,500.00
CLS0131CH	Chicken Dickkopf-3,DKK3 ELISA Kit	96 Test	38220090	24,500.00
CLS0132CH	Chicken Hyaluronan synthase 2,HAS2 ELISA Kit	96 Test	38220090	24,500.00
CLS0133CH	Chicken Hyaluronan synthase 3,HAS3 ELISA Kit	96 Test	38220090	24,500.00
CLS0134CH	Chicken Hormone sensitive lipase,HSL ELISA Kit	96 Test	38220090	24,500.00
CLS0135CH	Chicken Thymidine kinase, cytosolic(TK1) ELISA Kit	96 Test	38220090	24,500.00
CLS0136CH	Chicken Acetyl-Coa Carboxylase(ACC) ELISA Kit	96 Test	38220090	24,500.00
CLS0137CH	Chicken transferrin receptor,TFR ELISA Kit	96 Test	38220090	24,500.00
CLS0138CH	Chicken G1/S-specific Cyclin-D1,Cyclin-D1 ELISA Kit	96 Test	38220090	24,500.00
CLS0139CH	Chicken Collagen type I alpha 2,COL1A2/Collagen I ELISA Kit	96 Test	38220090	24,500.00
CLS0140CH	Chicken Zinc finger CCCH domain-containing protein 15,ZC3H15 ELISA Kit	96 Test	38220090	24,500.00
CLS0141CH	Chicken Inward rectifier potassium channel 2,KCNJ2 ELISA Kit	96 Test	38220090	24,500.00
CLS0142CH	Chicken G protein-activated inward rectifier potassium channel 1,KCNJ3/GIRK1 ELISA Kit	96 Test	38220090	24,500.00
CLS0143CH	Chicken Deoxyribonuclease 1,DNase-1 ELISA Kit	96 Test	38220090	24,500.00
CLS0144CH	Chicken phosphoenolpyruvate carboxykinase,PCK ELISA Kit	96 Test	38220090	24,500.00
CLS0145CH	Chicken Neuropilin-1(NRP1)ELISA kit	96 Test	38220090	24,500.00
CLS0146CH	Chicken Acetylcholinesterase,AChE ELISA Kit	96 Test	38220090	24,500.00
CLS0147CH	Chicken Noggin,NOG ELISA Kit	96 Test	38220090	24,500.00
CLS0148CH	Chicken Pyruvate kinase isozymes M1/M2,M2-PK ELISA Kit	96 Test	38220090	24,500.00
CLS0149CH	Chicken Rho Guanine Nucleotide Exchange Factor 3(ARHGEF3)ELISA Kit	96 Test	38220090	24,500.00
CLS0150CH	Chicken Rho Guanine Nucleotide Exchange Factor 6(ARHGEF6)ELISA Kit	96 Test	38220090	24,500.00
CLS0151CH	Chicken Cyclic AMP-dependent transcription factor ATF-2,ATF2 ELISA kit	96 Test	38220090	24,500.00
CLS0152CH	Chicken Hemopexin,HPX ELISA kit	96 Test	38220090	24,500.00
CLS0153CH	Chicken Glucose transporter 1,GLUT1/SLC2A1 ELISA Kit	96 Test	38220090	24,500.00
CLS0154CH	Chicken DNA-dependent protein kinase catalytic subunit,PRKDC ELISA Kit	96 Test	38220090	24,500.00
CLS0155CH	Chicken Retinal dehydrogenase 1,ALDH1A1 ELISA Kit	96 Test	38220090	24,500.00
CLS0156CH	Chicken Cadherin 11 (CDH11/CAD11)ELISA Kit	96 Test	38220090	24,500.00
CLS0157CH	Chicken Fibronectin,FN ELISA Kit	96 Test	38220090	24,500.00
CLS0158CH	Chicken Estrogen Receptor beta,ER-beta ELISA Kit	96 Test	38220090	24,500.00
CLS0159CH	Chicken Annexin A1 (ANXA1)ELISA Kit	96 Test	38220090	24,500.00
CLS0160CH	Chicken Annexin A6 (ANXA6)ELISA Kit	96 Test	38220090	24,500.00
CLS0161CH	Chicken Glutamate oxaloacetate transaminase 1,GOT1 ELISA Kit	96 Test	38220090	24,500.00
CLS0162CH	Chicken Transcription factor GATA-5,GATA5 ELISA Kit	96 Test	38220090	24,500.00
CLS0163CH	Chicken Neuromedin U (NMU)ELISA kit	96 Test	38220090	24,500.00
CLS0164CH	Chicken Ferritin(Fe)ELISA Kit	96 Test	38220090	24,500.00
CLS0001SH	Sheep Follicle-stimulating hormone(FSH)ELISA Kit	96 Test	38220090	24,500.00
CLS0002SH	Sheep Alpha-1-macroglobulin,Alpha-1-M ELISA Kit	96 Test	38220090	24,500.00
CLS0003SH	Sheep Immunoglobulin G,IgG ELISA Kit	96 Test	38220090	24,500.00

Cat.No.	Product Description	Pack Size	HSN	Unit Price
CLS0004SH	Sheep Haptoglobin,Hpt/HP ELISA Kit	96 Test	38220090	24,500.00
CLS0005SH	Sheep Lactate Dehydrogenase,LDH ELISA Kit	96 Test	38220090	24,500.00
CLS0006SH	Sheep Immunoglobulin M,IgM ELISA Kit	96 Test	38220090	24,500.00
CLS0007SH	Sheep Prolactin,PRL ELISA Kit	96 Test	38220090	24,500.00
CLS0008SH	Sheep Luteinizing Hormone(LH)ELISA Kit	96 Test	38220090	24,500.00
CLS0009SH	Sheep Serum amyloid A,SAA ELISA Kit	96 Test	38220090	24,500.00
CLS0010SH	Sheep Interleukin 1 α ,IL-1 α ELISA Kit	96 Test	38220090	24,500.00
CLS0011SH	Sheep Matrix metalloproteinase 1,MMP-1 ELISA kit	96 Test	38220090	24,500.00
CLS0012SH	Sheep Biglycan (BGN)ELISA Kit	96 Test	38220090	24,500.00
CLS0013SH	Sheep Transforming Growth factor β 1,TGF- β 1 ELISA kit	96 Test	38220090	24,500.00
CLS0014SH	Sheep Collagen Type II,Col II ELISA Kit	96 Test	38220090	24,500.00
CLS0015SH	Sheep Testosterone,T ELISA Kit	96 Test	38220090	24,500.00
CLS0016SH	Sheep Phosphoglucomutase 1 (PGM1)ELISA kit	96 Test	38220090	24,500.00
CLS0017SH	Sheep Obestatin(OB)ELISA Kit	96 Test	38220090	24,500.00
CLS0018SH	Sheep Ischemia Modified Albumin(IMA)ELISA Kit	96 Test	38220090	24,500.00
CLS0019SH	Sheep Interleukin 2,IL-2 ELISA Kit	96 Test	38220090	24,500.00
CLS0020SH	Sheep Glutathione peroxidase(GPX)ELISA Kit	96 Test	38220090	24,500.00
CLS0021SH	Sheep Cortisol(COR) ELISA Kit	96 Test	38220090	24,500.00
CLS0022SH	Sheep non-ester fatty acid(NEFA)ELISA Kit	96 Test	38220090	24,500.00
CLS0023SH	Sheep lipopolysaccharide binding protein(LBP)ELISA Kit	96 Test	38220090	24,500.00
CLS0024SH	Sheep Interferon γ (IFN- γ)ELISA Kit	96 Test	38220090	24,500.00
CLS0025SH	Sheep Glutathione peroxidase 1(GPX1)ELISA Kit	96 Test	38220090	24,500.00
CLS0026SH	Sheep Super Oxidase Dimutase(SOD)ELISA Kit	96 Test	38220090	24,500.00
CLS0027SH	Sheep Serotonin(ST)ELISA Kit	96 Test	38220090	24,500.00
CLS0028SH	Sheep Growth hormone(GH)ELISA Kit	96 Test	38220090	24,500.00
CLS0029SH	Sheep Interleukin 1 β (IL-1 β)ELISA Kit	96 Test	38220090	24,500.00
CLS0030SH	Sheep Malondialdehyde(MDA)ELISA KIT	96 Test	38220090	24,500.00
CLS0031SH	Sheep Tumor necrosis factor α (TNF- α)ELISA KIT	96 Test	38220090	24,500.00
CLS0032SH	Sheep Insulin(INS)ELISA Kit	96 Test	38220090	24,500.00
CLS0033SH	Sheep Nitric Oxide,NO Elisa	96 Test	38220090	24,500.00
CLS0034SH	Sheep luteotropic hormone(LH)ELISA Kit	96 Test	38220090	24,500.00
CLS0035SH	Sheep ferritin(FE)ELISA Kit	96 Test	38220090	24,500.00
CLS0036SH	Sheep Retinol binding protein(RBP)ELISA Kit	96 Test	38220090	24,500.00
CLS0037SH	Sheep Vitamin A(VA)ELISA Kit	96 Test	38220090	24,500.00
CLS0038SH	Sheep Beta-carotene oxygenase 2(BCO2)ELISA Kit	96 Test	38220090	24,500.00
CLS0039SH	sheep Ghrelin/obestatin prepropeptide(GHRL)ELISA Kit	96 Test	38220090	24,500.00
CLS0040SH	Sheep Kisspeptin 1(KISS-1) ELISA Kit	96 Test	38220090	24,500.00
CLS0041SH	Sheep Interleukin 5(IL-5)ELISA Kit	96 Test	38220090	24,500.00
CLS0042SH	Sheep Interleukin 10(IL-10)ELISA Kit	96 Test	38220090	24,500.00
CLS0043SH	Sheep Interleukin 12(IL-12)ELISA Kit	96 Test	38220090	24,500.00
CLS0044SH	Sheep Cystatin C(Cys-C)ELISA Kit	96 Test	38220090	24,500.00
CLS0045SH	Sheep Progesterone,PROG ELISA Kit	96 Test	38220090	24,500.00
CLS0046SH	Sheep Trypanothione reductase(TPR)ELISA Kit	96 Test	38220090	24,500.00
CLS0047SH	Sheep Estradiol(E2)ELISA Kit	96 Test	38220090	24,500.00
CLS0048SH	Sheep cluster of differentiation 8(CD8)ELISA Kit	96 Test	38220090	24,500.00
CLS0049SH	Sheep cluster of differentiation 4(CD4)ELISA Kit	96 Test	38220090	24,500.00
CLS0050SH	Sheep neutrophil gelatinase-associated lipocalin(NGAL)ELISA Kit	96 Test	38220090	24,500.00
CLS0051SH	Sheep Tri-iodothyronine(T3)ELISA Kit	96 Test	38220090	24,500.00
CLS0052SH	Sheep Thyroxine,T4 ELISA Kit	96 Test	38220090	24,500.00
CLS0053SH	Sheep Interleukin 1(IL-1)ELISA Kit	96 Test	38220090	24,500.00
CLS0054SH	Sheep Beta-Hydroxybutyric Acid(β -OHB)ELISA Kit	96 Test	38220090	24,500.00
CLS0055SH	Sheep Triglyceride(TG)ELISA Kit	96 Test	38220090	24,500.00
CLS0056SH	Sheep Heparin-binding growth factor 1(HO-1)ELISA Kit	96 Test	38220090	24,500.00
CLS0057SH	Sheep Epidermal growth factor(EGF)ELISA Kit	96 Test	38220090	24,500.00
CLS0058SH	Sheep transforming growth factor β (TGF- β)ELISA Kit	96 Test	38220090	24,500.00
CLS0059SH	Sheep Vascular Endothelial cell growth factor(VEGF)ELISA Kit	96 Test	38220090	24,500.00
CLS0060SH	Sheep Interleukin 6(IL-6)ELISA Kit	96 Test	38220090	24,500.00

Cat.No.	Product Description	Pack Size	HSN	Unit Price
CLS0061SH	Sheep tissue inhibitors of metalloproteinase(TIMP-1)ELISA Kit	96 Test	38220090	24,500.00
CLS0062SH	Sheep Interleukin 8(IL-8)ELISA Kit	96 Test	38220090	24,500.00
CLS0063SH	Sheep Fibroblast Growth Factor 1(FGF1)ELISA Kit	96 Test	38220090	24,500.00
CLS0064SH	Sheep Tyrosine-protein kinase ABL(ABL)ELISA Kit	96 Test	38220090	24,500.00
CLS0065SH	Sheep total Tau proteins(t)ELISA Kit	96 Test	38220090	24,500.00
CLS0066SH	Sheep Albumin(Albumin)ELISA Kit	96 Test	38220090	24,500.00
CLS0067SH	Sheep 4-Hydroxynonenal,4HNE ELISA Kit	96 Test	38220090	24,500.00
CLS0068SH	Sheep Immunoglobulin E,IgE ELISA Kit	96 Test	38220090	24,500.00
CLS0069SH	Sheep lipid peroxide,LPO ELISA Kit	96 Test	38220090	24,500.00
CLS0070SH	Sheep myeloperoxidase,MPO ELISA Kit	96 Test	38220090	24,500.00
CLS0071SH	Sheep Japanese Encephalitis IgG(JEV IgG) ELISA Kit	96 Test	38220090	24,500.00
CLS0072SH	Sheep platelet-derived growth factor-BB,PDGF-BB ELISA Kit	96 Test	38220090	24,500.00
CLS0073SH	Sheep Hemoglobin subunit beta(HBB) ELISA Kit	96 Test	38220090	24,500.00
CLS0074SH	Sheep Islet amyloid polypeptide,IAPP ELISA Kit	96 Test	38220090	24,500.00
CLS0075SH	Sheep Chitinase-3-like Protein 1(YKL-40/CHI3L1)ELISA Kit	96 Test	38220090	24,500.00
CLS0076SH	Sheep Free Tri-iodothyronine Indes,Free-T3 ELISA Kit	96 Test	38220090	24,500.00
CLS0077SH	Sheep Free Thyroxine,FT4 ELISA Kit	96 Test	38220090	24,500.00
CLS0078SH	Sheep Dihydrotestosterone,DHT ELISA Kit	96 Test	38220090	24,500.00
CLS0079SH	Sheep 17-Hydroxyprogesterone,17-OHP ELISA Kit	96 Test	38220090	24,500.00
CLS0080SH	Sheep adiponectin,ADP ELISA Kit	96 Test	38220090	24,500.00
CLS0081SH	Sheep Fructose-1,6-bisphosphatase 1,FBP1 ELISA kit	96 Test	38220090	24,500.00
CLS0082SH	Sheep Retinal dehydrogenase 1,ALDH1A1 ELISA Kit	96 Test	38220090	24,500.00
CLS0083SH	Sheep Adrenocorticotrophic hormone,ACTH ELISA Kit	96 Test	38220090	24,500.00
CLS0084SH	Sheep Orexin A(Orexin A)ELISA Kit	96 Test	38220090	24,500.00
CLS0085SH	Sheep Estrogen (E) ELISA Kit	96 Test	38220090	24,500.00
CLS0086SH	Sheep Leptin(LEP)ELISA Kit	96 Test	38220090	24,500.00
CLS0087SH	Sheep 13,14-dihydro-15-keto-prostaglandin F2-alpha(PGFM)ELISA Kit	96 Test	38220090	24,500.00
CLS0001BO	Bovine Anti-Thrombin III,AT-III ELISA Kit	96 Test	38220090	24,500.00
CLS0002BO	Bovine Diacyl glycerol,DAG/DG ELISA kit	96 Test	38220090	24,500.00
CLS0003BO	Bovine Estradiol,E2 ELISA Kit	96 Test	38220090	24,500.00
CLS0004BO	Bovine glutathione,GSH ELISA Kit	96 Test	38220090	24,500.00
CLS0005BO	Bovine Hemoglobin subunit alpha(HBA)ELISA Kit	96 Test	38220090	24,500.00
CLS0006BO	Bovine malondialdehyde,MDA ELISA Kit	96 Test	38220090	24,500.00
CLS0007BO	Bovine Lactoferrin,LTF/LF ELISA kit	96 Test	38220090	24,500.00
CLS0008BO	Bovine Interleukin 1β,IL-1β ELISA Kit	96 Test	38220090	24,500.00
CLS0009BO	Bovine Interleukin 1α,IL-1α ELISA Kit	96 Test	38220090	24,500.00
CLS0010BO	Bovine Hemoglobin subunit beta(HBB) ELISA Kit	96 Test	38220090	24,500.00
CLS0011BO	Bovine Non-esterified fatty acid,NEFA ELISA Kit	96 Test	38220090	24,500.00
CLS0012BO	Bovine plasminogen activator inhibitor 1,PAI-1 ELISA Kit	96 Test	38220090	24,500.00
CLS0013BO	Bovine Progesterone,PROG ELISA Kit	96 Test	38220090	24,500.00
CLS0014BO	Bovine Prostaglandin E2,PG-E2 ELISA Kit	96 Test	38220090	24,500.00
CLS0015BO	Bovine Prostaglandin F2α,PGF2α ELISA Kit	96 Test	38220090	24,500.00
CLS0016BO	Bovine Thrombin-antithrombin complex,TAT ELISA Kit	96 Test	38220090	24,500.00
CLS0017BO	Bovine Procalcitonin,PCT ELISA Kit	96 Test	38220090	24,500.00
CLS0018BO	Bovine Haptoglobin,Hpt/HP ELISA Kit	96 Test	38220090	24,500.00
CLS0019BO	Bovine Epinephrine/Adrenaline,EPI ELISA Kit	96 Test	38220090	24,500.00
CLS0020BO	Bovine Tumor necrosis factor α,TNF-α ELISA Kit	96 Test	38220090	24,500.00
CLS0021BO	Bovine Serum amyloid A,SAA ELISA Kit	96 Test	38220090	24,500.00
CLS0022BO	Bovine basic fibroblast growth factor 4,bFGF-4 ELISA Kit	96 Test	38220090	24,500.00
CLS0023BO	Bovine Paraoxonase-1,PON1 ELISA Kit	96 Test	38220090	24,500.00
CLS0024BO	Bovine Soluble Cluster of differentiation 30 ligand,sCD30L ELISA Kit	96 Test	38220090	24,500.00
CLS0025BO	Bovine Receptor I for the Fc region of immunoglobulin A,FcαR I ELISA Kit	96 Test	38220090	24,500.00
CLS0026BO	Bovine Interleukin 4,IL-4 ELISA Kit	96 Test	38220090	24,500.00

Cat.No.	Product Description	Pack Size	HSN	Unit Price
CLS0027BO	Bovine Interleukin 12,IL-12 ELISA Kit	96 Test	38220090	24,500.00
CLS0028BO	Bovine Interleukin 17,IL-17 ELISA Kit	96 Test	38220090	24,500.00
CLS0029BO	Bovine Annexin A2,Anxa2 ELISA Kit	96 Test	38220090	24,500.00
CLS0030BO	Bovine Annexin A1 (ANXA1)ELISA Kit	96 Test	38220090	24,500.00
CLS0031BO	Bovine Interleukin 2,IL-2 ELISA kit	96 Test	38220090	24,500.00
CLS0032BO	Bovine Desmosine,DES ELISA Kit	96 Test	38220090	24,500.00
CLS0033BO	Bovine β -hydroxybutyric acid(BHBA)ELISA Kit	96 Test	38220090	24,500.00
CLS0034BO	Bovine Immunoglobulin M,IgM ELISA Kit	96 Test	38220090	24,500.00
CLS0035BO	Bovine Immunoglobulin E(IgE)ELISA Kit	96 Test	38220090	24,500.00
CLS0036BO	Bovine Immunoglobulin D(IgD)ELISA Kit	96 Test	38220090	24,500.00
CLS0037BO	Bovine High mobility group protein B1,HMGB-1 ELISA Kit	96 Test	38220090	24,500.00
CLS0038BO	Bovine heat shock protein 27,HSP-27 ELISA Kit	96 Test	38220090	24,500.00
CLS0039BO	Bovine F-box only protein 39(FBXO39)ELISA Kit	96 Test	38220090	24,500.00
CLS0040BO	Bovine Insulin Like Growth Factor Binding Protein 3 (IGFBP3) ELISA Kit	96 Test	38220090	24,500.00
CLS0041BO	Bovine Insulin,INS ELISA Kit	96 Test	38220090	24,500.00
CLS0042BO	Bovine Immunoglobulin A,IgA ELISA Kit	96 Test	38220090	24,500.00
CLS0043BO	Bovine Glutathione peroxidase,GSH-Px ELISA Kit	96 Test	38220090	24,500.00
CLS0044BO	Bovine Fibrinogen(Fbg)ELISA Kit	96 Test	38220090	24,500.00
CLS0045BO	Bovine Beta-Hydroxybutyric Acid, β -OHB ELISA Kit	96 Test	38220090	24,500.00
CLS0046BO	Bovine neutrophil gelatinase-associated lipocalin(NGAL)ELISA Kit	96 Test	38220090	24,500.00
CLS0047BO	Bovine N-acetyl- β -D-glucosaminidase,NAG ELISA Kit	96 Test	38220090	24,500.00
CLS0048BO	Bovine Tissue inhibitors of metalloproteinase 1,TIMP-1 ELISA Kit	96 Test	38220090	24,500.00
CLS0049BO	Bovine Super Oxidase Dimutase,SOD ELISA Kit	96 Test	38220090	24,500.00
CLS0050BO	Bovine Protein kinase C(PKC)ELISA Kit	96 Test	38220090	24,500.00
CLS0051BO	Bovine Interleukin 1,IL-1 ELISA Kit	96 Test	38220090	24,500.00
CLS0052BO	Bovine Insulin-like growth factors 1,IGF-1 ELISA Kit	96 Test	38220090	24,500.00
CLS0053BO	Bovine Angiopoietin-like protein 4,ANGPTL4 ELISA Kit	96 Test	38220090	24,500.00
CLS0054BO	Bovine Lysozyme(LZM)ELISA Kit	96 Test	38220090	24,500.00
CLS0055BO	Bovine Luteinizing Hormone,LH ELISA Kit	96 Test	38220090	24,500.00
CLS0056BO	Bovine Chitinase-3-like Protein 1(YKL-40/CHI3L1)ELISA Kit	96 Test	38220090	24,500.00
CLS0057BO	Bovine Prostaglandin FM(PGFM)ELISA Kit	96 Test	38220090	24,500.00
CLS0058BO	Bovine Prostaglandin EF(PGEF)ELISA Kit	96 Test	38220090	24,500.00
CLS0059BO	Bovine cyclooxygenase-2,COX-2 ELISA KIT	96 Test	38220090	24,500.00
CLS0060BO	Bovine Cortisol(COR) ELISA Kit	96 Test	38220090	24,500.00
CLS0061BO	Bovine Testosterone,T ELISA Kit	96 Test	38220090	24,500.00
CLS0062BO	Bovine C-Reactive Protein,CRP ELISA Kit	96 Test	38220090	24,500.00
CLS0063BO	Bovine adiponectin,ADP ELISA Kit	96 Test	38220090	24,500.00
CLS0064BO	Bovine C-Peptide(C-Peptide)ELISA Kit	96 Test	38220090	24,500.00
CLS0065BO	Bovine Nuclear autoantigenic sperm protein,NASP ELISA KIT	96 Test	38220090	24,500.00
CLS0066BO	Bovine Interleukin 8,IL-8 ELISA Kit	96 Test	38220090	24,500.00
CLS0067BO	Bovine Interleukin 6,IL-6 ELISA Kit	96 Test	38220090	24,500.00
CLS0068BO	Bovine Prolactin(PRL)ELISA Kit	96 Test	38220090	24,500.00
CLS0069BO	Bovine soluble interleukin-2 receptor,IL-2sR β ELISA kit	96 Test	38220090	24,500.00
CLS0070BO	Bovine Dehydroepiandrosterone(DHEA)ELISA Kit	96 Test	38220090	24,500.00
CLS0071BO	Bovine melanocyte stimulating hormone α (α -MSH)ELISA Kit	96 Test	38220090	24,500.00
CLS0072BO	Bovine Follicle-stimulating hormone,FSH ELISA Kit	96 Test	38220090	24,500.00
CLS0073BO	Bovine Estrogen(E) ELISA Kit	96 Test	38220090	24,500.00
CLS0074BO	Bovine Melatonin (MT)ELISA Kit	96 Test	38220090	24,500.00
CLS0075BO	Bovine Metallothionein-2(MT-2) ELISA Kit	96 Test	38220090	24,500.00
CLS0076BO	Bovine Adrenocorticotrophic hormone(ACTH)ELISA Kit	96 Test	38220090	24,500.00
CLS0077BO	Bovine Tri-iodothyronine,T3 ELISA Kit	96 Test	38220090	24,500.00
CLS0078BO	Bovine Apelin,AP ELISA Kit	96 Test	38220090	24,500.00
CLS0079BO	Bovine Thyroxine,T4 ELISA Kit	96 Test	38220090	24,500.00

Cat.No.	Product Description	Pack Size	HSN	Unit Price
CLS0080BO	Bovine 13,14-dihydro-15-keto-prostaglandin F2-alpha(PGFM)ELISA Kit	96 Test	38220090	24,500.00
CLS0081BO	Bovine Toll-like receptor 4(TLR4)ELISA Kit	96 Test	38220090	24,500.00
CLS0082BO	Bovine Glycated Albumin(GA)ELISA Kit	96 Test	38220090	24,500.00
CLS0083BO	Bovine Leptin,LEP ELISA Kit	96 Test	38220090	24,500.00
CLS0084BO	Bovine Heat Shock Protein 70,HSP-70 ELISA Kit	96 Test	38220090	24,500.00
CLS0085BO	Bovine menbrane IgA(mlgA)ELISA Kit	96 Test	38220090	24,500.00
CLS0086BO	Bovine Nitric Oxide(NO)ELISA Kit	96 Test	38220090	24,500.00
CLS0087BO	Bovine Glutathione reductase(GR)ELISA kit	96 Test	38220090	24,500.00
CLS0088BO	Bovine Catalase (CAT)ELISA Kit	96 Test	38220090	24,500.00
CLS0089BO	Bovine Heat Shock Protein 60(HSP-60)ELISA Kit	96 Test	38220090	24,500.00
CLS0090BO	Bovine ferritin(FE)ELISA Kit	96 Test	38220090	24,500.00
CLS0091BO	Bovine Transferrin(TRF)ELISA Kit	96 Test	38220090	24,500.00
CLS0092BO	Bovine Immunoglobulin G,IgG ELISA Kit	96 Test	38220090	24,500.00
CLS0093BO	Bovine Complement fragment 5a,C5a ELISA Kit	96 Test	38220090	24,500.00
CLS0094BO	Bovine Interferon γ ,IFN- γ ELISA Kit	96 Test	38220090	24,500.00
CLS0095BO	Bovine Interleukin 10(IL-10)ELISA Kit	96 Test	38220090	24,500.00
CLS0096BO	Bovine Heat Shock Protein 90kDa Alpha A1 (HSP90aA1)ELISA kit	96 Test	38220090	24,500.00
CLS0097BO	Bovine Interleukin 17A,IL-17A ELISA Kit	96 Test	38220090	24,500.00
CLS0098BO	Bovine intestinal fatty acid binding protein,iFABP ELISA Kit	96 Test	38220090	24,500.00
CLS0099BO	Bovine Bone Morphogenetic Protein 7(BMP7)ELISA Kit	96 Test	38220090	24,500.00
CLS0100BO	Bovine D-Lactate Dehydrogenase(D-LDH)ELISA Kit	96 Test	38220090	24,500.00
CLS0101BO	Bovine L-Lactate Dehydrogenase(L-LDH)ELISA Kit	96 Test	38220090	24,500.00
CLS0102BO	Bovine Peripherin(PRP)ELISA Kit	96 Test	38220090	24,500.00
CLS0103BO	Bovine Gonadotropin-releasing hormone,GnRH ELISA Kit	96 Test	38220090	24,500.00
CLS0104BO	Bovine Cluster of differentiation(CD14)ELISA Kit	96 Test	38220090	24,500.00
CLS0105BO	Bovine Ghrelin(GHRL)ELISA Kit	96 Test	38220090	24,500.00
CLS0106BO	Bovine Lecithin Cholesterol Acyltransferase(LCAT)ELISA Kit	96 Test	38220090	24,500.00
CLS0107BO	Bovine Protein C(Protein C)ELISA Kit	96 Test	38220090	24,500.00
CLS0108BO	Bovine Glucagon,GC ELISA Kit	96 Test	38220090	24,500.00
CLS0109BO	Bovine Osteocalcin(OT)ELISA Kit	96 Test	38220090	24,500.00
CLS0110BO	Bovine Parathyroid hormone(PTH)ELISA Kit	96 Test	38220090	24,500.00
CLS0111BO	Bovine Gastrin-releasing peptide(GRP)ELISA Kit	96 Test	38220090	24,500.00
CLS0112BO	Bovine Bone alkaline phosphatase(BALP)ELISA Kit	96 Test	38220090	24,500.00
CLS0113BO	Bovine Tartrate Resistant Acid Phosphatase(TRAP)ELISA Kit	96 Test	38220090	24,500.00
CLS0114BO	Bovine Hydroxyproline(HYP)ELISA Kit	96 Test	38220090	24,500.00
CLS0115BO	Bovine Calcitonin(CT)ELISA Kit	96 Test	38220090	24,500.00
CLS0116BO	Bovine SWI/SNF-related matrix-associated actin- dependent regulator of chromatin subfamily C member 1(SMARCC1)ELISA Kit	96 Test	38220090	24,500.00
CLS0117BO	Bovine Protein Tyrosine Phosphatase Receptor Type T,PTPRT/LAR ELISA Kit	96 Test	38220090	24,500.00
CLS0118BO	Bovine src kinase associated phosphoprotein 2(SCAP2/PRAP)ELISA Kit	96 Test	38220090	24,500.00
CLS0119BO	Bovine Orexin A(Orexin A)ELISA Kit	96 Test	38220090	24,500.00
CLS0120BO	Bovine Orexin B(Orexin B)ELISA Kit	96 Test	38220090	24,500.00
CLS0121BO	Bovine Resistin(Retn) ELISA KIT	96 Test	38220090	24,500.00
CLS0122BO	Bovine α -Amylase(AMY)ELISA Kit	96 Test	38220090	24,500.00
CLS0123BO	Bovine β -Amylase(AMS/AMY)ELISA Kit	96 Test	38220090	24,500.00
CLS0124BO	Bovine Alanine Aminotransferase,ALT/GPT ELISA Kit	96 Test	38220090	24,500.00
CLS0125BO	Bovine Aspartate aminotransferase,AST ELISA Kit	96 Test	38220090	24,500.00
CLS0126BO	Bovine Immunoglobulin G2a(IgG2A)ELISA Kit	96 Test	38220090	24,500.00
CLS0127BO	Bovine C-telopeptide of type I collagen(CTX-I)ELISA Kit	96 Test	38220090	24,500.00
CLS0128BO	Bovine 2',5'Oligoadenylate Synthetase 1(OAS1)ELISA kit	96 Test	38220090	24,500.00
CLS0129BO	Bovine Orosomucoid 1,ORM1/ α 1-AGP ELISA Kit	96 Test	38220090	24,500.00

Cat.No.	Product Description	Pack Size	HSN	Unit Price
CLS0130BO	Bovine Cholic acid(CA)ELISA Kit	96 Test	38220090	24,500.00
CLS0131BO	Bovine α 1-microglobulin(α 1-MG)ELISA Kit	96 Test	38220090	24,500.00
CLS0132BO	Bovine Thyroid Stimulating Hormone,TSH ELISA Kit	96 Test	38220090	24,500.00
CLS0133BO	Bovine Sialic acid(SA)ELISA Kit	96 Test	38220090	24,500.00
CLS0134BO	Bovine Azurocidin/Heparin Binding Protein(AZU/HBP)ELISA Kit	96 Test	38220090	24,500.00
CLS0135BO	Bovine Growth hormone,GH ELISA Kit	96 Test	38220090	24,500.00
CLS0136BO	Bovine fatty acid binding protein,FABP4 ELISA Kit	96 Test	38220090	24,500.00
CLS0137BO	Bovine Cathepsin B,cath-B ELISA Kit	96 Test	38220090	24,500.00
CLS0138BO	Bovine Extracellular matrix metalloproteinase inducer(EMMPRN) ELISA kit	96 Test	38220090	24,500.00
CLS0139BO	Bovine Growth Differentiation Factor 8 (GDF8)ELISA kit	96 Test	38220090	24,500.00
CLS0140BO	Bovine Growth Differentiation Factor 9 (GDF9)ELISA kit	96 Test	38220090	24,500.00
CLS0141BO	Bovine Heat Shock Protein 90kDa Beta 1 (HSP90b1)ELISA kit	96 Test	38220090	24,500.00
CLS0142BO	Bovine Myostatin,MSTN ELISA Kit	96 Test	38220090	24,500.00
CLS0143BO	Bovine Heparanase,HPA ELISA kit	96 Test	38220090	24,500.00
CLS0144BO	Bovine dipeptidyl peptidase 4,DPP4 ELISA Kit	96 Test	38220090	24,500.00
CLS0145BO	Bovine Epithelial Cell Adhesion Molecule,Ep-CAM ELISA Kit	96 Test	38220090	24,500.00
CLS0146BO	Bovine Caldesmon,CALD1 ELISA Kit	96 Test	38220090	24,500.00
CLS0147BO	Bovine Vitamin E,VE ELISA Kit	96 Test	38220090	24,500.00
CLS0148BO	Bovine Vitamin B12,VB12 ELISA Kit	96 Test	38220090	24,500.00
CLS0149BO	Bovine tyrosine kinase with immunoglobulin-like and EGF-like domains 2,Tie-2 ELISA kit	96 Test	38220090	24,500.00
CLS0150BO	Bovine Angiopoietin 4,ANG-4 ELISA Kit	96 Test	38220090	24,500.00
CLS0151BO	Bovine Angiopoietin 1,ANG-1 ELISA Kit	96 Test	38220090	24,500.00
CLS0152BO	Bovine Angiopoietin 2,ANG-2 ELISA Kit	96 Test	38220090	24,500.00
CLS0153BO	Bovine Transforming Growth factor β 1,TGF- β 1 ELISA kit	96 Test	38220090	24,500.00
CLS0154BO	Bovine Histone deacetylase 1,HDAC1 ELISA KIT	96 Test	38220090	24,500.00
CLS0155BO	Bovine Histone deacetylase 8,HDAC8 ELISA KIT	96 Test	38220090	24,500.00
CLS0156BO	Bovine Follistatin,FS ELISA Kit	96 Test	38220090	24,500.00
CLS0157BO	Bovine Follistatin-related protein 3(FSTL3)ELISA Kit	96 Test	38220090	24,500.00
CLS0158BO	Bovine Sclerostin(SOST)ELISA Kit	96 Test	38220090	24,500.00
CLS0159BO	Bovine Alpha-Hemoglobin Stabilizing Protein (aHSP)ELISA kit	96 Test	38220090	24,500.00
CLS0160BO	Bovine desmogleins 1,Dsg-1 ELISA Kit	96 Test	38220090	24,500.00
CLS0161BO	Bovine tissue inhibitors of metalloproteinase 4,TIMP-4 ELISA Kit	96 Test	38220090	24,500.00
CLS0162BO	Bovine Transthyretin,TTR ELISA Kit	96 Test	38220090	24,500.00
CLS0163BO	Bovine Islet amyloid polypeptide,IAPP ELISA Kit	96 Test	38220090	24,500.00
CLS0164BO	Bovine Platelet-derived growth factor subunit A,PDGFA ELISA kit	96 Test	38220090	24,500.00
CLS0165BO	Bovine Platelet-Derived Growth Factor-BB,PDGF-BB ELISA kit	96 Test	38220090	24,500.00
CLS0166BO	Bovine Beclin1,BECN1 ELISA kit	96 Test	38220090	24,500.00
CLS0167BO	Bovine Reactive oxygen species modulator 1(ROMO1)ELISA Kit	96 Test	38220090	24,500.00
CLS0168BO	Bovine Lymphotoxin-alpha,LTA ELISA Kit	96 Test	38220090	24,500.00
CLS0169BO	Bovine Bactericidal permeability-increasing protein,BPI ELISA Kit	96 Test	38220090	24,500.00
CLS0170BO	Bovine Secretin(SCT) ELISA Kit	96 Test	38220090	24,500.00
CLS0171BO	Bovine Thyroglobulin,TG ELISA Kit	96 Test	38220090	24,500.00
CLS0172BO	Bovine cytochrome P450 2E1,CYP2E1 ELISA Kit	96 Test	38220090	24,500.00
CLS0173BO	Bovine S100 Calcium Binding Protein A12 ,S100A12 ELISA Kit	96 Test	38220090	24,500.00
CLS0174BO	Bovine Dihydrotestosterone,DHT ELISA Kit	96 Test	38220090	24,500.00
CLS0175BO	Bovine 17-Hydroxyprogesterone,17-OHP ELISA Kit	96 Test	38220090	24,500.00
CLS0176BO	Bovine Angiotensin converting enzyme,ACE ELISA Kit	96 Test	38220090	24,500.00

Cat.No.	Product Description	Pack Size	HSN	Unit Price
CLS0177BO	Bovine farnesyl-diphosphate farnesyltransferase 1,FDFT1 ELISA Kit	96 Test	38220090	24,500.00
CLS0178BO	Bovine sorbitol dehydrogenase,SDH ELISA Kit	96 Test	38220090	24,500.00
CLS0179BO	Bovine Cytochrome P450 19A1,CYP19A1 ELISA Kit	96 Test	38220090	24,500.00
CLS0180BO	Bovine Steroid 17-alpha-hydroxylase/17,20 lyase;Cytochrome P450 17A1,CYP17A1 ELISA Kit	96 Test	38220090	24,500.00
CLS0181BO	Bovine Zinc finger matrin-type protein 3(ZMAT3)ELISA Kit	96 Test	38220090	24,500.00
CLS0182BO	Bovine Glucose dependent insulin releasing polypeptide,GIP ELISA Kit	96 Test	38220090	24,500.00
CLS0183BO	Bovine DNA repair protein RAD51 homolog 1(RAD51) ELISA Kit	96 Test	38220090	24,500.00
CLS0184BO	Bovine Apolipoprotein H/Beta-2-glycoprotein 1,Apo-H ELISA Kit	96 Test	38220090	24,500.00
CLS0185BO	Bovine Hormone sensitive lipase(HSL)ELISA Kit	96 Test	38220090	24,500.00
CLS0186BO	Bovine Troponin T, slow skeletal muscle(TNNT1) ELISA Kit	96 Test	38220090	24,500.00
CLS0187BO	Bovine Troponin T, slow skeletal muscle(TNNT3) ELISA Kit	96 Test	38220090	24,500.00
CLS0188BO	Bovine cardiac troponin I ,cTn- I ELISA Kit	96 Test	38220090	24,500.00
CLS0189BO	Bovine Histidine-proline-rich glycoprotein(HPRG) ELISA Kit	96 Test	38220090	24,500.00
CLS0190BO	Bovine Receptor for advanced glycation end products, RAGE/AGER ELISA Kit	96 Test	38220090	24,500.00
CLS0191BO	Bovine Thyroxine-Binding Globulin,TBG ELISA Kit	96 Test	38220090	24,500.00
CLS0192BO	Bovine Pancreatic Polypeptide,PP ELISA Kit	96 Test	38220090	24,500.00
CLS0193BO	Bovine proteolipid protein,PLP ELISA Kit	96 Test	38220090	24,500.00
CLS0194BO	Bovine Sialidase-1,NEU1 ELISA Kit	96 Test	38220090	24,500.00
CLS0195BO	Bovine Sialidase-3,NEU3 ELISA Kit	96 Test	38220090	24,500.00
CLS0196BO	Bovine high mobility group protein 17,HMG-17 ELISA Kit	96 Test	38220090	24,500.00
CLS0197BO	Bovine Vascular Endothelial cell Growth Factor A,VEGF-A ELISA KIT	96 Test	38220090	24,500.00
CLS0198BO	Bovine Interleukin 21,IL-21 ELISA Kit	96 Test	38220090	24,500.00
CLS0199BO	Bovine Leukotriene B4 receptor 1,LTB4R ELISA Kit	96 Test	38220090	24,500.00
CLS0200BO	Bovine latent transforming growth factor beta binding protein 2,LTBP2 ELISA Kit	96 Test	38220090	24,500.00
CLS0201BO	Bovine Prostaglandin reductase 1,PTGR1 ELISA Kit	96 Test	38220090	24,500.00
CLS0202BO	Bovine Clathrin light chain B,CLTB ELISA Kit	96 Test	38220090	24,500.00
CLS0203BO	Bovine Clathrin light chain A,CLTA ELISA Kit	96 Test	38220090	24,500.00
CLS0204BO	Bovine ficolin 2,FCN2 ELISA Kit	96 Test	38220090	24,500.00
CLS0205BO	Bovine secreted protein acidic and rich in cysteine,SPARC ELISA Kit	96 Test	38220090	24,500.00
CLS0206BO	Bovine Beta-defensin 1,DEFB1 ELISA kit	96 Test	38220090	24,500.00
CLS0207BO	Bovine Beta-defensin 3,DEFB3 ELISA kit	96 Test	38220090	24,500.00
CLS0208BO	Bovine Beta-defensin 2,DEFB2 ELISA kit	96 Test	38220090	24,500.00
CLS0209BO	Bovine Galanin,GAL ELISA Kit	96 Test	38220090	24,500.00
CLS0210BO	Bovine Apolipoprotein O,Apo-O ELISA Kit	96 Test	38220090	24,500.00
CLS0211BO	Bovine Tumor necrosis factor receptor superfamily member 5,CD40/TNFRSF5 ELISA Kit	96 Test	38220090	24,500.00
CLS0212BO	Bovine Undercarboxylated Osteocalcin (ucOC) ELISA Kit	96 Test	38220090	24,500.00
CLS0213BO	Bovine Ornithine decarboxylase,ODC1 ELISA Kit	96 Test	38220090	24,500.00
CLS0214BO	Bovine Neopterin(NEOP) ELISA Kit	96 Test	38220090	24,500.00
CLS0215BO	Bovine Endothelin 1,ET-1 ELISA Kit	96 Test	38220090	24,500.00
CLS0216BO	Bovine Endothelin-1 receptor,EDNRA ELISA Kit	96 Test	38220090	24,500.00
CLS0217BO	Bovine Hyaluronan synthase 2,HAS2 ELISA Kit	96 Test	38220090	24,500.00
CLS0218BO	Bovine Lymphatic vessel endothelial hyaluronic acid receptor 1(LYVE-1) ELISA Kit	96 Test	38220090	24,500.00
CLS0219BO	Bovine Protease Activated Receptor 1(PAR1) ELISA Kit	96 Test	38220090	24,500.00
CLS0220BO	Bovine Protease Activated Receptor 2(PAR2) ELISA Kit	96 Test	38220090	24,500.00
CLS0221BO	Bovine Protease Activated Receptor 3(PAR3) ELISA Kit	96 Test	38220090	24,500.00

Cat.No.	Product Description	Pack Size	HSN	Unit Price
CLS0222BO	Bovine Thymidine kinase, cytosolic(TK1) ELISA Kit	96 Test	38220090	24,500.00
CLS0223BO	Bovine Angiotensin converting enzyme 2,ACE2 ELISA Kit	96 Test	38220090	24,500.00
CLS0224BO	Bovine Acetyl-Coa Carboxylase1(ACC1) ELISA Kit	96 Test	38220090	24,500.00
CLS0225BO	Bovine Atrial natriuretic peptide receptor 2,NPR2 ELISA kit	96 Test	38220090	24,500.00
CLS0226BO	Bovine Atrial natriuretic peptide receptor 3,NPR3 ELISA kit	96 Test	38220090	24,500.00
CLS0227BO	Bovine SPRY domain-containing SOCS box protein 1,SPSB1 ELISA kit	96 Test	38220090	24,500.00
CLS0228BO	Bovine SPRY domain-containing SOCS box protein 3,SPSB3 ELISA kit	96 Test	38220090	24,500.00
CLS0229BO	Bovine Non-histone chromosomal protein HMG-14,HMG14 ELISA kit	96 Test	38220090	24,500.00
CLS0230BO	Bovine Fructose-1,6-bisphosphatase 1,FBP1 ELISA kit	96 Test	38220090	24,500.00
CLS0231BO	Bovine Serum response factor-binding protein 1,SRFBP1 ELISA kit	96 Test	38220090	24,500.00
CLS0232BO	Bovine Fibroblast growth factor-binding protein 1,FGFBP1 ELISA kit	96 Test	38220090	24,500.00
CLS0233BO	Bovine 6-phosphofructo-2-kinase/fructose-2,6-biphosphatase 1,PFKFB1 ELISA kit	96 Test	38220090	24,500.00
CLS0234BO	Bovine 6-phosphofructo-2-kinase/fructose-2,6-biphosphatase 2,PFKFB2 ELISA kit	96 Test	38220090	24,500.00
CLS0235BO	Bovine Platelet Factor 4,PF-4 ELISA Kit	96 Test	38220090	24,500.00
CLS0236BO	Bovine Glycogen synthase,GYS/GYS1 ELISA Kit	96 Test	38220090	24,500.00
CLS0237BO	Bovine Tubulin polymerization-promoting protein,TPPP ELISA Kit	96 Test	38220090	24,500.00
CLS0238BO	Bovine Tubulin polymerization-promoting protein family member 2,TPPP2 ELISA Kit	96 Test	38220090	24,500.00
CLS0239BO	Bovine Tubulin polymerization-promoting protein family member 3,TPPP3 ELISA Kit	96 Test	38220090	24,500.00
CLS0240BO	Bovine Pulmonary surfatcant-associated protein A,SP-A ELISA Kit	96 Test	38220090	24,500.00
CLS0241BO	Bovine Pulmonary surfatcant-associated protein D,SP-D ELISA Kit	96 Test	38220090	24,500.00
CLS0242BO	Bovine Pulmonary surfatcant-associated protein B,SP-B ELISA Kit	96 Test	38220090	24,500.00
CLS0243BO	Bovine Pulmonary surfatcant-associated protein C,SP-C ELISA Kit	96 Test	38220090	24,500.00
CLS0244BO	Bovine Phosphofructokinase,PFK ELISA Kit	96 Test	38220090	24,500.00
CLS0245BO	Bovine 6-phosphofructokinase, liver type(PFKL)ELISA kit	96 Test	38220090	24,500.00
CLS0246BO	Bovine granulocyte chemotactic protein-2,GCP-2 ELISA Kit	96 Test	38220090	24,500.00
CLS0247BO	Bovine polymeric immunoglobulin receptor/secretory component,PIGR/SC ELISA Kit	96 Test	38220090	24,500.00
CLS0248BO	Bovine G1/S-specific Cyclin-D1,Cyclin-D1 ELISA Kit	96 Test	38220090	24,500.00
CLS0249BO	Bovine Endothelin-converting enzyme 1,ECE1 ELISA Kit	96 Test	38220090	24,500.00
CLS0250BO	Bovine Tripartite motif-containing protein 21,TRIM21/RNF81 ELISA Kit	96 Test	38220090	24,500.00
CLS0251BO	Bovine Breast cancer susceptibility protein 1,BRCA-1 ELISA Kit	96 Test	38220090	24,500.00
CLS0252BO	Bovine Lys-63-specific deubiquitinase BRCC36,BRCC3/BRCC36 ELISA Kit	96 Test	38220090	24,500.00
CLS0253BO	Bovine Myo-inositol oxygenase,MIOX ELISA Kit	96 Test	38220090	24,500.00
CLS0254BO	Bovine Gonadotropin-releasing hormone receptor,GnRHR ELISA Kit	96 Test	38220090	24,500.00
CLS0255BO	Bovine Collagen type I alpha 2,COL1A2/Collagen I ELISA Kit	96 Test	38220090	24,500.00
CLS0256BO	Bovine Collagen alpha-1(IV) chain,COL4A1/Collagen IV ELISA Kit	96 Test	38220090	24,500.00
CLS0257BO	Bovine Vascular adhesion protein-1,VAP-1/AOC3 ELISA Kit	96 Test	38220090	24,500.00

Cat.No.	Product Description	Pack Size	HSN	Unit Price
CLS0258BO	Bovine Zinc finger CCCH domain-containing protein 15,ZC3H15 ELISA Kit	96 Test	38220090	24,500.00
CLS0259BO	Bovine Potassium channel subfamily K member 1,KCNK1 ELISA Kit	96 Test	38220090	24,500.00
CLS0260BO	Bovine Vitamin D-binding protein,DBP ELISA Kit	96 Test	38220090	24,500.00
CLS0261BO	Bovine ATP-sensitive inward rectifier potassium channel 12,KCNJ12/Kir2.2 ELISA Kit	96 Test	38220090	24,500.00
CLS0262BO	Bovine Inward rectifier potassium channel 2,KCNJ2 ELISA Kit	96 Test	38220090	24,500.00
CLS0263BO	Bovine Deoxyribonuclease 1, DNase-1 ELISA Kit	96 Test	38220090	24,500.00
CLS0264BO	Bovine Deoxyribonuclease-2-alpha, DNASE2A ELISA Kit	96 Test	38220090	24,500.00
CLS0265BO	Bovine phosphoenolpyruvate carboxykinase, PCK ELISA Kit	96 Test	38220090	24,500.00
CLS0266BO	Bovine Deoxyribonuclease-1-like 1, DNASE1L1 ELISA Kit	96 Test	38220090	24,500.00
CLS0267BO	Bovine Isocitrate dehydrogenase [NADP] cytoplasmic(IDH1) ELISA Kit	96 Test	38220090	24,500.00
CLS0268BO	Bovine Isocitrate dehydrogenase [NADP] mitochondrial(IDH2) ELISA Kit	96 Test	38220090	24,500.00
CLS0269BO	Bovine Perilipin-2(PLIN2)ELISA kit	96 Test	38220090	24,500.00
CLS0270BO	Bovine Oxidized low-density lipoprotein receptor 1, OLR1/LOX1 ELISA kit	96 Test	38220090	24,500.00
CLS0271BO	Bovine CXC-chemokine receptor 4, CXCR4 ELISA Kit	96 Test	38220090	24,500.00
CLS0272BO	Bovine Acetylcholinesterase, AChE ELISA Kit	96 Test	38220090	24,500.00
CLS0273BO	Bovine Lysyl oxidase-like protein 1, LOXL1 ELISA kit	96 Test	38220090	24,500.00
CLS0274BO	Bovine Mesencephalic astrocyte-derived neurotrophic factor, MANF ELISA Kit	96 Test	38220090	24,500.00
CLS0275BO	Bovine S100 calcium binding protein A8/calgranulin A, S100A8 ELISA Kit	96 Test	38220090	24,500.00
CLS0276BO	Bovine S100 calcium binding protein A9/calgranulin B, S100A9 ELISA Kit	96 Test	38220090	24,500.00
CLS0277BO	Bovine Nuclear factor erythroid 2-related factor 2, NRF2 ELISA kit	96 Test	38220090	24,500.00
CLS0278BO	Bovine Hemopexin, HPX ELISA kit	96 Test	38220090	24,500.00
CLS0279BO	Bovine Selenide, water dikinase 1, SEPHS1 ELISA kit	96 Test	38220090	24,500.00
CLS0280BO	Bovine Selenium-binding protein 1, SELENBP1 ELISA kit	96 Test	38220090	24,500.00
CLS0281BO	Bovine Glucose transporter 1, GLUT1/SLC2A1 ELISA Kit	96 Test	38220090	24,500.00
CLS0282BO	Bovine Glutamate oxaloacetate transaminase 1, GOT1 ELISA Kit	96 Test	38220090	24,500.00
CLS0283BO	Bovine Fibrillin-1, FBN1 ELISA Kit	96 Test	38220090	24,500.00
CLS0284BO	Bovine TGF-beta receptor type-1, TGFBR1 ELISA Kit	96 Test	38220090	24,500.00
CLS0285BO	Bovine Transcription factor GATA-5, GATA5 ELISA Kit	96 Test	38220090	24,500.00
CLS0286BO	Bovine Interferon alpha, IFN-alpha ELISA Kit	96 Test	38220090	24,500.00
CLS0287BO	Bovine Interferon beta, IFN-beta/IFNB ELISA Kit	96 Test	38220090	24,500.00
CLS0288BO	Bovine Kininogen-1, KNG1/HMWK ELISA Kit	96 Test	38220090	24,500.00
CLS0289BO	Bovine Acid Phosphatase(ACP) ELISA Kit	96 Test	38220090	24,500.00
CLS0290BO	Bovine alkaline phosphatase, ALP ELISA Kit	96 Test	38220090	24,500.00
CLS0291BO	Bovine Total protein S, TPS ELISA Kit	96 Test	38220090	24,500.00
CLS0292BO	Bovine Total protein C, TPC ELISA Kit	96 Test	38220090	24,500.00
CLS0293BO	Bovine Anti Mullerian Hormone(AMH)ELISA Kit	96 Test	38220090	24,500.00
CLS0294BO	Bovine Interferon tau(IFN-tau)ELISA Kit	96 Test	38220090	24,500.00
CLS0295BO	Bovine Viral Diarrhoea(VD)ELISA Kit	96 Test	38220090	24,500.00
CLS0296BO	Bovine Heat Shock Protein 90, HSP-90 ELISA Kit	96 Test	38220090	24,500.00
CLS0297BO	Bovine Integrin alphaM, ITG/CD11b ELISA Kit	96 Test	38220090	24,500.00
CLS0298BO	Bovine Growth Hormone Releasing Peptide, GHRP ELISA Kit	96 Test	38220090	24,500.00
CLS0299BO	Bovine mitogen activated protein kinase1, MAPK1/MAPK ELISA Kit	96 Test	38220090	24,500.00
CLS0300BO	Bovine Calpastatin/Calpain inhibitor, CAST ELISA Kit	96 Test	38220090	24,500.00

Cat.No.	Product Description	Pack Size	HSN	Unit Price
CLS0301BO	Bovine Phosphatidylinositol N- acetylglucosaminyltransferase subunit Y,PIGY ELISA Kit	96 Test	38220090	24,500.00
CLS0302BO	Bovine Glucose-6-phosphate isomerase,GPI ELISA Kit	96 Test	38220090	24,500.00
CLS0303BO	Bovine Retinal dehydrogenase 1,ALDH1A1 ELISA Kit	96 Test	38220090	24,500.00
CLS0304BO	Bovine Gastrin,GAS ELISA Kit	96 Test	38220090	24,500.00
CLS0305BO	Bovine Synuclein-gamma,SNCG ELISA Kit	96 Test	38220090	24,500.00
CLS0306BO	Bovine secretory immunoglobulin A,SIgA ELISA Kit	96 Test	38220090	24,500.00
CLS0307BO	Bovine Alpha-Synuclein,SNCA ELISA Kit	96 Test	38220090	24,500.00
CLS0308BO	Bovine Complement factor D/Adipsin,CFD ELISA Kit	96 Test	38220090	24,500.00
CLS0309BO	Bovine Gelsolin,GS ELISA Kit	96 Test	38220090	24,500.00
CLS0310BO	Bovine Fibrinogen-like protein 1,FGL1 ELISA Kit	96 Test	38220090	24,500.00
CLS0311BO	Bovine Transglutaminase-3,TGM3 ELISA Kit	96 Test	38220090	24,500.00
CLS0312BO	Bovine Alpha-1B-glycoprotein,A1BG ELISA Kit	96 Test	38220090	24,500.00
CLS0313BO	Bovine Fibronectin,FN ELISA Kit	96 Test	38220090	24,500.00
CLS0314BO	Bovine Fetuin B,FETU-B ELISA Kit	96 Test	38220090	24,500.00
CLS0315BO	Bovine Fetuin A,FETU-A ELISA Kit	96 Test	38220090	24,500.00
CLS0316BO	Bovine Estrogen Receptor beta,ER-beta ELISA Kit	96 Test	38220090	24,500.00
CLS0317BO	Bovine Vascular Endothelial cell Growth Factor B,VEGF-B ELISA KIT	96 Test	38220090	24,500.00
CLS0318BO	Bovine Annexin A3 (ANXA3)ELISA Kit	96 Test	38220090	24,500.00
CLS0319BO	Bovine Annexin A6 (ANXA6)ELISA Kit	96 Test	38220090	24,500.00
CLS0320BO	Bovine Annexin A4 (ANXA4)ELISA Kit	96 Test	38220090	24,500.00
CLS0321BO	Bovine F-box only protein 32,FBXO32/MAFbx ELISA Kit	96 Test	38220090	24,500.00
CLS0322BO	Bovine Telomerase reverse transcriptase, TERT ELISA Kit	96 Test	38220090	24,500.00
CLS0323BO	Bovine Cysteinyl aspartate specific proteinases 3,Caspase-3/ CPP32 ELISA Kit	96 Test	38220090	24,500.00
CLS0324BO	Bovine cholesterol,CH ELISA Kit	96 Test	38220090	24,500.00
CLS0325BO	Bovine Urea elisa kit	96 Test	38220090	24,500.00
CLS0325CT	Cat N-terminal pro-brain natriuretic peptide,NT-proBNP ELISA KIT	96 Test	38220090	24,500.00
CLS0326CT	Cat Free Thyroxine,FT4 ELISA Kit	96 Test	38220090	24,500.00
CLS0327CT	Cat C-telopeptide of type I collagen,CTX- I ELISA Kit	96 Test	38220090	24,500.00
CLS0328CT	Cat Bone specific alkaline phosphatase,BAP ELISA Kit	96 Test	38220090	24,500.00
CLS0329CT	Cat procollagen I N-terminal peptide,P I NP ELISA Kit	96 Test	38220090	24,500.00
CLS0330CT	Cat Immunoglobulin G(IgG)ELISA Kit	96 Test	38220090	24,500.00
CLS0331CT	Cat Neutrophil Gelatinase-Associated Lipocalin(NGAL)ELISA Kit	96 Test	38220090	24,500.00
CLS0001CA	Canine symmetric dimethylarginine(SDMA)ELISA Kit	96 Test	38220090	24,500.00
CLS0002CA	Canine Beta-2 microglobulin(B2-MG)ELISA Kit	96 Test	38220090	24,500.00
CLS0003CA	Canine Fibrinogen,Fbg ELISA Kit	96 Test	38220090	24,500.00
CLS0004CA	Canine Microalbumin(MALB)ELISA Kit	96 Test	38220090	24,500.00
CLS0005CA	Canine N-terminal pro-brain natriuretic peptide,NT-proBNP ELISA Kit	96 Test	38220090	24,500.00
CLS0006CA	Canine Growth hormone,GH ELISA Kit	96 Test	38220090	24,500.00
CLS0007CA	Canine insulin-like growth factors 1(IGF-1)ELISA Kit	96 Test	38220090	24,500.00
CLS0008CA	Canine Thyroxine(T4)ELISA Kit	96 Test	38220090	24,500.00
CLS0009CA	Canine Prolactin,PRL ELISA Kit	96 Test	38220090	24,500.00
CLS0010CA	Canine Insulin,INS ELISA Kit	96 Test	38220090	24,500.00
CLS0011CA	Canine basic fibroblast growth factor 2(bFGF2)ELISA Kit	96 Test	38220090	24,500.00
CLS0012CA	Canine Vascular Endothelial cell Growth Factor,VEGF ELISA Kit	96 Test	38220090	24,500.00
CLS0013CA	Canine Transforming Growth Factor β (TGF- β)ELISA Kit	96 Test	38220090	24,500.00
CLS0014CA	Canine platelet-derived growth factor(PDGF)ELISA Kit	96 Test	38220090	24,500.00
CLS0015CA	Canine Carbohydrate Antigen 15-3 (CA15-3)ELISA kit	96 Test	38220090	24,500.00
CLS0016CA	Canine Carcinoembryonic Antigen(CEA)ELISA Kit	96 Test	38220090	24,500.00
CLS0017CA	Canine non-ester fatty acid(NEFA)ELISA Kit	96 Test	38220090	24,500.00
CLS0018CA	Canine transferrin receptor,TFR ELISA Kit	96 Test	38220090	24,500.00
CLS0019CA	Canine Coenzyme Q10(CoQ10)ELISA Kit	96 Test	38220090	24,500.00
CLS0020CA	Canine Total protein S(TPS)ELISA Kit	96 Test	38220090	24,500.00

Cat.No.	Product Description	Pack Size	HSN	Unit Price
CLS0021CA	Canine Creatinine(Cr)ELISA Kit	96 Test	38220090	24,500.00
CLS0022CA	Canine beta-2-microglobulin (B2M) ELISA kit	96 Test	38220090	24,500.00
CLS0023CA	Canine Liver Type Fatty Acid Binding Protein(L-FABP)ELISA Kit	96 Test	38220090	24,500.00
CLS0024CA	Canine Fibroblast growth factor-23(FGF-23)ELISA Kit	96 Test	38220090	24,500.00
CLS0025CA	Canine N-acetyl-β-D-glucosaminidase(NAG)ELISA Kit	96 Test	38220090	24,500.00
CLS0026CA	Canine Asymmetrical dimethylarginine,ADMA ELISA Kit	96 Test	38220090	24,500.00
CLS0027CA	Canine Thyroid Stimulating Hormone(TSH)ELISA Kit	96 Test	38220090	24,500.00
CLS0028CA	Canine Methemoglobin(MHB)ELISA Kit	96 Test	38220090	24,500.00
CLS0029CA	Canine Amyloid beta peptide 1-42(Aβ1-42)ELISA Kit	96 Test	38220090	24,500.00
CLS0030CA	Canine Amyloid beta peptide 1-40(Aβ1-40)ELISA Kit	96 Test	38220090	24,500.00
CLS0031CA	Canine Luteinizing Hormone,LH ELISA Kit	96 Test	38220090	24,500.00
CLS0032CA	Canine Tumor necrosis factor α,TNF-α ELISA Kit	96 Test	38220090	24,500.00
CLS0033CA	Canine Interleukin 8,IL-8 ELISA Kit	96 Test	38220090	24,500.00
CLS0034CA	Canine Neutrophil elastase,NE ELISA Kit	96 Test	38220090	24,500.00
CLS0035CA	Canine Interleukin 1β,IL-1β ELISA Kit	96 Test	38220090	24,500.00
CLS0036CA	Canine Interleukin 4,IL-4 ELISA Kit	96 Test	38220090	24,500.00
CLS0037CA	Canine Interleukin 6,IL-6 ELISA Kit	96 Test	38220090	24,500.00
CLS0038CA	Canine Interleukin 10,IL-10 ELISA Kit	96 Test	38220090	24,500.00
CLS0039CA	Canine Transforming Growth factor β1,TGF-β1 ELISA kit	96 Test	38220090	24,500.00
CLS0040CA	Canine cyclooxygenase-2(COX-2)ELISA Kit	96 Test	38220090	24,500.00
CLS0041CA	Canine Mullerian Inhibiting Substance/Anti-Mullerian hormone,MIS/AMH ELISA Kit	96 Test	38220090	24,500.00
CLS0042CA	Canine Angiopoietin 1,ANG-1 ELISA Kit	96 Test	38220090	24,500.00
CLS0043CA	Canine Angiopoietin 2,ANG-2 ELISA Kit	96 Test	38220090	24,500.00
CLS0044CA	Canine Plasminogen activator inhibitor 1,PAI-1 ELISA Kit	96 Test	38220090	24,500.00
CLS0045CA	Canine S100 Calcium Binding Protein A12,S100A12 ELISA Kit	96 Test	38220090	24,500.00
CLS0046CA	Canine Glutathione Reductase(GR)ELISA Kit	96 Test	38220090	24,500.00
CLS0047CA	Canine Cystatin C(Cys-C)ELISA Kit	96 Test	38220090	24,500.00
CLS0048CA	Canine kidney injury molecule 1(Kim-1)ELISA Kit	96 Test	38220090	24,500.00
CLS0049CA	Canine Osteocalcin(OT)ELISA Kit	96 Test	38220090	24,500.00
CLS0050CA	Canine C-Peptide(C-P)ELISA Kit	96 Test	38220090	24,500.00
CLS0051CA	Canine malondialdehyde(MDA)ELISA Kit	96 Test	38220090	24,500.00
CLS0052CA	Canine Glutathione peroxidase 1(GPx-1)ELISA Kit	96 Test	38220090	24,500.00
CLS0053CA	Canine Homocysteine(HCY)ELISA Kit	96 Test	38220090	24,500.00
CLS0054CA	Canine Nesfatin 1(NES1)ELISA Kit	96 Test	38220090	24,500.00
CLS0055CA	Canine Carboxyterminal propeptide of type I procollagen(P I CP)ELISA Kit	96 Test	38220090	24,500.00
CLS0056CA	Canine Cluster of differentiation(CD14)ELISA Kit	96 Test	38220090	24,500.00
CLS0057CA	Canine Cluster of differentiation 3(CD3)ELISA Kit	96 Test	38220090	24,500.00
CLS0058CA	Canine Interleukin 3(IL-3)ELISA Kit	96 Test	38220090	24,500.00
CLS0059CA	Canine Chitinase-3-like Protein 1(YKL-40,CHI3L1)ELISA Kit	96 Test	38220090	24,500.00
CLS0060CA	Canine Thiobarbituric acid reactive substances,TBARS ELISA Kit	96 Test	38220090	24,500.00
CLS0061CA	Canine monocyte chemotactic protein 1,monocyte chemotactic and activating factor(MCP-1/CCL2/MCAF)ELISA Kit	96 Test	38220090	24,500.00
CLS0062CA	Canine Granulocyte-Macrophage Colony Stimulating Factor(GM-CSF)ELISA Kit	96 Test	38220090	24,500.00
CLS0063CA	Canine Free Thyroxine,FT4 ELISA Kit	96 Test	38220090	24,500.00
CLS0064CA	Canine Superoxide Dismutase(SOD)ELISA Kit	96 Test	38220090	24,500.00
CLS0065CA	Canine Catalase (CAT)ELISA Kit	96 Test	38220090	24,500.00
CLS0066CA	Canine High Sensitivity C-Reactive Protein(HS-CRP)ELISA Kit	96 Test	38220090	24,500.00
CLS0067CA	Canine Thrombomodulin, TM ELISA Kit	96 Test	38220090	24,500.00
CLS0068CA	Canine Thrombus precursor protein, TpP ELISA Kit	96 Test	38220090	24,500.00

Cat.No.	Product Description	Pack Size	HSN	Unit Price
CLS0069CA	Canine Tissue factor pathway inhibitor,TFPI ELISA Kit	96 Test	38220090	24,500.00
CLS0070CA	Canine Tissue factor,IF ELISA Kit	96 Test	38220090	24,500.00
CLS0071CA	Canine Tri-iodothyronine(T3)ELISA Kit	96 Test	38220090	24,500.00
CLS0072CA	Canine Vascular endothelial cell adhesion molecule-1,VCAM-1/CD106 ELISA Kit	96 Test	38220090	24,500.00
CLS0073CA	Canine Vascular cell adhesion molecule 1,VCAM-1 ELISA Kit	96 Test	38220090	24,500.00
CLS0074CA	Canine Von Willebrand Factor,vWF ELISA Kit	96 Test	38220090	24,500.00
CLS0075CA	Canine zonula occludens-1,ZO-1 ELISA Kit	96 Test	38220090	24,500.00
CLS0076CA	Canine Caveolin-1,Cav-1 ELISA Kit	96 Test	38220090	24,500.00
CLS0077CA	Canine Endothelin 1,ET-1 ELISA Kit	96 Test	38220090	24,500.00
CLS0078CA	Canine Ghrelin(GHRL) ELISA Kit	96 Test	38220090	24,500.00
CLS0079CA	Canine Glycated hemoglobin A1c,GHbA1c ELISA Kit	96 Test	38220090	24,500.00
CLS0080CA	Canine Histamine,HIS ELISA Kit	96 Test	38220090	24,500.00
CLS0081CA	Canine Insulin Receptor,INSR ELISA Kit	96 Test	38220090	24,500.00
CLS0082CA	Canine Intercellular adhesion molecule 1,ICAM-1 ELISA Kit	96 Test	38220090	24,500.00
CLS0083CA	Canine Interferon γ ,IFN- γ ELISA Kit	96 Test	38220090	24,500.00
CLS0084CA	Canine Interleukin 1,IL-1 ELISA Kit	96 Test	38220090	24,500.00
CLS0085CA	Canine Interleukin 17,IL-17 ELISA Kit	96 Test	38220090	24,500.00
CLS0086CA	Canine Leptin,LEP ELISA Kit	96 Test	38220090	24,500.00
CLS0087CA	Canine Norepinephrine,NE ELISA Kit	96 Test	38220090	24,500.00
CLS0088CA	Canine Occludin 1, ELISA Kit	96 Test	38220090	24,500.00
CLS0089CA	Canine Brain natriuretic peptide,BNP ELISA Kit	96 Test	38220090	24,500.00
CLS0090CA	Canine Protein kinase C,PKC ELISA Kit	96 Test	38220090	24,500.00
CLS0091CA	Canine Prothrombin fragment 1+2,F1+2 ELISA Kit	96 Test	38220090	24,500.00
CLS0092CA	Canine Rho-associated coiled-coil containing protein kinase 2,Rock-2 ELISA Kit	96 Test	38220090	24,500.00
CLS0093CA	Canine Sorbitol dehydrogenase(SDH) ELISA Kit	96 Test	38220090	24,500.00
CLS0094CA	Canine adrenomedullin(ADM)ELISA Kit	96 Test	38220090	24,500.00
CLS0095CA	Canine Alpha-1B-glycoprotein,A1BG ELISA Kit	96 Test	38220090	24,500.00
CLS0096CA	Canine B cell activating factor of TNF family(BAFF)ELISA Kit	96 Test	38220090	24,500.00
CLS0097CA	Canine CD5 antigen-like,CD5L ELISA Kit	96 Test	38220090	24,500.00
CLS0098CA	Canine cluster of differentiation 8,CD8 ELISA Kit	96 Test	38220090	24,500.00
CLS0099CA	Canine cluster Of differentiation,CD4 ELISA Kit	96 Test	38220090	24,500.00
CLS0100CA	Canine Complement fragment 5a,C5a ELISA Kit	96 Test	38220090	24,500.00
CLS0101CA	Canine Cortisol(COR) ELISA Kit	96 Test	38220090	24,500.00
CLS0102CA	Canine C-Reactive Protein,CRP ELISA Kit	96 Test	38220090	24,500.00
CLS0103CA	Canine ferritin(FE)ELISA Kit	96 Test	38220090	24,500.00
CLS0104CA	Canine Fibronectin,FN ELISA Kit	96 Test	38220090	24,500.00
CLS0105CA	Canine Hecpudin(Hepc)ELISA Kit	96 Test	38220090	24,500.00
CLS0106CA	Canine Interleukin 21,IL-21 ELISA Kit	96 Test	38220090	24,500.00
CLS0107CA	Canine Interleukin 22,IL-22 ELISA kit	96 Test	38220090	24,500.00
CLS0108CA	Canine Luteinizing Hormone,LH ELISA Kit	96 Test	38220090	24,500.00
CLS0109CA	Canine Nesfatin(NES)ELISA Kit	96 Test	38220090	24,500.00
CLS0110CA	Canine neutrophil gelatinase-associated lipocalin,NGAL ELISA Kit	96 Test	38220090	24,500.00
CLS0111CA	Canine Osteoprotegerin(OPG)ELISA Kit	96 Test	38220090	24,500.00
CLS0112CA	Canine Paraoxonase-1(PON1)ELISA Kit	96 Test	38220090	24,500.00
CLS0113CA	Canine Platelet Factor 4,PF-4 ELISA Kit	96 Test	38220090	24,500.00
CLS0114CA	Canine Progesterone,PROG ELISA Kit	96 Test	38220090	24,500.00
CLS0115CA	Canine Serum amyloid A,SAA ELISA Kit	96 Test	38220090	24,500.00
CLS0116CA	Canine Total Homocystein(HCY)ELISA Kit	96 Test	38220090	24,500.00
CLS0117CA	Canine Troponin I ,Tn- I ELISA Kit	96 Test	38220090	24,500.00
CLS0118CA	Canine vitronectin,VNR ELISA Kit	96 Test	38220090	24,500.00
CLS0119CA	Canine pro-brain natriuretic peptide(PRO-BNP)ELISA Kit	96 Test	38220090	24,500.00
CLS0120CA	Canine Growth Differentiation Factor 8 (GDF8)ELISA kit	96 Test	38220090	24,500.00

Cat.No.	Product Description	Pack Size	HSN	Unit Price
CLS0121CA	Canine Heat Shock Protein 90kDa Beta 1 (HSP90b1)ELISA kit	96 Test	38220090	24,500.00
CLS0122CA	Canine Myostatin,MSTN ELISA Kit	96 Test	38220090	24,500.00
CLS0123CA	Canine C-C motif chemokine 26(CCL26) ELISA Kit	96 Test	38220090	24,500.00
CLS0124CA	Canine Mucosae associated epithelia chemokine,MEC/CCL28 ELISA Kit	96 Test	38220090	24,500.00
CLS0125CA	Canine Vitamin E,VE EELISA Kit	96 Test	38220090	24,500.00
CLS0126CA	Canine platelet-derived growth factor-BB,PDGF-BB ELISA Kit	96 Test	38220090	24,500.00
CLS0127CA	Canine Hemoglobin subunit alpha(HBA)ELISA Kit	96 Test	38220090	24,500.00
CLS0128CA	Canine Hemoglobin subunit beta(HBB) ELISA Kit	96 Test	38220090	24,500.00
CLS0129CA	Canine desmogleins 1,Dsg-1 ELISA Kit	96 Test	38220090	24,500.00
CLS0130CA	Canine Islet amyloid polypeptide,IAPP ELISA Kit	96 Test	38220090	24,500.00
CLS0131CA	Canine Platelet-Derived Growth Factor-B,PDGF-B ELISA kit	96 Test	38220090	24,500.00
CLS0132CA	Canine Lymphotoxin-alpha,LTA ELISA Kit	96 Test	38220090	24,500.00
CLS0133CA	Canine Secretin(SCT) ELISA Kit	96 Test	38220090	24,500.00
CLS0134CA	Canine Free Tri-iodothyronine Indes,Free-T3 ELISA Kit	96 Test	38220090	24,500.00
CLS0135CA	Canine cytochrome P450 2E1,CYP2E1 ELISA Kit	96 Test	38220090	24,500.00
CLS0136CA	Canine Testosterone,T ELISA Kit	96 Test	38220090	24,500.00
CLS0137CA	Canine Dihydrotestosterone,DHT ELISA Kit	96 Test	38220090	24,500.00
CLS0138CA	Canine Androgen receptor,AR ELISA Kit	96 Test	38220090	24,500.00
CLS0139CA	Canine progesterone receptor,PGR ELISA Kit	96 Test	38220090	24,500.00
CLS0140CA	Canine 17-Hydroxyprogesterone,17-OHP ELISA Kit	96 Test	38220090	24,500.00
CLS0141CA	Canine Angiotensin converting enzyme,ACE ELISA Kit	96 Test	38220090	24,500.00
CLS0142CA	Canine Interleukin 1 α ,IL-1 α ELISA Kit	96 Test	38220090	24,500.00
CLS0143CA	Canine Cytochrome P450 19A1,CYP19A1 ELISA Kit	96 Test	38220090	24,500.00
CLS0144CA	Canine trypsinogen activation peptide,TAP ELISA Kit	96 Test	38220090	24,500.00
CLS0145CA	Canine Proinsulin,PI ELISA Kit	96 Test	38220090	24,500.00
CLS0146CA	Canine DNA repair protein RAD51 homolog 1(RAD51) ELISA Kit	96 Test	38220090	24,500.00
CLS0147CA	Canine Apolipoprotein H/Beta-2-glycoprotein 1,Apo-H ELISA Kit	96 Test	38220090	24,500.00
CLS0148CA	Canine Eotaxin 2(CCL24) ELISA Kit	96 Test	38220090	24,500.00
CLS0149CA	Canine cardiac troponin I ,cTn- I ELISA Kit	96 Test	38220090	24,500.00
CLS0150CA	Canine Pancreatic Polypeptide,PP ELISA Kit	96 Test	38220090	24,500.00
CLS0151CA	Canine proteolipid protein,PLP ELISA Kit	96 Test	38220090	24,500.00
CLS0152CA	Canine high mobility group protein 17,HMG-17 ELISA Kit	96 Test	38220090	24,500.00
CLS0153CA	Canine Interleukin 33,IL-33 ELISA Kit	96 Test	38220090	24,500.00
CLS0154CA	Canine Vascular Endothelial cell Growth Factor A,VEGF-A ELISA KIT	96 Test	38220090	24,500.00
CLS0155CA	Canine adiponectin,ADP ELISA Kit	96 Test	38220090	24,500.00
CLS0156CA	Canine Tumor necrosis factor receptor superfamily member 5,CD40/TNFRSF5 ELISA Kit	96 Test	38220090	24,500.00
CLS0157CA	Canine Thymic stromal lymphopoietin,TSLP ELISA Kit	96 Test	38220090	24,500.00
CLS0158CA	Canine Endothelin-1 receptor,EDNRA ELISA Kit	96 Test	38220090	24,500.00
CLS0159CA	Canine Pulmonary surfatcant-associated protein A,SP-A ELISA Kit	96 Test	38220090	24,500.00
CLS0160CA	Canine Pulmonary surfatcant-associated protein B,SP-B ELISA Kit	96 Test	38220090	24,500.00
CLS0161CA	Canine Pulmonary surfatcant-associated protein C,SP-C ELISA Kit	96 Test	38220090	24,500.00
CLS0162CA	Canine Phosphofructokinase,PFK ELISA Kit	96 Test	38220090	24,500.00
CLS0163CA	Canine Immunoglobulin M,IgM ELISA Kit	96 Test	38220090	24,500.00
CLS0164CA	Canine Transcription factor 4,TCF-4 ELISA Kit	96 Test	38220090	24,500.00
CLS0165CA	Canine G1/S-specific Cyclin-D1,Cyclin-D1 ELISA Kit	96 Test	38220090	24,500.00
CLS0166CA	Canine Glutamate [NMDA] receptor subunit zeta-1,GRIN1 ELISA Kit	96 Test	38220090	24,500.00
CLS0167CA	Canine Endothelin 2,ET-2 ELISA Kit	96 Test	38220090	24,500.00

Cat.No.	Product Description	Pack Size	HSN	Unit Price
CLS0168CA	Canine Endothelin 3,ET-3 ELISA Kit	96 Test	38220090	24,500.00
CLS0169CA	Canine Breast cancer susceptibility protein 1,BRCA-1 ELISA Kit	96 Test	38220090	24,500.00
CLS0170CA	Canine Gonadotropin-releasing hormone receptor,GnRHR ELISA Kit	96 Test	38220090	24,500.00
CLS0171CA	Canine Collagen type I alpha 2,COL1A2/Collagen I ELISA Kit	96 Test	38220090	24,500.00
CLS0172CA	Canine Inward rectifier potassium channel 2,KCNJ2 ELISA Kit	96 Test	38220090	24,500.00
CLS0173CA	Canine Deoxyribonuclease 1,DNase-1 ELISA Kit	96 Test	38220090	24,500.00
CLS0174CA	Canine Glucagon,GC ELISA Kit	96 Test	38220090	24,500.00
CLS0175CA	Canine Rho Guanine Nucleotide Exchange Factor 2(ARHGEF2)ELISA Kit	96 Test	38220090	24,500.00
CLS0176CA	Canine Phosphatidylinositol-3,4,5-trisphosphate 3-phosphatase and dual-specificity protein phosphatase PTEN,PTEN ELISA kit	96 Test	38220090	24,500.00
CLS0177CA	Canine DNA-dependent protein kinase catalytic subunit,PRKDC ELISA Kit	96 Test	38220090	24,500.00
CLS0178CA	Canine Gastrin,GAS ELISA Kit	96 Test	38220090	24,500.00
CLS0179CA	Canine Annexin A4 (ANXA4)ELISA Kit	96 Test	38220090	24,500.00
CLS0180CA	Canine Telomerase reverse transcriptase,TERT ELISA Kit	96 Test	38220090	24,500.00
CLS0181CA	Canine Cysteinyl aspartate specific proteinases 3,Caspase-3/ CPP32 ELISA Kit	96 Test	38220090	24,500.00
CLS0182CA	Canine Neuromedin U (NMU)ELISA kit	96 Test	38220090	24,500.00
CLS0183CA	Canine Anti Muscle, Skeletal, Receptor Tyrosine Kinase Antibody(Anti MUSK)ELISA Kit	96 Test	38220090	24,500.00
CLS0001RB	Rabbit Vascuolar endothelial cell growth factor receptor 2(VEGFR-2/Flk-1)ELISA Kit	96 Test	38220090	24,500.00
CLS0002RB	Rabbit Transcription factor HES-2(HES2)ELISA Kit	96 Test	38220090	24,500.00
CLS0003RB	Rabbit Matrix metalloproteinase 9/Gelatinase A,MMP-9 ELISA Kit	96 Test	38220090	24,500.00
CLS0004RB	Rabbit Heparin-binding growth factor 1(FGF1)ELISA Kit	96 Test	38220090	24,500.00
CLS0005RB	Rabbit Transcription factor HES-1(HES1)ELISA Kit	96 Test	38220090	24,500.00
CLS0006RB	Rabbit Protein jagged-1(JAG1/CD339)ELISA Kit	96 Test	38220090	24,500.00
CLS0007RB	Rabbit Neurogenic locus notch homolog protein 1(NOTCH1)ELISA Kit	96 Test	38220090	24,500.00
CLS0008RB	Rabbit Neurogenic locus notch homolog protein 4(NOTCH4)ELISA Kit	96 Test	38220090	24,500.00
CLS0009RB	Rabbit Matrix metalloproteinase 2/Gelatinase A,MMP-2 ELISA Kit	96 Test	38220090	24,500.00
CLS0010RB	Rabbit Matrix metalloproteinase 3,MMP-3 ELISA kit	96 Test	38220090	24,500.00
CLS0011RB	Rabbit Interleukin 6,IL-6 ELISA Kit	96 Test	38220090	24,500.00
CLS0012RB	Rabbit Interleukin 1 β ,IL-1 β ELISA Kit	96 Test	38220090	24,500.00
CLS0013RB	Rabbit Interleukin 2,IL-2 ELISA Kit	96 Test	38220090	24,500.00
CLS0014RB	Rabbit Interleukin 22(IL-22)ELISA Kit	96 Test	38220090	24,500.00
CLS0015RB	Rabbit Interleukin 13(IL-13)ELISA Kit	96 Test	38220090	24,500.00
CLS0016RB	Rabbit Interleukin 5(IL-5)ELISA Kit	96 Test	38220090	24,500.00
CLS0017RB	Rabbit Prostaglandin E2(PGE2)ELISA Kit	96 Test	38220090	24,500.00
CLS0018RB	Rabbit Follistatin Like Protein 1(FSTL1)ELISA Kit	96 Test	38220090	24,500.00
CLS0019RB	Rabbit hydroxyproline(Hyp)ELISA Kit	96 Test	38220090	24,500.00
CLS0020RB	Rabbit Thyroid Stimulating Hormone(TSH)ELISA Kit	96 Test	38220090	24,500.00
CLS0021RB	Rabbit Thyroxine(T4)ELISA Kit	96 Test	38220090	24,500.00
CLS0022RB	Rabbit Glutathione Peroxidase(GPX)ELISA Kit	96 Test	38220090	24,500.00
CLS0023RB	Rabbit Catalase(CAT)ELISA Kit	96 Test	38220090	24,500.00
CLS0024RB	Rabbit Leptin(LEP)ELISA Kit	96 Test	38220090	24,500.00
CLS0025RB	Rabbit Tumor necrosis factor α ,TNF- α ELISA KIT	96 Test	38220090	24,500.00
CLS0026RB	Rabbit C-Reactive Protein,CRP ELISA Kit	96 Test	38220090	24,500.00
CLS0027RB	Rabbit Immunoglobulin M,IgM ELISA Kit	96 Test	38220090	24,500.00
CLS0028RB	Rabbit oxidized lowdensity lipoprotein,OxLDL ELISA Kit	96 Test	38220090	24,500.00
CLS0029RB	Rabbit Complement fragment 3a,C3a ELISA Kit	96 Test	38220090	24,500.00

Cat.No.	Product Description	Pack Size	HSN	Unit Price
CLS0030RB	Rabbit interleukin 12(IL-12/P70)ELISA Kit	96 Test	38220090	24,500.00
CLS0031RB	Rabbit Tri-iodothyronine(T3)ELISA Kit	96 Test	38220090	24,500.00
CLS0032RB	Rabbit Insulin Receptor(ISR)ELISA Kit	96 Test	38220090	24,500.00
CLS0033RB	Rabbit sorbitol dehydrogenase(SDH)ELISA Kit	96 Test	38220090	24,500.00
CLS0034RB	Rabbit gamma glutamyl transpeptidase(GGT)ELISA Kit	96 Test	38220090	24,500.00
CLS0035RB	Rabbit glucokinase(GCK)ELISA Kit	96 Test	38220090	24,500.00
CLS0036RB	Rabbit Bcl-2 associated X protein(BAX)ELISA Kit	96 Test	38220090	24,500.00
CLS0037RB	Rabbit cardiac troponin I ,cTn- I ELISA Kit	96 Test	38220090	24,500.00
CLS0038RB	Rabbit Creatine Kinase MB isoenzyme,CK-MB ELISA Kit	96 Test	38220090	24,500.00
CLS0039RB	Rabbit Cysteinyl aspartate specific proteinases 3,Caspase-3/ CPP32 ELISA Kit	96 Test	38220090	24,500.00
CLS0040RB	Rabbit Epidermal growth factor,EGF ELISA Kit	96 Test	38220090	24,500.00
CLS0041RB	Rabbit Glucose-6-phosphate 1- dehydrogenase(G6PD)ELISA kit	96 Test	38220090	24,500.00
CLS0042RB	Rabbit interleukin 8,IL-8 ELISA Kit	96 Test	38220090	24,500.00
CLS0043RB	Rabbit lipid peroxide,LPO ELISA Kit	96 Test	38220090	24,500.00
CLS0044RB	Rabbit Lipoprotein Associated Phospholipase A2(LP- PLA2) ELISA Kit	96 Test	38220090	24,500.00
CLS0045RB	Rabbit Thioredoxin-1(TRX-1)ELISA Kit	96 Test	38220090	24,500.00
CLS0046RB	Rabbit Thioredoxin-2(TRX-2)ELISA Kit	96 Test	38220090	24,500.00
CLS0047RB	Rabbit Transforming Growth factor β 1,TGF- β 1 ELISA kit	96 Test	38220090	24,500.00
CLS0048RB	Rabbit Troponin I (TN-I)ELISA Kit	96 Test	38220090	24,500.00
CLS0049RB	Rabbit Tyrosinase-Related Protein 1(TYRP1)ELISA Kit	96 Test	38220090	24,500.00
CLS0050RB	Rabbit Tyrosinase-Related Protein 2(TYRP2)ELISA Kit	96 Test	38220090	24,500.00
CLS0051RB	Rabbit Vascular Endothelial cell Growth Factor,VEGF ELISA Kit	96 Test	38220090	24,500.00
CLS0052RB	Rabbit Fibrinogen(Fbg)ELISA Kit	96 Test	38220090	24,500.00
CLS0053RB	Rabbit Platelet-Derived Growth Factor-BB,PDGF-BB ELISA kit	96 Test	38220090	24,500.00
CLS0054RB	Rabbit Fibronectin,FN ELISA Kit	96 Test	38220090	24,500.00
CLS0055RB	Rabbit Transforming Growth factor β ,TGF- β ELISA kit	96 Test	38220090	24,500.00
CLS0056RB	Rabbit N-terminal pro-brain peptide(NT-PROBNP)ELISA Kit	96 Test	38220090	24,500.00
CLS0057RB	Rabbit Myeloperoxidase(MPO)ELISA Kit	96 Test	38220090	24,500.00
CLS0058RB	Rabbit Super Oxidase Dimutase(SOD)ELISA Kit	96 Test	38220090	24,500.00
CLS0059RB	Rabbit insulin-like growth factors 1,IGF-1 ELISA Kit	96 Test	38220090	24,500.00
CLS0060RB	Rabbit Transforming Growth factor β 2,TGF- β 2 ELISA Kit	96 Test	38220090	24,500.00
CLS0061RB	Rabbit Platelet-Derived Growth Factor AA(PDGF-AA) ELISA Kit	96 Test	38220090	24,500.00
CLS0062RB	Rabbit Platelet-Derived Growth Factor AB,PDGF-AB ELISA kit	96 Test	38220090	24,500.00
CLS0063RB	Rabbit endothelium Selectin(E-Selectin)ELISA Kit	96 Test	38220090	24,500.00
CLS0064RB	Rabbit intercellular adhesion molecule 1(ICAM-1)ELISA Kit	96 Test	38220090	24,500.00
CLS0065RB	Rabbit Elastin(ELN)ELISA Kit	96 Test	38220090	24,500.00
CLS0066RB	Rabbit Glycosaminoglycans(GAGs)ELISA Kit	96 Test	38220090	24,500.00
CLS0067RB	Rabbit Interleukin 17,IL-17 ELISA KIT	96 Test	38220090	24,500.00
CLS0068RB	Rabbit Interleukin 21(IL-21)ELISA Kit	96 Test	38220090	24,500.00
CLS0069RB	Rabbit Hairy/enhancer-of-split related with YRPW motif protein 2(HEY2)ELISA Kit	96 Test	38220090	24,500.00
CLS0070RB	Rabbit Hairy/enhancer-of-split related with YRPW motif protein 1(HEY1)ELISA Kit	96 Test	38220090	24,500.00
CLS0071RB	Rabbit Delta Like 4 Homolog(DLK4)ELISA KIT	96 Test	38220090	24,500.00
CLS0072RB	Rabbit Delta Like 3 Homolog(DLK3)ELISA KIT	96 Test	38220090	24,500.00
CLS0073RB	Rabbit Delta Like 2 Homolog(DLK2)ELISA KIT	96 Test	38220090	24,500.00
CLS0074RB	Rabbit Delta Like 1 Homolog(DLK1)ELISA KIT	96 Test	38220090	24,500.00
CLS0075RB	Rabbit bone alkaline phosphatase,BALP ELISA Kit	96 Test	38220090	24,500.00
CLS0076RB	Rabbit Apolipoprotein B(APO-B)ELISA Kit	96 Test	38220090	24,500.00
CLS0077RB	Rabbit Apoprotein A1(APO-A1)ELISA Kit	96 Test	38220090	24,500.00
CLS0078RB	Rabbit Complement 4,C4 ELISA Kit	96 Test	38220090	24,500.00

Cat.No.	Product Description	Pack Size	HSN	Unit Price
CLS0079RB	Rabbit Complement 3,C3 ELISA Kit	96 Test	38220090	24,500.00
CLS0080RB	Rabbit Interferon γ ,IFN- γ ELISA Kit	96 Test	38220090	24,500.00
CLS0081RB	Rabbit Interleukin 1,IL-1 ELISA Kit	96 Test	38220090	24,500.00
CLS0082RB	Rabbit Interleukin 4,IL-4 ELISA Kit	96 Test	38220090	24,500.00
CLS0083RB	Rabbit Interleukin 10,IL-10 ELISA Kit	96 Test	38220090	24,500.00
CLS0084RB	Rabbit Paraoxonase-1,PON1 ELISA Kit	96 Test	38220090	24,500.00
CLS0085RB	Rabbit platelet-derived growth factor,PDGF ELISA Kit	96 Test	38220090	24,500.00
CLS0086RB	Rabbit Procalcitonin,PCT ELISA Kit	96 Test	38220090	24,500.00
CLS0087RB	Rabbit sphingosine 1 phosphate(S1P)ELISA Kit	96 Test	38220090	24,500.00
CLS0088RB	Rabbit Fibrinopeptide A,FPA ELISA Kit	96 Test	38220090	24,500.00
CLS0089RB	Rabbit Cortisol(COR) ELISA Kit	96 Test	38220090	24,500.00
CLS0090RB	Rabbit cyclooxygenase-2,COX-2 ELISA Kit	96 Test	38220090	24,500.00
CLS0091RB	Rabbit D-Dimer,D2D ELISA Kit	96 Test	38220090	24,500.00
CLS0092RB	Rabbit Estradiol,E2 ELISA Kit	96 Test	38220090	24,500.00
CLS0093RB	Rabbit Ghrelin(GHRL) ELISA Kit	96 Test	38220090	24,500.00
CLS0094RB	Rabbit Growth hormone releasing peptide-Ghrelin,GHRP Ghrelin ELISA Kit	96 Test	38220090	24,500.00
CLS0095RB	Rabbit Apolipoprotein B-48 (ApoB48) ELISA Kit	96 Test	38220090	24,500.00
CLS0096RB	Rabbit high density lipoprotein2,HDL2 ELISA Kit	96 Test	38220090	24,500.00
CLS0097RB	Rabbit high sensitivity C-Reactive Protein,hs-CRP ELISA Kit	96 Test	38220090	24,500.00
CLS0098RB	Rabbit Insulin,INS ELISA Kit	96 Test	38220090	24,500.00
CLS0099RB	Rabbit Interleukin 1 α ,IL-1 α ELISA Kit	96 Test	38220090	24,500.00
CLS0100RB	Rabbit Kidney injury molecule 1,Kim-1 ELISA Kit	96 Test	38220090	24,500.00
CLS0101RB	Rabbit malondialdehyde(MDA)ELISA Kit	96 Test	38220090	24,500.00
CLS0102RB	Rabbit Neuron-specific enolase,NSE ELISA Kit	96 Test	38220090	24,500.00
CLS0103RB	Rabbit Oxidized low-density lipoprotein receptor 1,OLR1/LOX1 ELISA kit	96 Test	38220090	24,500.00
CLS0104RB	Rabbit Pancreatic triacylglycerol lipase,PNLIP ELISA Kit	96 Test	38220090	24,500.00
CLS0105RB	Rabbit Prostaglandin E1,PG-E1 ELISA Kit	96 Test	38220090	24,500.00
CLS0106RB	Rabbit Regenerating Islet Derived Protein 1 Alpha(REG1a)ELISA Kit	96 Test	38220090	24,500.00
CLS0107RB	Rabbit Serum amyloid A,SAA ELISA Kit	96 Test	38220090	24,500.00
CLS0108RB	Rabbit Testosterone,T ELISA Kit	96 Test	38220090	24,500.00
CLS0109RB	Rabbit Thioredoxin,Trx ELISA Kit	96 Test	38220090	24,500.00
CLS0110RB	Rabbit 8-Hydroxy-desoxyguanosine,8-OHdG ELISA Kit	96 Test	38220090	24,500.00
CLS0111RB	Rabbit adiponectin,ADP ELISA Kit	96 Test	38220090	24,500.00
CLS0112RB	Rabbit Anti-OVA-IgE(Anti-OVA-IgE)ELISA Kit	96 Test	38220090	24,500.00
CLS0113RB	Rabbit Soluble Cluster of differentiation 40 ligand,sCD40L ELISA Kit	96 Test	38220090	24,500.00
CLS0114RB	Rabbit Asymmetrical dimethylarginine,ADMA ELISA Kit	96 Test	38220090	24,500.00
CLS0115RB	Rabbit Platelet-Derived Growth Factor-B,PDGF-B ELISA kit	96 Test	38220090	24,500.00
CLS0116RB	Rabbit fibroblast growth factor 2,FGF2 ELISA Kit	96 Test	38220090	24,500.00
CLS0117RB	Rabbit Gelsolin,GS ELISA Kit	96 Test	38220090	24,500.00
CLS0118RB	Rabbit glucokinase(GCK)ELISA Kit	96 Test	38220090	24,500.00
CLS0119RB	Rabbit Copeptin ELISA Kit	96 Test	38220090	24,500.00
CLS0120RB	Rabbit Heat Shock Protein 90kDa Alpha A1 (HSP90aA1)ELISA kit	96 Test	38220090	24,500.00
CLS0121RB	Rabbit Heat Shock Protein 90kDa Beta 1 (HSP90b1)ELISA kit	96 Test	38220090	24,500.00
CLS0122RB	Rabbit Hemoglobin subunit beta-1/2(HBB1) ELISA Kit	96 Test	38220090	24,500.00
CLS0123RB	Rabbit tissue inhibitors of metalloproteinase 4,TIMP-4 ELISA Kit	96 Test	38220090	24,500.00
CLS0124RB	Rabbit Transthyretin,TTR ELISA Kit	96 Test	38220090	24,500.00
CLS0125RB	Rabbit Islet amyloid polypeptide,IAPP ELISA Kit	96 Test	38220090	24,500.00
CLS0126RB	Rabbit Platelet-derived growth factor subunit A,PDGFA ELISA kit	96 Test	38220090	24,500.00
CLS0127RB	Rabbit Lymphotoxin-alpha,LTA ELISA Kit	96 Test	38220090	24,500.00

Cat.No.	Product Description	Pack Size	HSN	Unit Price
CLS0128RB	Rabbit Bactericidal permeability-increasing protein,BPI ELISA Kit	96 Test	38220090	24,500.00
CLS0129RB	Rabbit intestinal fatty acid binding protein,iFABP ELISA Kit	96 Test	38220090	24,500.00
CLS0130RB	Rabbit secretin receptor,SR ELISA Kit	96 Test	38220090	24,500.00
CLS0131RB	Rabbit cytochrome P450 2E1,CYP2E1 ELISA Kit	96 Test	38220090	24,500.00
CLS0132RB	Rabbit S100 Calcium Binding Protein A12 ,S100A12 ELISA Kit	96 Test	38220090	24,500.00
CLS0133RB	Rabbit Androgen receptor,AR ELISA Kit	96 Test	38220090	24,500.00
CLS0134RB	Rabbit Progesterone,PROG ELISA Kit	96 Test	38220090	24,500.00
CLS0135RB	Rabbit progesterone receptor,PGR ELISA Kit	96 Test	38220090	24,500.00
CLS0136RB	Rabbit Angiotensin converting enzyme,ACE ELISA Kit	96 Test	38220090	24,500.00
CLS0137RB	Rabbit Cytochrome P450 19A1,CYP19A1 ELISA Kit	96 Test	38220090	24,500.00
CLS0138RB	Rabbit cytochrome P450 7A1,CYP7A1 ELISA Kit	96 Test	38220090	24,500.00
CLS0139RB	Rabbit Neurokinins B,NKB ELISA Kit	96 Test	38220090	24,500.00
CLS0140RB	Rabbit Amylin ELISA Kit	96 Test	38220090	24,500.00
CLS0141RB	Rabbit DNA repair protein RAD51 homolog 1(RAD51) ELISA Kit	96 Test	38220090	24,500.00
CLS0142RB	Rabbit Glycated hemoglobin A1c,GHbA1c ELISA Kit	96 Test	38220090	24,500.00
CLS0143RB	Rabbit Troponin T, slow skeletal muscle(TNNT3) ELISA Kit	96 Test	38220090	24,500.00
CLS0144RB	Rabbit Troponin I, fast skeletal muscle(TNNI2) ELISA Kit	96 Test	38220090	24,500.00
CLS0145RB	Rabbit Histidine-proline-rich glycoprotein(HPRG) ELISA Kit	96 Test	38220090	24,500.00
CLS0146RB	Rabbit Secretin(SCT) ELISA Kit	96 Test	38220090	24,500.00
CLS0147RB	Rabbit Pancreatic Polypeptide,PP ELISA Kit	96 Test	38220090	24,500.00
CLS0148RB	Rabbit proteolipid protein,PLP ELISA Kit	96 Test	38220090	24,500.00
CLS0149RB	Rabbit Prostaglandin reductase 1,PTGR1 ELISA Kit	96 Test	38220090	24,500.00
CLS0150RB	Rabbit Signal peptide, CUB and EGF-like domain-containing protein 1(SCUBE1) ELISA Kit	96 Test	38220090	24,500.00
CLS0151RB	Rabbit secreted protein acidic and rich in cysteine,SPARC ELISA Kit	96 Test	38220090	24,500.00
CLS0152RB	Rabbit Endothelin 1,ET-1 ELISA Kit	96 Test	38220090	24,500.00
CLS0153RB	Rabbit Ryanodine receptor 1,RyR1 ELISA kit	96 Test	38220090	24,500.00
CLS0154RB	Rabbit Ryanodine receptor 2,RyR2 ELISA kit	96 Test	38220090	24,500.00
CLS0155RB	Rabbit Fructose-1,6-bisphosphatase 1,FBP1 ELISA kit	96 Test	38220090	24,500.00
CLS0156RB	Rabbit Platelet Factor 4,PF-4 ELISA Kit	96 Test	38220090	24,500.00
CLS0157RB	Rabbit Complement fragment 5a,C5a ELISA Kit	96 Test	38220090	24,500.00
CLS0158RB	Rabbit Glycogen synthase,GYS/GYS1 ELISA Kit	96 Test	38220090	24,500.00
CLS0159RB	Rabbit Pulmonary surfatcant-associated protein A,SP-A ELISA Kit	96 Test	38220090	24,500.00
CLS0160RB	Rabbit Pulmonary surfatcant-associated protein B,SP-B ELISA Kit	96 Test	38220090	24,500.00
CLS0161RB	Rabbit Pulmonary surfatcant-associated protein C,SP-C ELISA Kit	96 Test	38220090	24,500.00
CLS0162RB	Rabbit Phosphofructokinase,PFK ELISA Kit	96 Test	38220090	24,500.00
CLS0163RB	Rabbit 6-phosphofructokinase type C,PFKC ELISA Kit	96 Test	38220090	24,500.00
CLS0164RB	Rabbit Ischemia Modified Albumin,IMA ELISA Kit	96 Test	38220090	24,500.00
CLS0165RB	Rabbit immunoglobulin joining chain,Ig-j ELISA Kit	96 Test	38220090	24,500.00
CLS0166RB	Rabbit polymeric immunoglobulin receptor/secretory component,PIGR/SC ELISA Kit	96 Test	38220090	24,500.00
CLS0167RB	Rabbit Endothelin 2,ET-2 ELISA Kit	96 Test	38220090	24,500.00
CLS0168RB	Rabbit Endothelin 3,ET-3 ELISA Kit	96 Test	38220090	24,500.00
CLS0169RB	Rabbit 4-Hydroxynonenal,4HNE ELISA Kit	96 Test	38220090	24,500.00
CLS0170RB	Rabbit Collagen type I alpha 2,COL1A2/Collagen I ELISA Kit	96 Test	38220090	24,500.00
CLS0171RB	Rabbit Potassium channel subfamily K member 1,KCNK1 ELISA Kit	96 Test	38220090	24,500.00
CLS0172RB	Rabbit Vitamin D-binding protein,DBP ELISA Kit	96 Test	38220090	24,500.00

Cat.No.	Product Description	Pack Size	HSN	Unit Price
CLS0173RB	Rabbit ATP-sensitive inward rectifier potassium channel 11,KCNJ11/Kir6.2 ELISA Kit	96 Test	38220090	24,500.00
CLS0174RB	Rabbit Inward rectifier potassium channel 2,KCNJ2 ELISA Kit	96 Test	38220090	24,500.00
CLS0175RB	Rabbit Deoxyribonuclease 1, DNase-1 ELISA Kit	96 Test	38220090	24,500.00
CLS0176RB	Rabbit Cytochrome P450 1A1 (CYP1A1)ELISA kit	96 Test	38220090	24,500.00
CLS0177RB	Rabbit Glucagon,GC ELISA Kit	96 Test	38220090	24,500.00
CLS0178RB	Rabbit matrix metalloproteinase 12,MMP-12 ELISA kit	96 Test	38220090	24,500.00
CLS0179RB	Rabbit Acetylcholinesterase,AChE ELISA Kit	96 Test	38220090	24,500.00
CLS0180RB	Rabbit Brain natriuretic peptide,BNP ELISA Kit	96 Test	38220090	24,500.00
CLS0181RB	Rabbit Pyruvate kinase isozymes M1/M2,M2-PK ELISA Kit	96 Test	38220090	24,500.00
CLS0182RB	Rabbit S100 calcium binding protein A9/calgranulin B,S100A9 ELISA Kit	96 Test	38220090	24,500.00
CLS0183RB	Rabbit sex hormone-binding globulin,SHBG ELISA Kit	96 Test	38220090	24,500.00
CLS0184RB	Rabbit Hemopexin,HPX ELISA kit	96 Test	38220090	24,500.00
CLS0185RB	Rabbit Glutathione reductase(GR)ELISA kit	96 Test	38220090	24,500.00
CLS0186RB	Rabbit Glucose transporter 1, GLUT1/SLC2A1 ELISA Kit	96 Test	38220090	24,500.00
CLS0187RB	Rabbit Calpastatin/Calpain inhibitor,CAST ELISA Kit	96 Test	38220090	24,500.00
CLS0188RB	Rabbit Glucose-6-phosphate isomerase,GPI ELISA Kit	96 Test	38220090	24,500.00
CLS0189RB	Rabbit Retinal dehydrogenase 1,ALDH1A1 ELISA Kit	96 Test	38220090	24,500.00
CLS0190RB	Rabbit secretory immunoglobulin A,SIgA ELISA Kit	96 Test	38220090	24,500.00
CLS0191RB	Rabbit Transferrin(TRF)ELISA Kit	96 Test	38220090	24,500.00
CLS0192RB	Rabbit Alpha-1B-glycoprotein,A1BG ELISA Kit	96 Test	38220090	24,500.00
CLS0193RB	Rabbit vitronectin,VNR ELISA Kit	96 Test	38220090	24,500.00
CLS0194RB	Rabbit Fetuin A,FETU-A ELISA Kit	96 Test	38220090	24,500.00
CLS0195RB	Rabbit Annexin A1 (ANXA1)ELISA Kit	96 Test	38220090	24,500.00
CLS0196RB	Rabbit Annexin A6 (ANXA6)ELISA Kit	96 Test	38220090	24,500.00
CLS0197RB	Rabbit Triglyceride,TG ELISA Kit	96 Test	38220090	24,500.00
CLS0198RB	Rabbit Glutamate oxaloacetate transaminase 1,GOT1 ELISA Kit	96 Test	38220090	24,500.00
CLS0199RB	Rabbit Orosomucoid 1,ORM1/α1-AGP ELISA Kit	96 Test	38220090	24,500.00
CLS0200RB	Rabbit Adrenocorticotrophic hormone,ACTH ELISA Kit	96 Test	38220090	24,500.00
CLS0201RB	Rabbit Neuromedin U (NMU)ELISA kit	96 Test	38220090	24,500.00
CLS0001FI	Fish Testosterone,T ELISA Kit	96 Test	38220090	24,500.00
CLS0002FI	Fish Erythropoietin(EPO)ELISA Kit	96 Test	38220090	24,500.00
CLS0003FI	Fish Thyroxine,T4 ELISA KIT	96 Test	38220090	24,500.00
CLS0004FI	Fish tri-iodothyronine(T3)ELISA KIT	96 Test	38220090	24,500.00
CLS0005FI	Fish α-amylase(AMY)ELISA Kit	96 Test	38220090	24,500.00
CLS0006FI	Fish Interleukin 1(IL-1)ELISA Kit	96 Test	38220090	24,500.00
CLS0007FI	Fish Interleukin 4(IL-4)ELISA Kit	96 Test	38220090	24,500.00
CLS0008FI	Fish Insulin-like growth factor 1(IGF-1)ELISA Kit	96 Test	38220090	24,500.00
CLS0009FI	Fish 11-keto Testosterone(11-KETO-T) ELISA Kit	96 Test	38220090	24,500.00
CLS0010FI	Fish Estradiol(E2)ELISA Kit	96 Test	38220090	24,500.00
CLS0011FI	Fish Cortisol(COR) ELISA Kit	96 Test	38220090	24,500.00
CLS0012FI	Fish Alkaline Phosphatase(ALP)ELISA Kit	96 Test	38220090	24,500.00
CLS0013FI	Fish Immunoglobulin M(IgM)ELISA Kit	96 Test	38220090	24,500.00
CLS0014FI	Fish Catalase (CAT)ELISA Kit	96 Test	38220090	24,500.00
CLS0015FI	Fish Super Oxidase Dimutase,SOD ELISA Kit	96 Test	38220090	24,500.00
CLS0016FI	Fish Heat Shock Protein 70(HSP-70)ELISA Kit	96 Test	38220090	24,500.00
CLS0017FI	Fish Interleukin 6(IL-6)ELISA Kit	96 Test	38220090	24,500.00
CLS0018FI	Fish Glutathione peroxidase 1(GPx-1)ELISA Kit	96 Test	38220090	24,500.00
CLS0019FI	Fish Lipid Peroxide,LPO ELISA KIT	96 Test	38220090	24,500.00
CLS0020FI	Fish lysozyme(LZM)ELISA Kit	96 Test	38220090	24,500.00
CLS0021FI	Fish dopamine(DA)ELISA KIT	96 Test	38220090	24,500.00
CLS0022FI	Fish leptin(LEP) ELISA Kit	96 Test	38220090	24,500.00
CLS0023FI	Fish Melatonin(MT) ELISA Kit	96 Test	38220090	24,500.00
CLS0024FI	Fish Ethoxyresorufin-O-deethylase(EROD)ELISA Kit	96 Test	38220090	24,500.00
CLS0025FI	Fish Aromatase(ARO)ELISA Kit	96 Test	38220090	24,500.00

Cat.No.	Product Description	Pack Size	HSN	Unit Price
CLS0026FI	Fish Vitellogenin,VTG ELISA Kit	96 Test	38220090	24,500.00
CLS0027FI	Fish Interleukin 1β(IL-1β)ELISA Kit	96 Test	38220090	24,500.00
CLS0028FI	Fish Acid Phosphatase(ACP)ELISA Kit	96 Test	38220090	24,500.00
CLS0029FI	Fish Phenol oxidase(PO)ELISA Kit	96 Test	38220090	24,500.00
CLS0030FI	Fish 17beta-estradiol,E2 ELISA Kit	96 Test	38220090	24,500.00
CLS0031FI	Fish Interleukin 21(IL-21)ELISA Kit	96 Test	38220090	24,500.00
CLS0032FI	Fish Interleukin 8(IL-8)ELISA Kit	96 Test	38220090	24,500.00
CLS0033FI	Fish 17alpha, 20beta dihydroxyprogesterone (17α,20βOH-PROG)ELISA Kit	96 Test	38220090	24,500.00
CLS0034FI	Fish Vitamin K(VK)ELISA Kit	96 Test	38220090	24,500.00
CLS0035FI	Fish Acetylcholinesterase,AChE ELISA Kit	96 Test	38220090	24,500.00
CLS0036FI	Fish Cytochrome P450 1A1(CYP1A1)ELISA Kit	96 Test	38220090	24,500.00
CLS0037FI	Fish glutathione S-transferases,GSTs ELISA Kit	96 Test	38220090	24,500.00
CLS0038FI	Fish Progesterone,PROG ELISA Kit	96 Test	38220090	24,500.00
CLS0039FI	Fish Glutathione peroxidase(GPX)ELISA Kit	96 Test	38220090	24,500.00
CLS0040FI	Fish Luteinizing Hormone(LH)ELISA Kit	96 Test	38220090	24,500.00
CLS0041FI	Fish Follicle-stimulating hormone(FSH)ELISA Kit	96 Test	38220090	24,500.00
CLS0042FI	Fish cyclic adenosine monophosphate(cAMP)ELISA Kit	96 Test	38220090	24,500.00
CLS0043FI	Fish Prostaglandin E2(PGE2)ELISA Kit	96 Test	38220090	24,500.00
CLS0044FI	Fish Interferon γ(IFN-γ)ELISA Kit	96 Test	38220090	24,500.00
CLS0045FI	Fish Gonadotropin-releasing hormone(GNRH)ELISA Kit	96 Test	38220090	24,500.00
CLS0046FI	Fish Histamine(HIS)ELISA Kit	96 Test	38220090	24,500.00
CLS0047FI	Fish Vitamin E(VE)ELISA Kit	96 Test	38220090	24,500.00
CLS0048FI	Fish Vitamin D(VD)ELISA Kit	96 Test	38220090	24,500.00
CLS0049FI	Fish Pepsin(PP)ELISA Kit	96 Test	38220090	24,500.00
CLS0050FI	Fish Chymotrypsin(Chymotrypsin)ELISA Kit	96 Test	38220090	24,500.00
CLS0051FI	Fish Trypsin(Trypsin)ELISA Kit	96 Test	38220090	24,500.00
CLS0052FI	Fish Thyroid Stimulating Hormone(TSH)ELISA Kit	96 Test	38220090	24,500.00
CLS0053FI	Fish Tumor necrosis factor α(TNF-α)ELISA Kit	96 Test	38220090	24,500.00
CLS0054FI	Fish Metallothionein,MT ELISA Kit	96 Test	38220090	24,500.00
CLS0055FI	Fish Prostaglandin F2α,PGF2α ELISA Kit	96 Test	38220090	24,500.00
CLS0056FI	Fish Cytochrome-C,Cyt-C ELISA Kit	96 Test	38220090	24,500.00
CLS0057FI	Fish Growth hormone(GH)ELISA Kit	96 Test	38220090	24,500.00
CLS0058FI	Fish Complement 4(C4)ELISA Kit	96 Test	38220090	24,500.00
CLS0059FI	Fish Corticosterone(CORT)ELISA Kit	96 Test	38220090	24,500.00
CLS0060FI	Fish Cytochrome P450,CYP450 ELISA Kit	96 Test	38220090	24,500.00
CLS0061FI	Fish Aldosterone(ALD)ELISA Kit	96 Test	38220090	24,500.00
CLS0062FI	Fish Androstenedione,ASD ELISA Kit	96 Test	38220090	24,500.00
CLS0063FI	Fish Complement 3(C3)ELISA Kit	96 Test	38220090	24,500.00
CLS0064FI	Fish Adrenocorticotrophic hormone(ACTH)ELISA Kit	96 Test	38220090	24,500.00
CLS0065FI	Fish 17-Hydroxyprogesterone,17-OHP ELISA Kit	96 Test	38220090	24,500.00
CLS0066FI	Fish malondialdehyde,MDA ELISA Kit	96 Test	38220090	24,500.00
CLS0067FI	Fish Free Tri-iodothyronine Indes,Free-T3 ELISA Kit	96 Test	38220090	24,500.00
CLS0068FI	Fish Free Thyroxine,FT4 ELISA Kit	96 Test	38220090	24,500.00
CLS0069FI	Fish Angiotensin converting enzyme,ACE ELISA Kit	96 Test	38220090	24,500.00
CLS0001MK	Monkey tissue inhibitors of metalloproteinase 1(TIMP-1)ELISA Kit	96 Test	38220090	24,500.00
CLS0002MK	Monkey neutrophil gelatinase-associated lipocalin(NGAL)ELISA Kit	96 Test	38220090	24,500.00
CLS0003MK	Monkey matrix metalloproteinase(MMP-7)ELISA Kit	96 Test	38220090	24,500.00
CLS0004MK	Monkey S100 calcium binding protein A4(S100A4)ELISA Kit	96 Test	38220090	24,500.00
CLS0005MK	Monkey 2,5-oligoadenylate synthetase(2,5-OAS) ELISA Kit	96 Test	38220090	24,500.00
CLS0006MK	Monkey Histamine,HIS ELISA Kit	96 Test	38220090	24,500.00
CLS0007MK	Monkey Complement fragment 3a,C3a ELISA Kit	96 Test	38220090	24,500.00
CLS0008MK	Monkey Complement fragment 5a,C5a ELISA Kit	96 Test	38220090	24,500.00
CLS0009MK	Monkey adiponectin,ADP ELISA Kit	96 Test	38220090	24,500.00
CLS0010MK	Monkey Insulin,INS ELISA KIT	96 Test	38220090	24,500.00

Cat.No.	Product Description	Pack Size	HSN	Unit Price
CLS0011MK	Monkey Dihydrotestosterone,DHT ELISA Kit	96 Test	38220090	24,500.00
CLS0012MK	Monkey Testosterone,T ELISA Kit	96 Test	38220090	24,500.00
CLS0013MK	Monkey mast cell tryptase(MCT)ELISA Kit	96 Test	38220090	24,500.00
CLS0014MK	Monkey Prolactin(PRL)ELISA Kit	96 Test	38220090	24,500.00
CLS0015MK	Monkey Interleukin 17(IL-17)ELISA Kit	96 Test	38220090	24,500.00
CLS0016MK	Monkey Apolipoprotein C3,Apo C3 ELISA Kit	96 Test	38220090	24,500.00
CLS0017MK	Monkey Hyaluronic acid,HA ELISA Kit	96 Test	38220090	24,500.00
CLS0018MK	Monkey Cortisol(COR) ELISA Kit	96 Test	38220090	24,500.00
CLS0019MK	Monkey Substance P(SP)ELISA Kit	96 Test	38220090	24,500.00
CLS0020MK	Monkey TEK tyrosine kinase,Endothelial,Tie2 ELISA Kit	96 Test	38220090	24,500.00
CLS0021MK	Monkey Prostaglandin E2,PG-E2 ELISA Kit	96 Test	38220090	24,500.00
CLS0022MK	Monkey Progesterone,PROG ELISA Kit	96 Test	38220090	24,500.00
CLS0023MK	Monkey Hemoglobin subunit beta(HBB) ELISA Kit	96 Test	38220090	24,500.00
CLS0024MK	Monkey transforming growth factor α ,TGF- α ELISA Kit	96 Test	38220090	24,500.00
CLS0025MK	Monkey transforming growth factor β ,TGF- β ELISA Kit	96 Test	38220090	24,500.00
CLS0026MK	Monkey Lymphotoxin-beta,LTB ELISA Kit	96 Test	38220090	24,500.00
CLS0027MK	Monkey Glutathione reductase(GR)ELISA kit	96 Test	38220090	24,500.00
CLS0028MK	Monkey secretory immunoglobulin A,SIgA ELISA Kit	96 Test	38220090	24,500.00
CLS0029MK	Monkey Microalbuminuria,MAU/ALB ELISA Kit	96 Test	38220090	24,500.00
CLS0001HO	Horse Chorionic Gonadotropin(CG)ELISA Kit	96 Test	38220090	24,500.00
CLS0002HO	Horse Beta-Endorphin, β -EP ELISA Kit	96 Test	38220090	24,500.00
CLS0003HO	Horse Ghrelin(GHRL)ELISA Kit	96 Test	38220090	24,500.00
CLS0004HO	Horse non-ester fatty acid(NEFA)ELISA Kit	96 Test	38220090	24,500.00
CLS0005HO	Horse Haptoglobin(Hpt)ELISA Kit	96 Test	38220090	24,500.00
CLS0006HO	Horse Serum amyloid A(SAA)ELISA Kit	96 Test	38220090	24,500.00
CLS0007HO	Horse major acute phase protein(MAP)ELISA Kit	96 Test	38220090	24,500.00
CLS0008HO	Horse Electrogenic Sodium Bicarbonate Cotransporter 4(NBC4)ELISA Kit	96 Test	38220090	24,500.00
CLS0009HO	Horse Cardiac troponin I (cTn- I)ELISA Kit	96 Test	38220090	24,500.00
CLS0010HO	Horse Brain natriureti peptide(BNP)ELISA Kit	96 Test	38220090	24,500.00
CLS0011HO	Horse Atrial Natriuretic Peptide(ANP)ELISA Kit	96 Test	38220090	24,500.00
CLS0012HO	Horse Parathyroid hormone(PTH)ELISA Kit	96 Test	38220090	24,500.00
CLS0013HO	Horse Immunoglobulin M(IgM)ELISA Kit	96 Test	38220090	24,500.00
CLS0014HO	Horse Immunoglobulin G(IgG)ELISA Kit	96 Test	38220090	24,500.00
CLS0015HO	Horse Immunoglobulin A(IgA)ELISA Kit	96 Test	38220090	24,500.00
CLS0016HO	Horse Vitamin E(VE)ELISA Kit	96 Test	38220090	24,500.00
CLS0017HO	Horse Vitamin A(VA)ELISA Kit	96 Test	38220090	24,500.00
CLS0018HO	Horse tumor necrosis factor α (TNF- α)ELISA Kit	96 Test	38220090	24,500.00
CLS0019HO	Horse Interleukin 6(IL-6)ELISA Kit	96 Test	38220090	24,500.00
CLS0020HO	Horse Adrenocorticotrophic hormone(ACTH)ELISA Kit	96 Test	38220090	24,500.00
CLS0021HO	Horse Insulin(INS)ELISA Kit	96 Test	38220090	24,500.00
CLS0022HO	Horse Visfatin(Visfatin)ELISA Kit	96 Test	38220090	24,500.00
CLS0023HO	Horse 17beta-estradiol,E2 ELISA Kit	96 Test	38220090	24,500.00
CLS0024HO	Horse Activin A,ACV-A ELISA Kit	96 Test	38220090	24,500.00
CLS0025HO	Horse Adenosine triphosphate(ATP) ELISA Kit	96 Test	38220090	24,500.00
CLS0026HO	Horse Cortisol(COR) ELISA Kit	96 Test	38220090	24,500.00
CLS0027HO	Horse Follistatin,FS ELISA Kit	96 Test	38220090	24,500.00
CLS0028HO	Horse insulin-like growth factors 1,IGF-1 ELISA Kit	96 Test	38220090	24,500.00
CLS0029HO	Horse Progesterone,PROG ELISA Kit	96 Test	38220090	24,500.00
CLS0030HO	Horse Vascular Endothelial cell Growth Factor,VEGF ELISA Kit	96 Test	38220090	24,500.00
CLS0031HO	Horse platelet-derived growth factor-BB,PDGF-BB ELISA Kit	96 Test	38220090	24,500.00
CLS0032HO	Horse Hemoglobin subunit beta(HBB) ELISA Kit	96 Test	38220090	24,500.00
CLS0033HO	Horse Testosterone,T ELISA Kit	96 Test	38220090	24,500.00
CLS0034HO	Horse Dihydrotestosterone,DHT ELISA Kit	96 Test	38220090	24,500.00
CLS0035HO	Horse 17-Hydroxyprogesterone,17-OHP ELISA Kit	96 Test	38220090	24,500.00
CLS0036HO	Horse Hyaluronic acid,HA ELISA Kit	96 Test	38220090	24,500.00
CLS0037HO	Horse Glutathione reductase(GR)ELISA kit	96 Test	38220090	24,500.00

Cat.No.	Product Description	Pack Size	HSN	Unit Price
CLS0038HO	Horse Inhibin,INH-A ELISA Kit	96 Test	38220090	24,500.00
CLS0039HO	Horse Retinal dehydrogenase 1,ALDH1A1 ELISA Kit	96 Test	38220090	24,500.00
CLS0001CM	Camel Parathyroid homone(PTH)ELISA Kit	96 Test	38220090	24,500.00
CLS0002CM	Camel Serum amyloid A(SAA)ELISA Kit	96 Test	38220090	24,500.00
CLS0003CM	Camel α1-Acid glycoprotein(α1-AGP)ELISA Kit	96 Test	38220090	24,500.00
CLS0004CM	Camel albumin(albumin)ELISA Kit	96 Test	38220090	24,500.00
CLS0005CM	Camel lactoferrin(LTF/LF)ELISA Kit	96 Test	38220090	24,500.00
CLS0006CM	Camel Progesterone,PROG ELISA Kit	96 Test	38220090	24,500.00
CLS0001BI	Bird Melatonin(MT)ELISA Kit	96 Test	38220090	24,500.00
CLS0002BI	Bird Tumor necrosis factor α(TNF-α)ELISA Kit	96 Test	38220090	24,500.00
CLS0003BI	Bird Interferon gamma(IFN-γ)ELISA Kit	96 Test	38220090	24,500.00
CLS0004BI	Bird Interleukin 1 beta(IL-1b)ELISA Kit	96 Test	38220090	24,500.00
CLS0005BI	Bird Corticosterone(CORT)ELISA Kit	96 Test	38220090	24,500.00
CLS0006BI	Bird Testosterone(T)ELISA Kit	96 Test	38220090	24,500.00
CLS0007BI	Bird Estradiol(E2)ELISA Kit	96 Test	38220090	24,500.00
CLS0008BI	Bird Tri-iodothyronine(T3)ELISA Kit	96 Test	38220090	24,500.00
CLS0009BI	Bird thyroxine(T4)ELISA Kit	96 Test	38220090	24,500.00
CLS0010BI	Bird Immunoglobulin(IgA)ELISA Kit	96 Test	38220090	24,500.00
CLS0011BI	Bird Interleukin 2(IL-2)ELISA Kit	96 Test	38220090	24,500.00
CLS0012BI	Bird Immunoglobulin G(IgG)ELISA Kit	96 Test	38220090	24,500.00
CLS0013BI	Bird Interleukin 6(IL-6)ELISA Kit	96 Test	38220090	24,500.00
CLS0001DU	Duck Interferon γ(IFN-γ)ELISA Kit	96 Test	38220090	24,500.00
CLS0002DU	Duck Interleukin 2(IL-2)ELISA Kit	96 Test	38220090	24,500.00
CLS0003DU	Duck Interleukin 6(IL-6)ELISA Kit	96 Test	38220090	24,500.00
CLS0004DU	Duck Tumor necrosis factor α(TNF-α)ELISA Kit	96 Test	38220090	24,500.00
CLS0005DU	Duck Progesterone,PROG ELISA Kit	96 Test	38220090	24,500.00
CLS0001PL	Plant Vitamin B6,VB6 ELISA Kit	96 Test	38220090	24,500.00
CLS0002PL	Plant Vitamin E,VE ELISA Kit	96 Test	38220090	24,500.00
CLS0003PL	Plant hormone abscisic acid(ABA)ELISA Kit	96 Test	38220090	24,500.00
CLS0004PL	Plant Cytokinin,CYT ELISA Kit	96 Test	38220090	24,500.00
CLS0005PL	Plant Gibberellic Acid(GA) ELISA Kit	96 Test	38220090	24,500.00
CLS0006PL	Plant L-ascorbate peroxidase 2, cytosolic(APX2) ELISA Kit	96 Test	38220090	24,500.00
CLS0007PL	Plant (grass) ibulose-1,5-bisphosphate carboxylase/oxygenase(RuBisCO)ELISA Kit	96 Test	38220090	24,500.00
CLS0008PL	Plant Indole acetic acid,IAA ELISA Kit	96 Test	38220090	24,500.00
CLS0009PL	Plant Abscisic acid,ABA ELISA Kit	96 Test	38220090	24,500.00
CLS0010PL	Plant Calmodulin,CAM ELISA Kit	96 Test	38220090	24,500.00
CLS0011PL	Plant Vitamin B12,VB12 ELISA Kit	96 Test	38220090	24,500.00
CLS0001WH	Whale Progesterone,PROG ELISA Kit	96 Test	38220090	24,500.00
CLS0001EH	Elephant Testosterone,T ELISA Kit	96 Test	38220090	24,500.00
CLS0001GI	Giraffe lactoferrin(LTF/LF)ELISA Kit	96 Test	38220090	24,500.00
CLS0002GI	Giraffe albumin(albumin)ELISA Kit	96 Test	38220090	24,500.00
CLS0005M	HA-tag (4G3) monoclonal antibody	50ul	38220090	18,870.00
CLS0005MH	HA-tag (4G3) monoclonal antibody-HRP	50ul	38220090	18,870.00
CLS0007M	Flag-tag (1A8) monoclonal antibody	50ul	38220090	18,870.00
CLS0007MH	Flag-tag (1A8) monoclonal antibody-HRP	50ul	38220090	18,870.00
CLS0031M	Myc-tag (5D10) monoclonal antibody	50ul	38220090	18,870.00
CLS0032M	His-tag (4C2) monoclonal antibody	50ul	38220090	18,870.00
CLS0675M	GFP-tag (3A10) monoclonal antibody	50ul	38220090	18,870.00
CLS0675MH	GFP-tag (3A10) monoclonal antibody-HRP	50ul	38220090	18,870.00
CLS1482M	Tubulin β (4D9) monoclonal antibody	50ul	38220090	18,870.00
CLS1482MH	Tubulin β (4D9) monoclonal antibody-HRP	50ul	38220090	18,870.00
CLS001	GAPDH (1A6) monoclonal antibody	50ul	38220090	18,870.00
CLS001H	GAPDH (1A6) monoclonal antibody-HRP	50ul	38220090	18,870.00
CLS2001	C-Myc-Tag Mouse monoclonal antibody	50ul	38220090	18,870.00
CLS2002	E2-Tag Mouse monoclonal antibody	50ul	38220090	18,870.00
CLS2003	Flag-Tag Mouse monoclonal antibody	50ul	38220090	18,870.00

Terms and Conditions of Sale

1. The Price list includes 'CLS' Brand products and products from other manufacturers.
2. All prices are FOR destination by Road Transport only.
3. GST will be charged extra as applicable at the time of billing.
4. Prices are inclusive of Excise Duty where applicable.
5. The price for items of special requirement will be quoted on request.
6. This cancels all our previous price list.
7. The prices are Ex Works.
8. Our responsibility ceases once we deliver the goods to the carrier.
9. All disputes shall be within the competent courts in Our Regd. Office only.
10. Goods will be dispatched in standard packing or multiple thereof.
11. Capacity measures are for laboratory use only and not for Commercial use.
12. The company reserves the right to change colour and modify the design of the product.
13. The pricelist is effective from 1st April 2018.

Liability & Warranty :

We believe that the information we provide to you in our General Catalog and also the information provided with

CLS Products is correct and reliable to best of our knowledge and belief. We assure and make sure that products we provide you are free from manufacturing defects an we will replace any product that are found to be defective against any manufacturing defect at no cost.

CLS BRAND products. Is liable exclusively and restrictively to replace defective products but under no circumstances CLS is liable for any kind of damage rising from its products.

Details of our Bank
Account Name: Composite Lab Line Pvt Ltd.
Branch Name: HDFC Bank, Indra Nagar, Lucknow.
RTGS/IFSC No. HDFC0000296
A/C No. 02962320001403

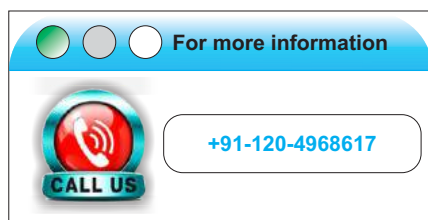

COPYRIGHT WARNING !

The Data, Pictures accompanying this Catalog/Price List are Copyrighted and owned by CLS PRODUCTS BRAND and its partners overseas. Protected under applicable Indian and international copyright laws. Further Use of Data/Pictures without informing CLS is Strictly prohibited



Corporate Office

Corporate Office

Regd Office



Plant

Ware House - 01st

Ware House - 02nd

Ware House - 03rd



COMPOSITE LAB LINE PVT LTD

Lab Equipment's, Lab Essentials, Glassware's, Plastic ware's and Modular Lab Furniture

Corporate Office

UGSR-1, Ansal Plaza, Vaishali Delhi, NCR, Ghaziabad - 201010 (India)

Ph. : 0120-4335636, Mail : sales@compositelabline.com

www.compositelabline.com

Regd Office

A-1, OKKP Complex, Near I.T. Collage Crossing Faizabad Road, Babujanj,
Lucknow - 226020 (India) Ph.: +91 9580613355, 0522-4068342